

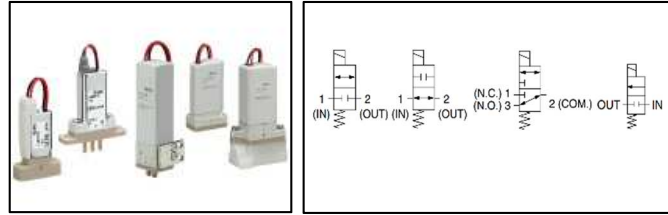

ORIGINAL INSTRUCTIONS

Instruction Manual

2/3 Port Solenoid valve for Chemical Liquids  
LVM Series



The intended use of this product is for the control of the downstream fluid supply.

1 Safety Instructions

These safety instructions are intended to prevent hazardous situations and/or equipment damage. These instructions indicate the level of potential hazard with the labels of "Caution," "Warning" or "Danger." They are all important notes for safety and must be followed in addition to International Standards (ISO/IEC)<sup>(1)</sup>, and other safety regulations.

- <sup>(1)</sup> ISO 4414: Pneumatic fluid power - General rules relating to systems.
- ISO 4413: Hydraulic fluid power - General rules relating to systems.
- IEC 60204-1: Safety of machinery - Electrical equipment of machines. (Part 1: General requirements)
- ISO 10218-1: Manipulating industrial robots - Safety, etc.

- Refer to product catalogue, Operation Manual and Handling Precautions for SMC Products for additional information.
- Keep this manual in a safe place for future reference.

**Caution** Caution indicates a hazard with a low level of risk which, if not avoided, could result in minor or moderate injury.

**Warning** Warning indicates a hazard with a medium level of risk which, if not avoided, could result in death or serious injury.

**Danger** Danger indicates a hazard with a high level of risk which, if not avoided, will result in death or serious injury.

**Warning**

- Always ensure compliance with relevant safety laws and standards.
- All work must be carried out in a safe manner by a qualified person in compliance with applicable national regulations.

2 Specifications

2.1 General Specifications LVM07

Model	Base mounted
	LVM07R6
Valve Construction	Direct operated rocker Type
Valve type	N.C.
Number of ports	2
Fluid <sup>1)</sup>	Air, Water, DI water, Diluent, Cleaning fluid
Operating pressure range	-75 kPa to 0.1 MPa
Orifice diameter	0.8 mm
Response time <sup>5)</sup>	10 ms or less
Leakage	Zero leakage (at water pressure)
Proof pressure <sup>2)</sup>	0.15 MPa
Ambient Temperature <sup>6)</sup>	0 to 50°C
Fluid Temperature <sup>6)</sup>	0 to 50°C (No Freezing)
Valve chamber volume <sup>3)</sup>	8 µL
Mounting orientation <sup>4)</sup>	Free
Enclosure	IP40 or equivalent
Weight	7 g

2 Specification - continued

Rated Voltage	12, 24 VDC		
Voltage fluctuation <sup>7)</sup>	±10% of rated voltage		
Type of coil insulation	Class B		
Power Consumption (When rated voltage is 24V)	Standard <sup>*</sup>	2.8 W (0.12 A)	
	With power saving	Inrush	2.8 W (0.12 A)
		Holding	0.8 W
Coil switching noise <sup>8)</sup>	50 dB		

Table 1

\* The LVM07R6 (standard type) requires power saving control. Implement power saving control according to Figure 1

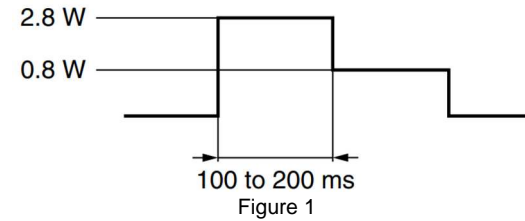

2.1 General Specifications LVM09/090

Model	Body Ported		
	LVM09R1	LVM09R2	
Valve construction	Direct operated rocker type		
Valve type	N.C.	N.O.	
Number of ports	2		
Fluid <sup>1)</sup>	Air, Water, DI water, Diluent, Cleaning fluid		
Operating pressure range	-75 kPa to 0.2 MPa		
Orifice diameter	1 mm		
Response time <sup>5)</sup>	10 ms or less (air)		
Leakage	Zero leakage (at water pressure)		
Proof pressure <sup>2)</sup>	0.3 MPa		
Ambient Temperature <sup>6)</sup>	0 to 50°C		
Fluid Temperature <sup>6)</sup>	0 to 50°C (No Freezing)		
Valve chamber volume <sup>3)</sup>	18 µL		
Mounting orientation <sup>4)</sup>	Free		
Enclosure	IP40 or equivalent		
Weight	22 g		
Rated Voltage	12, 24 VDC		
Voltage fluctuation <sup>7)</sup>	±10% of rated voltage		
Type of coil insulation	Class B		
Power Consumption (When rated voltage is 24V)	Standard	2 W (0.08 A)	
	Power Saving	Inrush	3.3 W (0.14 A)
		Holding	0.9 W
Coil switching noise <sup>8)</sup>	50 dB		

Table 2

2 Specification - continued

Model	Base Mounted		
	LVM09R3	LVM09R4	LVM09R6
Valve construction	Direct operated rocker type		
Valve type	N.C.	N.O.	N.C.
Number of ports	2		
Fluid <sup>1)</sup>	Air, Water, DI water, Diluent, Cleaning fluid		
Operating pressure	-75 kPa to 0.2 MPa		
Orifice diameter	1.1 mm		
Response time <sup>5)</sup>	10 ms or less (air)		
Leakage	Zero leakage (at water pressure)		
Proof pressure <sup>2)</sup>	0.3 MPa		
Ambient Temperature <sup>6)</sup>	0 to 50°C		
Fluid Temperature <sup>6)</sup>	0 to 50°C (No Freezing)		
Valve chamber volume <sup>3)</sup>	18 µL	29 µL	
Mounting orientation <sup>4)</sup>	Free		
Enclosure	IP40 or equivalent		
Weight	20 g		
Rated Voltage	12, 24 VDC		
Voltage fluctuation <sup>7)</sup>	±10% of rated voltage		
Type of coil insulation	Class B		
Power Consumption (When rated voltage is 24V)	Standard	2 W (0.08 A)	
	Power Saving	In-rush	3.3 W (0.14 A)
		Hold-ing	0.9 W
Coil switching noise <sup>8)</sup>	50 dB		

Table 3

Model	Body ported	Base mounted	
	LVM092R	LVM095R	
Valve construction	Direct operated rocker type		
Valve type	Universal		
Number of ports	3		
Fluid <sup>1)</sup>	Air, Water, DI water, Diluent, Cleaning fluid		
Operating pressure	-75 kPa to 0.2 MPa		
Orifice diameter	1 mm	1.1 mm	
Response time <sup>5)</sup>	10 ms or less (air)		
Leakage	Zero leakage (at water pressure)		
Proof pressure <sup>2)</sup>	0.3 MPa		
Ambient Temperature <sup>6)</sup>	0 to 50°C		
Fluid Temperature <sup>6)</sup>	0 to 50°C (No Freezing)		
Valve chamber volume <sup>3)</sup>	18 µL		
Mounting orientation <sup>4)</sup>	Free		
Enclosure	IP40 or equivalent		
Weight	22 g	20 g	
Rated Voltage	12, 24 VDC		
Voltage fluctuation <sup>7)</sup>	±10% of rated voltage		
Type of coil insulation	Class B		
Power Consumption (When rated voltage is 24V)	Standard	2 W (0.08 A)	
	Power Saving	Inrush	3.3 W (0.14 A)
		Holding	0.9 W
Coil switching noise <sup>8)</sup>	50 dB		

Table 4

2 Specification - continued

2.2 General Specifications LVM10/100

Model	Body Ported		
	LVM10R1	LVM10R2	
Valve construction	Direct operated rocker type		
Valve type	N.C.	N.O.	
Number of ports	2		
Fluid <sup>1)</sup>	Air, Water, DI water, Diluent, Cleaning fluid		
Operating pressure range	-75 kPa to 0.25 MPa		
Orifice diameter	1.4 mm		
Response time <sup>5)</sup>	10 ms or less (air)		
Leakage	Zero leakage (at water pressure)		
Proof pressure <sup>2)</sup>	0.38 MPa		
Ambient Temperature <sup>6)</sup>	0 to 50°C		
Fluid Temperature <sup>6)</sup>	0 to 50°C (No Freezing)		
Valve chamber volume <sup>3)</sup>	20 µL		
Mounting orientation <sup>4)</sup>	Free		
Enclosure	IP40 or equivalent		
Weight	34 g		
Rated Voltage	12, 24 VDC		
Voltage fluctuation <sup>7)</sup>	±10% of rated voltage		
Type of coil insulation	Class B		
Power Consumption (When rated voltage is 24V)	Standard	1.5 W (0.06 A)	
	Power Saving	Inrush	2.5 W (0.1 A)
		Holding	1 W
Coil switching noise <sup>8)</sup>	50 dB		

Table 5

Model	Base mounted		
	LVM10R3	LVM10R4	LVM10R6
Valve construction	Direct operated rocker type		
Valve type	N.C.	N.O.	N.C.
Number of ports	2		
Fluid <sup>1)</sup>	Air, Water, DI water, Diluent, Cleaning fluid		
Operating pressure	-75 kPa to 0.25 MPa		
Orifice diameter	1.4 mm		
Response time <sup>5)</sup>	10 ms or less (air)		
Leakage	Zero leakage (at water pressure)		
Proof pressure <sup>2)</sup>	0.38 MPa		
Ambient Temperature <sup>6)</sup>	0 to 50°C		
Fluid Temperature <sup>6)</sup>	0 to 50°C (No Freezing)		
Valve chamber volume <sup>3)</sup>	20 µL		
Mounting orientation <sup>4)</sup>	Free		
Enclosure	IP40 or equivalent		
Weight	34 g (Without subplate) 42 g (With subplate)		
Rated Voltage	12, 24 VDC		
Voltage fluctuation <sup>7)</sup>	±10% of rated voltage		
Type of coil insulation	Class B		
Power Consumption (When rated voltage is 24V)	Standard	1.5 W (0.06A)	
	Power Saving	In-rush	2.5 W (0.1A)
		Hold-ing	1 W
Coil switching noise <sup>8)</sup>	50 dB		

Table 6

## 2 Specification - continued

Model	Body ported		Base mounted	
	LVM102R		LVM105R	
Valve construction	Direct operated rocker type			
Valve type	Universal			
Number of ports	3			
Fluid <sup>1)</sup>	Air, Water, DI water, Diluent, Cleaning fluid			
Operating pressure	-75 kPa to 0.25 MPa			
Orifice diameter	1.4 mm			
Response time <sup>5)</sup>	10 ms or less (air)			
Leakage	Zero leakage (at water pressure)			
Proof pressure <sup>2)</sup>	0.38 MPa			
Ambient Temperature <sup>6)</sup>	0 to 50°C			
Fluid Temperature <sup>6)</sup>	0 to 50°C (No Freezing)			
Valve chamber volume <sup>3)</sup>	20 µL			
Mounting orientation <sup>4)</sup>	Free			
Enclosure	IP40 or equivalent			
Weight	34 g	34 g (Without subplate)		42 g (With subplate)
Rated Voltage	12, 24 VDC			
Voltage fluctuation <sup>7)</sup>	±10% of rated voltage			
Type of coil insulation	Class B			
Power Consumption (When rated voltage is 24V)	Standard	1.5 W (0.06 A)		
		Power Saving	Inrush	2.5 W (0.1 A)
	Holding			1 W
		Coil switching noise <sup>8)</sup>		50 dB

Table 7

## 2.3 General Specifications LVM11/13

Model	Body ported		Base mounted		
	LVM11		LVM13		
Valve construction	Direct operated poppet type				
Valve type	N.C.				
Number of ports	2				
Fluid <sup>1)</sup>	Air, Water, DI water, Diluent, Cleaning fluid				
Operating pressure	0 to 0.25 MPa				
Orifice diameter	1.5 mm				
Response time <sup>5)</sup>	10 ms or less (air)				
Leakage	Zero leakage (at water pressure)				
Proof pressure <sup>2)</sup>	0.38 Mpa				
Ambient Temperature <sup>6)</sup>	0 to 50°C				
Fluid Temperature <sup>6)</sup>	0 to 50°C (No Freezing)				
Valve chamber volume <sup>3)</sup>	11 µL	13 µL			
Mounting orientation <sup>4)</sup>	Free				
Enclosure	IP40 or equivalent				
Weight	30 g				
Rated Voltage	12, 24 VDC				
Voltage fluctuation <sup>7)</sup>	±10% of rated voltage				
Type of coil insulation	Class B				
Power Consumption (When rated voltage is 24V)	Power saving	Inrush	2.5 W (0.1 A)		
			Holding	1 W	
	Coil switching noise <sup>8)</sup>			50 dB	

Table 8

## 2 Specification - continued

## 2.4 General Specifications LVM15/150

Model	Base mounted	
	LVM15R3	LVM15R4
Valve construction	Direct operated rocker type	
Valve type	N.C	N.O
Number of ports	2	
Fluid <sup>1)</sup>	Air, Water, DI water, Diluent, Cleaning fluid	
Operating pressure range	Standard	-75 kPa to 0.25 MPa
	High-pressure	Maximum 0.6 MPa <sup>*</sup>
Orifice diameter	Standard	1.6 mm
	High-pressure	1 mm
Response time <sup>5)</sup>	15 ms or less (air)	
Leakage	Zero leakage (at water pressure)	
Proof pressure <sup>2)</sup>	Standard	0.38 MPa
	High-pressure	0.9 MPa
Ambient Temperature <sup>6)</sup>	0 to 50°C	
Fluid Temperature <sup>6)</sup>	0 to 50°C (No Freezing)	
Valve chamber volume <sup>3)</sup>	50 µL	
Mounting orientation <sup>4)</sup>	Free	
Enclosure	IP40 or equivalent	
Weight	45 g (Without Subplate)	
	56 g (With subplate)	
Rated Voltage	12, 24 VDC	
Voltage fluctuation <sup>7)</sup>	±10% of rated voltage	
Type of coil insulation	Class B	
Power Consumption (When rated voltage is 24V)	Inrush	5.5 W (0.23 A)
		Holding
Coil switching noise <sup>8)</sup>	60 dB	

Table 9

\* The high-pressure type can also be used at -75 kPa. However, 0.6 MPa is the maximum pressure differential.

Model	Base mounted	
	LVM15R6	LVM155R
Valve construction	Direct operated rocker type	
Valve type	N.C	Universal
Number of ports	2	3
Fluid <sup>1)</sup>	Air, Water, DI water, Diluent, Cleaning fluid	
Operating pressure range	Standard	-75 kPa to 0.25 MPa
	High-pressure	Maximum 0.6 MPa <sup>*</sup>
Orifice diameter	Standard	1.6 mm
	High-pressure	1 mm
Response time <sup>7)</sup>	15 ms or less (air)	
Leakage	Zero leakage (at water pressure)	
Proof pressure <sup>2)</sup>	Standard	0.38 MPa
	High-pressure	0.9 MPa
Ambient Temperature <sup>6)</sup>	0 to 50°C	
Fluid Temperature <sup>6)</sup>	0 to 50°C (No Freezing)	
Valve chamber volume <sup>3)</sup>	60 µL	50 µL
Mounting orientation <sup>4)</sup>	Free	
Enclosure	IP40 or equivalent	
Weight	45 g (Without Subplate)	
	56 g (With subplate)	
Rated Voltage	12, 24 VDC	
Voltage fluctuation <sup>7)</sup>	±10% of rated voltage	
Type of coil insulation	Class B	
Power Consumption (When rated voltage is 24V)	Inrush	5.5 W (0.23 A)
		Holding
Coil switching noise <sup>8)</sup>	60 dB	

Table 10

\* The high-pressure type can also be used at -75 kPa. However, 0.6 MPa is the maximum pressure differential.

## 2 Specification - continued

## 2.5 General Specifications LVM20/200

Model	Body ported		
	LVM20R1	LVM20R2	LVM20R2R
Valve construction	Direct operated rocker type		
Valve type	N.C	N.O	Universal
Number of ports	2		3
Fluid <sup>1)</sup>	Air, Water, DI water, Diluent, Cleaning fluid		
Operating pressure range	-75 kPa to 0.25 MPa		
Orifice diameter	2 mm		
Response time <sup>5)</sup>	20 ms or less (air)		
Leakage	Zero leakage (at water pressure)		
Proof pressure <sup>2)</sup>	0.38 MPa		
Ambient Temperature <sup>6)</sup>	0 to 50°C		
Fluid Temperature <sup>6)</sup>	0 to 50°C (No Freezing)		
Valve chamber volume <sup>3)</sup>	84 µL		
Mounting orientation <sup>4)</sup>	Free		
Enclosure	IP40 or equivalent		
Weight	80g		
Rated voltage	12, 24 VDC		
Allowable voltage fluctuation <sup>7)</sup>	±10% of rated voltage		
Type of Coil insulation	Class B		
Power Consumption (When rated voltage is 24V)	Standard	2.5 W (0.1 A)	
		Power Saving	In-rush
	Hold-ing		0.6 W
Coil switching noise <sup>8)</sup>	60 dB		

Table 11

Model	Base mounted		
	LVM20R3	LVM20R4	LVM205R
Valve type	N.C	N.O	Universal
Number of ports	2		3
Fluid <sup>1)</sup>	Air, Water, DI water, Diluent, Cleaning fluid		
Operating pressure range	-75 kPa to 0.3 MPa		
Orifice diameter	2 mm		
Response time <sup>5)</sup>	20 ms or less (air)		
Leakage	Zero leakage (at water pressure)		
Proof pressure <sup>2)</sup>	0.45 MPa		
Ambient Temperature <sup>6)</sup>	0 to 50°C		
Fluid Temperature <sup>6)</sup>	0 to 50°C (No Freezing)		
Valve chamber volume <sup>3)</sup>	84 µL		
Mounting orientation <sup>4)</sup>	Free		
Enclosure	IP40 or equivalent		
Weight	80 g (Without subplate)		
	94 g (With subplate)		
Rated voltage	12, 24 VDC		
Allowable voltage fluctuation	±10% of rated voltage		
Type of coil insulation	Class B		
Power Consumption (When rated voltage is 24V)	Standard	2.5 W (0.1 A)	
		Power saving	In-rush
	Hold-ing		0.6 W
Coil switching noise <sup>8)</sup>	60 dB		

Table 12

## 2 Specification - continued

## Notes:

- Select an appropriate fluid contact material according to the fluid to be used. Additionally, check the chemical resistance beforehand.
- Indicates the pressure which does not generate breakage or cracks after a one-minute airtight test
- Indicates the volume inside the valve chamber after the volume of the diaphragm is subtracted.
- When residual liquid needs to be taken into consideration, mounting in a vertical direction with the coil at the top is recommended. When residual liquid need not be taken into consideration, any mounting orientation is available.
- In compliance with JIS B 8419:2010 (Value at ambient and fluid temperatures of 25°C, rated voltage, max. operating pressure (air), and when the N.C. (IN) port is pressurized) The response time will vary depending on the supply pressure, fluid, piping conditions, and ambient temperature.
- When the diaphragm material is Kalrez®, the valve response time will be significantly longer at ambient and fluid temperatures of 15°C or less when compared to the valve response time at room temperature (≈ 25°C).
- When response time is prioritized, control the voltage so that there is no fluctuation below the rated voltage.
- The value is based on SMC's measurement conditions. The noise level will vary according to the actual conditions.

## 2.6 Flow characteristics

Model	Flow Characteristics			
	Water		Air	
	Kv	Cv	C	b
LVM07	0.004	0.005	0.02	0.2
LVM09	0.015	0.018	0.06	0.2
LVM10	0.025	0.03	0.1	0.2
LVM11/13	0.034	0.04	0.13	0.22
LVM15 <sup>*</sup>	0.034 [0.012]	0.04 [0.015]	0.13 [0.05]	0.22 [0.2]
LVM20	0.055	0.065	0.23	0.27

\* The [ ] indicates the values of the high-pressure type.

## Warning

Special products might have specifications different from those shown in this section. Contact SMC for specific drawings.

## 3 Installation

## 3.1 Installation

## Warning

- Do not install the product unless the safety instructions have been read and understood.

## 3.1.1 LVM07 Mounting interface

## Recommended interface dimensions (mm)

When using a positioning pin for mounting please use Ø 1.5 mm and a height 2 mm or less  
For option P, the size should be Ø1.5 mm and the depth should be 2.3 mm or more

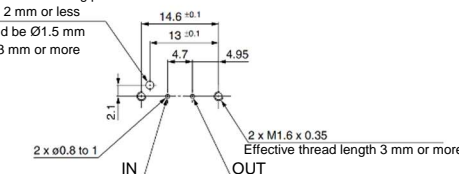

Figure 2

**3 Installation - continued**

**3.1.2 LVM09/090 Mounting interface**

**Recommended interface dimensions (mm)**

\* Surface roughness = Rz3.2 or less

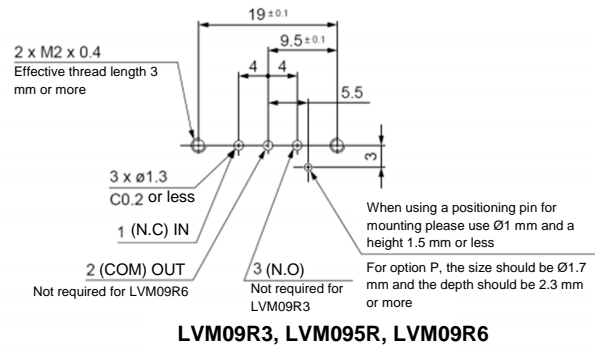

**LVM09R3, LVM095R, LVM09R6**

\* Surface roughness = Rz3.2 or less

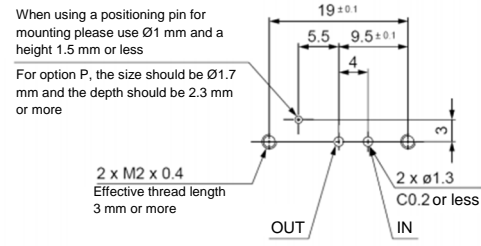

**LVM09R4**

Figure 3

**3.1.3 LVM10/100 Mounting interface**

**Recommended interface dimensions (mm)**

Surface roughness = Rz3.2 or less

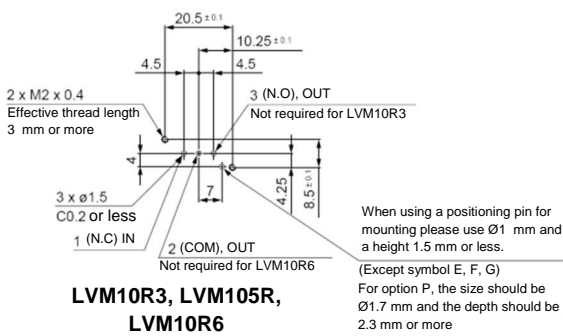

**LVM10R3, LVM105R, LVM10R6**

\* Surface roughness = Rz3.2 or less

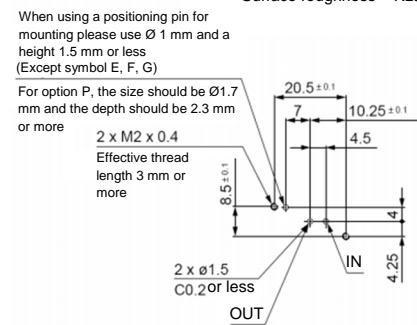

**LVM10R4**

Figure 4

**3 Installation - continued**

**3.1.4 LVM15/150 Mounting interface**

**Recommended interface dimensions (mm)**

\* Surface roughness = Rz3.2 or less

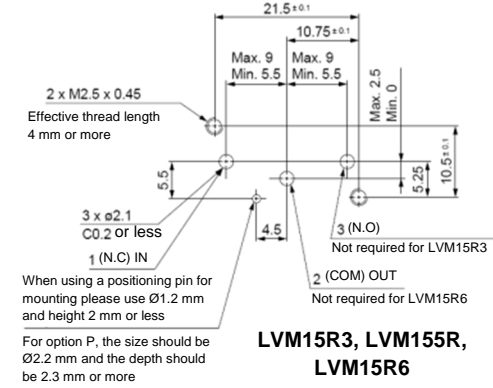

**LVM15R3, LVM155R, LVM15R6**

\* Surface roughness = Rz3.2 or less

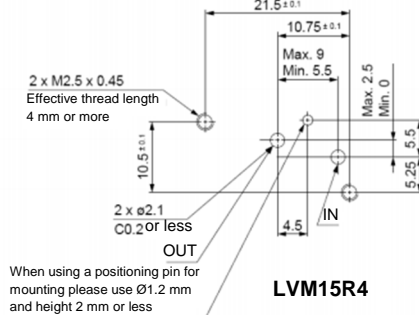

**LVM15R4**

Figure 5

**3.1.5 LVM20/200 Mounting interface**

**Recommended interface dimensions (mm)**

\* Surface roughness = Rz3.2 or less

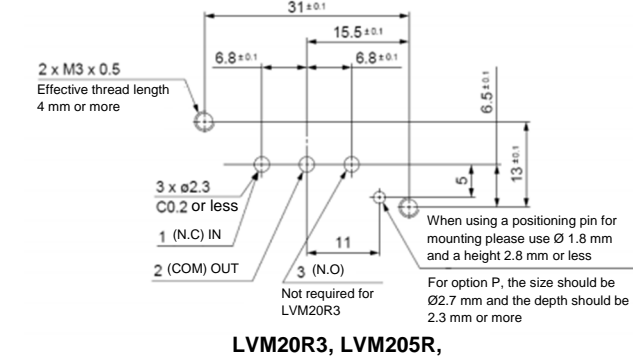

**LVM20R3, LVM205R,**

\* Surface roughness = Rz3.2 or less

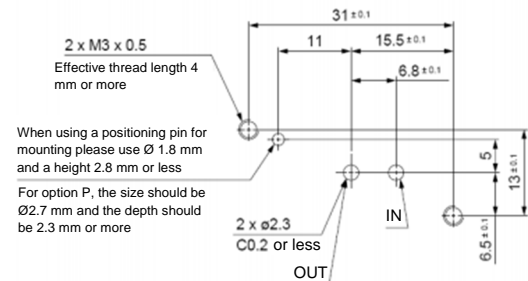

**LVM20R4**

Figure 6

**3 Installation - continued**

**3.1.6 LVM13 Mounting interface**

**Recommended interface dimensions (mm)**

\* Surface roughness = Rz3.2 or less

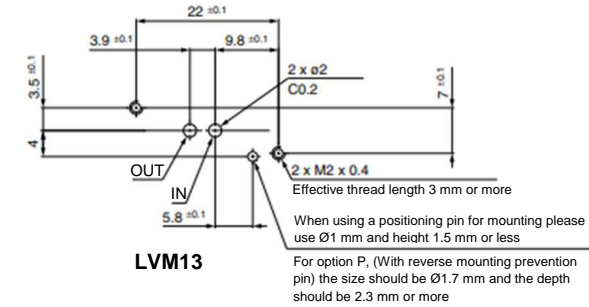

**LVM13**

Figure 7

**3.2 Environment**

**Warning**

- Do not use in an environment where corrosive gases, chemicals, salt water or steam are present.
- Do not use in an explosive atmosphere.
- Do not expose to direct sunlight. Use a suitable protective cover.
- Do not mount in a location exposed to radiant heat that would result in temperatures in excess of the product's specifications.
- **Do not install in a location subject to excessive vibration or impact.**

Impact resistance of the solenoid valve is 150 m/s<sup>2</sup>. Vibration resistance of this solenoid is 30 m/s<sup>2</sup>

**3.3 Piping**

**Caution**

- When installing piping or fittings, ensure sealant material does not enter inside the port. When using seal tape, leave 1 thread exposed on the end of the pipe/fitting.

**Preparation before piping**

Before piping is connected, it should be thoroughly blown out with air (flushing) or washed to remove chips, cutting oil, and other debris from inside the pipe.

- **When tubing is connected to the body-ported solenoid valve, insert the tubing straight to the end of the tube inlet for a complete fit.**

Model	Tube inside diameter (I.D.)	Tube outside diameter (O.D.) (after mounting)
LVM09R1, 09R2, 092R	Ø1.9 or less	Ø4.2 or less
LVM10R1, 10R2, 102R	Ø2.5 or less	Ø4.5 or less
LVM20R1, 20R2, 202R	Ø3.1 or less	Ø6.8 or less

Table 13

The holding force varies by the tubing material. Be sure to confirm the holding force of each material before operation. After connecting the tubing, care should be taken not to put excessive force (tensile force, compression, bending, etc.) on the tubing. If an external force of 20 N or more is applied to the tube inlet, the inlet may become damaged, and leakage or breakage could occur.

- **When the tubing is long or depending on the operating conditions, tubing may thrash about causing damage to the tube inlet of the solenoid valve, or the tubing to come off or deteriorate.**

In this case, secure the tubing to prevent its uncontrolled movement.

- **When piping the fitting to the solenoid valve, the installation method and tightening torque value may vary depending on the seal structure (shape) or material of the fitting to be used. Check the methods and precautions recommended by the fitting manufacturer to be used and be sure to check for leakage.**

**3 Installation - continued**

The table below shows the tightening method using KQ2 series

Model	Location	Thread size	Tightening method	Tightening torque [N.m]
LVM11	Body	M5	After tightening by hand, tighten 1/6 to 1/4 turn with a tightening tool.	PEEK: 0.5 to 0.7
LVM10R3, 10R4, 10R6, 105R	Base mounted (With subplate)	M6 or 1/4-28UNF	After tightening by hand, tighten 1/6 to 1/4 turn with a tightening tool.	PVDF: 0.6 to 0.8 PFA: 0.2 to 0.25
LVM15R3, 15R4, 15R6, 155R		M6 or 1/4-28UNF	After tightening by hand, tighten 1/6 to 1/4 turn with a tightening tool.	PVDF: 0.6 to 0.8
LVM20R3, 20R4, 205R		Rc1/8 or NPT1/8	Tighten approximately 4 turns.	PVDF: 0.5 to 0.6
		G1/8	After tightening by hand, tighten 1/3 to 1/2 turn with a tightening tool.	PVDF: 0.4 to 0.6

Table 14

**3.4 Mounting**

**Caution**

- **Always tighten threads with the proper tightening torque.** When mounting the solenoid valve, tighten it with the proper tightening torque shown below.

Location	Model	Thread size	Tightening Torque [N.m]
Base Mounting,	LVM07R6	M1.6	0.06 to 0.1
	LVM09R3, 09R4, 09R6, 095R	M2	0.1 to 0.14
	LVM13	M2	0.15 to 0.2
Body Mounting	LVM10R3, 10R4, 10R6, 105R	M2	0.15 to 0.2
	LVM15R3, 15R4, 15R6, 155R	M2.5	0.25 to 0.35
	LVM20R3, 20R4, 205R	M3	0.4 to 0.6

Table 15

- Mount the solenoid valve on the horizontal surface.
- Remove dust from the solenoid valve mounting surface completely. The surface roughness of the mounting surface should be Rz3.2 or less.
- When mounting the solenoid valves next to each other, the valve pitch should be the value or more shown in the table below.

Model	LVM07	LVM09/090	LVM13	LVM10/100	LVM15/150	LVM20/200
Pitch	8	10.5	14	14	17	21

Table 16

**Warning**

- If air leakage increases or equipment does not operate properly, stop operation. After mounting, perform suitable function and leak tests to confirm that the mounting is correct.
- Since the body (orifice shape) is designed to eliminate residual liquid, mounting in a vertical direction with the coil at the top is recommended. When residual liquid need not be taken into consideration, any mounting orientation is available.



### 3 Installation - continued

#### 3.5 Electrical Connection

##### Caution

- Valves with power-saving circuits, LVM####(Y/Y1/HY), have polarity. Ensure correct electrical connections are made, see Figure 8.

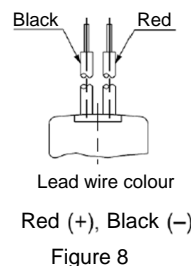

- Avoid mis-wiring, as this can cause malfunction, damage and fire to the product.
- To prevent noise and surge in signal lines, keep all wiring separate from power lines and high voltage lines. Otherwise this can cause malfunction.
- When a surge from the solenoid affects the electrical circuitry, install a surge absorber, etc., in parallel with the solenoid. Or, adopt an option that comes with the surge voltage protection circuit.
- Use electrical circuits that do not generate chattering in their contacts.
- Use voltage that is within  $\pm 10\%$  of the rated voltage. In cases with a DC power supply where responsiveness is important, control the voltage so that there is no fluctuation below the rated voltage.
- Generally use electrical wire with cross sectional area 0.5 to 1.25 mm<sup>2</sup>.
- Do not bend or pull cables repeatedly.
- Connect the wires so that an external force greater than 10 N is not applied to the lead wire, otherwise the coil will burn.

#### 3.6 How to use plug connectors

##### Caution

##### Attaching Connectors

Hold the lever and connector unit between your fingers and insert straight onto the pins of the solenoid valve so that the lever's pawl is pushed into the groove and locks.

##### Detaching connectors

Remove the pawl from the groove by pushing the lever downward with your thumb and pull the connector straight out.

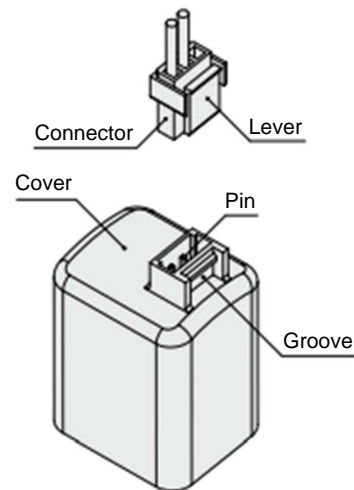

Figure 9

### 3 Installation - continued

#### 3.7 Valves with a power saving circuit (PWM built-in type)

##### Caution

- Valves with a power saving circuit (PWM circuit built-in type) perform the high-speed switching operation with the PWM control circuit inside the valve after the rated power has been applied for several tens of ms to reduce the power consumption.

The problems shown below may occur in this type of valve due to the switch or drive circuit system used for the PWM control. Be sure to check the operation with the customer's machine sufficiently when selecting the product.

- If Valve does not turn ON
  - If the PWM circuit built-in type valve is driven by a mechanical relay, etc., and chattering occurs during the several tens of ms necessary for the valve to reach its rated voltage, the valve may not turn ON correctly.
  - If a filter, etc., is connected between the power supply and the PWM circuit built-in type valve, the current necessary to drive the valve lowers due to the effects of the filter, and then the valve may not turn ON correctly.
- If Valve does not turn OFF
  - If the PWM circuit built-in type valve is driven by the photo coupler, the photo coupler cannot turn OFF and the valve is kept in an ON state. Therefore, take great care when using the photo coupler built-in SSR (solid state relay) or drive circuit.

### 4 Settings

#### 4.1 Manual Override

##### Caution

- Ensure conditions are safe, since connected equipment will operate when manual override is performed.

##### Non-locking push type

- Push on the manual override button using a small-bladed screwdriver or a suitable tool until it stops ON.
- Hold this position for the duration of the check (ON position)
- Release the button and the override will re-set to OFF position.

##### LVM10/100 Manual override position

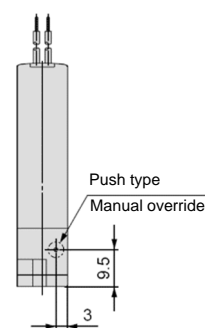

Figure 10

### 5 How to Order

Refer to *drawings or catalogue* for 'How to Order'.

### 6 Outline Dimensions (mm)

Refer to *drawings or catalogue* for outline dimensions.

### 7 Maintenance

#### 7.1 General Maintenance

##### Caution

- Not following proper maintenance procedures could cause the product to malfunction and lead to equipment damage.
- If handled improperly, compressed air can be dangerous.
- Maintenance of pneumatic systems should be performed only by qualified personnel.
- Before performing maintenance, turn off the power supply and be sure to cut off the supply pressure. Confirm that the air is released to atmosphere.
- After installation and maintenance, apply operating pressure and power to the equipment and perform appropriate functional and leakage tests to make sure the equipment is installed correctly.
- If any electrical connections are disturbed during maintenance, ensure they are reconnected correctly and safety checks are carried out as required to ensure continued compliance with applicable national regulations.
- Do not make any modification to the product.
- Do not disassemble the product, unless required by installation or maintenance instructions.
- Before operating remove residual chemicals and completely replace with pure water, air etc.
- The installation should allow sufficient space for maintenance activities.

### 8 Limitations of Use

#### 8.1 Limited warranty and Disclaimer/Compliance Requirements

Refer to Handling Precautions for SMC Products.

##### Warning

##### Fluid properties

- Be sure to confirm the compatibility between the component material and fluid.
- Liquid (Chemicals)**  
Chemical fluids could crystallize or clot depending on its nature. Leakage will occur if a crystallized or clotted fluid is caught between

the sealing parts. Take measures to clean such component if necessary.

- Water  
Install a filter strainer of about 100 mesh on the inlet side of the piping.
- Air  
Compressed air filtered with a filter with filtration rating of 5  $\mu\text{m}$  or less, which is mounted on the inlet side of the piping, should be used.

##### Confirm the specifications

Do not exceed any of the specifications in section 2 of this document or the specific product catalogue.

##### Fluid pressure range

Fluid pressure should be within the allowable pressure range.

##### Ambient environment

Use within the allowable ambient temperature range. Ensure the fluid does not touch the external surface of the product.

##### Low temperature environments

When valve's diaphragm material is Kalrez® be aware that the valve changeover time becomes extremely long when the ambient and fluid temperature becomes 15°C or less as a reference when compared to the valve changeover time at room temperature (approx. 25°C).

##### Countermeasures against static electricity

Take measures to prevent static electricity since some fluids can cause static electricity

##### Pressure (including vacuum) holding

This product is not suitable for an application such as holding the pressure (including vacuum) inside a pressure vessel, because the valve has allowable leakage.

### 8 Limitations of Use - continued

- Cannot be used as an emergency shut-off valve etc.

This product is not designed for safety applications such as an emergency shut-off valve. If the valves are used in this type of system, other reliable safety assurance measures should also be adopted.

##### Extended periods of continuous energization

If solenoid valves are to be continuously energized for extended periods of time, use valves with power-saving circuit to minimise the amount of heat radiated by the coil.

Power-saving circuit waveform (Shown in Figure 11)

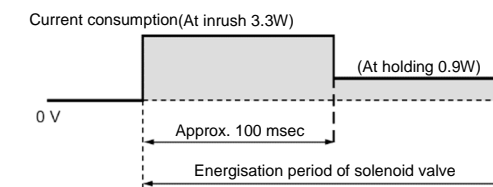

Figure 11

When a solenoid valve without a power-saving circuit is continuously energized for long periods of time its life and performance can deteriorate due to heat generated by the coil. The heat generated can also affect sensitive devices nearby. If continuous energisation is necessary, install a fan or take other measures to ensure valve surface temperature is kept below 70°C.

Table 17 shows reference values for continuously energized valve.

Series	LVM09/090	LVM10/100	LVM20/200
Period of continuous energisation	5 min. or less	30 min. or less	30 min. or less
Duty ratio	50% or less		
Ambient temperature	25°C or less		
Power-saving circuit	None		

Table 17

Duty ratio: ON time/(ON time + OFF time).

For the LVM15/150, power-saving circuit is standard.

Please use a fan or take other measures to disperse heat and keep

temperatures within the specified range when mounting the solenoid valves inside control panels.

Be especially careful when using three or more adjacent valves with manifolds and keeping them continuously energized for extended periods, as this may result in dramatic increases in temperature.

### 9 Product disposal

This product should not be disposed of as municipal waste. Check your local regulations and guidelines to dispose this product correctly, in order to reduce the impact on human health and the environment.

### 10 Contacts

Refer to [www.smcworld.com](http://www.smcworld.com) or [www.smc.eu](http://www.smc.eu) for contacts.

## SMC Corporation

URL : <http://www.smcworld.com> (Global) <http://www.smc.eu> (Europe)  
 'SMC Corporation, Akihabara UDX15F, 4-14-1, Sotokanda, Chiyoda-ku, Tokyo 101 0021  
 Specifications are subject to change without prior notice from the manufacturer.  
 © 2020 SMC Corporation All Rights Reserved.  
 Template DKP50047-F-085J