

Large Size Vacuum Module:

ZR Series

Ejector System/Vacuum Pump System



- Large suction flow rate, suitable when used with large size pads or multiple pads.
- Nozzle dia. $\varnothing 1.0$, $\varnothing 1.3$, $\varnothing 1.5$, $\varnothing 1.8$, $\varnothing 2.0$
- Vacuum module suitable for handling workpieces of 0.5 to 5 kg.

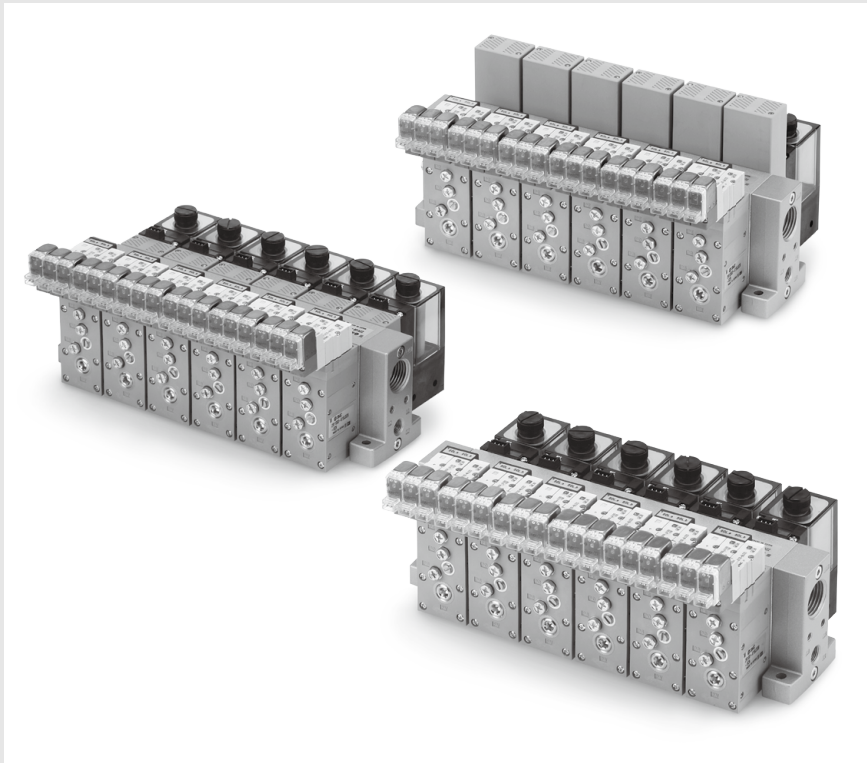

ZR Series

Vacuum module suitable for handling workpieces of 0.5 to 5 kg.

- **Modular design/Customized application function through selection of modular components.**
- **Modules for use with external vacuum supply (from pump or mainline) or as an air driven ejector system.**
- **Safe — Vacuum self-holding function by means of double solenoid valves.**
- **Compact, Lightweight**
- **Manifolding possible**

Vacuum ejector type complete unit

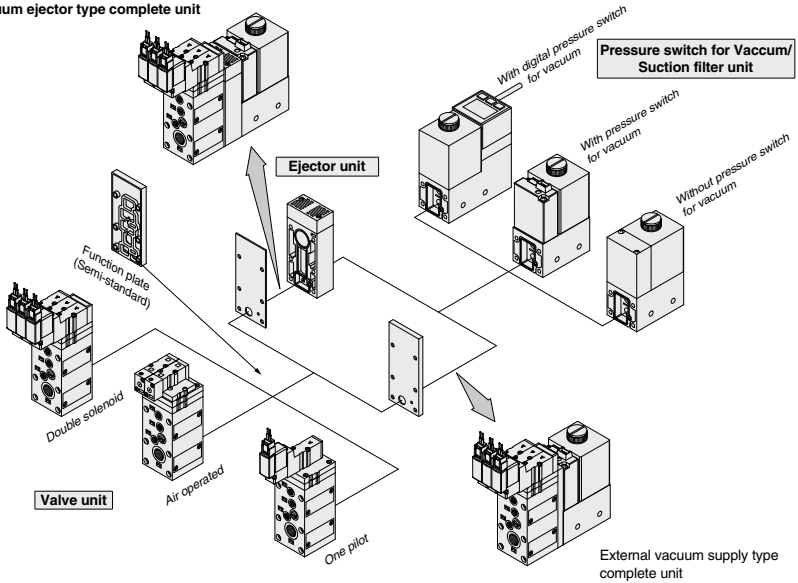



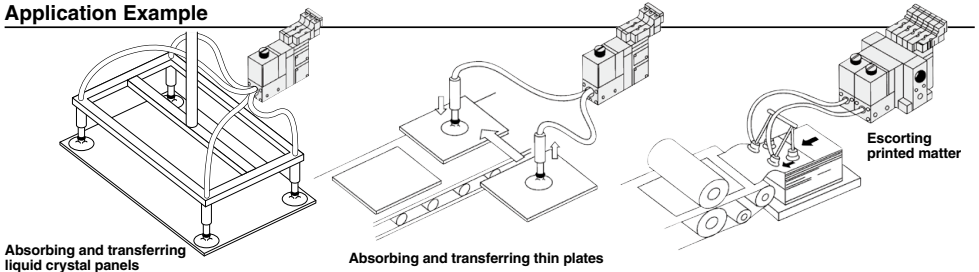

Application Example



Absorbing and transferring copper plates, Automatic labeling machine, Absorbing and transferring veneers, Automatic screw fastening machine

Modular Components Introduction

System		Ejector System	Vacuum Pump System	
		P. 634 to 663	P. 664 to 679	
Component equipment	Characteristics			
Ejector unit ZR1-W 	Nozzle dia. (mm)	1.0 1.3 1.5 1.8 2.0		
	Maximum suction flow rate (L/min. [ANRI])	Type S		25 42 63 74 95
		Type L		44 55 88 105 132
	Air consumption (L/min [ANRI])			53 86 102 155 194
	Maximum vacuum pressure	S: -84 kPa L: -53 kPa		
Exhaust release (Ejector exhaust)	Built-in silencer, Manifold exhaust Individual exhaust port			
Valve unit ZR1-V 	Component equipment	Supply valve (Pilot type)/Release valve (Pilot type)		
	Function	Double SOL, N.C., N.O.		
	Operation	Solenoid valve (Double, Single)/Air operated valve		
	Power supply voltage	3, 5, 6, 12, 24 VDC, 100, 110 VAC (50/60Hz)		
Pressure switch for vacuum ZSE2-0R-15/55 ZSE30A-00-□-□□□ 	Rated pressure range/Set pressure range	0 to -101 kPa		
	Hysteresis	3% or less/variable		
	Operating voltage	12 to 24 VDC (Ripple ±10% or less)		
Suction filter unit ZR1-F 	Operating pressure range	-0.1 to 0.5MPa		
	Filtration degree	30 μ m		
	Material	PVA sponge		
Function plate ZR1-RV 	Symbol	RV1	Air pressure supply (PV) port → Pilot pressure supply (PS) port → Release pressure supply (PD) port	
		RV2	Air pressure supply (PV) port → Pilot pressure supply (PS) port / Release pressure supply (PD) port	
		RV3	Air pressure supply (PV) port / Pilot pressure supply (PS) port → Release pressure supply (PD) port	
Common specifications	Unit Manifold	Air supply port	Rc 1/8	
		Vacuum pad connection port	Rc 1/8	
		Air supply port	1/8 (Rc, NPTF, G)	
		Pilot valve connection port	M5	
		Release valve connection port	M5	
		Common exhaust port	1/2 (Rc, NPTF, G)	
External vacuum supply port	—	Rc 1/8		
Refer to pages 640 to 650 for further specifications of each unit.				

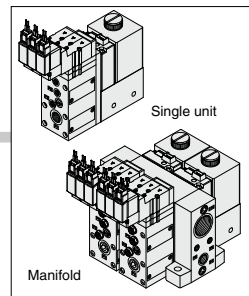
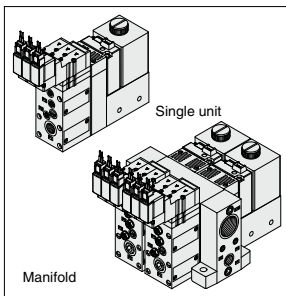

Large Size Vacuum Module: Ejector System



[Option]
Note) CE/UKCA-compliant:
For DC only.

ZR Series

Ejector + With Valve

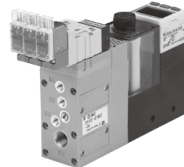

How to Order

Note for model selection

Take function plates into consideration. (Refer to page 637.)

Components

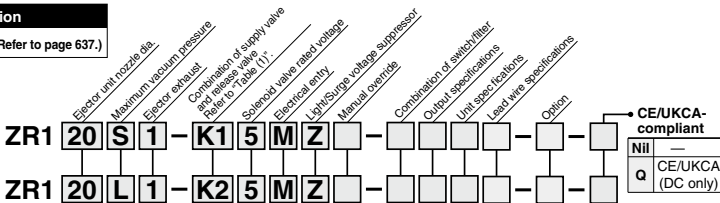
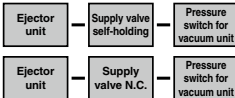

Ejector module nozzle diameter

10	1.0	18	1.8
13	1.3	20	2.0
15	1.5		

Maximum vacuum pressure

S	-84 kPa
L	-53 kPa

Ejector exhaust

Symbol	Type	Valve	Manifold
1	Built-in silencer	●	●
2 <small>Note 1)</small>	Port exhaust	●	●
3 <small>Note 2)</small>	Common exhaust	—	●

Combination of supply valve and release valve
 Refer to "Table (1)" on page 635 for details.

Note 1) When port exhaust is applied to the manifold, pilot exhaust is done by common exhaust. Thus, the exhaust port on the manifold base should be open while operating.

Note 2) When the product is used for the manifold specification and common exhaust, the exhaust air of the operating ejector releases may enter the vacuum (V) port of the non-operating ejector and be released if there are an operating and non-operating ejector. Select either the built-in silencer or port exhaust for the ejector exhaust method.

Solenoid valve rated voltage

Nil <small>Note)</small>	Air operated	CE/UKCA-compliant
5	24 VDC	—
6	12 VDC	●
V	6 VDC	●
S	5 VDC	●
R	3 VDC	●
D1 <small>Note)</small>	100 VAC (50/60 Hz)	—
D2 <small>Note)</small>	110 VAC (50/60 Hz)	—

Note) Air operated, 100 VAC, and 110 VAC type are not CE/UKCA-compliant.

Electrical entry

Nil	Air operated
L	L plug connector
LN	Lead wire length 0.3 m
LO	Without lead wire
M	M plug connector
MN	Without lead wire
MO	Without connector
G	Grommet
H	type

• Refer to "Table (2)" on page 635 for part no. of lead wire with connector.

Light/Surge voltage suppressor

Nil	None
Z	With light/surge voltage suppressor
S	With surge voltage suppressor

* S is not available for AC.
 DC voltage (with surge voltage suppressor)
 If the polarity is incorrect at DC (surge voltage suppressor), diode or switching element may be damaged.

Manual override

Nil	Non-locking push type
B	Slotted locking type

Combination of switch/filter

Nil <small>Note)</small>	None
D	Digital pressure switch for vacuum (ZSE30A) + Filter
E	Pressure switch for vacuum (ZSE2) + Filter
F	Filter

Note) Cannot be selected for the type without a supply or release valve

Output specifications

Digital pressure switch for vacuum (ZSE30A) specifications (D)	Pressure switch for vacuum (ZSE2) specifications (E)
N	NPN open collector 1 output
P	PNP open collector 1 output
A	NPN open collector 2 outputs
B	PNP open collector 2 outputs
C	NPN open collector 1 output + Analog voltage output
D	NPN open collector 1 output + Analog current output
E	PNP open collector 1 output + Analog voltage output
F	PNP open collector 1 output + Analog current output

Option/Shipped separately

	Release flow adjusting needle with lock nut	Bracket (Included)
Nil	None	●
L	●	None
M	●	None
N	None	None

Shipped with the manifold assembly

Nil	Release flow adjusting needle with lock nut
Nil	None
L	●

Note) Brackets are not shipped together with the manifold assembly.

Lead wire specifications

Digital pressure switch for vacuum (ZSE30A) specifications (D)

Nil	Without lead wire
L	Lead wire with connector (Length 2 m)

Refer to Table (4)* on page 635 for part no. of lead wire with connector.

Pressure switch for vacuum (ZSE2) specifications (E)

Nil	Grommet/Lead wire (Length 0.6 m)
L	Grommet/Lead wire (Length 3 m)
C	Lead wire with connector (Length 0.6 m)
CL	Lead wire with connector (Length 3 m)
CN	Without lead wire with connector

Refer to Table (3)* on page 635 for part no. of lead wire with connector.

Filter specifications (F)

Nil	No setting
-----	------------

Unit specifications

Digital pressure switch for vacuum (ZSE30A) specifications (D)

Nil	With unit switching function
M	SI unit only
P	With unit switching function (Initial value psi)

Note 1) This is no longer sold for use in Japan due to the Weight and Measure Act (implemented October, 1999).
 Note 2) Fixed unit: kPa

Pressure switch for vacuum (ZSE2) specifications (E)

Nil	No setting
-----	------------

Filter specifications (F)

Nil	No setting
-----	------------

Large Size Vacuum Module: Ejector System

ZR Series

Ejector + Without Valve



[Option]
Note) Only the type with a pressure switch has CE marking.



How to Order

Components

Ejector unit — Pressure switch for vacuum unit → ZR1 20 S 1 — D

Ejector unit — Filter unit → ZR1 20 L 1 — D

Ejector module nozzle diameter

10	1.0	18	1.8
13	1.3	20	2.0
15	1.5		

Maximum vacuum pressure

S	-84 kPa
L	-53 kPa

Ejector exhaust

Symbol	Type	Valve	Manifold
1	Built-in silencer	●	●
2 ^{No=1}	Port exhaust	●	●
3 ^{No=2}	Common exhaust	—	●

Combination of switch/filter

D	Digital pressure switch for vacuum (ZSE30A) + Filter
E	Pressure switch for vacuum (ZSE2) + Filter
F	Filter

Option

CE-compliant	Nil	—
	Q	CE (DC only)

Option/Shipped separately

Bracket (Included)	Nil	None
	N	●

Note) Brackets are not shipped together with the manifold assembly.

Lead wire specifications

Digital pressure switch for vacuum (ZSE30A) specifications (D)

Nil	Without lead wire
L	Lead wire with connector (Length 2 m)

Refer to "Table (4)" on page 635 for part no. of lead wire with connector.

Pressure switch for vacuum (ZSE2) specifications (E)

Nil	Grommet/Lead wire (Length 0.6 m)
L	Grommet/Lead wire (Length 3 m)
C	Lead wire with connector (Length 0.6 m)
CL	Lead wire with connector (Length 3 m)
CN	Without lead wire with connector

Refer to "Table (3)" on page 635 for part no. of lead wire with connector.

Filter specifications (F)

Nil	No setting
-----	------------

Unit specifications

Digital pressure switch for vacuum (ZSE30A) specifications (D)

Nil	With unit switching function
M	SI unit only
P	With unit switching function (Initial value psi)

Note 1) This is no longer sold for use in Japan due to the Weight and Measure Act (implemented October, 1999).
Note 2) Fixed unit: kPa

Pressure switch for vacuum (ZSE2) specifications (E)

Nil	No setting
-----	------------

Filter specifications (F)

Nil	No setting
-----	------------

Output specifications

Digital pressure switch for vacuum (ZSE30A) specifications (D)

N	NPN open collector 1 output
P	PNP open collector 1 output
A	NPN open collector 2 outputs
B	PNP open collector 2 outputs
C	NPN open collector 1 output + Analog voltage output
D	NPN open collector 1 output + Analog current output
E	PNP open collector 1 output + Analog voltage output
F	PNP open collector 1 output + Analog current output

Pressure switch for vacuum (ZSE2) specifications (E)

Nil	NPN open collector 1 output
55	PNP open collector 1 output

Filter specifications (F)

Nil	No setting
-----	------------

Table (1) Combination of Supply Valve and Release Valve

Valve unit function			Valve unit components		Symbol	Supply valve			Release valve	
Operation stop	Vacuum adsorption	Vacuum release	Supply valve	Release valve		Solenoid valve		Air operated	Solenoid valve	Air operated
						Double SOL. (SYJ3233-X126)	N.C. (SYJ3133)	(SYJA3130)	N.C. (SYJ3133)	(SYJA3130)
☉	☉	○	Double SOL. (SYJ3233-X126)	N.C. (SYJ3133)	K1	●	—	—	●	—
○	○	○	N.C. (SYJ3133)	N.C. (SYJ3133)	K2	—	●	—	●	—
○	○	○	Air operated (SYJA3130)	Air operated (SYJA3130)	K3	—	—	●	—	●
×	○	○	N.C. (SYJ3133)		C1	—	●	—	(Common with supply valve)	—
×	○	○	Air operated (SYJA3130)		C2	—	—	●	—	(Common with supply valve)
×	○	○	N.O. (SYJ3133)		C3	—	●	—	(Common with supply valve)	—
<small>○: Possible; ☉: Possible with limitations (without self-locking function); ×: Not possible</small>					NI1	Without valve module				

Table (2) How to Order Valve Plug Connector Assembly

DC	SY100 - 30 - 4A	□
For 100 VAC	SY100 - 30 - 1A	□
For 110 VAC	SY100 - 30 - 3A	□

Lead wire length ↓

Lead wire length	mm
Nil	300 mm (Standard)
6	600 mm
10	1000 mm
15	1500 mm
20	2000 mm
25	2500 mm
30	3000 mm
50	5000 mm

How to order

When requiring a vacuum unit equipped with valves with lead wires of 600 mm or more, specify the vacuum module valves without the standard connectors and order the required connector ass'ys separately.

Example) ZR120S1-K15MOZ-EC(-Q) 1 pc.
* SY100-30-4A-6 3 pcs.

Table (3) Pressure Switch for Vacuum/Lead Wire with Connector

ZS - 10 - 5A	□
---------------------	---

Lead wire length ↓

Lead wire length	mm
Nil	0.6 m
30	3 m
50	5 m

How to order

When requiring a vacuum switch with a lead wire of 5 m, indicate the part numbers of the vacuum unit switch without a lead wire connector and the 5 m lead wire connector separately.

Example) ZR1□□□-□□□□□-□CN(-Q) 1 pc.
* ZS-10-5A-50 1 pc.

Table (4) Digital Pressure Switch for Vacuum/Lead Wire with Connector

ZS - 38 - 3 L	□
----------------------	---

Lead wire core ↓

Lead wire core	Specifications
3	3 cores, 1 output, 2 m (Output specifications: N, P)
4	4 cores, 2 outputs, 2 m (Output specifications: A, B, C, D, E, F)

Ejector System/Combination of Supply Valve and Release Valve

Combination Symbol: K1

Feature: Double solenoid supply valve allows for self-holding.

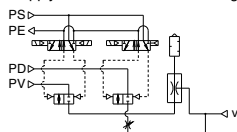

How to Operate

Operation	Pilot valve operation		Note
	Supply valve for supply	Release valve for release	
1. Adsorption	ON	OFF	When power supply is cut off while the supply valve is ON, the operational state is held.
2. Vacuum release	OFF	ON	
3. Operation stop	OFF	OFF	

Combination Symbol: K2

Feature: Single solenoid valve is provided for supply valve.

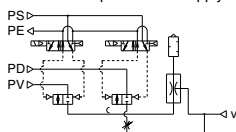

How to Operate

Operation	Pilot valve operation		Note
	Supply valve for supply	Release valve for release	
1. Adsorption	ON	OFF	When power supply is stopped, all operations will be stopped.
2. Vacuum release	OFF	ON	
3. Operation stop	OFF	OFF	

Combination Symbol: K3

Feature: Operation can be controlled by an external pilot valve.

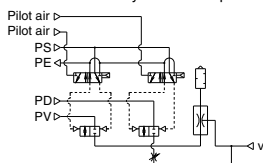

How to Operate

Operation	Pilot valve operation		Note
	Air operated a	Air operated b	
1. Adsorption	ON	OFF	The product is used under the environment in which solenoid valves cannot be used or when the centralized control is applied using external pilot air.
2. Vacuum release	OFF	ON	
3. Operation stop	OFF	OFF	

⚠ Caution

When pipe connection is made to one port connection (PV) port only, use a function plate (ZR1-RV1). Refer to page 637 for further information.

Combination Symbol: C1

Feature: Adsorption of workpieces (when energized) and release of vacuum (when de-energized) are switched by single solenoid valve.

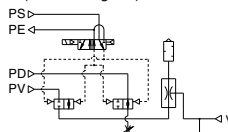

How to Operate

Operation	Pilot valve operation		Note
	Supply valve/Release valve	Pilot valve for supply/release	
1. Adsorption	ON	ON	Be careful for blowing off of workpieces or displacement of adsorption position in case of small and/or lightweight workpieces.
2. Vacuum release	OFF	OFF	

Combination Symbol: C2

Feature: Adsorption of workpieces and release of vacuum are switched by external pilot valve.

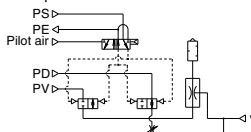

How to Operate

Operation	Pilot valve operation		Note
	Supply valve/Release valve	Air operated a	
1. Adsorption	ON	ON	Be careful for blowing off of workpieces or displacement of adsorption position in case of small and/or lightweight workpieces.
2. Vacuum release	OFF	OFF	

Combination Symbol: C3

Feature: Adsorption of workpieces (when de-energized) and release of vacuum (when energized) are switched by single solenoid valve.

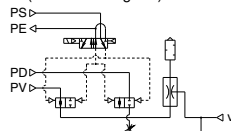

How to Operate

Operation	Pilot valve operation		Note
	Supply valve/Release valve	Pilot valve for supply/release	
1. Adsorption	OFF	OFF	Be careful for blowing off of workpieces or displacement of adsorption position in case of small and/or lightweight workpieces.
2. Vacuum release	ON	ON	

Function Plate/ZR1-RV□

A function plate is used when each connecting port for the valve unit is common. If a function plate is not used (standard), make individual pipe connections to PV, PS, and PD ports respectively.

Without Function Plate (Standard)

Applicable system: Ejector system
External vacuum supply system

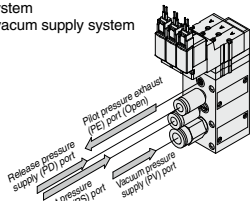

Pipe connection

Circuit diagram

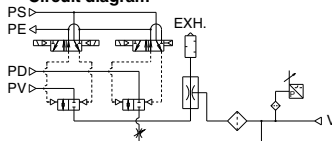

With Function Plate/Applicable to Ejector System Only

When ZR1/RV1 (PV PS PD) is Selected

Since PV, PS and PD ports are made common via the function plate, pipe only to the PV port.

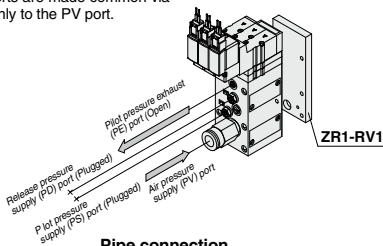

Pipe connection

Circuit diagram

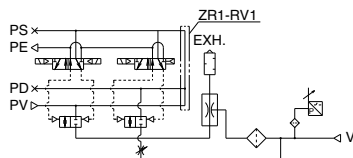

When ZR1/RV2 (PV PS/PD) is Selected

Supply air for generating vacuum and releasing vacuum respectively.

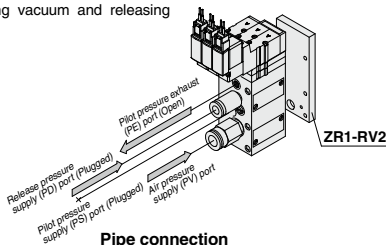

Pipe connection

Circuit diagram

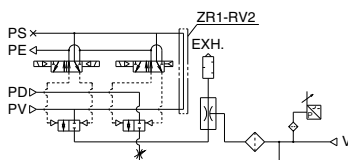

How to Order Function Plate Unit (For Ejector System)

ZR1 - RV 1

Piping specifications

Symbol	Indication	PV port	PS port	PD port
1	PV PS PD	Common		
2	PV PS/PD	Common	Individual	

How to order

Indicate the model numbers of the vacuum module and the function plate.

Example) ZR120S1-K15MZ-EC..... 1 pc.

* ZR1-RV1 1 pc.

⚠ Caution

Length of assembling mounting threads varies when adding function plate. Order from the mounting thread parts list for unit combination on page 678.
Order a plug (ZX1-MP1) separately in order to plug the PD and PS ports that are no longer used due to the addition of function plate.

Construction

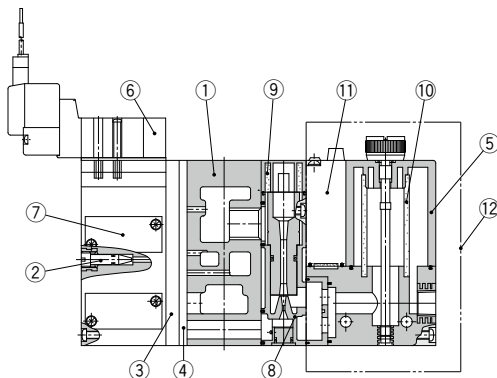

Component Parts

No.	Description	Material	Part Model
1	Manifold base	Aluminum alloy	
2	Release flow rate adjusting needle	Stainless steel	ZR1-NA ^(Note 2)
3	Function plate	PBT	Refer to page 658.
4	Individual spacer	PBT	Refer to page 658.
5 ^(Note 1)	Filter case	Polycarbonate	Refer to page 649.
6	Pilot valve assembly	—	Refer to page 639.
7	Valve body assembly	—	Refer to page 639.

No.	Description	Material	Part Model
8	Ejector assembly	—	Refer to page 639.
9	Silencer	PVA sponge	Refer to page 639.
10	Filter element	PVA sponge	ZR1-FZ(30 μm)
11	Pressure switch for vacuum	—	ZSE2-OR- $\frac{15}{25}$ -□
12	Filter switch unit for replacement	—	ZR1-F□□□□-D

Note 1) Precautions on handling the filter case

1. The case is made of polycarbonate. Therefore, do not contact it or expose it to the following chemicals: paint thinner, carbon tetrachloride, chloroform, acetic ester, aniline, cyclohexane, trichloroethylene, sulfuric acid, lactic acid, water soluble cutting oil (alkalinoic), etc.

2. Do not expose it to direct sunlight.

Note 2) Turning the release flow rate adjusting needle 2 full turns from the fully closed position renders the needle valve fully open. Do not turn more than two times since turning excessively may cause the needle fall off.

In order to prevent the needle from loosening and falling out, the release flow rate adjusting (ZR1-ND-L) lock nut is also available.

How to Order Solenoid Valves/Air Operated Valves

Air operated

SYJA3130

Solenoid valve

ZR1-SYJ3233 - □ - □ - □ - □ - X126 - □

SYJ3133 - □ - □ - □ - □ - □

rated voltage

5	DC24V
6	DC12V
V	DC6V
S	DC5V
R	DC3V
1	AC100V(50/60Hz)
3	AC110V(50/60Hz)

Electrical entry

L	L plug connector type	Lead wire: 0.3 m
LN		Without lead wires
LO		Without connector
M	M plug connector type	Lead wire: 0.3 m
MN		Without lead wires
MO		Without connector
G	Grommet type	Lead wire: 0.3 m/Apples only to DC
H		Lead wire: 0.6 m/Apples only to DC

CE/UKCA-compliant

Nil	Standard
Q	CE/UKCA-compliant (DC only)

Manual override

Nil	Non-locking push type
D	Slotted locking type

Light/Surge voltage suppressor

Nil	None
Z	With light and surge voltage suppressor
S	With surge voltage suppressor (DC only)

For details on the SYJ3000 series, [click here](#).

Note) Mounting screw and pilot valve gasket are included.

How to Order Replacement Parts

How to Order Valve Body Assembly

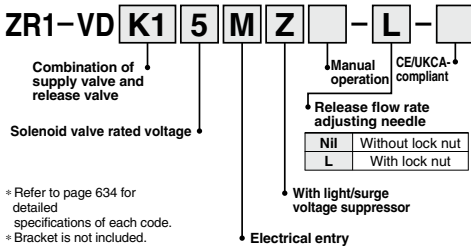

* Refer to page 634 for detailed specifications of each code.
* Bracket is not included.

How to Order Ejector Assembly

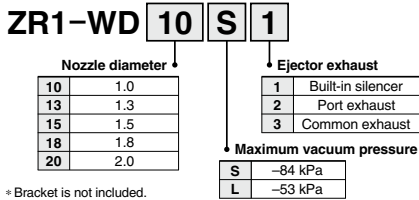

* Bracket is not included.

Pressure Switch for Vacuum + Suction Filter Unit

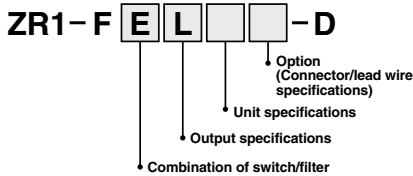

* Refer to page 649 for detailed specifications of each code.
* Bracket is not included.

How to Order Pilot Valves

Combination Symbol	Components		Model
	Supply valve	Release valve	
K1	Double solenoid valve N.C. (SYJ3233)	Single solenoid valve N.C. (SYJ3133)	Refer to "How to Order" below. Supply: ZR1-SYJ3233-□□□□-X126 Release: SYJ3133-□□□□
K3	Air operated N.C. (SYJA3130)	Air operated N.C. (SYJA3130)	SYJA3130

Bracket assembly

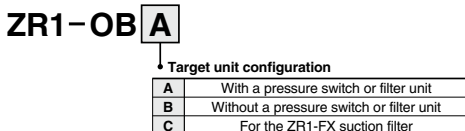

How to Order Silencer Element

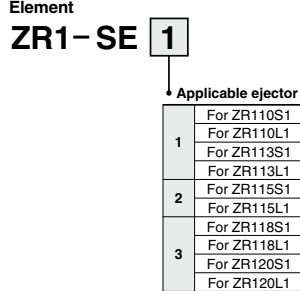

Silencer assembly (Case, Element, Mounting screw)

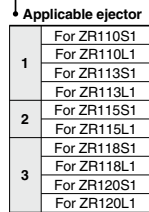

Silencer case assembly for port exhaust (Case, Mounting screw)

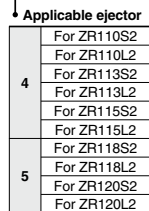

Silencer case assembly for centralized exhaust (Case, Mounting screw)

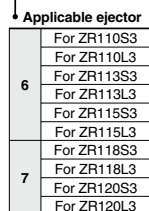

ZR Series

Valve Unit : ZR1-V□□□□□-□-□

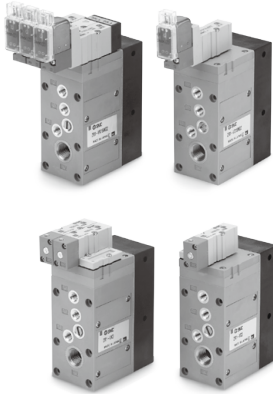

Specifications

Valve unit part no.	ZR1-V□□□□□-□-□	
Components	Supply valve	Release valve
Operating method	Pilot operated	Pilot operated
Combination of supply valve and release valve	Refer to the combination of supply valve and release valve below.	
Supply pressure range of air pressure/vacuum pressure supply (PV) port	-0.1 to 0.6 MPa (PS port pressure or less)	
Supply pressure range of release pressure supply (PD) port	0.05 to 0.6 MPa (PS port pressure or less)	
Supply pressure range of pilot pressure supply (PS) port	0.25 to 0.6 MPa	
Supply pressure range of pilot pressure supply (PA, PB) ports for supply and release <small>Note</small>	PS port pressure to 0.6 MPa	
Main valve effective area (mm²)	8.2	0.96
Main valve effective area (Cv)	0.45	0.053
Maximum operating frequency	5 Hz	
Operating temperature range	5 to 50°C	

Note) Combination of supply valve and release valve: K3, C2

The supply and release valves of this product have a structure which uses the pressure of the pilot pressure supply (PS) port to operate them. Be sure to supply a pressure that is the pressure of the pilot pressure supply (PS) port or more and 0.6 MPa or less to the pilot pressure supply (PA, PB) ports for supply and release.

Solenoid Valve/Specifications

Solenoid valve		SYJ3133-□□□□, SYJ3233-□□□□-X126	
Rated voltage V	DC	24, 12, 6, 5, 3	
	AC 50/60 Hz	100, 110	
Allowable voltage range		Rated voltage ±10%	
Power consumption W	DC	0.35 (With indicator light: 0.4)	
	AC	100 V	0.78 (With indicator light: 0.81)
Apparent power VA	AC	110 V	0.86 (With indicator light: 0.89)
	Electrical entry		L/M plug connector, Grommet
Light/Surge voltage suppressor		Available, Not available (at grommet)	
Manual operation		Non-locking push type, Locking slotted type	

Combination of Supply Valve and Release Valve

Combination symbol	Vacuum switch valve	Release valve	Weight (kg)
K1	Double SOL. (SYJ3233-X126)	N.C. (SYJ3133)	0.34
K2	N.C. (SYJ3133)	N.C. (SYJ3133)	0.27
K3	Air operated (SYJA3130)	Air operated (SYJA3130)	0.194
C1	N.C. (SYJ3133)		0.22
C2	Air operated (SYJA3130)		0.174
C3	N.C. (SYJ3133)		0.21

* Weight includes Bracket B. (Solenoid valve: 24 VDC, M plug connector type)

How to Order

Refer to page 634 for further part no. information.

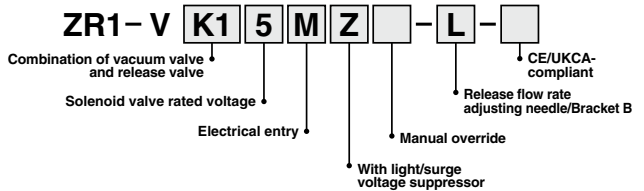

Large Size Vacuum Module: ZR Series Ejector System

Ejector Unit/ZR1-W□□□-□

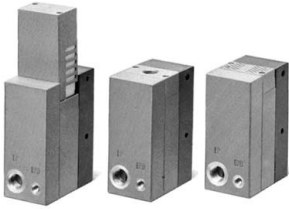

Model/Max. Vacuum Pressure -84 kPa (S: Standard type)

Model	Nozzle dia. (mm)	Maximum suction flow rate (L/min (ANR))	Air consumption (L/min (ANR))	Weight (With bracket) (kg)
ZR1-W10S□	1.0	25	53	0.132
ZR1-W13S□	1.3	42	86	0.134
ZR1-W15S□	1.5	63	102	0.136
ZR1-W18S□	1.8	74	155	0.154
ZR1-W20S□	2.0	95	194	0.156

Model/Max. Vacuum Pressure -53 kPa (L: Large flow type)

Model	Nozzle dia. (mm)	Maximum suction flow rate (L/min (ANR))	Air consumption (L/min (ANR))	Weight (With bracket) (kg)
ZR1-W10L□	1.0	44	53	0.133
ZR1-W13L□	1.3	55	86	0.133
ZR1-W15L□	1.5	88	102	0.135
ZR1-W18L□	1.8	105	155	0.155
ZR1-W20L□	2.0	132	194	0.154

Common Specifications

Supply pressure range	0.2 to 0.55 MPa
Standard supply pressure	0.45 MPa
Operating temperature range	5 to 50°C
Model (Ejector exhaust method)*	Code 1: Built-in silencer — For unit and manifold
	Code 2: Individual exhaust — For unit and manifold

* How to Order: Code 1 and 2 are the suffixes in the ordering number to indicate the exhaust method.
 (Note) Operation outside of the specified supply pressure and operating temperature range may cause a serious accident or damage.

Symbol

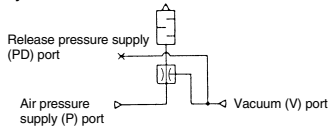

How to Order

ZR1-W 20 S 1 - □

Nozzle diameter

10	1.0
13	1.3
15	1.5
18	1.8
20	2.0

Bracket B

Nil	With Bracket B
N	Without Bracket B

Ejector exhaust

1	Built-in silencer
2	Individual exhaust*

Maximum vacuum pressure

S	-84 kPa
L	-53 kPa

* Port size:
 RC 1/4 (Nozzle dia. 1.0 to 1.5)
 RC 3/8 (Nozzle dia. 1.8, 2.0)

Characteristics (Representative value)

Ejector Unit/Standard Type (S): Max. Vacuum Pressure -84 kPa

At 0.45 MPa

ZR1-W10S1 Exhaust characteristics **Flow rate characteristics**

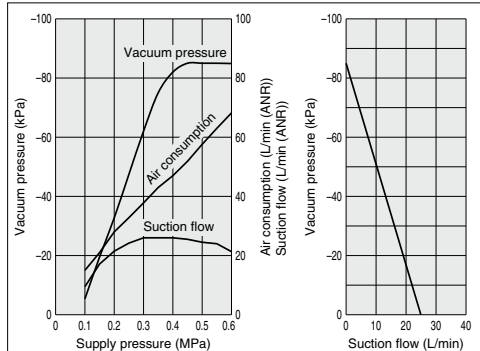

ZR1-W18S1 Exhaust characteristics **Flow rate characteristics**

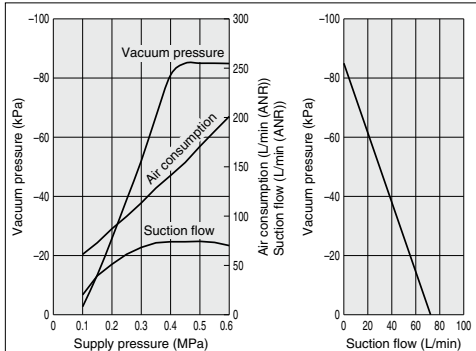

ZR1-W13S1 Exhaust characteristics **Flow rate characteristics**

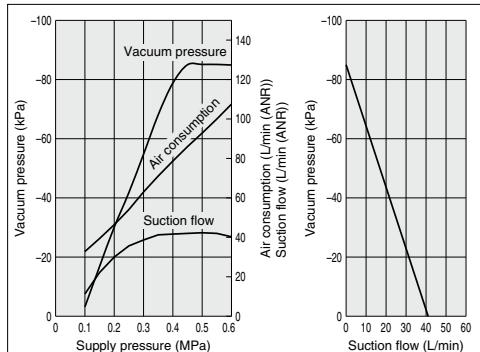

ZR1-W20S1 Exhaust characteristics **Flow rate characteristics**

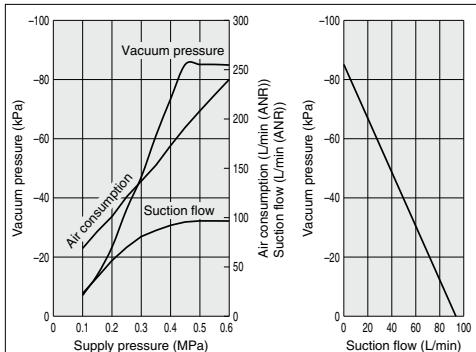

ZR1-W15S1 Exhaust characteristics **Flow rate characteristics**

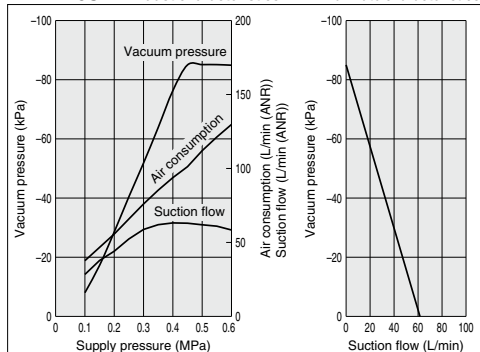

Ejector Unit/Large Flow Type (L): Max. Vacuum Pressure –53 kPa

At 0.45 MPa

ZR1-W10L1 Exhaust characteristics

Flow rate characteristics

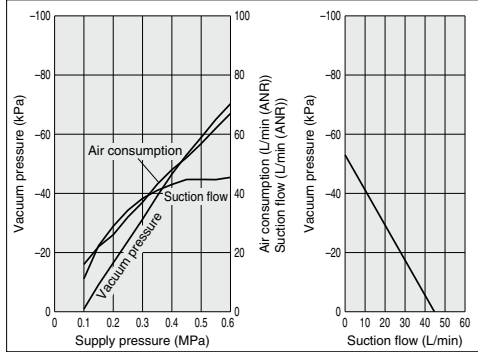

ZR1-W18L1 Exhaust characteristics

Flow rate characteristics

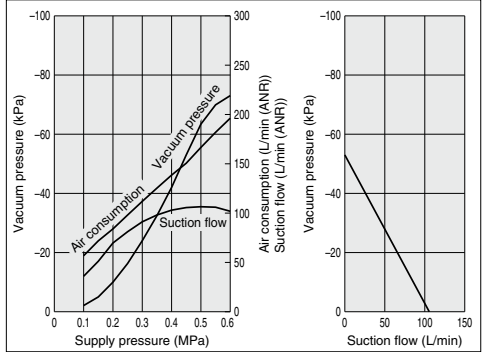

ZR1-W13L1 Exhaust characteristics

Flow rate characteristics

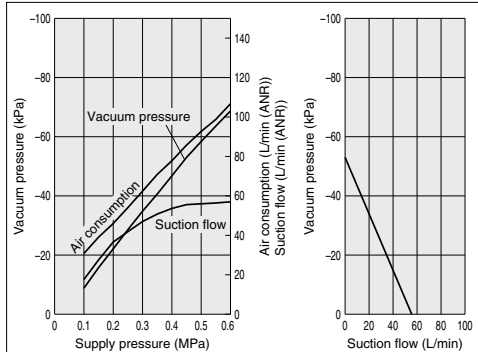

ZR1-W20L1 Exhaust characteristics

Flow rate characteristics

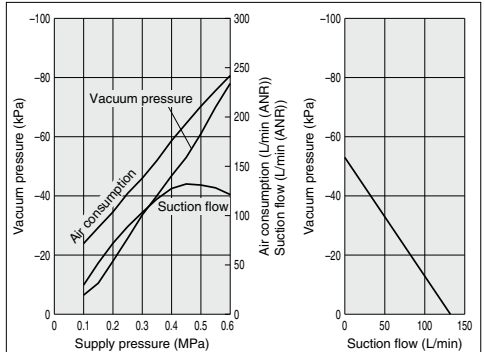

ZR1-W15L1 Exhaust characteristics

Flow rate characteristics

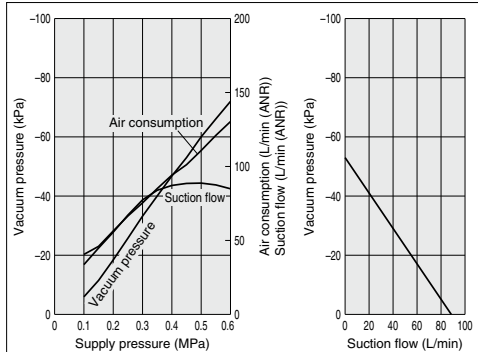

How to Read Flow Rate Characteristics Graph

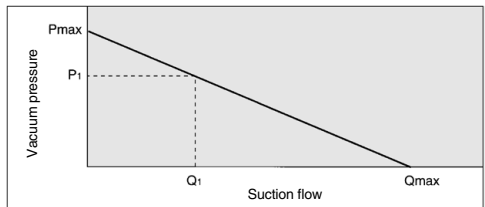

Flow rate characteristics are expressed in ejector vacuum pressure and suction flow. If suction flow rate changes, the vacuum pressure will also be changed. Normally this relationship is expressed in ejector standard use. In graph, P_{max} is max. vacuum pressure and Q_{max} is maximum suction flow. The values are specified according to catalog use. Changes in vacuum pressure are expressed in the below order.

1. When ejector suction port is covered and made airtight, suction flow becomes 0 and vacuum pressure is at maximum value (P_{max}).
2. When suction port is opened gradually, air can flow through, (air leakage), suction flow increases, but vacuum pressure decreases. (condition P₁ and Q₁)
3. When suction port is opened further, suction flow moves to maximum value (Q_{max}), but vacuum pressure is near 0 (atmospheric pressure).

Based on the above, when vacuum port (vacuum piping) has no leakage, vacuum pressure becomes maximum, and vacuum pressure decreases as leakage increases. When leakage value is the same as max. suction flow, vacuum pressure is near 0. In the case when ventrative or leaky work should be adsorbed, please note that vacuum pressure will not rise.

ZR Series

Ejector Unit

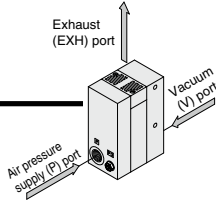

Nozzle Dia./ $\phi 1.0, \phi 1.3, \phi 1.5, \phi 1.8, \phi 2.0$

Nozzle dia./ $\phi 1.0, \phi 1.3, \phi 1.5$

ZR1-W¹⁰₁₃□□□□

For port exhaust

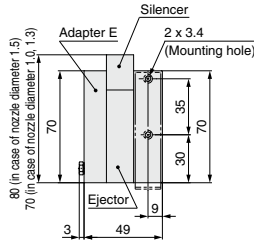
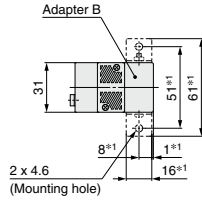
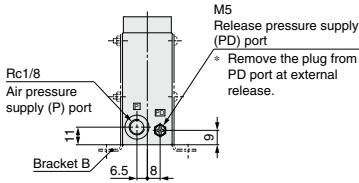
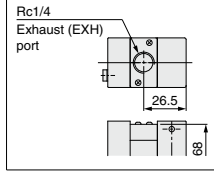

Circuit diagram

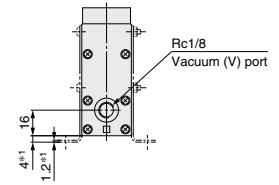
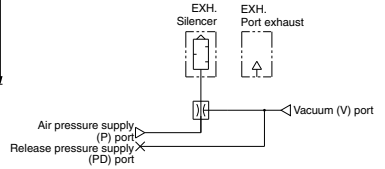

Nozzle dia./ $\phi 1.8, \phi 2.0$

ZR1-W¹⁸₂₀□□□□

For port exhaust

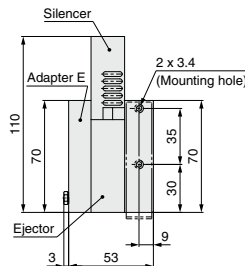
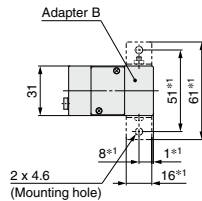
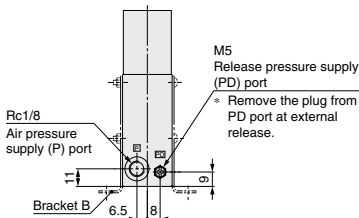
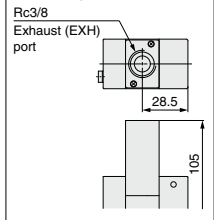

Circuit diagram

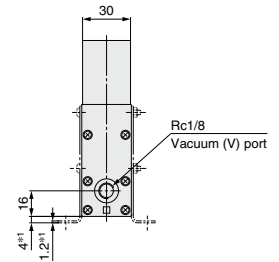
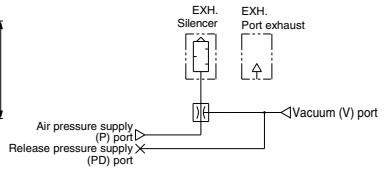

Note) Dimensions marked with "±0.1" are those after the bracket B is mounted.
Bracket B part no.: ZR1-0BB

Pressure Switch Unit for Vacuum/Pressure Switch for Vacuum: ZSE2-0R-□□

Quick response: 10 mS

**Compact size: 39H x 20W x 15D
(except the connecting portion)**

Improved wiring: Connector type

Uses a carrier diffusion semiconductor pressure sensor

**Pressure detector
(A carrier diffusion semiconductor pressure sensor is used.)**

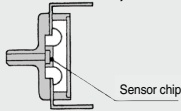

Specifications

Pressure switch for vacuum part no.	ZSE2-0R-15□	ZSE2-0R-55□
Fluid	Air	
Rated pressure range/Set pressure range	0 to -101 kPa	
Proof pressure	500 kPa	
Hysteresis	3% F.S. or less (Fixed)	
Temperature characteristics (Based on 25°C)	± 3% F.S. or less	
Operating voltage	12 to 24 VDC (Ripple ±10% or less)	
Output	NPN Open collector 30 V, 80 mA	PNP Open collector 80 mA
Indicator light	Lights up when ON	
Current consumption	17 mA or less (when 24 VDC is ON)	
Proof pressure (Max. operating pressure)	0.5 MPa*	
Operating temperature range	5 to 50°C	

* When using ejector system, instantaneous pressure up to 0.5 MPa will not damage the switch.

Note 1) Operation outside of the maximum operating pressure and operating temperature range may cause a serious accident or damage.

Note 2) For details about wiring, refer to the Operation Manual that can be downloaded from our website (<https://www.smcworld.com>).

How to Order

ZSE2 - 0R - 15 L

Output specifications

15	NPN Open collector 30V 80mA
55	PNP Open collector 80mA

Piping specifications

Nil	Grommet type	Lead wire length 0.6 m
L		Lead wire length 3 m
C	Connector type	Lead wire length 0.6 m
CL		Lead wire length 3 m
CN		W/o lead wire

With Connector/How to Order

●Without lead wire (housing and 3 sockets)ZS-10-A

●With lead wireZS-10-5A-□

Lead wire length

Nil	0.6 m
30	3 m
50	5 m

Note) When requiring a switch with lead wire of 5 m, indicate separately the model numbers of the connector type switch without lead wire and the connector assembly with 5 m lead wire.

Example) ZSE2-0R-15CN 1 pc.

ZS-10-5A-50 1 pc.

* Refer to the **WEB catalog** for detailed specifications of pressure switches for vacuum.

Pressure Switch Unit for Vacuum/Pressure Switch for Vacuum: ZSE2-0R-□□

Guidelines for Use of Pressure Switch Unit for Vacuum

System circuit for work adsorption

Ejector type

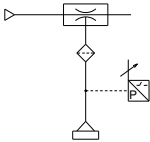

Vacuum pump type

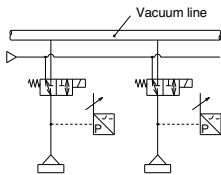

When pads and switches are common to one vacuum source, sometimes there is a possibility, depending on the number of adsorption and non-adsorption applications at each point in time, that the switches will not work within the range of set pressures due to pressure variations from the vacuum source. In particular, when small diameter nozzles are used for adsorption, the switches are greatly influenced by pressure variations. In order to remedy this situation, the following circuit is recommended.

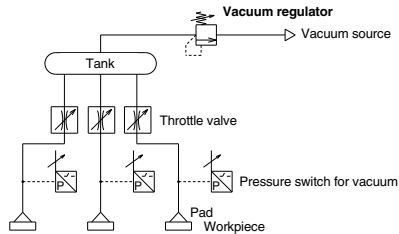

- Adjust the throttle valve to reduce the pressure fluctuation between adsorption and non-adsorption.
- Stabilize the source pressure by providing a tank and a vacuum regulator.
- If a vacuum switch valve is inserted into individual lines and false adsorption occurs, each valve should be turned OFF to minimize the influences on other pads.

Pressure Switch for Vacuum: ZSE2-0R-□□

ZSE2-0R-□
ZSE2-0R-□L

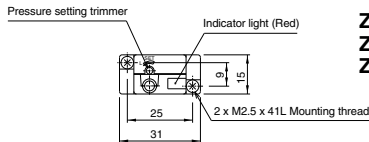

ZSE2-0R-□C
ZSE2-0R-□CL
ZSE2-0R-□CN

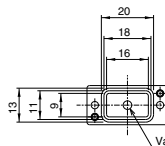
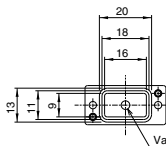
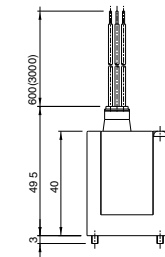
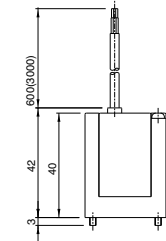
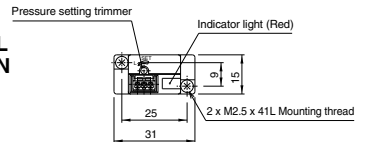

How to Set Vacuum Pressure

- Pressure trimmer selects the ON pressure. Clockwise rotation increases high vacuum set point.

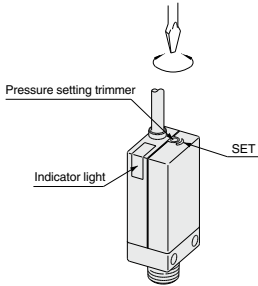

- When using the switch to confirm correct adsorption, the vacuum pressure is set to the minimum value to reliably adsorb. If the value is set below the minimum, the switch will be turned ON even when adsorption has failed or is insufficient. If the pressure is set too high, the switch may not operate stably even though it may adsorb correctly.

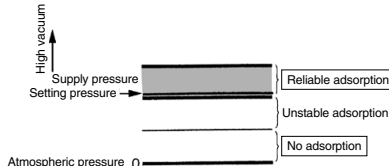

Hysteresis

Hysteresis is the actual pressure variance from set pressure occurring when the output signal turns from ON to OFF. The set pressure is the pressure selected to switch from OFF to ON mode.

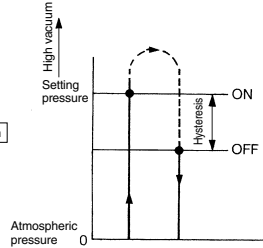

How to Use Connector

1. Attaching and detaching connectors

- When assembling the connector to the switch housing, push the connector straight onto the pins until the level locks into the housing slot.
- When removing the connector from the switch housing, push the lever down to unlock it from the slot and then withdraw the connector straight off of the pins.

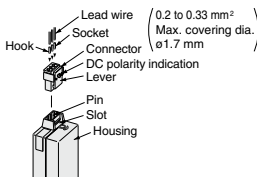

2. Crimping of lead wires and sockets

Strip 3.2 to 3.7 mm at the end of the lead wires, insert the ends of core wires evenly into the sockets, and then crimp with a crimping tool. When this is done, take care that the coverings of the lead wires do not enter the core wire crimping area. (Crimping tool: model no. DXT170-75-1)

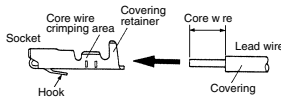

3. Attaching and detaching of socket to connector with lead wire

• Attaching

Insert the sockets into the square holes of the connector (with +, 1, 2, - indication), and continue to push the sockets all the way end. (When they are pushed in their hooks open and they are locked automatically.) Then confirm that they are locked by pulling lightly on the lead wires.

• Detaching

To detach a socket from a connector, pull out the lead wire while pressing the socket's hook with a stick having a thin tip (about 1 mm). If the socket will be used again, first spread the hook outward.

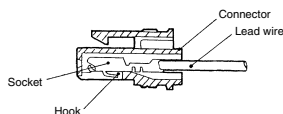

Precautions

- Be sure to read this before handling the products.
- Refer to page 33 for safety instructions and pages 34 to 36 for vacuum equipment precautions.

Mounting

Warning

1. Do not give an excessive impact load. Do not drop, bump or apply excessive impact (1000 m/s²) when handling. Even if the switch body is not damaged, the switch may suffer internal damage that will lead to malfunction.
2. Hold the product from the body side when handling. When raising and moving the product, do not raise it by holding the lead wire only, but hold the body. It may cause malfunction due to broken contacts.

Vacuum Pressure Switch Unit/Digital Pressure Switch for Vacuum:ZR1-ZSE30A-00-□-□□

How to Order

Refer to the [Web Catalog](#) for details.



ZR1-ZSE30A-00-N-M□

Symbol	Output		Analog output	
	Type	Point	Voltage	Current
N	NPN	1	—	—
P	PNP	1	—	—
A	NPN	2	—	—
B	PNP	2	—	—
C	NPN	1	○	—
D	NPN	1	—	○
E	PNP	1	○	—
F	PNP	1	—	○

Option 1 (Connector/Lead wire specifications)

Nil	Without lead wire
L	Lead wire with connector (Length 2 m)

Display unit

Nil	With unit display switching function
M	Fixed SI unit
p	With unit display switching function (Initial value psi)

Note 1) This is no longer sold for use in Japan due to the Weight and Measure Act (implemented October, 1999).

Note 2) Fixed unit: kPa

Specifications

Rated pressure range	0.0 to -101.0 kPa
Set pressure range	10.0 to -105.0 kPa
Withstand pressure	500 kPa
Minimum unit setting	0.1 kPa
Applicable fluid	Air
Power supply voltage	12 to 24 VDC $\pm 10\%$ (with power supply polarity protection)
Current consumption	40 mA (at no load)
Switch output	NPN or PNP open collector 1 output NPN or PNP open collector 2 outputs (selectable)
Maximum load current	80 mA
Maximum applied voltage	28 V (at NPN output)
Residual voltage	1 V or less (with load current of 80 mA)
Response time	2.5 ms or less (with anti-chattering function: 20, 100, 500, 1000, 2000 ms)
Short circuit protection	Yes
Repeatability	$\pm 0.2\%$ F.S. ± 1 digit
Hysteresis mode	Variable (0 to variable)
Window comparator mode	Variable (0 to variable)
Linearity	$\pm 1\%$ F.S. or less
Output impedance	Approx. 1 k Ω
Linearity	$\pm 1\%$ F.S. or less
Load impedance	Maximum load impedance: Power supply voltage 12 V: 300 Ω , Power supply voltage 24 V: 600 Ω Minimum load impedance: 50 Ω
Display	4-digit, 7-segment, 2-color LCD (Red/Green) Sampling cycle: 5 times/sec.
Display accuracy	$\pm 2\%$ F.S. ± 1 digit (Ambient temperature of 25°C)
Indicator light	Lights up when switch output is turned ON. (OUT1: Green, OUT2: Red)
Enclosure	IP40
Operating temperature range	Operating: 0 to 50°C, Stored: -10 to 60°C (No freezing or condensation)
Operating humidity range	Operating/Stored: 35 to 85% RH (No condensation)
Withstand voltage	1000 VAC for 1 minute between terminals and housing
Insulation resistance	50 M Ω or more (500 VDC measured via megohmmeter) between terminals and housing
Temperature characteristics	$\pm 2\%$ F.S. (Based on 25°C)
Lead wire	Oilproof heavy-duty vinyl cable, 3 cores $\phi 3.5$, 2 m 4 cores Connector area: 0.15 mm ² (AWG26) Insulator O.D.: 1.0 mm
Standards	CE/UKCA Marking, RoHS compliance

3-step setting

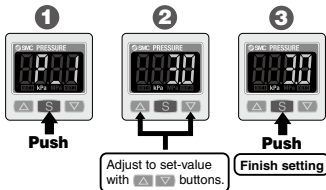

Power-saving function

Power consumption is reduced by turning off the monitor. (Reduce power consumption by up to 20%.)

Note 1) When analog voltage output is selected, analog current output cannot be used together.
Note 2) When analog current output is selected, analog voltage output cannot be used together.
Note 3) If the applied pressure fluctuates around the set value, the hysteresis must be set to a value more than the fluctuating width, otherwise, chattering will occur.

*The vacuum pressure switch mounted on this product is equivalent to our SMC product, the ZSE30A series compact digital pressure switch.

●Pressure switch correspondence table

Digital pressure switch ZSE30A series

Large size vacuum module ZR series

Vacuum pressure switch (For ZR)

ZSE30A-00-□-□-□

ZR1※※※※-※※※※※※※※-D-□-□-□-□-□

ZR-ZSE30A-00-□-□-□

For details about vacuum pressure switch functions, refer to the ZSE30A series in the [Web Catalog](#).

Lead wire specifications
Unit specifications
Output specifications

Pressure Switch for Vacuum + Suction Filter Unit: ZR1-F□□□□-□

Combination unit of vacuum pressure switch for vacuum pressure detection and suction filter to protect the unit from dust and contamination.

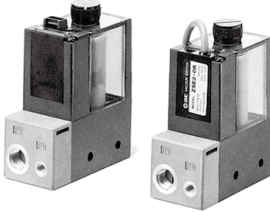

Filter case

Caution

- The case is made of polycarbonate. Therefore, do not contact it or expose it to the following chemicals: paint thinner, carbon tetrachloride, chloroform, acetic ester, aniline, cyclohexane, trichloroethylene, sulfuric acid, lactic acid, water soluble cutting oil (alkalinal), etc.
- Do not expose it to direct sunlight.

How to Replace Elements

When an element becomes clogged, adsorption performance and response times are degraded. Stop operation and replace element. (Element no. ZR1-FZ). Please ensure that gasket is in slot before re-installation.

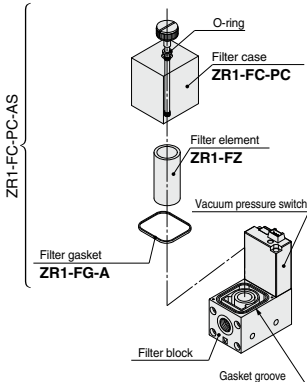

Specification

Unit no.		ZR1-F□□□□-□
Suction filter	Rated pressure range/Set pressure range	-100 to 100 kPa
	Proof pressure	500 kPa
	Operating temperature range	5 to 50°C
	Filtration degree	30 μm
Filtration material		PVA sponge
Pressure switch for vacuum		Refer to pages 645 and 648 regarding pressure switch for vacuum.

Note) If not operated within the specified range of pressure and temperature, trouble may be caused.

Combination of Pressure Switch for Vacuum and Suction Filter

Combination symbol	Suction filter	Pressure switch for vacuum	Weight (with bracket A) (kg)
E	●	ZSE2	0.15
D	●	ZSE30A	0.23
F	●	—	0.15

How to Order

ZR1 - F □ □ □ □ - □

Combination of pressure switch/filter

D	Digital pressure switch for vacuum (ZSE30A) + Filter
E	Pressure switch for vacuum (ZSE2) + Filter
F	Filter

*The filter mounted on the product is a simplified one. When used in an environment with a lot of dust, the built-in filter is likely to be clogged soon. The use with the ZFA, ZFB and ZFC series is recommended.

Output specifications

Digital pressure switch for vacuum (ZSE30A) specifications (D)

N	NPN open collector 1 output
P	PNP open collector 1 output
A	NPN open collector 2 outputs
B	PNP open collector 2 outputs
C	NPN open collector 1 output + Analog voltage output
D	NPN open collector 1 output + Analog current output
E	PNP open collector 1 output + Analog voltage output
F	PNP open collector 1 output + Analog current output

Pressure switch for vacuum (ZSE2) specifications (E)

Nil	NPN open collector 1 output
55	PNP open collector 1 output

Filter specifications (F)

Nil	No setting
-----	------------

How to order

When requiring a switch with lead wire of 5 m, indicate separately the model numbers of a pressure switch unit for vacuum without a lead wire connector and the 5 m lead wire connector. Ex.) ZR1□□□□-□□□□□□-□CN 1 pc.
* ZS-10-5A-50 2 pcs.

(1) Lead wire length for pressure switch for vacuum connector assembly

ZS - 10 - 5A - □

Lead wire length	
Nil	0.6 m
30	3 m
50	5 m

(2) Lead wire length for digital pressure switch for vacuum connector assembly

ZS - 38 - 3 L

Lead wire core	
3	3 cores, 1 output, 2 m (Output specifications: N, P)
4	4 cores, 2 outputs, 2 m (Output specifications: A, B, C, D, E, F)

Bracket A

Nil	With Bracket A
N	Without Bracket A

Lead wire specifications

Digital pressure switch for vacuum (ZSE30A) specifications (D)

Nil	Without lead wire
L	Lead wire with connector (Length 2 m)

Refer to "Table (2)" for part numbers for lead wire with connector.

Pressure switch for vacuum (ZSE2) specifications (E)

Nil	Grommet/Lead wire (Length 0.6 m)
L	Grommet/Lead wire (Length 3 m)
C	Lead wire with connector (Length 0.6 m)
CL	Lead wire with connector (Length 3 m)
CN	Without lead wire with connector

Refer to "Table (1)" for part numbers for lead wire with connector.

Filter specifications (F)

Nil	No setting
-----	------------

Unit specifications

Digital pressure switch for vacuum (ZSE30A) specifications (D)

Nil	With unit switching function
M	SI unit only
P	With unit switching function (Initial value psi)

Note 1) This is no longer sold for use in Japan due to the Weight and Measure Act (implemented October, 1999).
Note 2) Fixed unit: kPa

Pressure switch for vacuum (ZSE2) specifications (E)

Nil	No setting
-----	------------

Filter specifications (F)

Nil	No setting
-----	------------

ZR Series

Pressure Switch for Vacuum + Suction Filter Unit: ZR1-F□□□□-□

Dimensions: ZR1-F□□□□-□

ZR1-FE□□□□-□

Circuit diagram

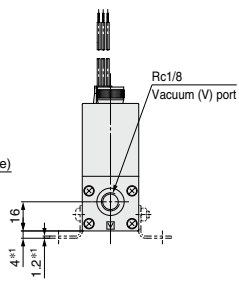
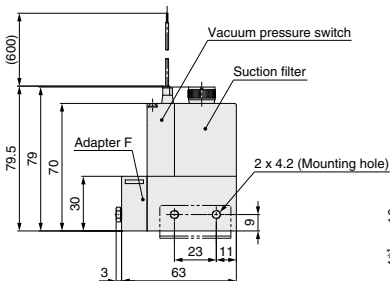
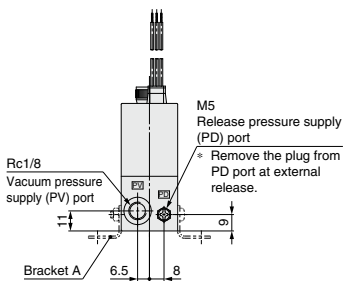
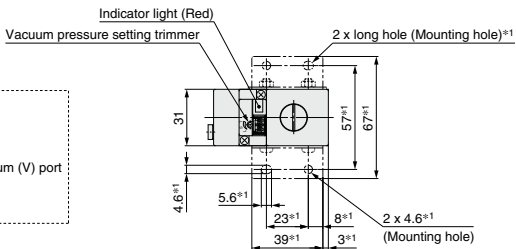
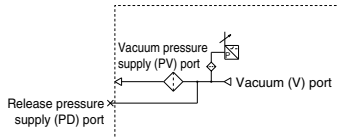

ZR1-FD□□□□

Circuit diagram

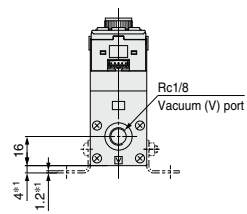
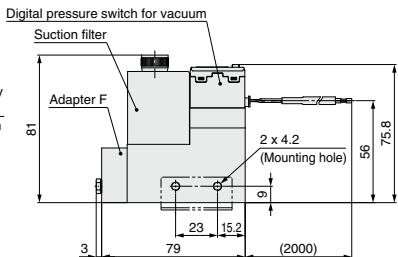
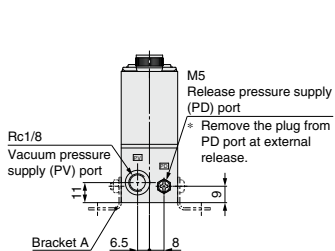
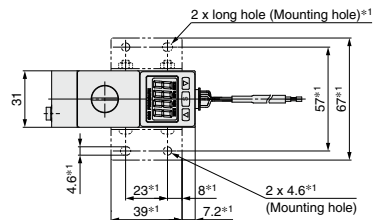
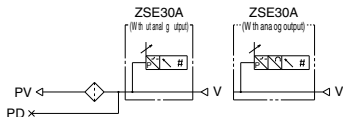

Note) Dimensions marked with "*±1" are those after the bracket A is mounted.
Bracket A part no.: ZR1-OBA

Suction Filter: ZR1-FX-□

ZR1-FX is to be used alone and cannot be combined with other units.



Specification

Model	ZR1-FX-□
Operating pressure range	-0.1 to 0.5 MPa
Operating temperature range	5 to 50°C
Filtration efficiency	30 μm
Element	PVA sponge
Weight (With bracket)	0.1 kg

How to Order

ZR1-FX-□

Bracket C

	With bracket C
Nil	
N	

Filter case

Caution

- The case is made of polycarbonate. Therefore, do not use it with or expose it to the following chemicals: paint thinner, carbon tetrachloride, chloroform, acetic ester, aniline, cyclohexane, trichloroethylene, sulfuric acid, lactic acid, water soluble cutting oil (alkaline), etc.
- Do not expose it to direct sunlight.

Dimensions: ZR1-FX-□

Circuit diagram

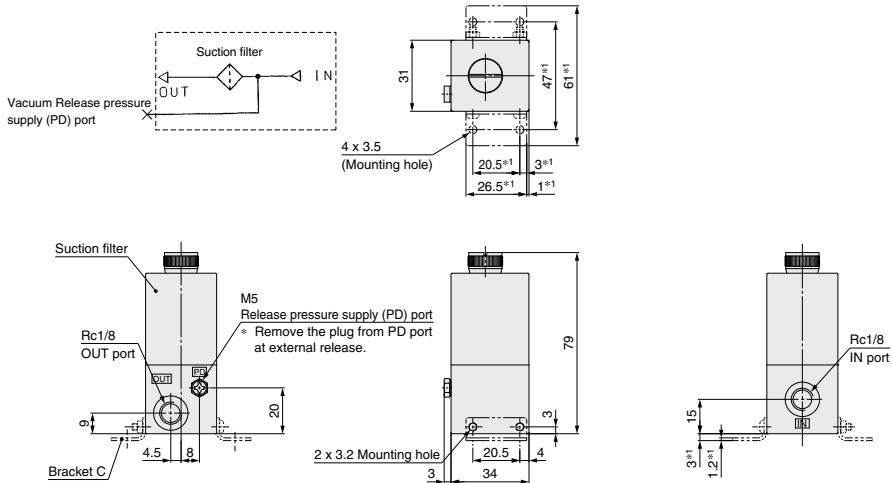

Note) Dimensions marked with "*1" are those after the bracket C is mounted.
Bracket C part no.: ZR1-OBC

ZR Series

Ejector System Complete Unit

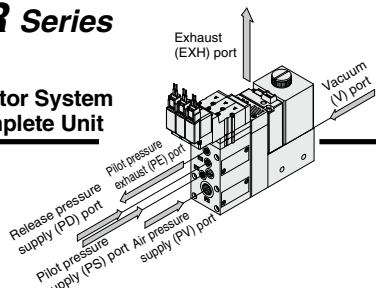

<Components> Ejector + Valve + Pressure Switch for Vacuum + Filter

Nozzle dia. $\phi 1.0, \phi 1.3, \phi 1.5$

ZR10 □1-K1M□□-E□□-□-□
ZR13 □1-K1M□□-E□□-□-□
ZR15 □1-K1M□□-E□□-□-□

Circuit diagram

Pressure switch for vacuum (E)

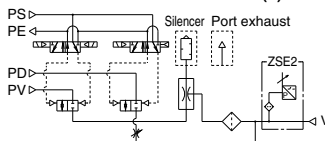

For port exhaust

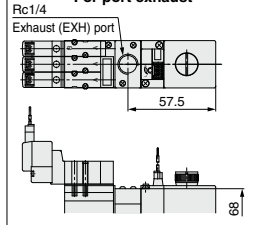

A: Release flow adjusting needle with lock nut

(Needle fully open)

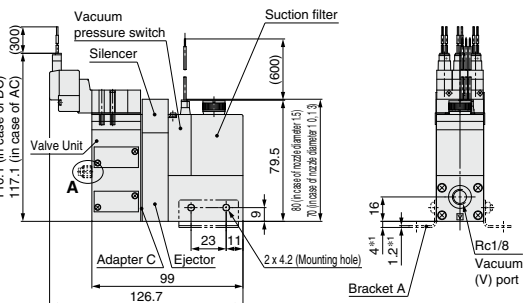
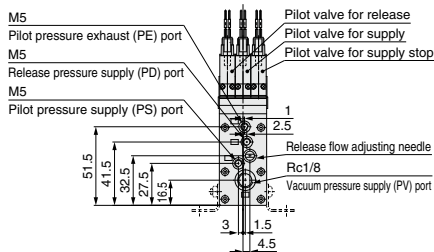
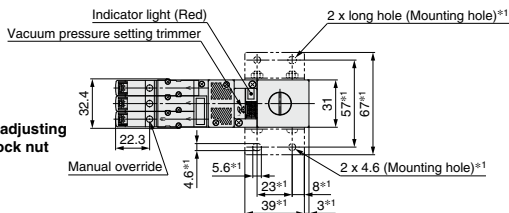

ZR10 □1-K1M□□-D□□□-□-□
ZR13 □1-K1M□□-D□□□-□-□
ZR15 □1-K1M□□-D□□□-□-□

For port exhaust

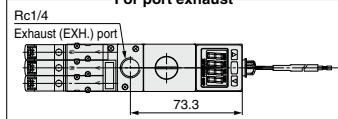

Circuit diagram

Digital pressure switch for vacuum (D)

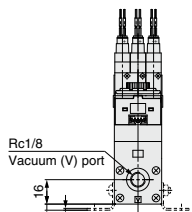
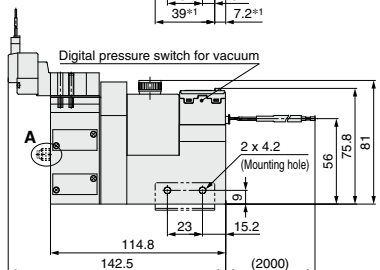
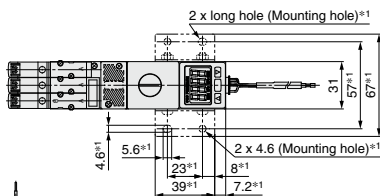
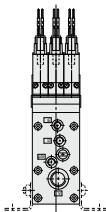
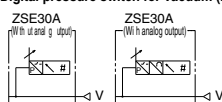

Nozzle dia./ $\phi 1.8, \phi 2.0$

ZR1¹⁸₂₀□1-K1□M□□-E□□-□-□

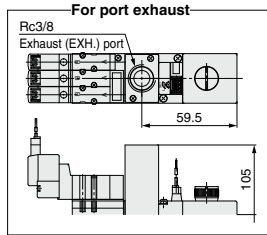

Note) Dimensions marked with "※1" are those after the bracket A is mounted.
Bracket A part no.: ZR1-0BA

A: Release flow adjusting needle with lock nut

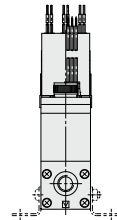
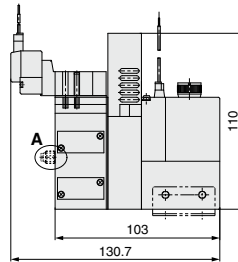
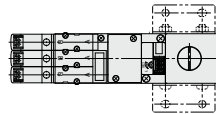
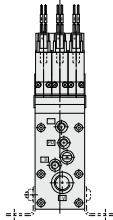
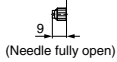

*Dimensions not indicated are identical to the drawings on page 652.

ZR1¹⁸₂₀□1-K1□M□□-D□□□-□-□

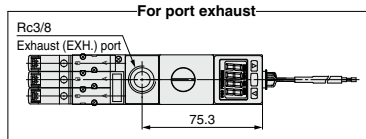

A: Release flow adjusting needle with lock nut

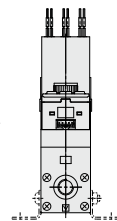
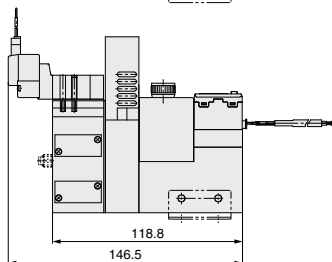
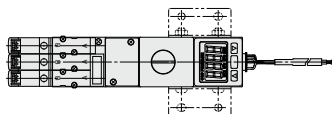
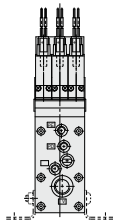
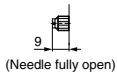

ZR Series

Ejector System

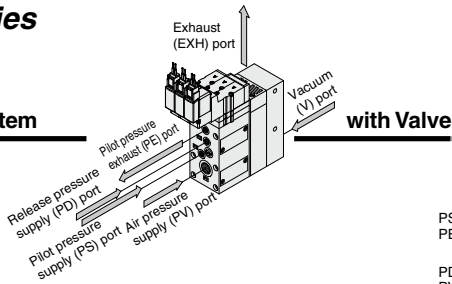

Circuit diagram

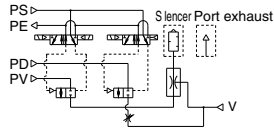

Nozzle dia./ø1.0, ø1.3, ø1.5

ZR1¹⁰₁₃ □ □ 1-K1 □ M □ □ □ □ □ □

For port exhaust

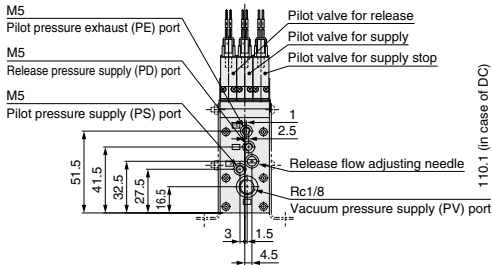
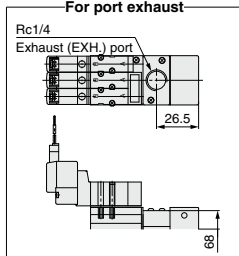

A: Release flow adjusting needle with lock nut

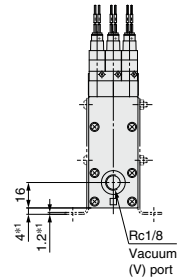
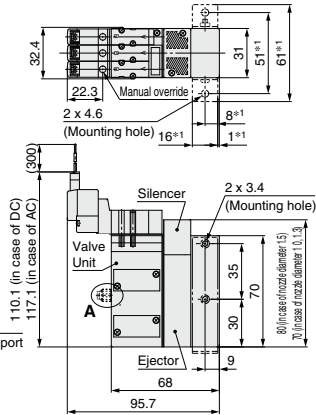
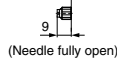

Note) Dimensions marked with "±1" are those after the bracket B is mounted.
Bracket B part no.: ZR1-0BB

Nozzle dia./ø1.8, ø2.0

ZR1¹⁸₂₀ □ □ 1-K1 □ M □ □ □ □ □ □

For port exhaust

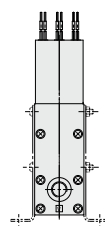
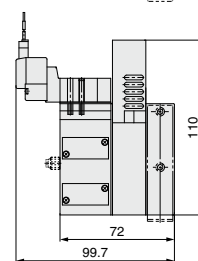
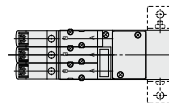
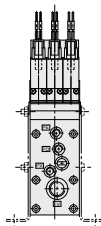
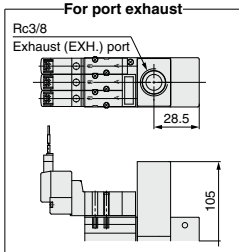

* Dimensions not indicated are identical to the drawings above.

ZR Series

Ejector System

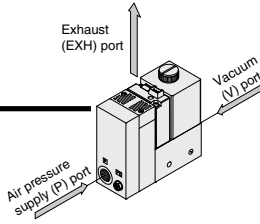

without Valve

Circuit diagram

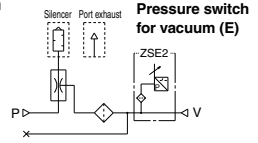

Nozzle dia./ $\phi 1.0, \phi 1.3, \phi 1.5$

ZR1¹⁰₁₃□1-E□□-□
15

For port exhaust

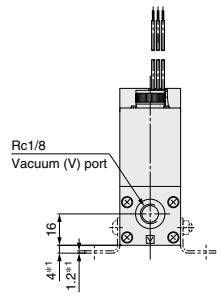
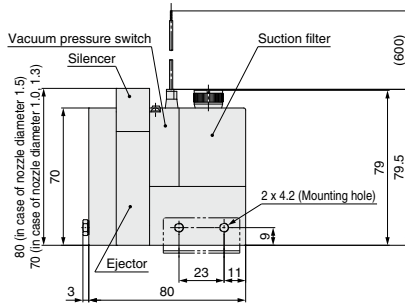
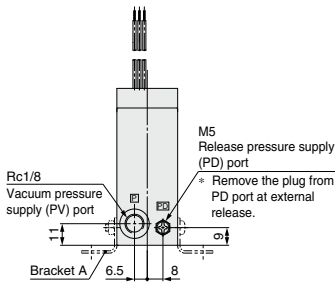
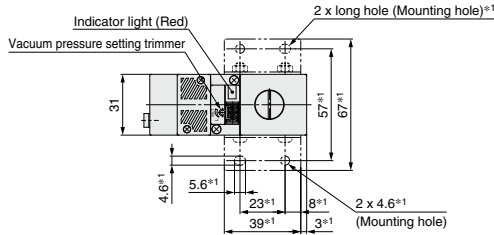
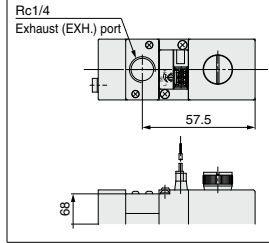

ZR1¹⁰₁₃□1-D□□□-□
15

For port exhaust

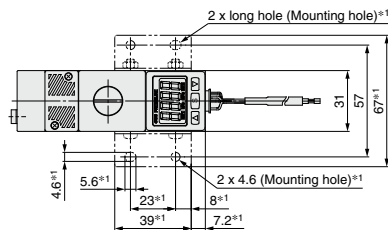
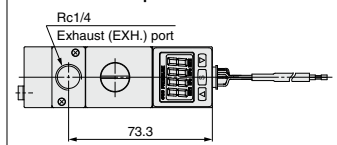

Digital pressure switch for vacuum (D)

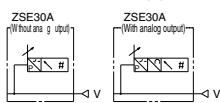

Digital pressure switch for vacuum

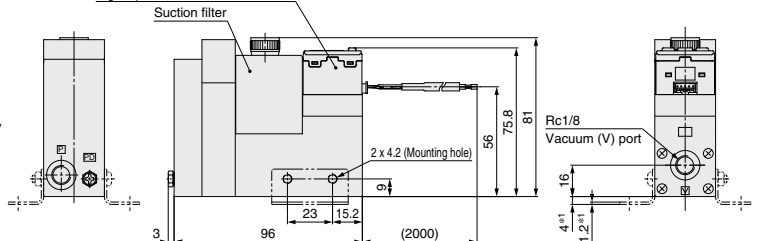

Nozzle dia./ $\phi 1.8, \phi 2.0$

ZR1¹⁸₂₀□1-E□□-□

Note) Dimensions marked with "1" are those after the bracket A is mounted.
Bracket A part no.: ZR1-OBA

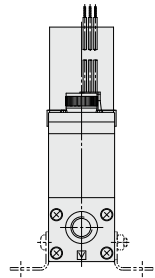
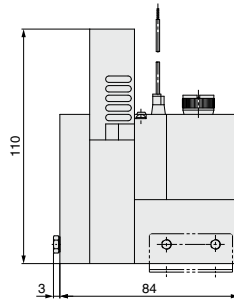
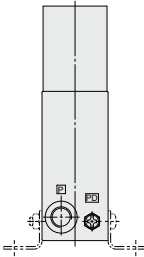
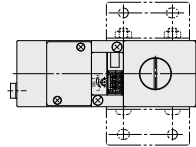
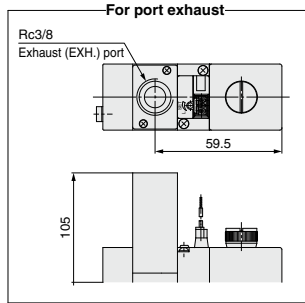

ZR1¹⁸₂₀□1-D□□□-□

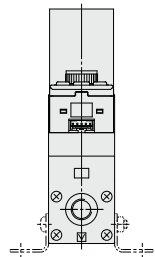
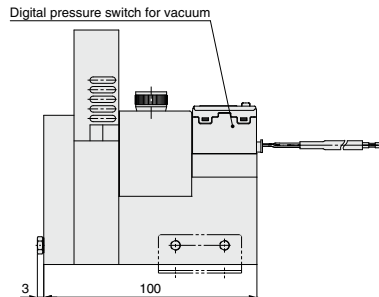
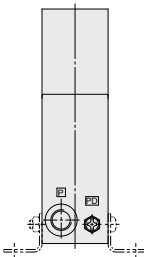
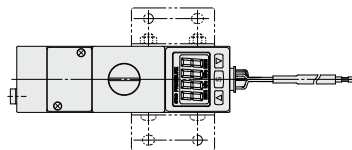
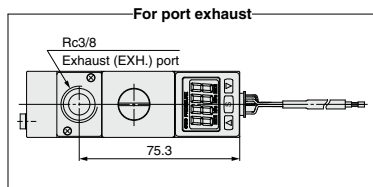

★ Dimensions not indicated are identical to the drawings above.

ZR Series

Ejector System/Manifold Specifications



Specifications

Max. number of units	Max. 6 stations
Port	Port size
Common air pressure supply (PV) port	1/8" (Rc, NPTF, G)
Common pilot pressure supply (PS) port	M5
Common release pressure supply (PD) port	M5
Common exhaust (EXH.) port	1/2" (Rc, NPTF, G)
Weight (Manifold bases only)	Basic mass for one station is 0.28 kg. Additional mass per one station is 0.12 kg.

- (1) When using 3 or more stations with ZR120□□ manifold, utilize PV port as supply port on both sides.
 (2) When using 3 or more stations with ZR120□□ manifold, utilize EXH port as exhaust port on both sides.

Manifold Air Supply

Supply port location	Manifold Port					
	Left			Right		
	PV	PS	PD	PV	PS	PD
L (Left side)	○	○	○	●	●	●
R (Right side)	●	○	○	○	○	○
B (Both sides)	○	○	○	○	○	○

Air supply to ○ port
 BLANK plug attached to ● port
 Note) BLANK plug is attached on all ports of valve unit.

Individual Spacer

Part no.	Port	Function
ZR1-R1 to R16	PV	Possible to set the air supply pressure individually
	PS	Possible to set the pilot valve air supply pressure individually
	PD	Possible to set the release valve supply pressure individually
	PE	Possible to set the pilot valve exhaust individually

Individual spacer is used when the connecting port of each unit is not common for the manifold connecting port. Mixed specifications of common and individual unit connecting ports for each unit is possible on manifolds with this individual spacer.

How to Order Manifold

<Manifold base>

ZZR1 06 - R

Stations	1
01	1
...	...
06	6

Port location	Right side
R	Right side
L	Left side
B	Both sides

Thread type	
Nil	Rc
F	G (Note 1)
T	NPTF

* Viewed from the front side of valve unit, confirm the port location on the right and/or left side.

Note 1) The thread ridge shape is compatible with the G thread standard (JIS B 0202), but other shapes are not conforming to ISO16030 and ISO1179.

Example 1)

- ZZR106-R 1 pc. (Manifold base only)
- * ZR120S1-K15MZ-EC ... 5 pcs. (Unit)
- * ZR1-BM1 1 pc. (Blank plate)
- * ZR1-R1-3 1 pc. (Individual spacer)

↓ With reference from valve side, the third station from right side

<Function plate>

ZR1 - RV 1 - 1

Piping specifications			
Symbol	Symbol	PV port	PS port
1	PV→PS→PD	Common	Common
2	PV↔PS-PD	Common	Individual

Arrangement (Right valve station which is looked from valve side is first station.)	
1	1 station only
...	...
6	6 stations only
A	All stations

* When the spacers are attached to the specified locations, specify all spacers.

- Example 2) Attached to the first and third stations
 * ZR1-RV1-1
 * ZR1-RV1-3
 Example 3) Attached to all stations.
 * ZR1-RV1-A-3

↑ Fill the number

<Individual spacer>

ZR1 - R1 - 1

R16

Refer to "About individual spacer."

Arrangement (Right valve station which is looked from valve side is first station.)	
1	1 station only
...	...
6	6 stations only
A	All stations

* When the spacers are attached to the specified locations, specify all spacers.
 * When shipping only spacers, specify nothing.

- Example 4) Attached to the first and third stations
 * ZR1-R1-1
 * ZR1-R1-3

⚠ Caution when ordering manifold

The asterisk denotes the symbol for assembly. Prefix it to the ejector part numbers to be mounted.
 When it is not added, the manifold base and ejector are shipped separately.

About individual spacers

- In the right table, ports with the symbol ↓ mean that they are manifold supply, while others are individual supply from the valve unit.
- Symbols in the right table are printed on the surface of individual spacers.

Part no.	Symbol	Part no.	Symbol
ZR1-R1	R1	ZR1-R9	R9 ↓ PV
-R2	R2 ↓ PE	-R10	R10 ↓ PV ↓ PE
-R3	R3 ↓ PD	-R11	R11 ↓ PV ↓ PD
-R4	R4 ↓ PD ↓ PE	-R12	R12 ↓ PV ↓ PD ↓ PE
-R5	R5 ↓ PS	-R13	R13 ↓ PV ↓ PS
-R6	R6 ↓ PS ↓ PE	-R14	R14 ↓ PV ↓ PS ↓ PE
-R7	R7 ↓ PS ↓ PD	-R15	R15 ↓ PV ↓ PS ↓ PD
-R8	R8 ↓ PS ↓ PD ↓ PE	-R16	R16 ↓ PV ↓ PS ↓ PD ↓ PE

<Blanking plate>

ZR1 - BM1

Refer to Example 1).

Manifold/System Circuit Example

When not using individual spacer

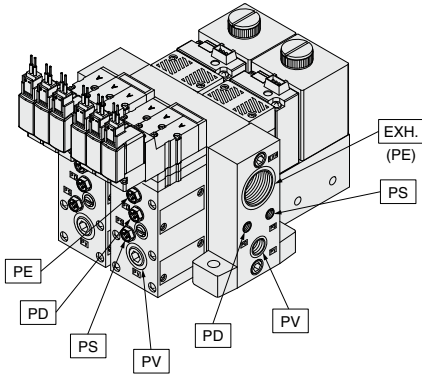

PV: Air pressure supply port
PS: Pilot pressure supply port
PD: Release pressure supply port
PE: Pilot pressure exhaust port
EXH.: Common exhaust port
V: Vacuum Port

<System circuit example>

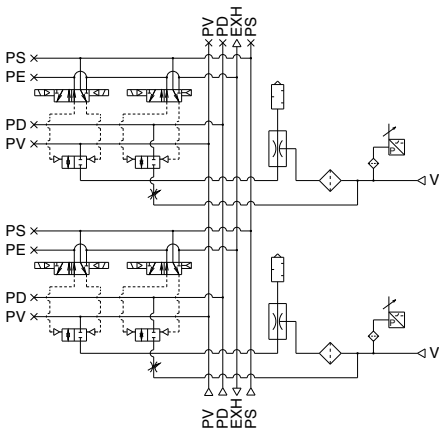

When using individual spacer

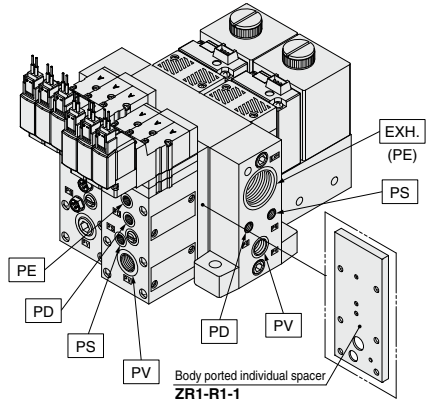

PV: Air pressure supply port
PS: Pilot pressure supply port
PD: Release pressure supply port
PE: Pilot pressure exhaust port
EXH.: Common exhaust port
V: Vacuum Port

<System circuit example>

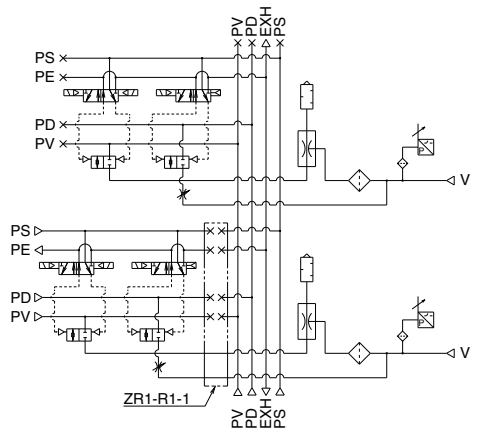

* The common exhaust (EXH.) port is also used as the pilot pressure exhaust (PE) port of the pilot valve. Use while the port is open to the atmosphere.

ZR Series

Ejector System

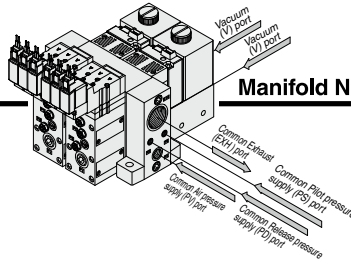

Manifold Nozzle Dia./ $\phi 1.0, \phi 1.3, \phi 1.5$

A: Release flow adjusting needle with lock nut

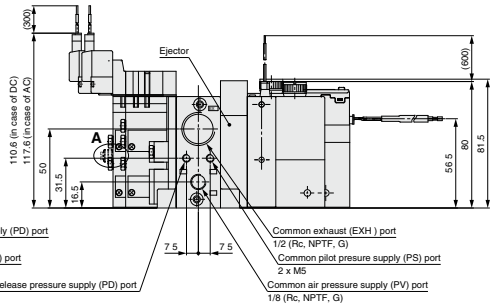
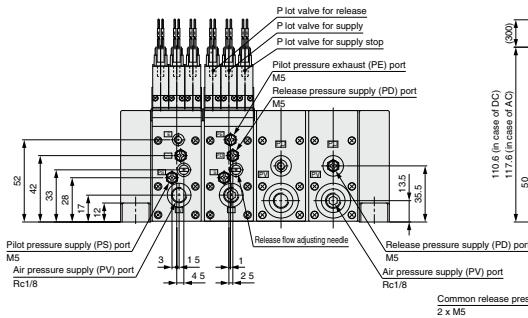
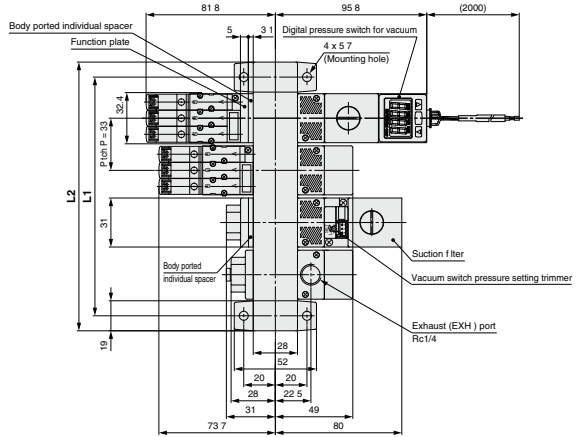
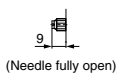

* The common exhaust (EXH.) port is also used as the pilot pressure exhaust (PE) port of the pilot valve. Use while the port is open to the atmosphere.

		(mm)					
Symbol	Stations	1	2	3	4	5	6
L1		52	85	118	151	184	217
L2		71	104	137	170	203	236

Circuit diagram

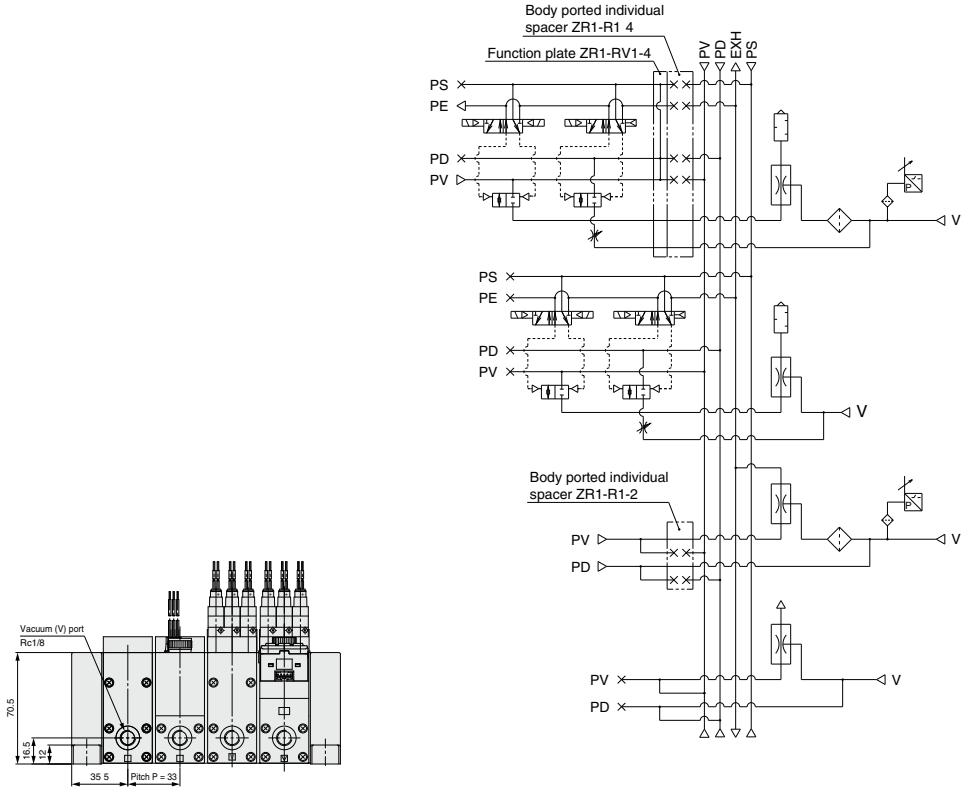

PV: Air pressure supply port
PS: Pilot pressure supply port
PD: Release pressure supply port
PE: Pilot pressure exhaust port
EXH.: Exhaust port
V: Vacuum Port

Ejector System

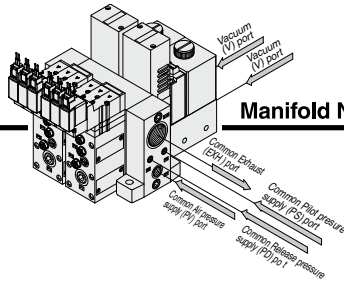

Manifold Nozzle Dia./ø1.8, ø2.0

A: Release flow adjusting needle with lock nut

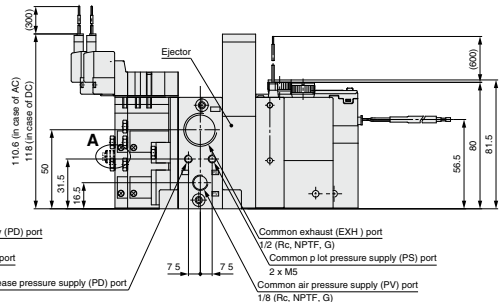
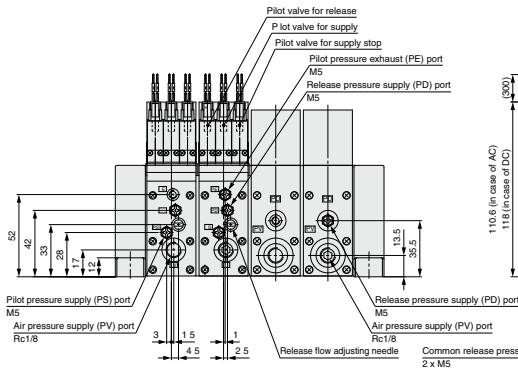
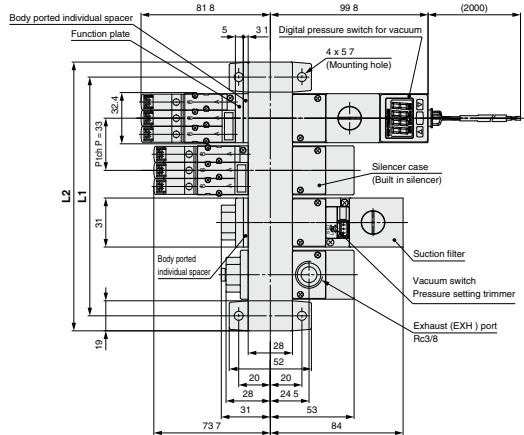
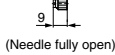

* The common exhaust (EXH.) port is also used as the pilot pressure exhaust (PE) port of the pilot valve. Use while the port is open to the atmosphere.

	(mm)						
Symbol	Stations	1	2	3	4	5	6
L1		52	85	118	151	184	217
L2		71	104	137	170	203	236

Circuit diagram

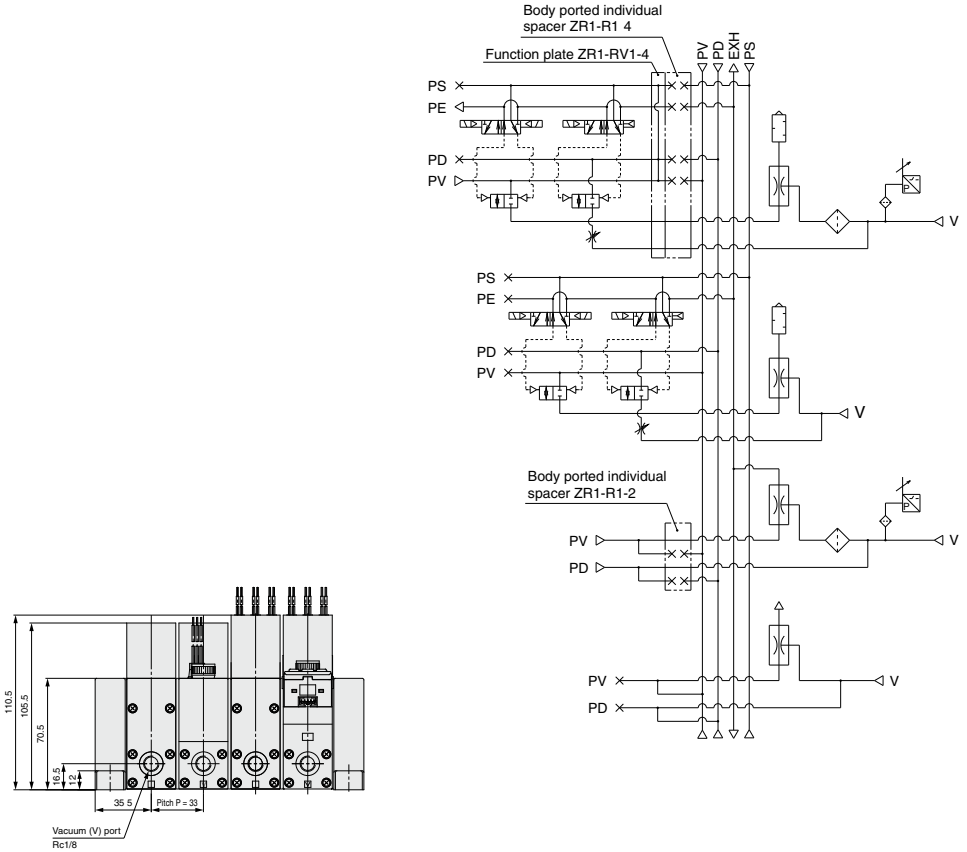

PV: Air pressure supply port
PS: Pilot pressure supply port
PD: Release pressure supply port
PE: Pilot pressure exhaust port
EXH.: Common exhaust port
V: Vacuum Port

Large Size Vacuum Module: Vacuum Pump System



[Option]
Note) CE/UKCA-compliant:
For DC only.

ZR Series

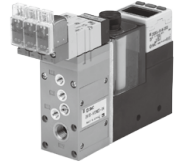

How to Order

Note for model selection
Take function plates into consideration.
(Refer to page 667.)

Components

Valve unit — Pressure switch for vacuum — Suction filter

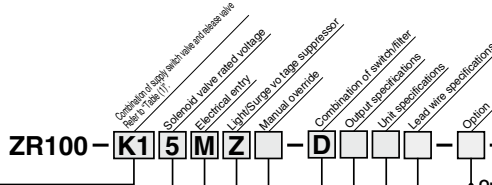

Combination of vacuum valve and release valve
Refer to "Table (1)" in page 665 for details.

Solenoid valve rated voltage	CE/UKCA-compliant
NII (Note)	Air operated —
5	24 VDC ●
6	12 VDC ●
V	6 VDC ●
S	5 VDC ●
R	3 VDC ●
D1 (Note)	100 VAC (50/60Hz) —
D2 (Note)	110 VAC (50/60Hz) —

Note) Air operated, 100 VAC, and 110 VAC type are not CE/UKCA-compliant.

Electrical entry

	Air operated
L	L plug
LN	Lead wire length 0.3 m
LO	Without lead wire
MO	M plug
MN	Lead wire length 0.3 m
MO	Without lead wire
G	Grommet
H	Lead wire length 0.3 m (Applicable to only DC)
	Lead wire length 0.6 m (Applicable to only DC)

• Refer to "Table (2)" on page 665 for part no. of lead wire with connector.

Light/Surge voltage suppressor

NII	None
Z	With light/surge voltage suppressor
S	With surge voltage suppressor

* DC voltage: If the polarity is incorrect at DC (surge voltage suppressor), diode or switching element may be damaged.
AC voltage: S is not available for AC.

Manual override

NII	Non-locking push type
B	Slotted locking type

Combination of switch/filter

D	Digital pressure switch for vacuum (ZSE30A) + Filter
E	Pressure switch for vacuum (ZSE2) + Filter
F	Filter

Output specifications

Digital pressure switch for vacuum (ZSE30A) specifications (D)

N	NPN open collector 1 output
P	PNP open collector 1 output
A	NPN open collector 2 outputs
B	PNP open collector 2 outputs
C	NPN open collector 1 output + Analog voltage output
D	NPN open collector 1 output + Analog current output
E	PNP open collector 1 output + Analog voltage output
F	PNP open collector 1 output + Analog current output

Pressure switch for vacuum (ZSE2) specifications (E)

NII	NPN open collector 1 output
55	PNP open collector 1 output

Filter specifications (F)

NII	No setting
------------	------------

CE/UKCA-compliant

NII	—
Q	CE/UKCA-compliant (DC only)

Option/Shipped separately

	Release flow adjusting needle with lock nut	Bracket (Included)
NII	None	●
L	●	●
M	●	None
N	None	None

Shipped with the manifold assembly

	Release flow adjusting needle with lock nut
NII	None
L	●

Note) Brackets are not shipped together with the manifold assembly.

Lead wire specifications

Digital pressure switch for vacuum (ZSE30A) specifications (D)

NII	Without lead wire
L	Lead wire with connector (Length 2 m)

Refer to "Table (4)" on page 665 for part no. of lead wire with connector.

Pressure switch for vacuum (ZSE2) specifications (E)

NII	Grommet/Lead wire (Length 0.6 m)
L	Grommet/Lead wire (Length 3 m)
C	Lead wire with connector (Length 0.6 m)
CL	Lead wire with connector (Length 3 m)
CN	With connector/Without lead wire

Refer to "Table (3)" on page 665 for part no. of lead wire with connector.

Filter specifications (F)

NII	No setting
------------	------------

Unit specifications

Digital pressure switch for vacuum (ZSE30A) specifications (D)

NII	With unit switching function
M	SI unit only
P	With unit switching function (Initial value psi)

Note 1) This is no longer sold for use in Japan due to the Weight and Measure Act (implemented October, 1999).
Note 2) Fixed unit: kPa

Pressure switch for vacuum (ZSE2) specifications (E)

NII	No setting
------------	------------

Filter specifications (F)

NII	No setting
------------	------------

Table (1) Valve Unit/Combination of Vacuum Switch Valve and Release Valve

Valve unit function			Valve unit components		Symbol	Supply valve			Release valve	
Operation stop	Vacuum adsorption	Vacuum release	Supply valve	Release valve		Solenoid valve		Air operated	Solenoid valve	Air operated
						Double SOL. (SYJ3233-X126)	N.C. (SYJ3133)	(SYJA3130)	N.C. (SYJA3133)	(SYJA3130)
☉	☉	○	Double SOL. (SYJ3233-X126)	N.C. (SYJ3133)	K1	●	—	—	●	—
○	○	○	N.C. (SYJ3133)	N.C. (SYJ3133)	K2	—	●	—	●	—
○	○	○	Air operated (SYJA3130)	Air operated (SYJA3130)	K3	—	—	●	—	●
×	○	○	N.C. (SYJ3133)		C1	—	●	—	(Common with supply valve)	—
×	○	○	Air operated (SYJA3130)		C2	—	—	●	—	(Common with supply valve)
×	○	○	N.O. (SYJ3133)		C3	—	●	—	(Common with supply valve)	—

☉: Possible; ○: Possible with limitations (without sub-including function); ×: Not possible

Table (2) How to Order Valve Plug Connector Assembly

DC	SY100-30-4A	□
For 100 VAC:	SY100-30-1A	□
For 110 VAC:	SY100-30-3A	□

Lead wire length

Nil	300 mm (Standard)
6	600 mm
10	1000 mm
15	1500 mm
20	2000 mm
25	2500 mm
30	3000 mm
50	5000 mm

How to order

When requiring a vacuum unit equipped with valves with lead wires of 600 mm or more, specify the vacuum module valves without the standard connectors and order the required connector ass'ys separately.

Example) ZR100-K15MOZ-EC (-Q) 1 pc.
* SY100-30-4A-6 3 pcs.

Table (3) Pressure Switch for Vacuum/Lead Wire with Connector

ZS-10-5A	□
-----------------	---

Lead wire length

Nil	0.6 m
30	3 m
50	5 m

How to order

When requiring a vacuum switch with a lead wire of 5 m, indicate the part numbers of the vacuum unit switch without a lead wire with connector and the 5 m lead wire connector separately.

Example) ZR100-□□□□□□□□□□(-Q) 1 pc.
* ZS-10-5A-50 1 pc.

Table (4) Digital Pressure Switch for Vacuum/Lead Wire with Connector

ZS-38-3	L
----------------	---

Lead wire core

3	3 cores, 1 output, 2 m (Output specifications: N, P)
4	4 cores, 2 outputs, 2 m (Output specifications: A, B, C, D, E, F)

Vacuum Pump System/Combination of supply valve and release valve

Combination Symbol : K1

Feature : Double solenoid vacuum valve allows for self-holding.

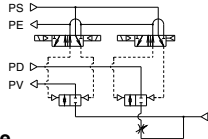

How to Operate

Operation	Pilot valve operation		Note
	Supply valve Pilot valve for supply	Release valve Pilot valve for release	
1. Adsorption	ON	OFF	When power supply is cut off while the supply valve is ON, the operational state is held.
2. Vacuum release	OFF	ON	
3. Operation stop	OFF	OFF	

Combination Symbol : K2

Feature: Single solenoid valve is provided for vacuum valve.

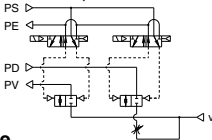

How to Operate

Operation	Pilot valve operation		Note
	Supply valve Pilot valve for supply	Release valve Pilot valve for release	
1. Adsorption	ON	OFF	When power supply is stopped, all operations will be stopped.
2. Vacuum release	OFF	ON	
3. Operation stop	OFF	OFF	

Combination Symbol : K3

Feature: Operation can be controlled by an external pilot valve.

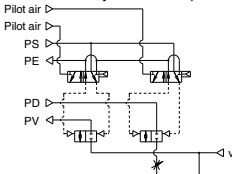

How to Operate

Operation	Pilot valve operation		Note
	Supply valve Air operated a	Release valve Air operated b	
1. Adsorption	ON	OFF	The product is used under the environment in which solenoid valves cannot be used or when the centralized control is applied using external pilot air.
2. Vacuum release	OFF	ON	
3. Operation stop	OFF	OFF	

Combination Symbol : C1

Feature: Adsorption of workpieces (when energized) and release of vacuum (when de-energized) are switched by single solenoid valve.

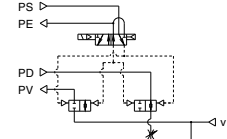

How to Operate

Operation	Pilot valve operation		Note
	Supply valve/Release valve Pilot valve for supply/release		
1. Adsorption	ON		Be careful for blowing off of workpieces or displacement of adsorption position in case of small and/or lightweight workpieces.
2. Vacuum release	OFF		

Combination Symbol : C2

Feature: Adsorption of workpieces and release of vacuum are switched by an external pilot valve.

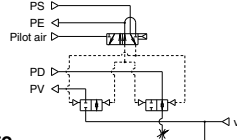

How to Operate

Operation	Pilot valve operation		Note
	Supply valve/Release valve Air operated a		
1. Adsorption	ON		Be careful for blowing off of workpieces or displacement of adsorption position in case of small and/or lightweight workpieces.
2. Vacuum release	OFF		

Combination Symbol : C3

Feature: Adsorption of workpieces (when de-energized) and release of vacuum (when energized) are switched by the single solenoid valve.

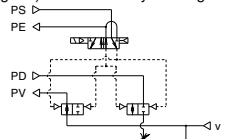

How to Operate

Operation	Pilot valve operation		Note
	Supply valve/Release valve Pilot valve for supply/release		
1. Adsorption	OFF		Be careful for blowing off of workpieces or displacement of adsorption position in case of small and/or lightweight workpieces.
2. Vacuum release	ON		

⚠ Caution

When pipe connection is made to two port connections (PV) port, (PD) port only, use a function plate (ZR1-RV3). Refer to page 667 for further information.

Function Plate : ZR1-RV3

A function plate is used when each connecting port for the valve unit is common. If a function plate is not used (standard), make individual pipe connections to PV, PS, and PD ports respectively.

Without Function Plate (Standard)

Applicable system: Ejector system
External vacuum supply system

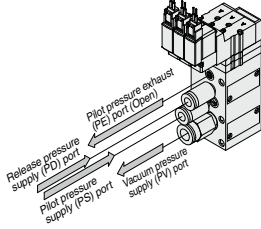

Pipe connection

Example of circuit diagram

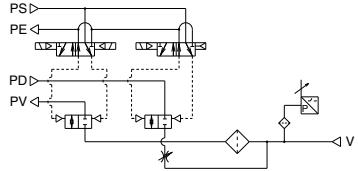

With Function Plate/Applicable to Vacuum Pump System Only

When ZR1-RV3 (PV/PS↔PD) is Selected

Since compressed air is necessary to operate pilot valve in vacuum pump system, supply air to PD port (or PS port).

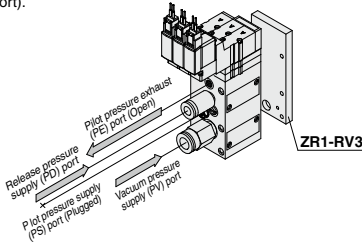

Pipe connection

Example of circuit diagram

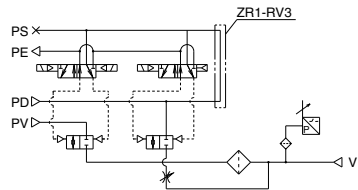

How to Order Function Plate Unit (For Pump System)

ZR1 - RV 3

• Piping specifications

Symbol	Symbol	PV port	PS/PD port
3	PV/PS ↔ PD	Individual	Common

How to order

Indicate the model numbers of the vacuum module and the function plate.

Example) ZR100-K15MZ-E 1
* ZR1-RV3 1

⚠ Caution

Length of assembling mounting threads varies when adding function plate later.
Order from the mounting thread parts list for unit combination on page 679.
Order a plug (ZX1-MP1) separately in order to plug the PD and PS ports that are no longer used due to the addition of function plate.

ZR Series

Valve Unit : ZR1-V□□□□□-□-□



Specifications

Valve unit part no.		ZR1-V□□□□□-□-□	
Components		Supply valve	Release valve
Operating method		Pilot operated	Pilot operated
Combination of supply valve and release valve		Refer to the combination of supply valve and release valve below.	
Supply pressure range of air pressure/vacuum pressure supply (PV) port		-0.1 to 0.6 MPa (PS port pressure or less)	
Supply pressure range of release pressure supply (PD) port		0.05 to 0.6 MPa (PS port pressure or less)	
Supply pressure range of pilot pressure supply (PS) port		0.25 to 0.6 MPa	
Supply pressure range of pilot pressure supply (PA, PB) ports for supply and release <small>Note</small>		PS port pressure to 0.6 MPa	
Main valve effective area (mm²)		8.2	0.96
Main valve effective area (Cv)		0.45	0.053
Maximum operating frequency		5 Hz	
Operating temperature range		5 to 50°C	
Standard		Bracket B (ZR1-0BB)	

Note) Combination of supply valve and release valve: K3, C2

The supply and release valves of this product have a structure which uses the pressure of the pilot pressure supply (PS) port to operate them. Be sure to supply a pressure that is the pressure of the pilot pressure supply (PS) port or more and 0.6 MPa or less to the pilot pressure supply (PA, PB) ports for supply and release.

Solenoid Valve/Specifications

Solenoid valve		SYJ3133-□□□□, SYJ3233-□□□□-X126	
Rated voltage V	DC	24, 12, 6, 5, 3	
	AC 50/60 Hz	100, 110	
Allowable voltage range		Rated voltage ±10%	
Power consumption W	DC	0.35 (With indicator light: 0.4)	
	AC	100 V	0.78 (With indicator light: 0.81)
Apparent power VA	AC	110 V	0.86 (With indicator light: 0.89)
	Electrical entry		L/M plug connector, Grommet
Light/Surge voltage suppressor		Available, Not available (at grommet)	
Manual operation		Non-locking push type, Locking slotted type	

Combination of Supply Valve and Release Valve

Combination symbol	Vacuum switch valve	Release valve	Weight (kg)
K1	Double SOL. (SYJ3233-X126)	N.C. (SYJ3133)	0.34
K2	N.C. (SYJ3133)	N.C. (SYJ3133)	0.27
K3	Air operated (SYJA3130)	Air operated (SYJA3130)	0.194
C1		N.C. (SYJ3133)	0.22
C2		Air operated (SYJA3130)	0.174
C3		N.C. (SYJ3133)	0.21

* Weight includes Bracket B. (Solenoid valve: 24 VDC, M plug connector type)

How to Order

Refer to page 664 for further part no. information.

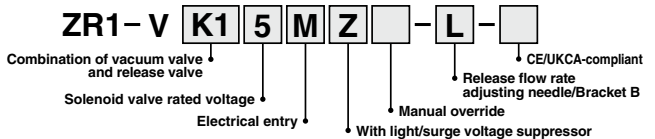

Vacuum Pressure Switch Unit/Digital Pressure Switch for Vacuum : ZR1-ZSE30A-00-□-□□



Specifications

Rated pressure range	0.0 to -101.0 kPa
Set pressure range	10.0 to -105.0 kPa
Withstand pressure	500 kPa
Applicable fluid	Air
Power supply voltage	12 to 24 VDC ±10% (with power supply polarity protection)
Current consumption	40 mA (at no load)
Switch output	NPN or PNP open collector 1 output NPN or PNP open collector 2 outputs (selectable)
Hysteresis mode	Variable (0 to variable)
Window comparator mode	Variable (0 to variable)
Display	4-digit, 7-segment, 2-color LCD (Red/Green) Sampling cycle: 5 times/sec.
Display accuracy	±2% F.S. ±1 digit (Ambient temperature of 25°C)
Enclosure	IP40
Operating temperature range	Operating: 0 to 50°C, Stored: -10 to 60°C (No freezing or condensation)
Operating humidity range	Operating/Stored: 35 to 85% RH (No condensation)
Withstand voltage	1000 VAC for 1 minute between terminals and housing
Temperature characteristics	±2% F.S. (Based on 25°C)

Note 1) When analog voltage output is selected, analog current output cannot be used together.
 Note 2) When analog current output is selected, analog voltage output cannot be used together.
 Note 3) If the applied pressure fluctuates around the set value, the hysteresis must be set to a value more than the fluctuating width, otherwise, chattering will occur.

Refer to page 648 for further specifications.

Vacuum Pressure Switch : ZSE2-0R-□□

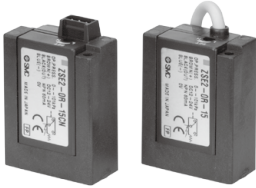

Refer to page 645 for further specifications.

Specifications

Pressure switch for vacuum part no.	ZSE2-0R-15□	ZSE2-0R-55□
Fluid	Air	
Rated pressure range/Set pressure range	0 to -101 kPa	
Proof pressure	500 kPa	
Hysteresis	3% F.S. or less (Fixed)	
Temperature characteristics (Based on 25°C)	± 3% F.S. or less	
Operating voltage	12 to 24 VDC (Ripple ±10% or less)	
Output	NPN Open collector 30 V, 80 mA	PNP Open collector 80 mA
Indicator light	Lights up when ON	
Current consumption	17 mA or less (when 24 VDC is ON)	
Proof pressure (Max. operating pressure)	0.5 MPa*	
Operating temperature range	5 to 50°C	

* When using the ejector system, instantaneous pressure up to 0.5 MPa will not damage the switch.

Note) Operation outside of the maximum operating pressure and operating temperature range may cause a serious accident or damage.

Pressure Switch for Vacuum/Suction Filter Unit : ZR1-F□□□□ - □

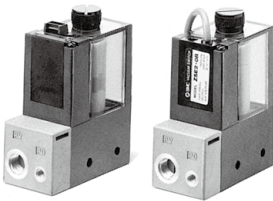

Refer to page 649 for further specifications.

Specifications

Unit no.		ZR1-F□□□□ - □
Suction filter	Rated pressure range/Set pressure range	-100 to 0.5 MPa
	Operating temperature range	5 to 50°C
	Filtration degree	30 μm
Filtration material		PVA sponge
Pressure switch for vacuum		Refer to pages 645 and 648 regarding pressure switch for vacuum.

Note) Operation outside of the operating pressure and operating temperature rangemay cause a serious accident or damage.

Filter case

⚠ Caution

- ① The case is made of polycarbonate. Therefore, do not use it with or expose it to the following chemicals: paint thinner, carbon tetrachloride, chloroform, acetic ester, aniline, cyclohexane, trichloroethylene, sulfuric acid, lactic acid, watersoluble cutting oil (alkalinic), etc.
- ② Do not expose it to direct sunlight.

Suction Filter : ZR1-FX-□



Refer to page 651 for further specifications.

Specifications

Model		ZR1-FX-□
Operating pressure range		-0.1 to 0.5 MPa
Operating temperature range		5 to 50°C
Filtration efficiency		30 μm
Filter media		PVA sponge
Weight (with bracket)		0.1 kg

Note) Operation outside of the operating pressure and operating temperature rangemay cause a serious accident or damage.

Filter case

⚠ Caution

- ① The case is made of polycarbonate. Therefore, do not contact it or expose it to the following chemicals: paint thinner, carbon tetrachloride, chloroform, acetic ester, aniline, cyclohexane, trichloroethylene, sulfuric acid, lactic acid, watersoluble cutting oil (alkalinic), etc.
- ② Do not expose it to direct sunlight.

Construction

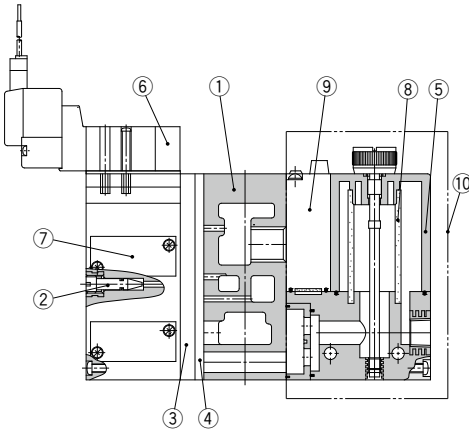

Components Parts

No.	Description	Material	Part model
①	Manifold base	Aluminum alloy	
②	Release flow rate adjusting needle	Stainless steel	Refer to ZR1-NA ^{Note 2)}
③	Function plate	PBT	Refer to page 674.
④	Individual spacer	PBT	Refer to page 674.
⑤ ⁽¹⁾	Filter case	Polycarbonate	Refer to page 649.
⑥	Pilot valve assembly	—	Refer to Table (1)
⑦	Valve body assembly	—	Refer to Table (2)
⑧	Filter element	PVA sponge	ZR1-FZ (30 μm)
⑨	Pressure switch for vacuum	—	ZSE2-OR- ¹⁵ / ₃₅ -□
⑩	Filter switch unit for replacement	—	ZR1-F□□□□-D

Note 1) Precautions on handling the filter case

- The case is made of polycarbonate. Therefore, do not contact it or expose it to the following chemicals: paint thinner, carbon tetrachloride, chloroform, acetic ester, aniline, cyclohexane, trichloroethylene, sulfuric acid, lactic acid, water soluble cutting oil (alkalino), etc.
- Do not expose it to direct sunlight.

Note 2) Turning the release flow rate adjusting needle 2 full turns from the fully closed position renders the needle valve fully open. Do not turn more than two times since turning excessively may cause the needle fall off. In order to prevent the needle from loosening and falling out, a release flow rate adjusting needle (ZR1-ND-L) with lock nut is available.

Table (1) How to Order Pilot Valves

Symbol	Components		Model
	Supply valve	Release valve	
K1	Double solenoid valve N.C. (SYJ3233)	Single solenoid valve N.C. (SYJ3133)	Refer to "How to Order" below. Supply: ZR1-SYJ3233-□□□□-X126 Release: ZR1-SYJ3133-□□□□
	Air operated N.C. (SYJA3130)	Air operated N.C. (SYJA3130)	

Table (2) How to Order Valve Body Assembly

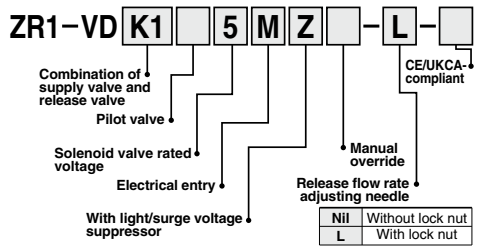

Refer to page 664 for further symbol specifications.
Bracket is not included.

Table (3) Pressure Switch for Vacuum + Suction Filter Unit

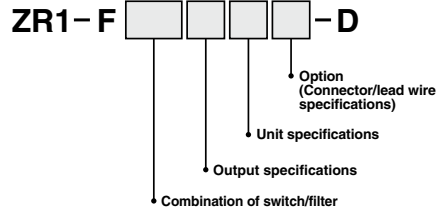

Refer to page 649 for further symbol specifications.
Bracket is not included.

How to Order Solenoid Valves/Air Operated Valves

Air operated

SYJA3130

Solenoid valve

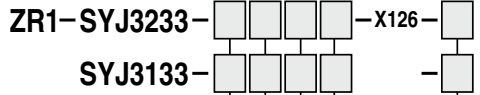

Symbol	rated voltage
5	24 VDC
6	12 VDC
V	6 VDC
S	5 VDC
R	3 VDC
1	100 VAC (50/60Hz)
3	110 VAC (50/60Hz)

Symbol	CE/UKCA-compliant
Nll	Standard
Q	CE/UKCA-compliant (DC only)

Symbol	Manual override
Nll	Non-locking push type
D	Slotted locking type

Symbol	Electrical entry	Light/Surge voltage suppressor
L	L plug connector type	Nll None
LN	Without lead wires	
LO	Without connector	Z With light and surge voltage suppressor
M	M plug connector type	
MN	Without lead wires	S With surge voltage suppressor (DC only)
MO	Without connector	
G	Without lead wires	
M	Lead wire: 0.3 m	
H	Grommet type	
H	Lead wire: 0.6 m	

(Note) Mounting screw and pilot valve gasket are included.

Large Size Vacuum Module: Vacuum Pump System **ZR Series**

Complete Unit

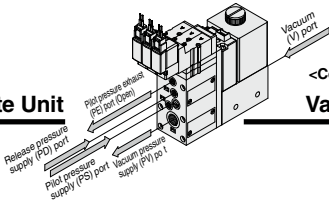

<Components>

Valve + Pressure Switch for Vacuum + Filter Unit

Circuit diagram

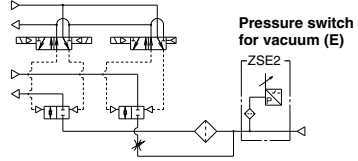

Type K1

Vacuum valve: Double SOL.

Release valve: Single SOL. (N.C.)

ZR100-K1□M□□-E□□-□-□

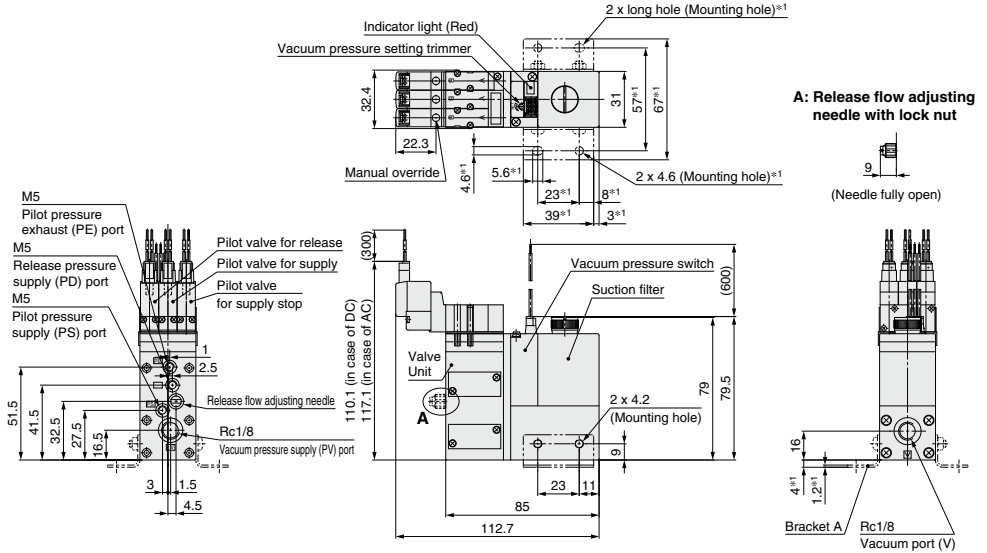

ZR100-K1□M□□-D□□□-□-□

Digital pressure switch for vacuum (D)

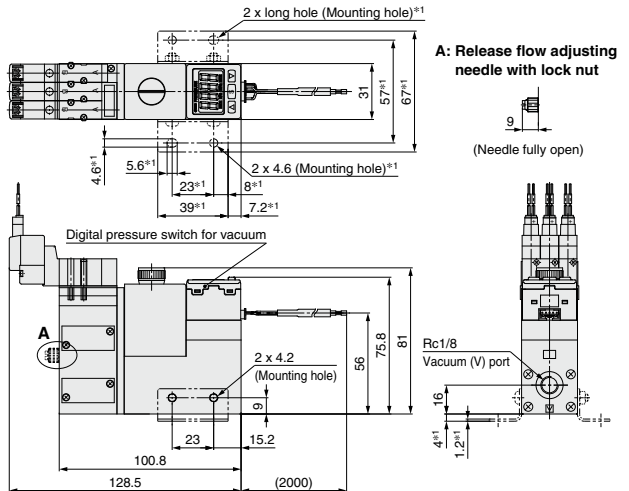
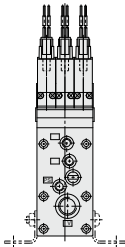
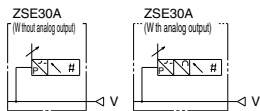

Note) Dimensions marked with "±1" are those after the bracket A is mounted.
Bracket A part no.: ZR1-0BA

ZR Series

Vacuum Pump System

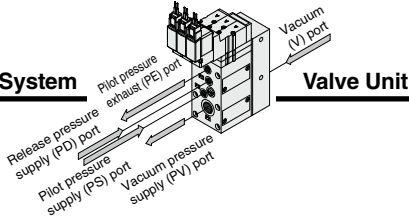

Type K1

ZR1-VK1□M□□-□-□

Circuit diagram

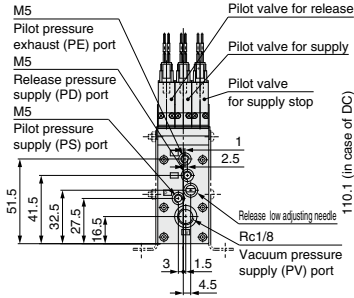
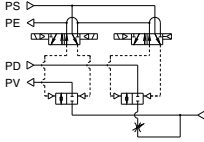

A: Release flow adjusting needle with lock nut

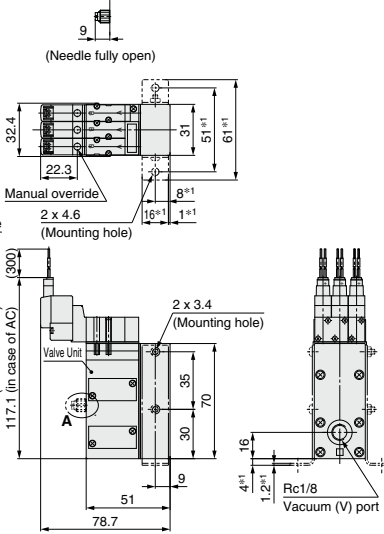

Type K2

ZR1-VK2□M□□-□-□

Circuit diagram

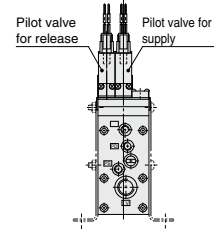
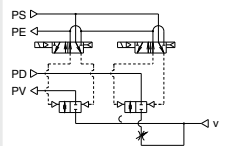

Note) Dimensions marked with "※1" are those after the bracket B is mounted.
Bracket B part no.: ZR1-0BB

Type K3

ZR1-VK3-□

Circuit diagram

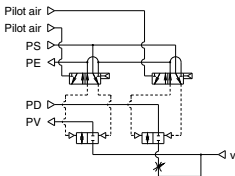

A: Release flow adjusting needle with lock nut

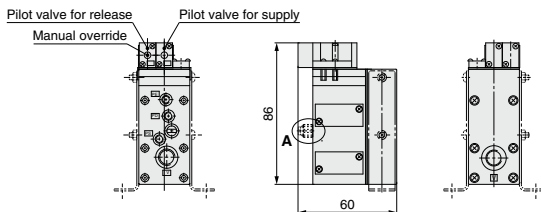
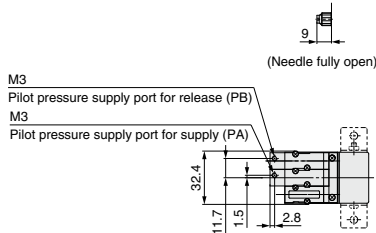

★ Dimensions not indicated are identical to type K2.

Vacuum Pump System

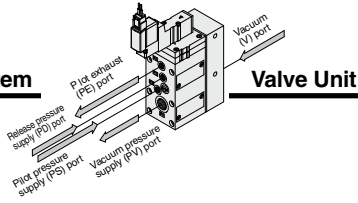

Type C1

ZR1-VC1□M□□-□-□

Circuit diagram

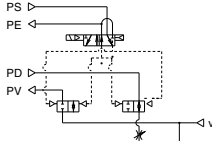

A: Release flow adjusting needle with lock nut

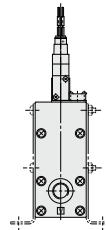
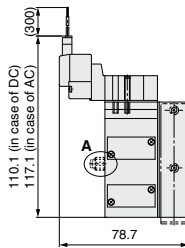
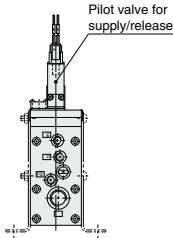
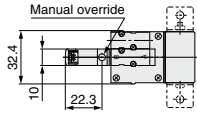
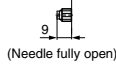

Type C3

ZR1-VC3□M□□-□-□

Circuit diagram

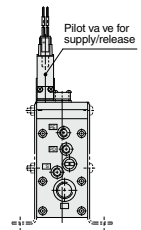
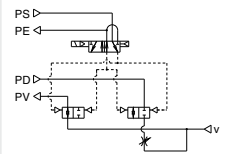

Note) Dimensions marked with "φ" are those after the bracket B is mounted.
Bracket B part no.: ZR1-0BB

Type C2

ZR1-VC2-□

Circuit diagram

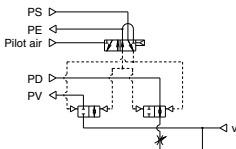

A: Release flow adjusting needle with lock nut

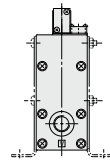
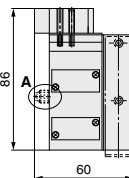
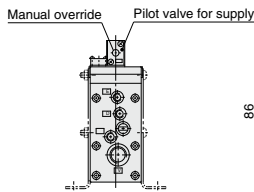
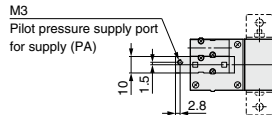

★ Dimensions not indicated are identical to the drawings above.

Manifold Specifications/Vacuum Pump System



Specifications

Max. number of units	6 stations
Port	Port size
Common vacuum pressure supply (PV) port	1/8 (Rc, NPTF, G)
Common pilot pressure supply (PS) port	M5
Common release pressure supply (PD) port	M5
Common exhaust (EXH) port	1/2 (Rc, NPTF, G)
Weight (Manifold bases only)	Basic mass for one station is 0.28kg. Additional mass per one station is 0.12 kg.

Note) When using 3 or more stations with ZR100 manifold, utilize PV port as suction on both sides.

Manifold Vacuum/Air Supply

Supply port location	Manifold		Left			Right		
	Port	Port	PV	PS	PD	PV	PS	PD
L (Left side)	○	○	○	○	○	●	●	●
R (Right side)	●	●	●	●	●	○	○	○
B (Both sides)	○	○	○	○	○	○	○	○

Vacuum supply to ○ PV port.

Air supply to ○ port.

BLANK plug attached to ● port.

Note) BLANK plug is attached on all ports of valve unit.

Individual Spacer

Part no.	Port	Function
ZR1-R1 to R16	PV	Possible to set the external vacuum pressure individually
	PS	Possible to set the pilot valve air supply pressure individually
	PD	Possible to set the release valve supply pressure individually
	PE	Possible to set the pilot valve exhaust individually

Individual spacer is used when the connecting port of each unit is not common for the manifold connecting port. Mixed specifications of common and individual unit connecting ports for each unit is possible on manifolds with this individual spacer.

How to Order Manifold

<Manifold base>

ZZR1 06 - [] []

Stations	1
01	1
⋮	⋮
06	6

Port location	R	Right side
	L	Left side
	B	Both sides

Thread type	
Nll	Rc
F	G (Note)
T	NPTF

* Viewed from the front side of valve unit, confirm the port location on the right and/or left side.

Note) The thread ridge shape is compatible with the G thread standard (JIS B 0202), but other shapes are not conforming to ISO16030 and ISO1179.

Example 1)

- *ZZR106-R 1 pc. (Manifold base only)
- *ZR100-K15MZ-EC 5 pcs. (Unit)
- *ZR1-BM1 1 pc. (Blank plate)
- *ZR1-R1-3 1 pc. (Individual spacer)

● With reference from valve side, the third station from right side

⚠ Caution when ordering manifold

The asterisk denotes the symbol for assembly. Prefix it to the ejector part numbers to be mounted.

When it is not added, the manifold base and pump system are shipped separately.

<Function plate>

ZR1 - RV3 - [1]

Arrangement (Right valve station which is looked from valve side is first station.)

1	1 station only
⋮	⋮
6	6 stations only
A	All stations

* When the spacers are attached to the specified locations, specify all spacers.

Example 2) Attached to the first and third stations

- *ZR1-RV3-1
- *ZR1-RV3-3

Example 3) Attached to all stations.

- *ZR1-RV3-A...2

Fill the number

<Individual spacer>

ZR1 - R1 - [1]

R16

Refer to (About individual spacer.)

Arrangement	1	1 station only
	⋮	⋮
	6	6 stations only
	A	All stations

* When the spacers are attached to the specified locations, specify all spacers.

* When shipping only spacers, specify nothing.

Example 4) Attached to the first and third stations

- *ZR1-R1-1
- *ZR1-R1-3

<Blanking plate>

ZR1 - BM1

Refer to Example 1).

About individual spacers

- Manifold supply or valve unit supply can be selectable for each port. In the right table, ports with the symbol \uparrow mean that they are manifold supply, while others are individual supply from the valve unit.
- Symbols in the right table are printed on the surface of individual spacers.

Part no.	Symbol	Part no.	Symbol
ZR1-R1	R1	ZR1-R9	R9 \uparrow PV
-R2	R2 \uparrow PE	-R10	R10 \uparrow PV \uparrow PE
-R3	R3 \uparrow PD	-R11	R11 \uparrow PV \uparrow PD
-R4	R4 \uparrow PD \uparrow PE	-R12	R12 \uparrow PV \uparrow PD \uparrow PE
-R5	R5 \uparrow PS	-R13	R13 \uparrow PV \uparrow PS
-R6	R6 \uparrow PS \uparrow PE	-R14	R14 \uparrow PV \uparrow PS \uparrow PE
-R7	R7 \uparrow PS \uparrow PD	-R15	R15 \uparrow PV \uparrow PS \uparrow PD
-R8	R8 \uparrow PS \uparrow PD \uparrow PE	-R16	R16 \uparrow PV \uparrow PS \uparrow PD \uparrow PE

Manifold/System Circuit Example

When not using individual spacer

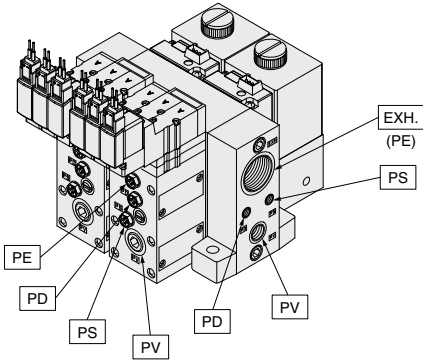

PV: Vacuum pressure supply port
PS: Pilot pressure supply port
PD: Release pressure supply port
PE: Pilot pressure exhaust port
EXH.: Common exhaust port
V: Vacuum Port

When using individual spacer

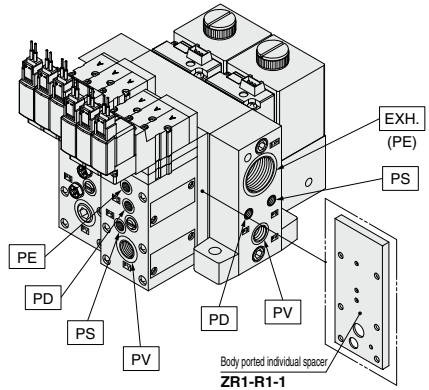

PV: Vacuum pressure supply port
PS: Pilot pressure supply port
PD: Release pressure supply port
PE: Pilot pressure exhaust port
EXH.: Common exhaust port
V: Vacuum Port

<System circuit example>

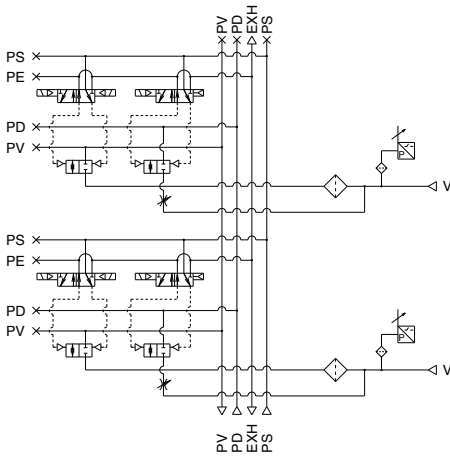

<System circuit example>

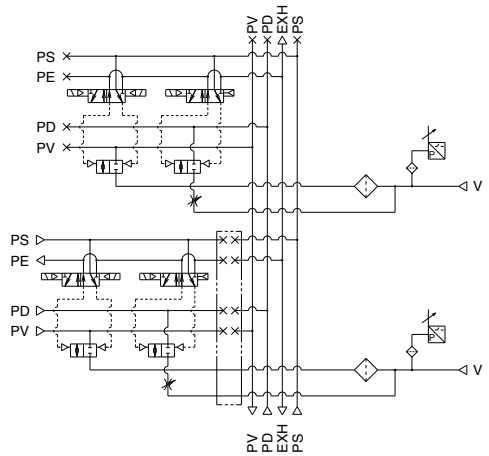

* The pilot exhaust air from the pilot valve is exhausted from the common exhaust (EXH.) port. Use with the port open to the atmosphere.

ZR Series

Vacuum Pump System

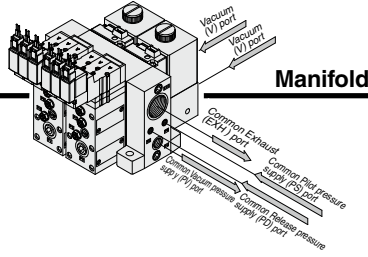

A: Release flow adjusting needle with lock nut

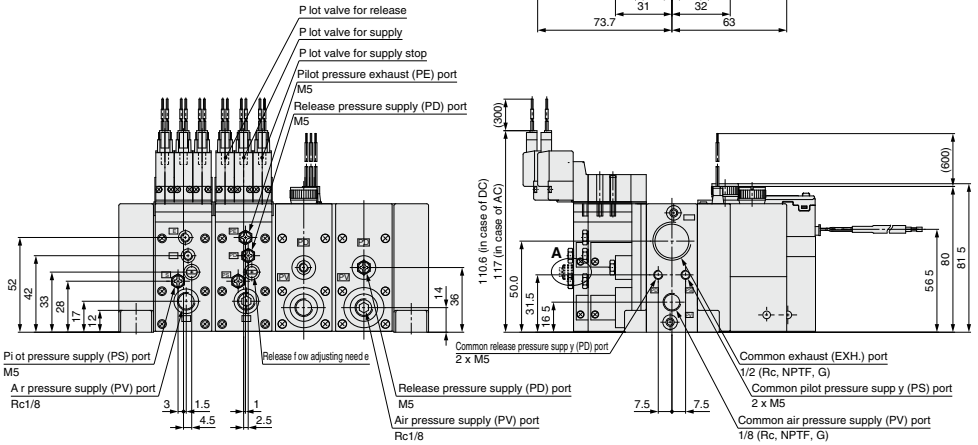
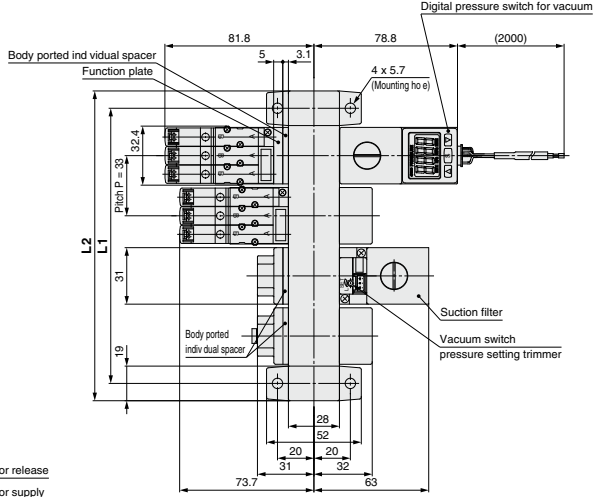
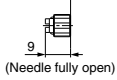

* The pilot exhaust air from the pilot valve is exhausted from the common exhaust (EXH.) port. Use with the port open to the atmosphere.

		(mm)					
Symbol	Stations	1	2	3	4	5	6
L1		52	85	118	151	184	217
L2		71	104	137	170	203	236

Circuit diagram

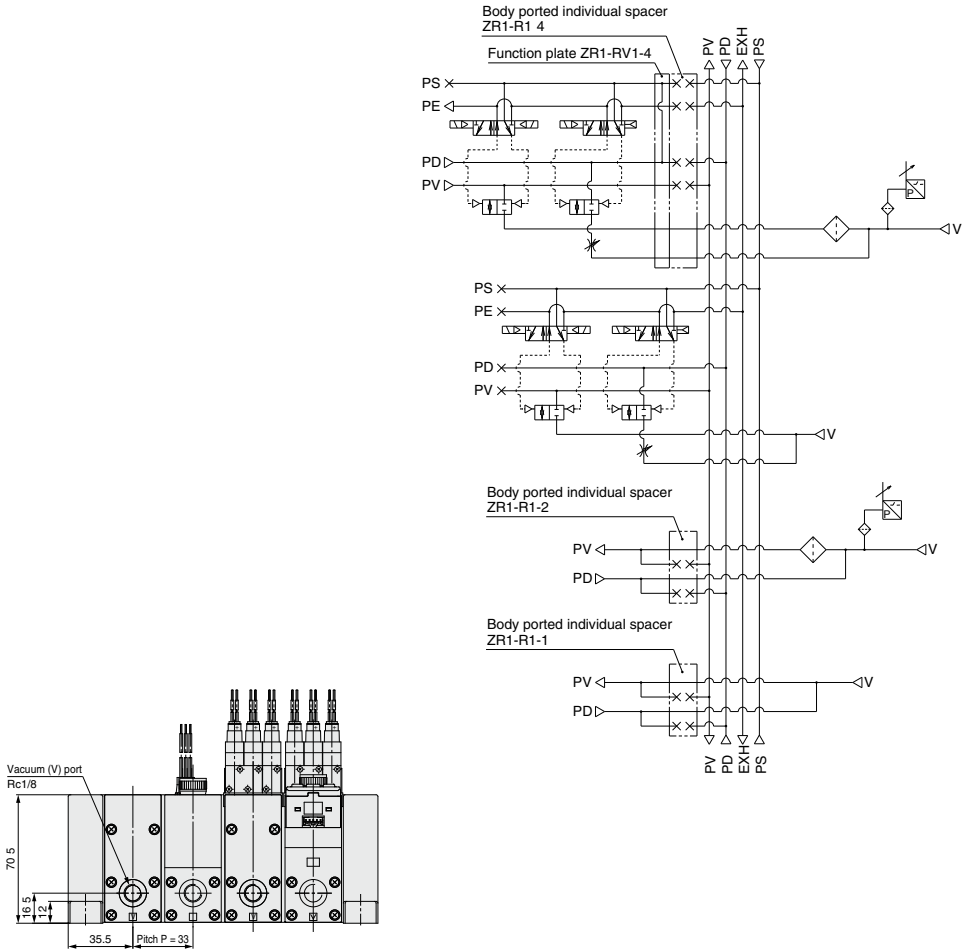

PV : Vacuum pressure supply port
PS : Common pilot pressure supply port
PD : Common release pressure supply port
PE : Pilot valve exhaust port
EXH : Common exhaust port
V : Vacuum Port

Ejector System

Mounting Thread Parts List for Unit Combination

Manifold Specifications	Without Manifold
Components	Valve unit + Ejector unit + Pressure switch for vacuum/Filter unit

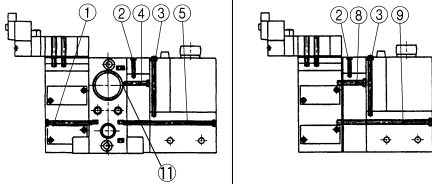

Components	Valve unit + Ejector unit
------------	---------------------------

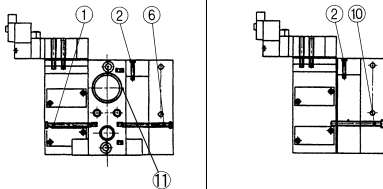

Components	Ejector unit + Pressure switch for vacuum/Filter unit
------------	---

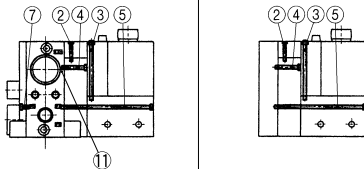

Components	Ejector unit
------------	--------------

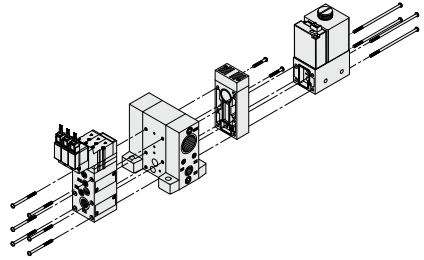
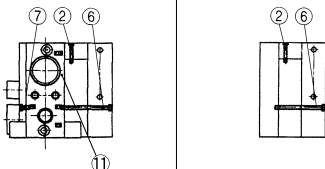

Mounting Thread Parts List for Unit Combination

No.	Combination specifications	Assembly part number
1	Standard (without options)	ZR1-SR2-33-A(a set of six threads)
	With individual spacer	ZR1-SR2-37-A(a set of six threads)
	With function plate	ZR1-SR2-39-A(a set of six threads)
	With individual spacer + with function plate	ZR1-SR2-41-A(a set of six threads)
2	Individual, common and port exhaust type for nozzle size 10, 13	ZR1-SR1-13-A(a set of two threads)
	Common and port exhaust type for nozzle size 15	ZR1-SR1-23-A(a set of two threads)
	Common and port exhaust type for nozzle size 18, 20	ZR1-SR1-53-A(a set of two threads)
3	For vacuum switch and adapter A	ZR1-SR2-41-1A(a set of two threads)
	For nozzle size 10, 13, 15	ZR1-SR2-17-A(a set of two threads)
4	For nozzle size 18, 20	ZR1-SR2-21-A(a set of two threads)
	For nozzle size 10, 13, 15	ZR1-SR2-66-A(a set of four threads)
5	For nozzle size 18, 20	ZR1-SR2-70-A(a set of four threads)
	For nozzle size 10, 13, 15 [For ZSE30A spec.]	ZR1-SR2-82-A(a set of four threads)
6	For nozzle size 18, 20 [For ZSE30A spec.]	ZR1-SR2-86-A(a set of four threads)
	For nozzle size 10, 13, 15	ZR1-SR2-35-A(a set of six threads)
7	For nozzle size 18, 20	ZR1-SR2-39-A(a set of six threads)
	Standard (without options)	ZR1-SR2-5-A(a set of six threads)
8	With individual spacer	ZR1-SR2-8-A(a set of six threads)
	For nozzle size 10, 13, 15	ZR1-SR3-19-1A(a set of two threads)
	For nozzle size 18, 20	ZR1-SR3-23-A(a set of two threads)
	For nozzle size 10, 13, 15 + with function plate	ZR1-SR3-24-1A(a set of two threads)
9	For nozzle size 18, 20 + with function plate	ZR1-SR3-28-A(a set of two threads)
	For nozzle size 10, 13, 15	ZR1-SR3-68-A(a set of four threads)
	For nozzle size 18, 20	ZR1-SR3-72-A(a set of four threads)
	For nozzle size 10, 13, 15 + with function plate	ZR1-SR3-73-A(a set of four threads)
	For nozzle size 18, 20 + with function plate	ZR1-SR3-77-A(a set of four threads)
	For nozzle size 10, 13, 15 [For ZSE30A spec.]	ZR1-SR3-84-A(a set of four threads)
	For nozzle size 18, 20 [For ZSE30A spec.]	ZR1-SR3-88-A(a set of four threads)
For nozzle size 10, 13, 15 + with function plate [For ZSE30A spec.]	ZR1-SR3-89-A(a set of four threads)	
10	For nozzle size 18, 20 + with function plate [For ZSE30A spec.]	ZR1-SR3-93-A(a set of four threads)
	For nozzle size 10, 13, 15	ZR1-SR3-37-A(a set of six threads)
	For nozzle size 18, 20	ZR1-SR3-41-A(a set of six threads)
	For nozzle size 10, 13, 15 + with function plate	ZR1-SR3-42-A(a set of six threads)
11	For nozzle size 18, 20 + with function plate	ZR1-SR3-46-A(a set of six threads)
	When the ejector is compatible with silencer exhaust or port exhaust	BA00601(M12 x 12)
	When the ejector is compatible with common exhaust	Unnecessary

Note 1) • BA00601 (M12 x 12 screws/Hexagon socket head set screws) in until the head aligns with the manifold base surface.

- The manifold base not assembled with the unit does not include BA00601. Please order them separately.

Note 2) When the valve unit is assembled from a single unit function to a manifold function, 3 pcs. of ZX1-MP1 for PS, PD, PE ports and 1 pc. of TB00148 for PV port are required.

⚠ Precautions

- Be sure to read this before handling the products.
- Refer to page 33 for safety instructions and pages 34 to 36 for vacuum equipment precautions.

⚠ Caution

Refer to the Vacuum Equipment Model Selection on page 11 for precautions on matching with vacuum circuit.

Vacuum Pump System

Mounting Thread Parts List for Unit Combination

Manifold Specifications	Without Manifold
-------------------------	------------------

Components	Valve unit + Pressure switch for vacuum / Filter unit
------------	---

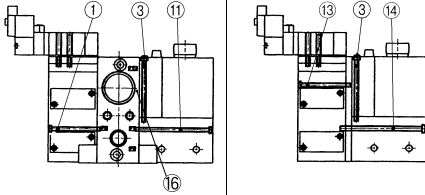

Components	Valve unit
------------	------------

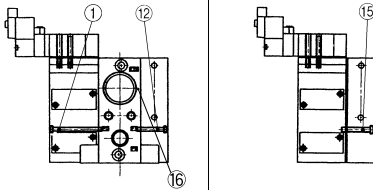

Components	Pressure switch for vacuum / Filter unit
------------	--

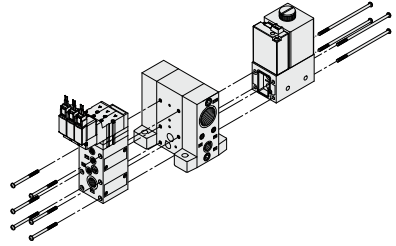
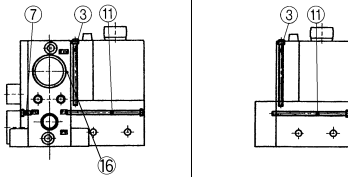

Mounting Thread Parts List for Unit Combination

No.	Combination specifications	Assembly part number
1	Standard (Without options)	ZR1-SR2-33-A(a set of six threads)
	With individual spacer	ZR1-SR2-37-A(a set of six threads)
	With function plate	ZR1-SR2-39-A(a set of six threads)
3	With individual spacer + with function plate	ZR1-SR2-41-A(a set of six threads)
	For vacuum switch and adapter A	ZR1-SR2-41-1A(a set of two threads)
7	Standard (Without options)	ZR1-SR2-5-A(a set of six threads)
	With individual spacer	ZR1-SR2-9-A(a set of six threads)
11	Standard (Without options)	ZR1-SR2-49-A(a set of four threads)
	Standard (Without options) [For ZSE30A spec.]	ZR1-SR2-66-A(a set of four threads)
12	Standard (Without options)	ZR1-SR2-18-A(a set of six threads)
	Standard (Without options)	ZR1-SR2-33-1A(a set of two threads)
13	With function plate	ZR1-SR2-39-1A(a set of two threads)
	Standard (Without options)	ZR1-SR3-54-A(a set of four threads)
	With function plate	ZR1-SR3-59-A(a set of four threads)
14	Standard (Without options) [For ZSE30A spec.]	ZR1-SR3-70-A(a set of four threads)
	With function plate [For ZSE30A spec.]	ZR1-SR3-75-A(a set of four threads)
	Standard (Without options)	ZR1-SR3-19-A(a set of six threads)
15	With function plate	ZR1-SR3-24-A(a set of six threads)
	Standard	BA00601(M12 x 12)

Note 1) • BA00601 (M12 x 12 screws/Hexagon socket head set screws) in until the head aligns with the manifold base surface.

• The manifold base not assembled with the unit does not include BA00601. Please order them separately.

Note 2) When the valve unit is assembled from a single unit function to a manifold function, 3 pcs. of ZX1-MP1 for PS, PD, PE ports and 1 pc. of TB00148 for PV port are required.



ZR Series

Specific Product Precautions

Be sure to read this before handling the products.

Refer to page 33 for safety instructions and pages 34 to 36 for vacuum equipment precautions.

Vacuum Switch

Warning

- The following diagram shows the internal circuits of the vacuum switch as well as wiring examples. Incorrect wiring could cause malfunction or failure, leading to an electric shock or fire.

For Vacuum pressure switch (ZSE2)

NPN open collector (1 output)

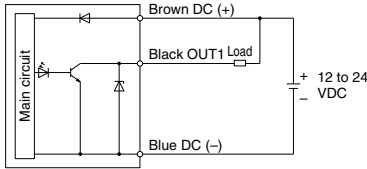

PNP open collector (1 output)

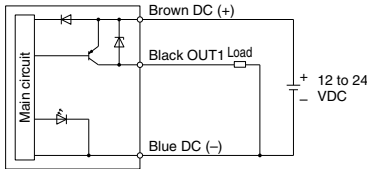

For Digital pressure switch for vacuum (ZSE30A)

N

NPN open collector (1 output)

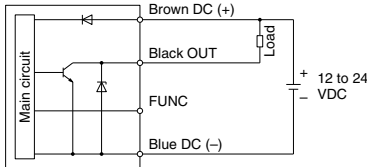

P

PNP open collector (1 output)

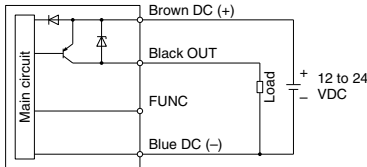

A

NPN open collector (2 outputs)

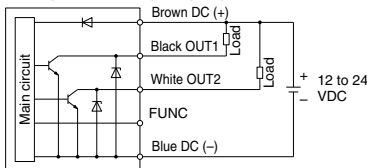

B PNP open collector (2 outputs)

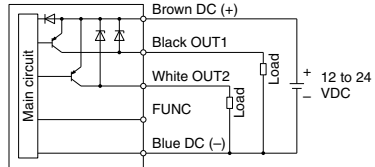

C NPN open collector (1 output) + Analog voltage output

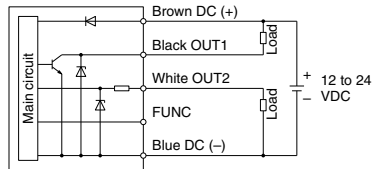

D NPN open collector (1 output) + Analog current output

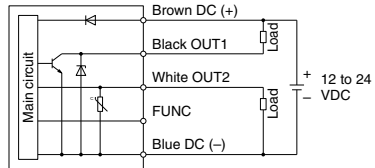

E PNP open collector (1 output) + Analog voltage output

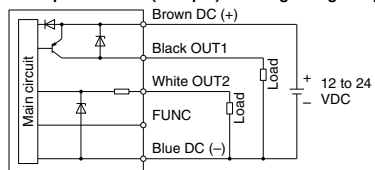

F PNP open collector (1 output) + Analog current output

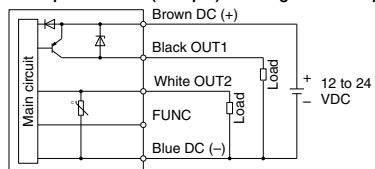

* The FUNC terminal is connected when using the copy function. (Refer to the operation manual of the ZSE30A series.)