

Rotary Actuated Air Gripper

MHR2, MDHR2/MHR3, MDHR3

2-finger type: Size 10, 15, 20, 30/ 3-finger type: Size 10, 15

High Precision - Repeatability ± 0.01 mm

Parallel opening and closing mechanism utilizing a cross roller guide produces smooth operation without play, with high precision and long life.

Low Profile

Using rotary actuators in the part of actuating portion enables a design compact.

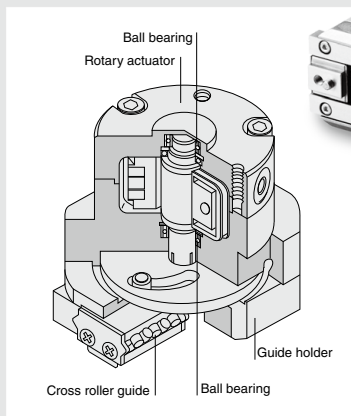

Universal mounting

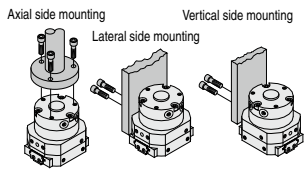

MDHR2

MDHR3



- Possible to mount solid state switch with indicator light D-M9. Easy to locate switch to optimum set point.

High rigidity

Fingers operate smoothly as the holder maintains the guide from the outside and prevents finger displacement.



Applicable for Clean Series.

Refer to the [Web Catalog](#) for details.

Internal/External gripping capability

Connection port on 2 sides

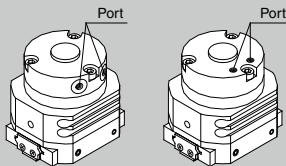

Series Variations

		(Nominal size)				Auto switch	
		10	15	20	30		
Rotary actuated air gripper	2-finger type	MHR2	●	●	●	●	P. 643 to P. 655
		MDHR2	●	●	●	●	
	3-finger type	MHR3	●	●	●	●	P. 656 to P. 663
		MDHR3	●	●	●	●	
Clean Series Rotary actuated air gripper	2-finger type	11-22-MHR2	●	●	●	●	Refer to the Web Catalog .
		11-22-MDHR2	●	●	●	●	
	3-finger type	11-22-MHR3	●	●	●	●	
		11-22-MDHR3	●	●	●	●	

Rotary Actuated Air Gripper/2-Finger Type

MHR2/MDHR2 Series

Size: 10, 15, 20, 30

How to Order

Without auto switch

MHR 2 - 10 R - []

With auto switch
(Built-in magnet)

MDHR 2 - 10 R - M9N S - []

With magnet
(For auto switch)

Number of fingers
2 2 fingers

Nominal size

10
15
20
30

Connecting port

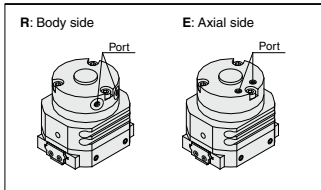

Made to Order
Refer to page 644 for details.

Number of auto switches

NII	2 pcs.
S	1 pc.

Applicable Auto Switches Refer to pages 929 to 983 for further information on auto switches.

Type	Special function	Electrical entry	Indicator light	Wiring (Output)	Load voltage		Auto switch model		Lead wire length (m) ²					Pre-wired connector	Applicable load
					DC	AC	Electrical entry direction		0.5 (NII)	1 (M)	3 (L)	5 (Z)			
							Perpendicular	In-line							
Solid state auto switch	-	Grommet	Yes	3-wire (NPN)	5V,12V	-	M9NV	M9N	●	●	●	○	○	IC circuit	Relay, PLC
				3-wire (PNP)			M9PV	M9P	●	●	●	○	○		
				2-wire	M9BV	M9B	●	●	●	○	○	—			
				3-wire (NPN)	M9NVW	M9NW	●	●	●	○	○	IC circuit			
	Diagnosis (2-color indication)			3-wire (PNP)	5V,12V	M9PWV	M9PW	●	●	●	○	○	—		
					12V	M9BWW	M9BW	●	●	●	○	○	—		
	Water resistant (2-color indicator)			3-wire (NPN)	5V,12V	M9NAV**	M9NA**	○	○	●	○	○	IC circuit		
						M9PAV**	M9PA**	○	○	●	○	○	IC circuit		
					12V	M9BAV**	M9BA**	○	○	●	○	○	—		
						M9BAV**	M9BA**	○	○	●	○	○	—		

** Water resistant type auto switches can be mounted on the above models, but in such case SMC cannot guarantee water resistance.

² Lead wire length symbols: 0.5 m NII (Example) M9N
1 m M (Example) M9NM
3 m L (Example) M9NL
5 m Z (Example) M9NZ

* Solid state auto switches marked with a "○" symbol are produced upon receipt of order.

Note) When using the 2-color indicator type, please make the setting so that the indicator is lit in red to ensure the detection at the proper position of the air gripper.

MHR2/MDHR2 Series



Model/Specifications

Nominal size	10	15	20	30	
Action	Double acting				
Gripping force (N) ⁽¹⁾ (Effective value) at 0.5 MPa	External grip	12	24	33	58
	Internal grip	12	25	34	59
Opening/ Closing stroke (Both sides)	Finger closing width (mm)	10	14	16	19
	Finger opening width (mm)	16	22	28	37
	Stroke (mm)	6	8	12	18
Weight (g) ⁽²⁾	100 (95)	180 (175)	390 (380)	760 (740)	
Connection port	M3 x 0.5		M5 x 0.8		
Repeatability	±0.01 mm				
Fluid	Air				
Operating pressure	0.2 to 0.6 MPa	0.15 to 0.6 MPa			
Ambient and fluid temperature	0 to 60°C				
Max. operating frequency	180 c.p.m				
Lubrication	Non-lube ⁽³⁾				

Symbol

Without auto switch/
Double acting

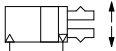

Internal grip

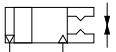

External grip

With auto switch/
Double acting

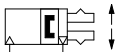

Internal grip

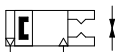

External grip



Made to Order: Individual Specifications
(For details, refer to page 670.)

Symbol	Specifications/Description
-X32	Grease change for rotary actuated part



Made to Order
[Click here for details](#)

Symbol	Specifications/Description
-X63	Fluorine grease

Note 1) Refer to page 646 "Effective Gripping Force" for details of Gripping force at each gripping point. Value of effective gripping force is measured at the middle of opening/closing stroke.

Note 2) () Value shows MDHR weight, but it does not include auto switch weight.

Note 3) This product should be used without lubrication. If it is lubricated, it could lead to sticking or slipping.

When the finger opening/closing speed is set as the total stroke of 0.2 seconds or more, it may cause the product to stick or completely stop its movement.

Gripping Point

- Workpiece gripping point should be within the gripping point range: The range shown for each operating pressure given in the graphs to the right.
- When the gripping point distance becomes large, the finger attachment applies an excessively large load to the finger sliding section, causing excessive play of the fingers and possibly leading to premature failure.

External grip

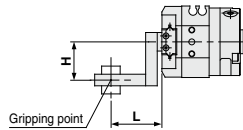
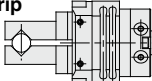

L: Distance to the gripping point
H: Overhang distance

Internal grip

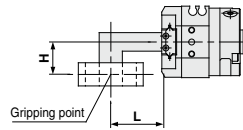
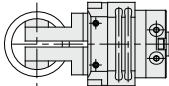

Limitation of Gripping: External Grip/Internal Grip

MHR2-10/MDHR2-10

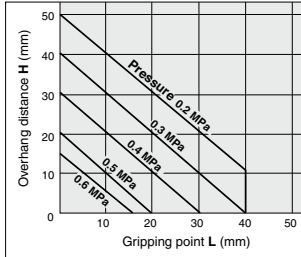

MHR2-20/MDHR2-20

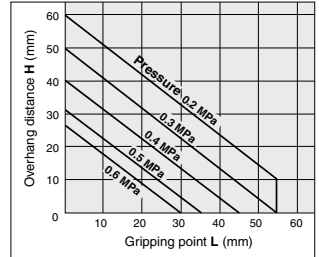

MHR2-15/MDHR2-15

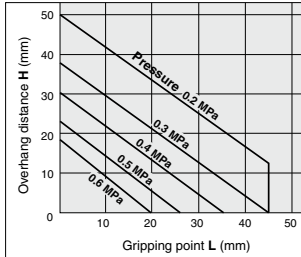

MHR2-30/MDHR2-30

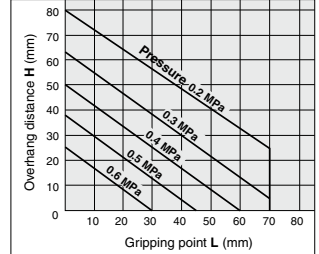

MHR2/MDHR2 Series

Effective Gripping Force

Guidelines for the selection of the gripper with respect to workpiece mass

- Although conditions differ according to the workpiece shape and the coefficient of friction between the attachments and the workpiece, select a model that can provide a gripping force of 10 to 20 times the workpiece mass, or more.
- If high acceleration, deceleration or impact forces are encountered during motion a further margin of safety should be considered.

External grip

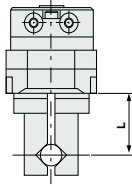

Internal grip

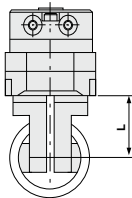

L: Gripping point length (mm)

• Indication of effective gripping force

The effective gripping force shown in the graphs to the right is expressed as F , which is the thrust of one finger, when both fingers and attachments are in full contact with the workpiece as shown in the figure below.

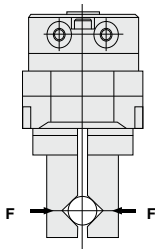

External Grip

MHR2-10/MDHR2-10

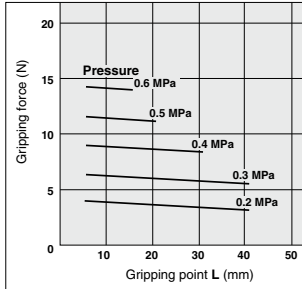

MHR2-15/MDHR2-15

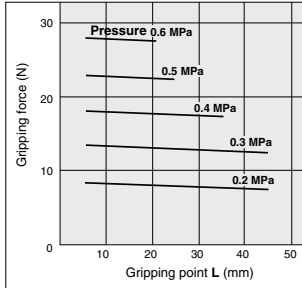

MHR2-20/MDHR2-20

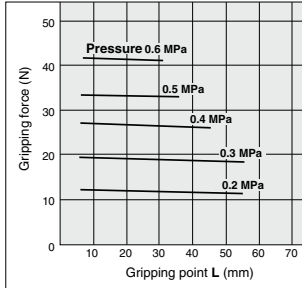

MHR2-30/MDHR2-30

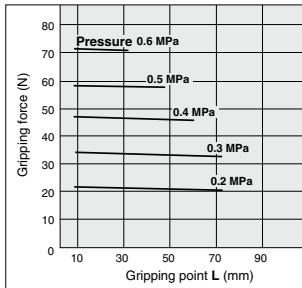

Internal Grip

MHR2-10/MDHR2-10

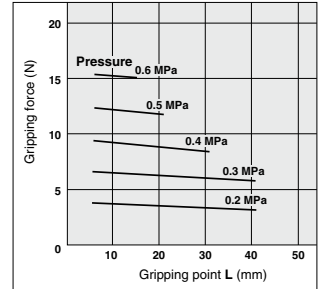

MHR2-15/MDHR2-15

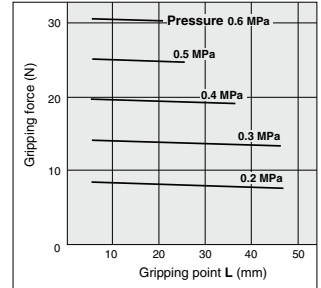

MHR2-20/MDHR2-20

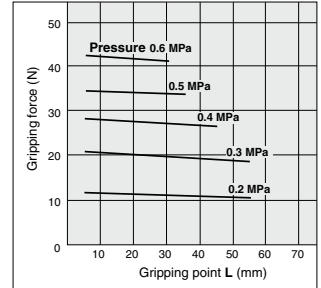

MHR2-30/MDHR2-30

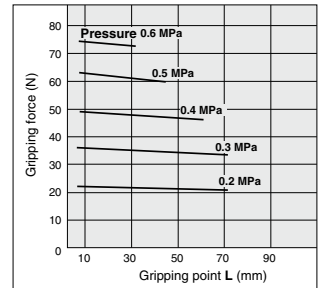

Construction

MHR2

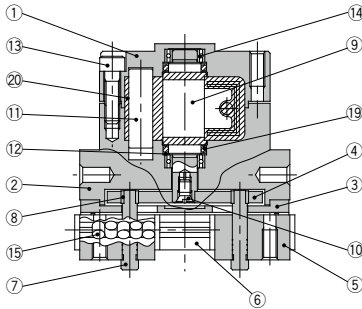

MDHR2

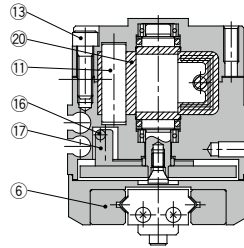
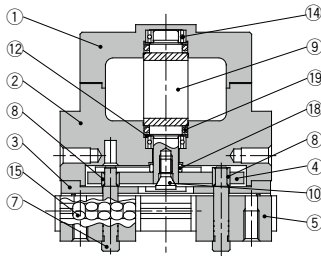

Component Parts

No.	Description	Material	Note
1	Body	Aluminum alloy	Hard anodized
2	Adaptor body	Aluminum alloy	Hard anodized
3	Guide holder	Stainless steel	
4	Cam	Cold rolled steel	Nitriding
5	Finger assembly	Stainless steel	Heat treated
6	Guide	Stainless steel	Heat treated
7	Pin	Carbon steel	Heat treated Electroless nickel plated
8	Pin roller	Stainless steel	Nitriding
9	Vane shaft	Stainless steel, NBR	MHR2-30 is carbon steel NBR
10	Joint bolt	Chrome molybdenum steel	Zinc chromated

Component Parts

No.	Description	Material	Note
11	Stopper	Resin	
12	Back-up ring	Stainless steel plate	
13	Hexagon socket head bolt	Stainless steel	
14	Bearing	High carbon chrome bearing steel	
15	Cylindrical roller	—	
16	Magnet	Stainless steel	
17	Magnet holder	Aluminum alloy	Hard anodized
18	Roller	Stainless steel	
19	O-ring	NBR	
20	Stopper seal	NBR	

MHR2/MDHR2 Series

Nominal Size 10

Without auto switch: MHR2-10R

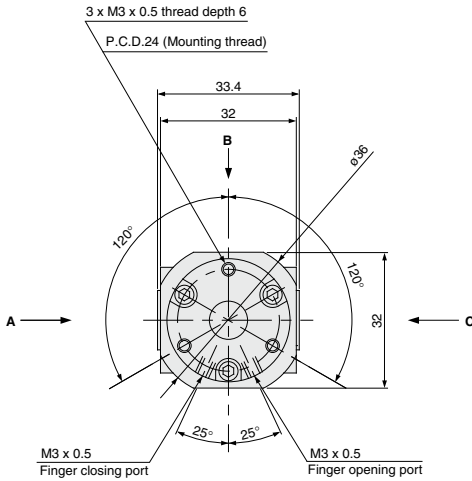

MHR2-10E Port Location

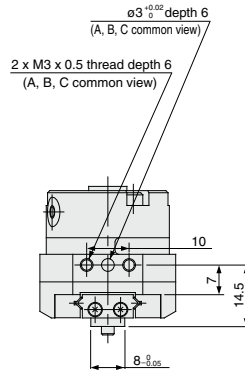
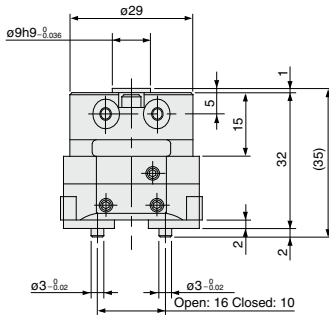
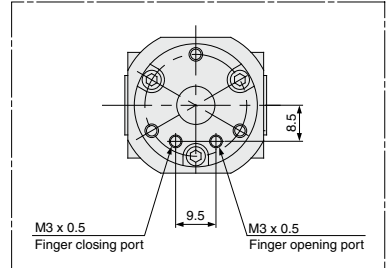

2 x M3 x 0.5 thread depth 6
(Thread for mounting attachment)

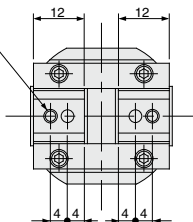

With auto switch (Built-in magnet): MDHR2-10R

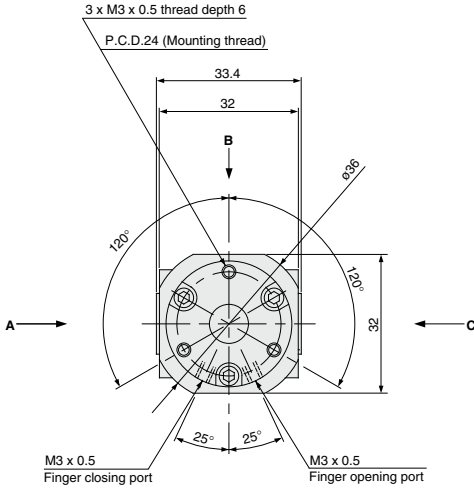

MDHR2-10E Port Location

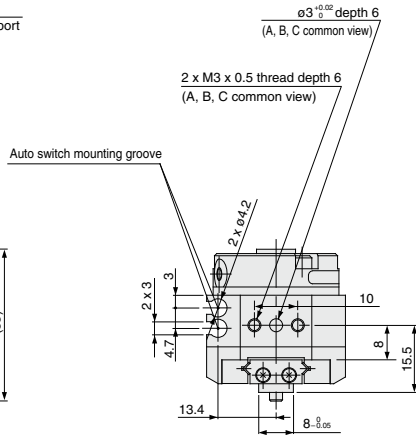
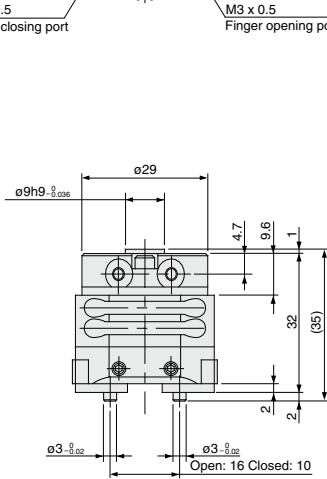
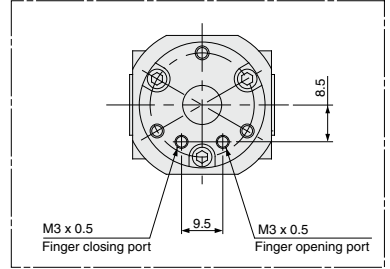

2 x M3 x 0.5 thread depth 6
(Thread for mounting attachment)

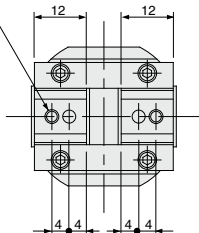

Dimensional Differences between MHR and MDHR

The following dimensions are different between MHR and MDHR series. And also, body shapes are different depending on auto switch mounting groove.

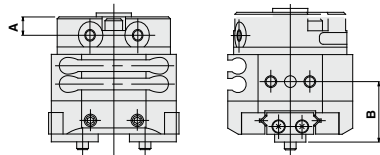

Model	A	B	
MHR2	-10R	5	14.5
	-10E	—	14.5
MDHR2	-10R	4.7	15.5
	-10E	—	15.5

MHR2/MDHR2 Series

Nominal Size 15

Without auto switch: MHR2-15R

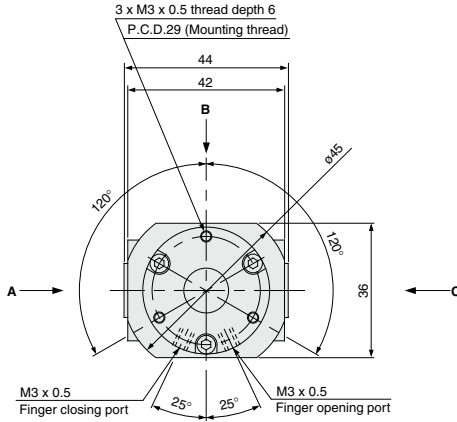

MHR2-15E Port Location

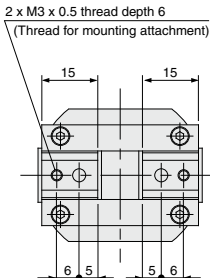
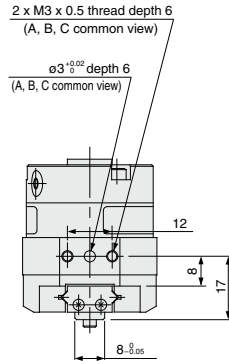
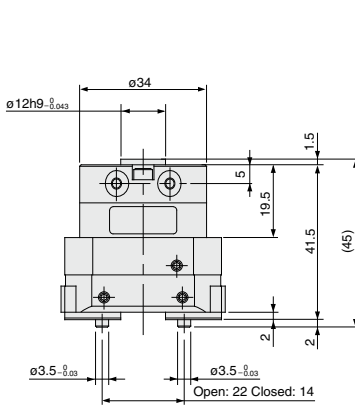
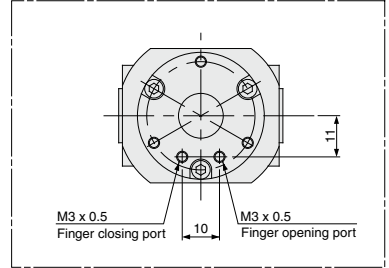

With auto switch (Built-in magnet): MDHR2-15R

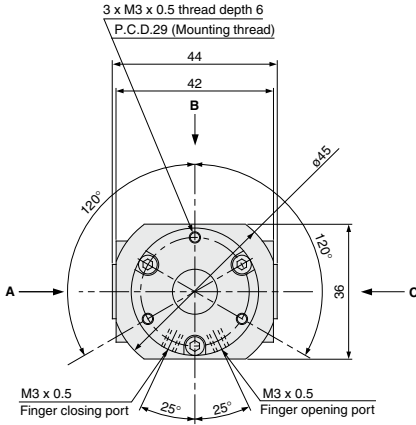

MDHR2-15E Port Location

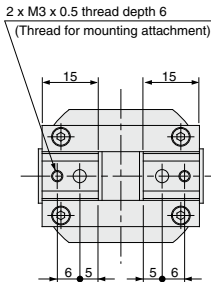
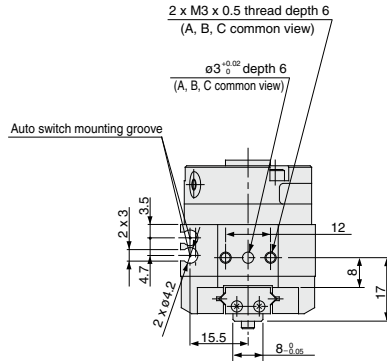
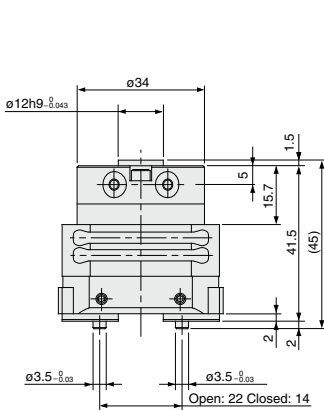
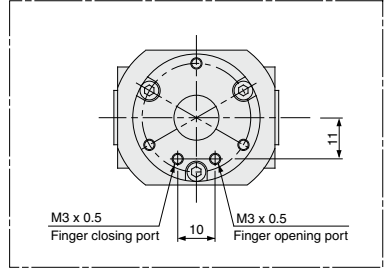

MHR2/MDHR2 Series

Nominal Size 20

Without auto switch: MHR2-20R

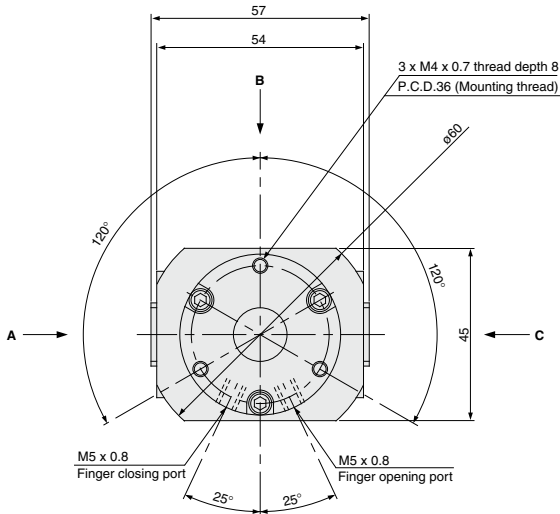

MHR2-20E Port Location

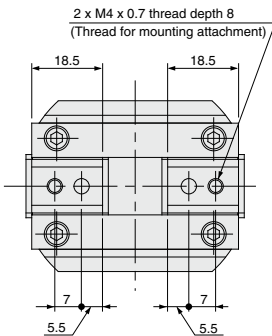
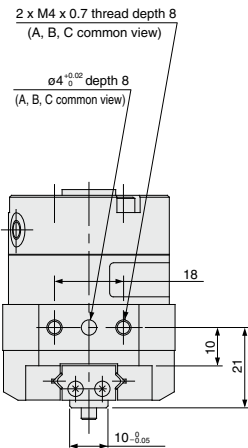
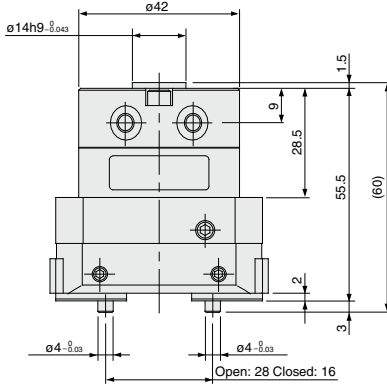
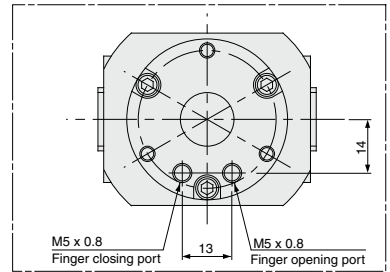

MHR2/MDHR2 Series

Nominal Size 30

Without auto switch: MHR2-30R

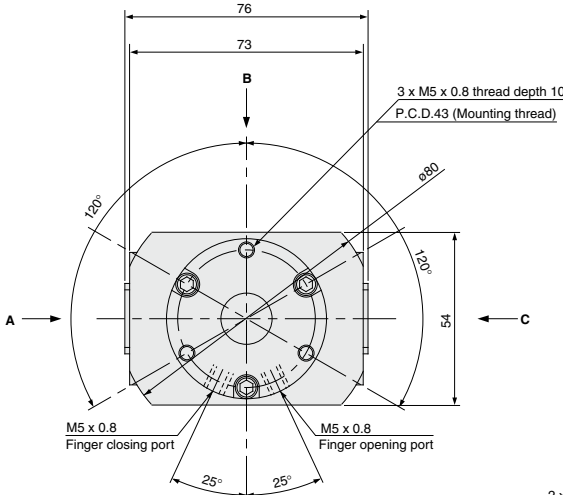

MHR2-30E Port Location

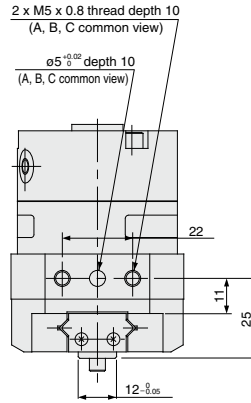
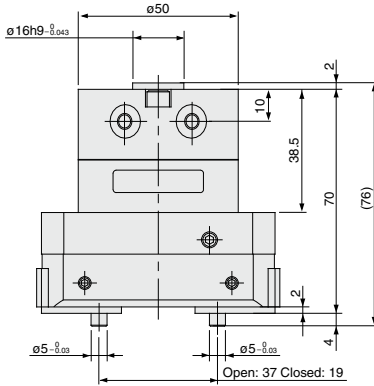
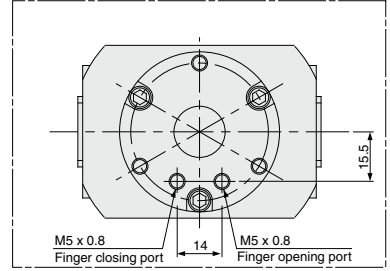

$2 \times M5 \times 0.8$ thread depth 10
(Thread for mounting attachment)

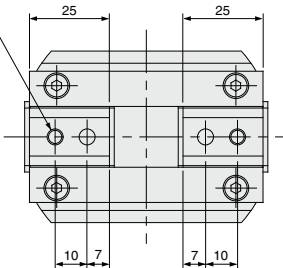

With auto switch (Built-in magnet): MDHR2-30R

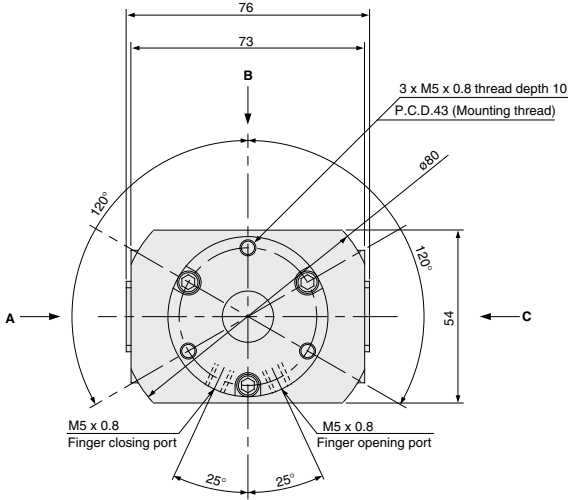

MDHR2-30E Port Location

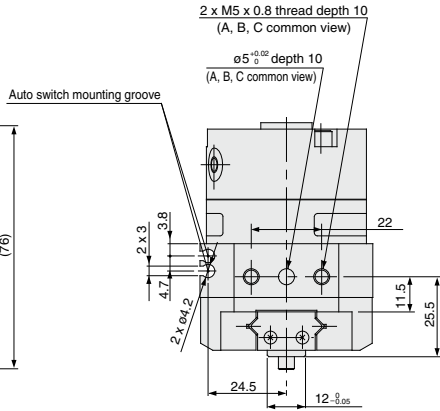
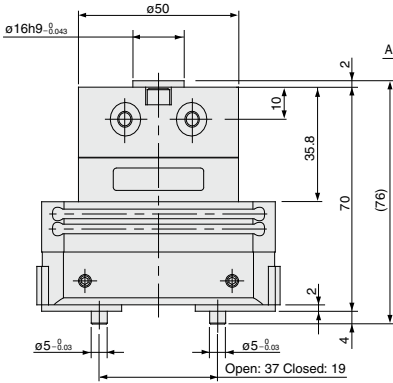
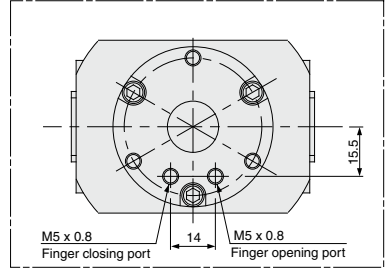

2 x M5 x 0.8 thread depth 10
(Thread for mounting attachment)

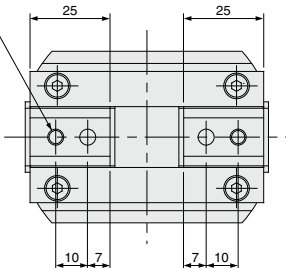

Dimensional Differences between MHR and MDHR

The following dimensions are different between the MHR and MDHR series. And also, body shapes are different depending on auto switch mounting groove.

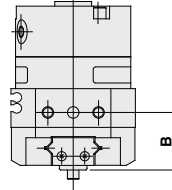

Model	B
MHR2-30□	25
MDHR2-30□	25.5

Rotary Actuated Air Gripper/3-Finger Type

MHR3/MDHR3 Series

Size: 10, 15

How to Order

Without auto switch

MHR 3 - 10 R - []

With auto switch
(Built-in magnet)

MDHR 3 - 10 R - M9N S - []

With magnet
(For auto switch)

Number of fingers
3 3 fingers

Nominal size
10
15

Connecting port

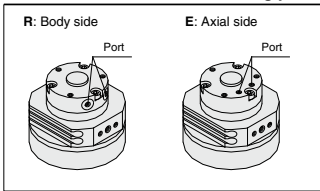

Connecting port

R Body side

R: Body side

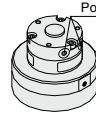

Made to Order
Refer to page 657 for details.

Number of auto switches

NIL	2 pcs.
S	1 pc.

Applicable Auto Switches/Refer to pages 929 to 983 for further information on auto switches.

Type	Special function	Electrical entry	Indicator light	Wiring (Output)	Load voltage		Auto switch model		Lead wire length (m) ¹⁾				Pre-wired connector	Applicable load		
					DC	AC	Electrical entry direction		0.5 (Nil)	1 (M)	3 (L)	5 (Z)		IC circuit	Relay, PLC	
							Perpendicular	In-line								
Solid state auto switch	—	Grommet	Yes	3-wire (NPN)	5V, 12V	—	M9NV	M9N	●	●	●	○	○	IC circuit	—	
				3-wire (PNP)			M9PV	M9P	●	●	●	○	○			
	Diagnosis (2-color indication)			2-wire	12V	—	M9BV	M9B	●	●	●	○	○	—	—	
				3-wire (NPN)			M9NVW	M9NW	●	●	●	○	○			
	Water resistant (2-color indicator)			3-wire (PNP)	5V, 12V	24V	—	M9PWV	M9PW	●	●	●	○	○	IC circuit	Relay, PLC
				2-wire				M9BWV	M9BW	●	●	●	○	○		
				3-wire (NPN)	5V, 12V	—	M9NAV**	M9NA**	○	○	●	○	○	IC circuit		
				3-wire (PNP)			M9PAV**	M9PA**	○	○	●	○	○			
				2-wire	12V	—	M9BAV**	M9BA**	○	○	○	○	○	—		
				2-wire			M9BAV**	M9BA**	○	○	○	○	○			

** Water resistant type auto switches can be mounted on the above models, but in such case SMC cannot guarantee water resistance.

¹⁾ Lead wire length symbols: 0.5 m..... Nil (Example) M9N
1 m..... M (Example) M9NM
3 m..... L (Example) M9NL
5 m..... Z (Example) M9NZ

* Solid state auto switches marked with a "○" symbol are produced upon receipt of order.

Note) When using the 2-color indicator type, please make the setting so that the indicator is lit in red to ensure the detection at the proper position of the air gripper.

Rotary Actuated Air Gripper 3-Finger Type **MHR3/MDHR3 Series**



Model/Specifications

Nominal size		10	15
Action		Double acting	
Holding force (N) (Effective value)⁽¹⁾ at 0.5 MPa	External grip	7	13
	Internal grip	6.5	12
Opening/Closing stroke (Diameter)	Finger closing width (mm)	16	19
	Finger opening width (mm)	22	27
	Stroke (mm)	6	8
Weight (g)⁽²⁾		120 (125)	225 (230)
Connection port		M3 x 0.5	
Repeatability		±0.01 mm	
Fluid		Air	
Operating pressure		0.2 to 0.6 MPa	0.15 to 0.6 MPa
Ambient and fluid temperature		0 to 60°C	
Max. operating frequency		180 c.p.m	
Lubrication		Non-lube ⁽³⁾	

Symbol

Without auto switch/
Double acting

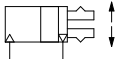

Internal grip



External grip

With auto switch/
Double acting

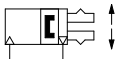

Internal grip

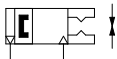

External grip

Note 1) Refer to page 658 "Effective Gripping Force" for details of gripping force at each gripping point.
Valve of effective gripping force is measured at the middle of opening/closing stroke.

Note 2) () Value shows MDHR weight, but it does not include auto switch weight.

Note 3) This product should be used without lubrication. If it is lubricated, it could lead to sticking or slipping.

When the finger opening/closing speed is set as the total stroke of 0.2 seconds or more, it may cause the product to stick or completely stop its movement.



Made to Order: Individual Specifications
(For details, refer to page 670.)

Symbol	Specifications/Description
-X32	Grease change for rotary actuated part



Made to Order
[Click here for details](#)

Symbol	Specifications/Description
-X63	Fluorine grease

MHR3/MDHR3 Series

Gripping Point

External grip

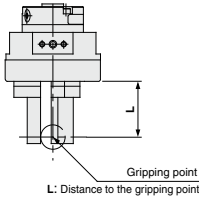

Internal grip

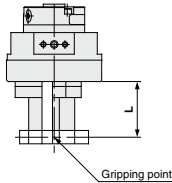

Limitation of Gripping: External Grip/Internal Grip

• Workpiece gripping point should be within the gripping point range: L shown below, by operating pressure.

• When the gripping point distance becomes large, the finger attachment applies an excessively large load to the finger sliding section, causing excessive play of the fingers and possibly leading to premature failure.

MHR3-10R/MDHR3-10□

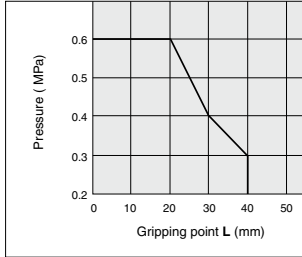

MHR3-15R/MDHR3-15□

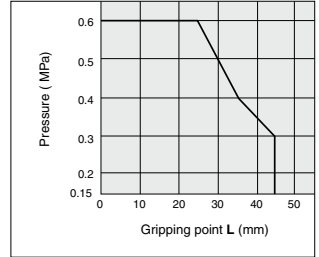

Effective Gripping Force

Guidelines for the selection of the gripper with respect to workpiece mass

- Selection of the correct model depends upon the workpiece mass, the coefficient of friction between the finger attachment and the component, and their respective configurations. A model should be selected with a gripping force of 7 to 14 times that of the workpiece mass.
- If high acceleration, deceleration or impact forces are encountered during motion, a further margin of safety should be considered.

External grip

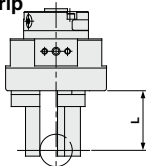

Internal grip

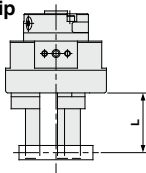

• Indication of effective gripping force

The effective gripping force shown in the graphs to the right is expressed as F_1 , which is the thrust of one finger, when three fingers and attachments are in full contact with the workpiece as shown in the figure to the right.

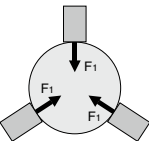

External Grip

MHR3-10R/MDHR3-10□

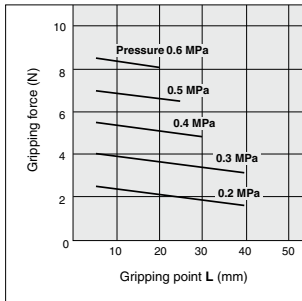

Internal Grip

MHR3-10R/MDHR3-10□

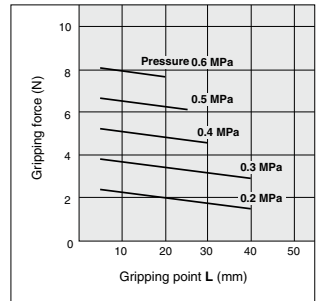

MHR3-15R/MDHR3-15□

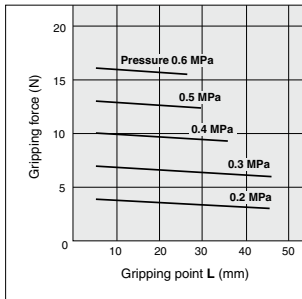

MHR3-15R/MDHR3-15□

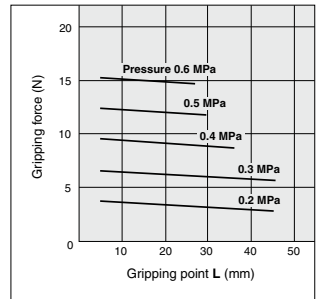

Construction

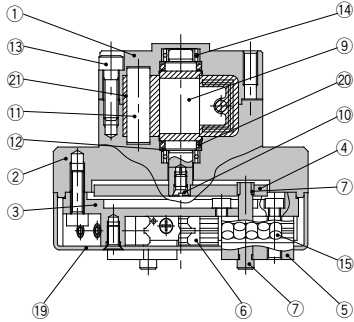

MDHR3

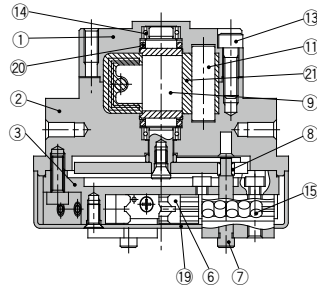
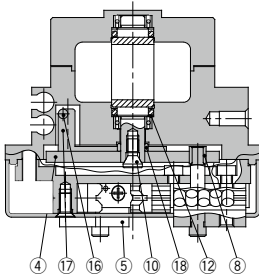

Component Parts

No.	Description	Material	Note
1	Body	Aluminum alloy	Hard anodized
2	Adaptor body	Aluminum alloy	Hard anodized
3	Guide holder	Stainless steel	
4	Cam	Cold rolled steel	Nitriding
5	Finger assembly	Stainless steel	Heat treated
6	Guide	Stainless steel	Heat treated
7	Pin	Carbon steel	Heat treated Electroless nickel plated
8	Pin roller	Stainless steel	Nitriding
9	Vane shaft	Stainless steel, NBR	
10	Joint bolt	Chrome molybdenum steel	Zinc chromated
11	Stopper	Resin	

No.	Description	Material	Note
12	Back-up ring	Stainless steel plate	
13	Hexagon socket head bolt	Stainless steel	
14	Bearing	High carbon chrome bearing steel	
15	Cylindrical roller	Stainless steel	
16	Magnet	—	
17	Magnet holder	Aluminum alloy	Hard anodized
18	Roller	Stainless steel	
19	Cover	Aluminum alloy	Hard anodized
20	O-ring	NBR	
21	Stopper seal	Chrome molybdenum steel	

Replacement Parts

Description	M□HR3-10□	M□HR3-15□	Main parts
Cover	P3313128	P3313228	(19)

MHR3/MDHR3 Series

Nominal Size 10

Without auto switch: MHR3-10R

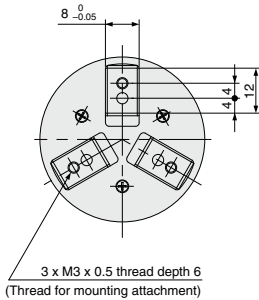
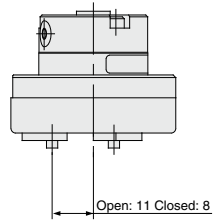
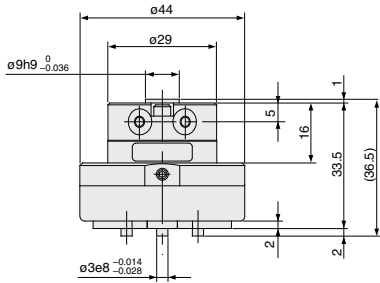
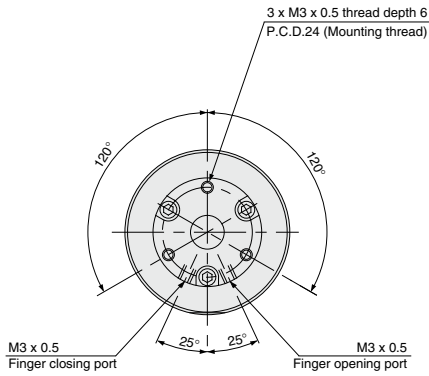

With auto switch (Built-in magnet): MDHR3-10R

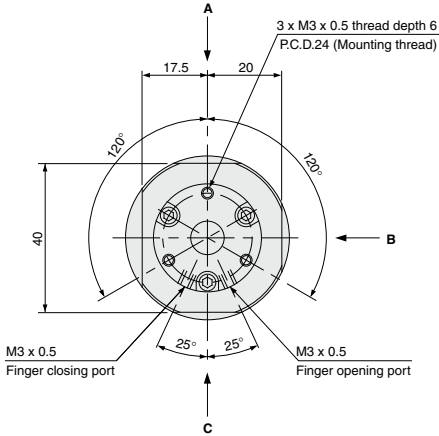

MDHR3-10E Port Location

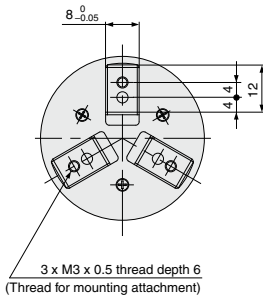
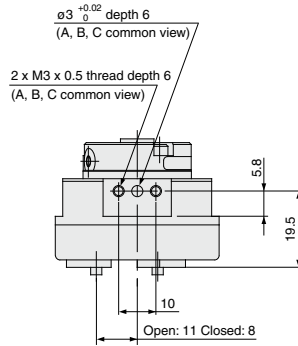
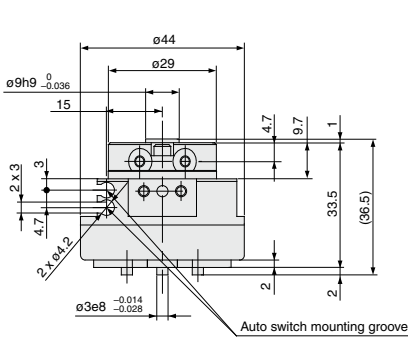
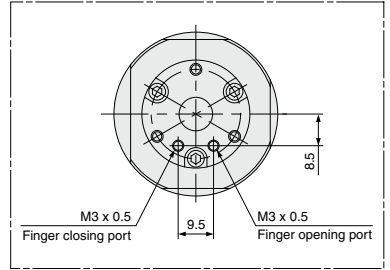

Dimensional Differences between MHR and MDHR

The following dimensions are different between the MHR and MDHR series. And also, body shapes are different depending on auto switch mounting groove.

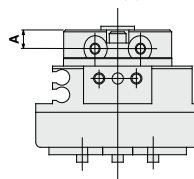

Model	A
MHR3-10R	5
MDHR3-10R	4.7

MHR3/MDHR3 Series

Nominal Size 15

Without auto switch: MHR3-15R

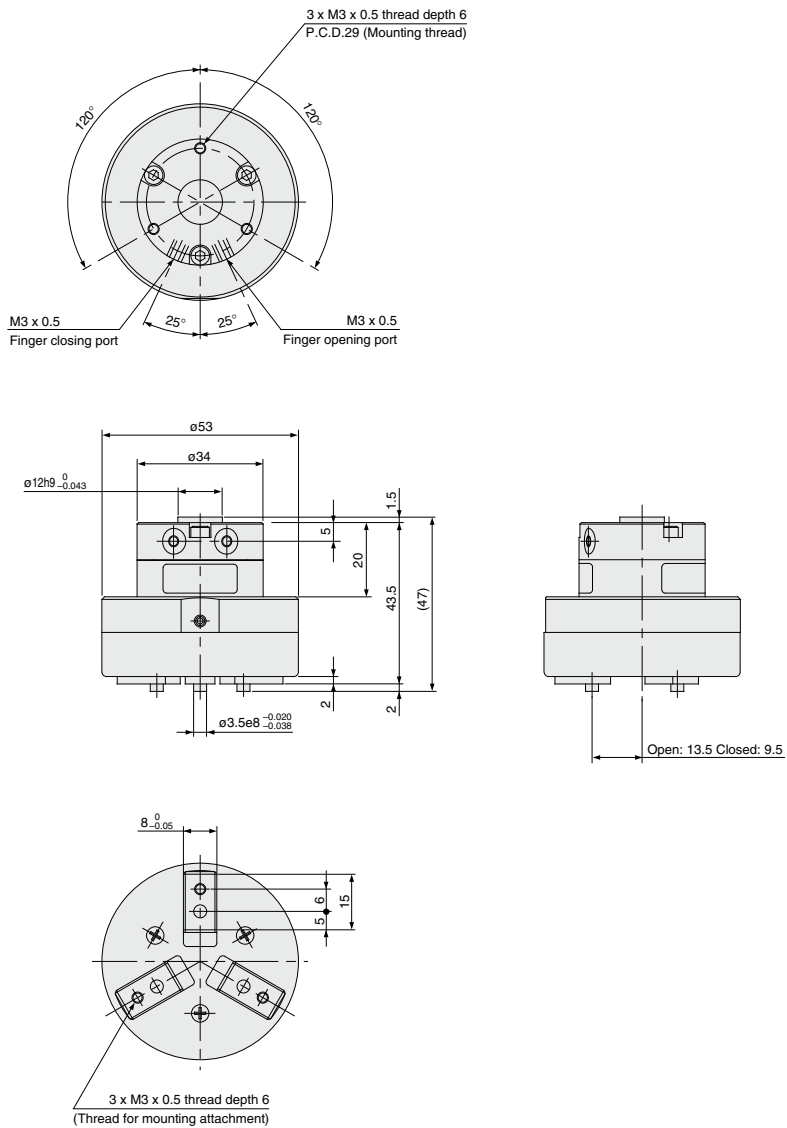

With auto switch (Built-in magnet): MDHR3-15R

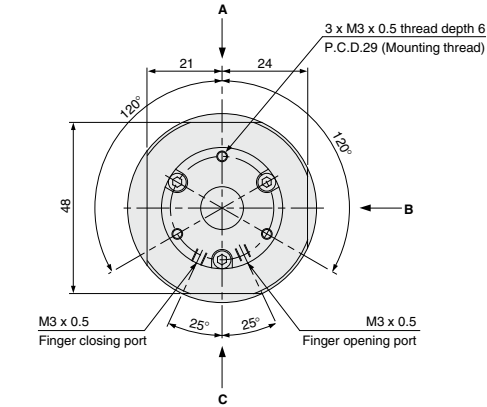

MDHR3-15E Port Location

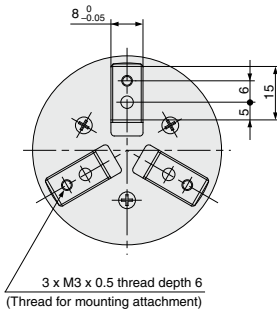
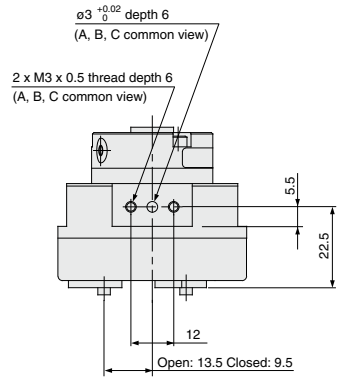
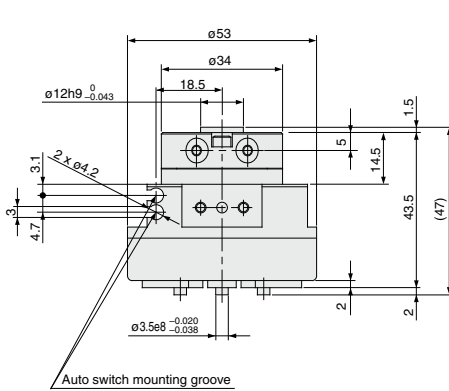
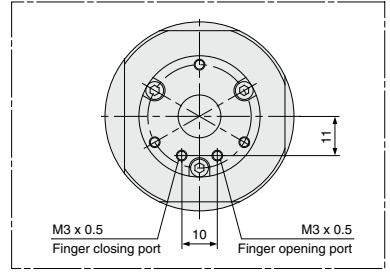

MDHR2/MDHR3 Series

Auto Switch Installation Examples and Mounting Positions

Various auto switch applications are possible through different combinations of auto switch quantities and detecting positions.



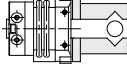
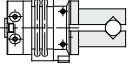
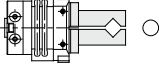
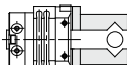
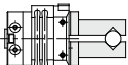
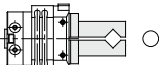
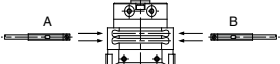
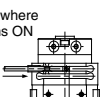
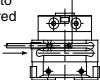
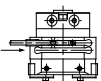
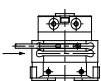
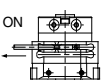
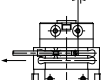



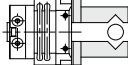
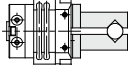
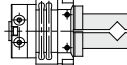

1) Detection when Gripping Exterior of Workpiece/Auto Switch Mounted from Direction A

Detection example		1. Confirmation of fingers in reset position	2. Confirmation of workpiece held	3. Confirmation of workpiece released
Position to be detected		Position of fingers fully opened 	Position when gripping a workpiece 	Position of fingers fully closed 
Operation of auto switch		Auto switch turned ON when fingers return. (Light ON)	Auto switch turned ON when gripping a workpiece. (Light ON)	When a workpiece is not held (Abnormal operation): Auto switch to turn ON (Light ON)
Detection combinations	One auto switch + One position, any of ①, ② and ③ can be detected.	●	●	●
	Two auto switches + Two positions of ①, ② and ③ can be detected.	A	●	—
		B	—	●
C	●	—	●	
How to determine auto switch installation position		Step 1) Fully open the fingers. 	Step 1) Position fingers for gripping a workpiece. 	Step 1) Fully close the fingers. 
At no pressure or low pressure, connect the auto switch to a power supply, and follow the directions.		In the case of mounting auto switch from A direction Step 2) Insert the auto switch into the auto switch installation groove from direction A. 		
		Step 3) Slide the auto switch in the direction of the arrow until the light illuminates and fasten it at a position 0.3 to 0.5 mm in the direction of the arrow beyond the position where the indicator light illuminates. Position where light turns ON  0.3 to 0.5mm Position to be secured 	Step 3) Slide the auto switch in the direction of the arrow until the indicator light illuminates.  Step 4) Slide the auto switch in the direction of the arrow until the indicator light goes out.  Step 5) Move the auto switch in the opposite direction, and fasten it at a position 0.3 to 0.5 mm in the direction of the arrow beyond the position where the indicator light illuminates. Position where light turns ON  0.3 to 0.5 mm Position to be secured 	

Note 1) It is recommended that gripping of a workpiece be performed close to the center of the finger stroke.

Note 2) When holding a workpiece close at the end of open/close stroke of fingers, detecting performance of the combinations listed in the above table may be limited, depending on the hysteresis of an auto switch, etc.

2) Detection when Gripping Exterior of Workpiece/Auto Switch Mounted from Direction B

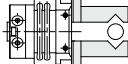
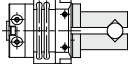
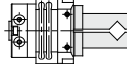
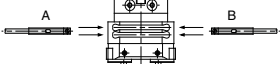
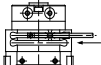
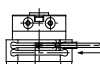
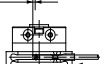
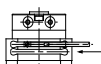
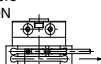
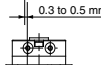
Detection example		1. Confirmation of fingers in reset position	2. Confirmation of workpiece held	3. Confirmation of workpiece released
Position to be detected		Position of fingers fully opened 	Position when gripping a workpiece 	Position of fingers fully closed 
Operation of auto switch		Auto switch turned ON when fingers return. (Light ON)	Auto switch turned ON when gripping a workpiece. (Light ON)	When a workpiece is not held (Abnormal operation): Auto switch to turn ON (Light ON)
Detection combinations	One auto switch <small>* One position, any of ①, ② and ③ can be detected.</small>			
	Two auto switches <small>* Two positions of ①, ② and ③ can be detected.</small>	A 	A 	—
	Pattern	B 	B 	C 
How to determine auto switch installation position		Step 1) Fully open the fingers. 	Step 1) Position fingers for gripping a workpiece. 	Step 1) Fully close the fingers. 
At no pressure or low pressure, connect the auto switch to a power supply, and follow the directions.		In the case of mounting auto switch from B direction Step 2) Insert the auto switch into the auto switch installation groove from direction B. <div style="text-align: center; margin-top: 10px;">  </div>		
		Step 3) Slide the auto switch in the direction of the arrow until the indicator light illuminates. <div style="text-align: center; margin-top: 10px;">  </div>	Step 3) Slide the auto switch in the direction of the arrow until the indicator light illuminates. Move the switch an additional 0.3 to 0.5 mm in the direction of the arrow and fasten it. <div style="text-align: center; margin-top: 10px;">  <p style="text-align: center;">Position where light turns ON</p> </div> <div style="text-align: center; margin-top: 10px;">  <p style="text-align: center;">0.3 to 0.5 mm</p> <p style="text-align: center;">Position to be secured</p> </div>	
		Step 4) Slide the auto switch in the direction of the arrow until the indicator light goes out. <div style="text-align: center; margin-top: 10px;">  </div>		
		Step 5) Move the auto switch in the opposite direction and fasten it at a position 0.3 to 0.5 mm beyond the position where the indicator light illuminates. <div style="text-align: center; margin-top: 10px;">  <p style="text-align: center;">Position where light turns ON</p> </div> <div style="text-align: center; margin-top: 10px;">  <p style="text-align: center;">0.3 to 0.5 mm</p> <p style="text-align: center;">Position to be secured</p> </div>		

Note 1) It is recommended that gripping of a workpiece be performed close to the center of the finger stroke.







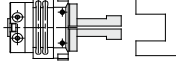
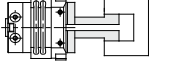

Note 2) When holding a workpiece close at the end of open/close stroke of fingers, detecting performance of the combinations listed in the above table may be limited, depending on the hysteresis of an auto switch, etc.

MDHR2/MDHR3 Series

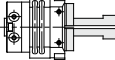
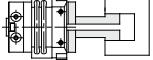
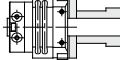
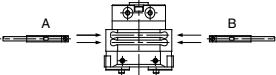
Auto Switch Installation Examples and Mounting Positions

Various auto switch applications are possible through different combinations of auto switch quantities and detecting positions.







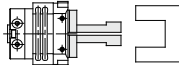
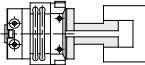
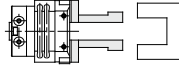
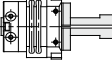
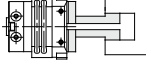
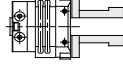
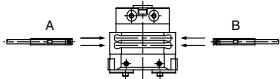

3) Detection when Gripping Interior of Workpiece/Auto Switch Mounted from Direction A

Detection example		1. Confirmation of fingers in reset position	2. Confirmation of workpiece held	3. Confirmation of workpiece released
Position to be detected		Position of fingers fully closed 	Position when gripping a workpiece 	Position of fingers fully opened 
Operation of auto switch		Auto switch turned ON when fingers return. (Light ON)	Auto switch turned ON when gripping a workpiece. (Light ON)	When a workpiece is not held (Abnormal operation): Auto switch to turn ON (Light ON)
Detection combinations	One auto switch ⇒ One position, any of ①, ② and ③ can be detected.	●	●	●
	Two auto switches ⇒ Two positions of ①, ② and ③ can be detected.	A	●	—
		B	—	●
C	●	—	●	
How to determine auto switch installation position		Step 1) Fully close the fingers. 	Step 1) Position fingers for gripping a workpiece. 	Step 1) Fully open the fingers. 
At no pressure or low pressure, connect the auto switch to a power supply, and follow the directions.		<p>In the case of mounting auto switch from A direction Step 2) Insert the auto switch into the auto switch installation groove from direction A.</p> 		
		<p>Step 3) Slide the auto switch in the direction of the arrow until the indicator light illuminates.</p> 	<p>Step 3) Slide the auto switch in the direction of the arrow until the indicator light illuminates. Move the switch an additional 0.3 to 0.5 mm in the direction of the arrow and fasten it.</p>	
		<p>Step 4) Slide the auto switch in the direction of the arrow until the indicator light goes out.</p> 	<p>Position where light turns ON</p> 	
		<p>Step 5) Move the auto switch in the opposite direction and fasten it at a position 0.3 to 0.5 mm beyond the position where the indicator light illuminates.</p> <p>Position where light turns ON</p>  <p>0.3 to 0.5 mm</p> <p>Position to be secured</p> 	<p>Position to be secured</p> 	

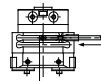
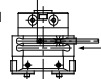
Note 1) It is recommended that gripping of a workpiece be performed close to the center of the finger stroke.

Note 2) When holding a workpiece close at the end of open/close stroke of fingers, detecting performance of the combinations listed in the above table may be limited, depending on the hysteresis of an auto switch, etc.

4) Detection when Gripping Interior of Workpiece/Auto Switch Mounted from Direction B

Detection example		1. Confirmation of fingers in reset position	2. Confirmation of workpiece held	3. Confirmation of workpiece released
Position to be detected		Position of fingers fully closed 	Position when gripping a workpiece 	Position of fingers fully opened 
Operation of auto switch		Auto switch turned ON when fingers return. (Light ON)	Auto switch turned ON when gripping a workpiece. (Light ON)	When a workpiece is not held (Abnormal operation): Auto switch to turn ON (Light ON)
Detection combinations	One auto switch → One position, any of ①, ② and ③ can be detected.	●	●	●
	Two auto switches → Two positions of ①, ② and ③ can be detected.	A ●	●	—
	Pattern	B —	●	●
C ●	—	—	●	
How to determine auto switch installation position		Step 1) Fully close the fingers. 	Step 1) Position fingers for gripping a workpiece. 	Step 1) Fully open the fingers. 
At no pressure or low pressure, connect the auto switch to a power supply, and follow the directions.		In the case of mounting auto switch from B direction Step 2) Insert the auto switch into the auto switch installation groove from direction B. 		
Step 3) Slide the auto switch in the direction of the arrow until the light illuminates and fasten it at a position 0.3 to 0.5 mm in the direction of the arrow beyond the position where the indicator light illuminates.		Step 3) Slide the auto switch in the direction of the arrow until the indicator light illuminates. 		
Position where light turns ON  Position to be secured  0.3 to 0.5 mm		Step 4) Slide the auto switch in the direction of the arrow until the indicator light goes out. 		
Step 5) Move the auto switch in the opposite direction, and fasten it at a position 0.3 to 0.5 mm in the direction of the arrow beyond the position where the indicator light illuminates.		Step 5) Move the auto switch in the opposite direction, and fasten it at a position 0.3 to 0.5 mm in the direction of the arrow beyond the position where the indicator light illuminates. 		
Position where light turns ON  Position to be secured  0.3 to 0.5 mm		Position where light turns ON  Position to be secured  0.3 to 0.5 mm		

Note 1) It is recommended that gripping of a workpiece be performed close to the center of the finger stroke.

Note 2) When holding a workpiece close at the end of open/close stroke of fingers, detecting performance of the combinations listed in the above table may be limited, depending on the hysteresis of an auto switch, etc.

MHR2/MDHR2 Series

Auto Switch Mounting

To set the auto switch, insert the auto switch into the installation groove of the gripper from the direction indicated in the following drawing. After setting the position, tighten the attached auto switch mounting set screw with a flat head watchmaker's screwdriver.

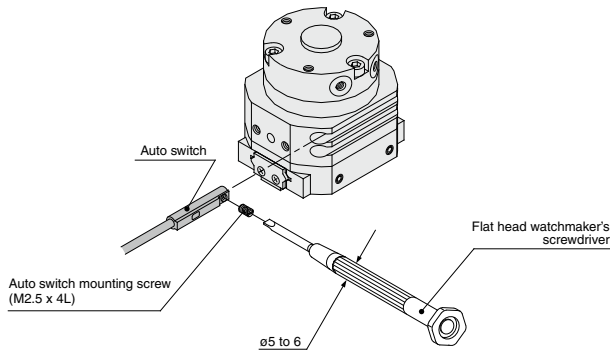

Note) Use a watchmaker's screwdriver with a grip diameter of 5 to 6 mm to tighten the auto switch mounting screw. Also, tighten with a torque of about 0.05 to 0.15 N·m, or about 0.05 to 0.10 N·m for D-M9□A(V).

Auto Switch Hysteresis

Please refer to the table as a guide when setting auto switch positions.

Model	Hysteresis (Max. value) (mm)
MDHR2-10	0.3
MDHR2-15	0.2
MDHR2-20	0.6
MDHR2-30	0.3

MDHR2

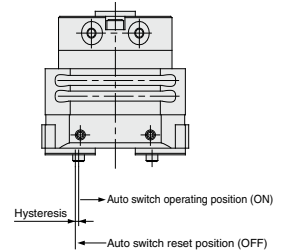

Protrusion of Auto Switch from Edge of Body

The maximum protrusion of an auto switch (when fingers are fully open) from the edge of the body is shown in the table below. Use the table as a guideline for mounting.

MDHR2-10, 15

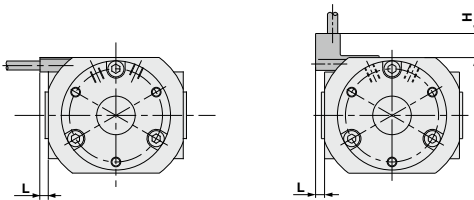

Auto switches of D-M9N, D-M9P, D-M9B, and D-M9□A are used.

Auto switches of D-M9NV, D-M9PV, D-M9BV, and D-M9□AV are used.

Max. Protrusion of Auto Switch from Edge of Body: L, H (mm)

Auto switch model		Auto switch model			
		D-M9□ D-M9□W	D-M9□A	D-M9□V M9□WV	D-M9□AV
Air gripper model	L	2.6	4.6	0.6	2.6
	H	—	—	7	6.8
MDHR2-15	L	—	—	—	—
	H	—	—	7	6.8

MDHR2-20, 30

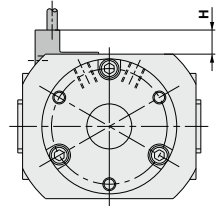

Auto switches of D-M9NV, D-M9PV, D-M9BV, and D-M9□AV are used.

Max. Protrusion of Auto Switch from Edge of Body: H (mm)

Auto switch model		Auto switch model	
		D-M9□V M9□WV	D-M9□AV
Air gripper model	L	7	6.8
	H	7	6.8

The auto switch will not protrude in the case of D-M9□.

Auto Switch Mounting

To set the auto switch, insert the auto switch into the installation groove of the gripper from the direction indicated in the following drawing. After setting the position, tighten the attached auto switch mounting set screw with a flat head watchmaker's screwdriver.

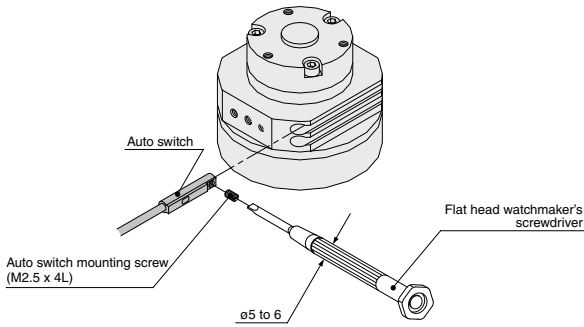

Note) Use a watchmaker's screwdriver with a grip diameter of 5 to 6 mm to tighten the auto switch mounting screw. Also, tighten with a torque of about 0.05 to 0.15 N·m, or about 0.05 to 0.10 N·m for D-M9□(V).

Auto Switch Hysteresis

Please refer to the table as a guide when setting auto switch positions.

Model	Hysteresis (Max.value) (mm)
MDHR3-10	0.2
MDHR3-15	0.5

MDHR3

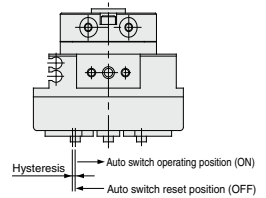

Protrusion of Auto Switch from Edge of Body

The maximum protrusion of an auto switch (when fingers are fully open) from the edge of the body is shown in the table below. Use the table as a guideline for mounting.

MDHR3-10

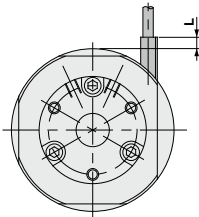

When auto switches of D-M9□ and D-M9□A are used.

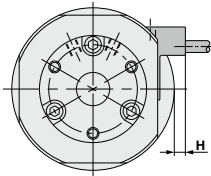

When auto switches of D-M9□V and D-M9□AV are used.

MDHR3-15

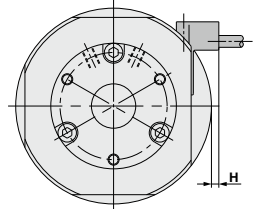

When auto switches of D-M9□V and D-M9□AV are used.

Max. Protrusion of Auto Switch from Edge of Body: L, H

(mm)

Auto switch model	D-M9□ D-M9□W	D-M9□A	D-M9□V M9□VV	D-M9□AV
L	—	—	—	—
H	—	—	2.5	2.3

Max. Protrusion of Auto Switch from Edge of Body: H

(mm)

Auto switch model	D-M9□V M9□VV	D-M9□AV
H	1.5	1.3

The auto switch will not protrude in the case of D-M9□.

MHR2, MDHR2/MHR3, MDHR3 Series

Made to Order: Individual Specifications

Please contact SMC for detailed dimensions, specifications, and delivery times.



1 Grease Change for Rotary Actuated Part

Symbol

-X32

As a measure against condensation, grease used for the rotary actuated part has been changed to SMC-GF1. The grease used for the finger part and cam part has not been changed. (GR-S is still used.)

How to Order

MHR2
MDHR2 — Standard part number — **X32**
MHR3
MDHR3

↓
Grease Change for Rotary Actuated Part •

Specifications

Grease	Fluorine grease (SMC-GF1)
Specifications/dimensions other than the above	Same as the standard type

Note) Do not use for lubrication.



MHR2, MDHR2/MHR3, MDHR3 Series Specific Product Precautions

Be sure to read this before handling the products. Refer to page 7 for safety instructions and pages 14 to 22 for air gripper and auto switch precautions.

Mounting Air Grippers/MHR2/MHR3

Mounting direction of each model is different. Refer to the table at right.

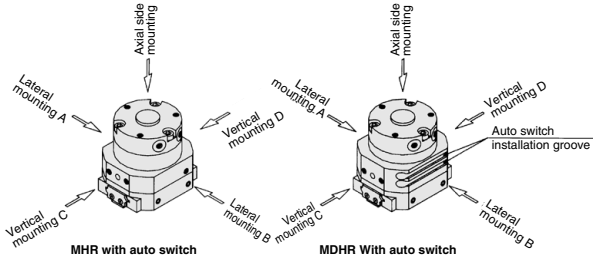

Model	Axial side mounting	Lateral mounting			Vertical mounting	
		A	B	C	D	E
MHR2-□	●	—	—	●	●	—
MHR3-□	●	—	—	—	—	—
MDHR2-□	●	●	—	—	●	—
MDHR3-□	●	●	●	—	—	●

Axial side mounting

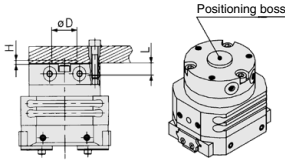

Model	Applicable bolt	Max. tightening torque N·m	Max. screw-in depth Lmm	Positioning boss		
				Dmm	Hmm	
MHR	2 -10	M3 x 0.5	0.88	6	9H9 $\frac{0}{+0.016}$	1.5
	-15				12H9 $\frac{0}{+0.043}$	1.5
	2 -20	M4 x 0.7	2.1	8	14H9 $\frac{0}{+0.043}$	1.5
MDHR	3 -30	M5 x 0.8	4.3	10	16H9 $\frac{0}{+0.053}$	2
	-10	M3 x 0.5	0.88	6	9H9 $\frac{0}{+0.016}$	1
-15	12H9 $\frac{0}{+0.043}$				1.5	

Lateral mounting

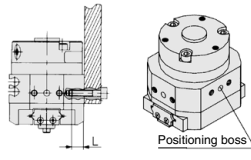

Model	Applicable bolt	Max. tightening torque N·m	Max. screw-in depth Lmm	Positioning boss		
				Bore Depth dmm	Bore Depth hmm	
MHR	2 -10	M3 x 0.5	0.88	6	3 $\frac{+0.002}{0}$	6
	-15				4 $\frac{+0.002}{0}$	8
	2 -20	M4 x 0.7	2.1	8	4 $\frac{+0.002}{0}$	8
MDHR	3 -30	M5 x 0.8	4.3	10	5 $\frac{+0.002}{0}$	10
	-10	M3 x 0.5	0.88	6	3 $\frac{+0.002}{0}$	6
-15	4 $\frac{+0.002}{0}$				8	

Vertical mounting

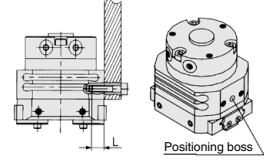

Model	Applicable bolt	Max. tightening torque N·m	Max. screw-in depth Lmm	Positioning boss		
				Bore Depth dmm	Bore Depth hmm	
MHR	2 -10	M3 x 0.5	0.88	6	3 $\frac{+0.002}{0}$	6
	-15				4 $\frac{+0.002}{0}$	8
	2 -20	M4 x 0.7	2.1	8	4 $\frac{+0.002}{0}$	8
MDHR	3 -30	M5 x 0.8	4.3	10	5 $\frac{+0.002}{0}$	10
	-10	M3 x 0.5	0.88	6	3 $\frac{+0.002}{0}$	6
-15	4 $\frac{+0.002}{0}$				8	

How to Locate Finger and Attachment

- Positioning in the finger's open/close direction**
Position the finger and the attachment by inserting the finger's pin into the attachment's pin insertion hole. Provide the following pin insertion hole dimensions: shaft-basis fitting dimension C for the open/close direction; slotted hole with relief B for the cross direction.
- Positioning in the finger's cross direction**
Position the finger and the attachment by placing the finger's width into the attachment's finger insertion groove A.

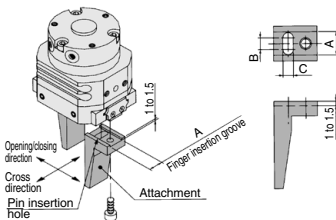

How to Mount the Attachment to the Finger

- To mount the attachment to the finger, make sure to use a wrench to support the attachment so as not to apply undue strain on the finger.
- Refer to the table below for the proper tightening torque on the bolt used for securing the attachment to the finger.

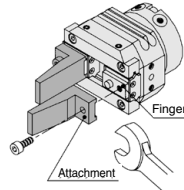

Model	Applicable bolt	Max. tightening torque N·m	
MHR	2 -10	M3 x 0.5	0.59
	-15		
	2 -20	M4 x 0.7	2.8
MDHR	3 -30	M5 x 0.8	5.9
	-10	M3 x 0.5	0.59
-15	1.4		

Finger opening/closing speed: MHR2/MHR3

When the finger opening/closing speed is set as the total stroke of 0.2 seconds or more, it may cause the product to stick or completely stop its movement.

Operating Environment

Caution

Use caution for the anti-corrosiveness of the cross roller section.

Martensitic stainless steel is used for the finger guide, so make sure that anti-corrosiveness is inferior to the austenitic stainless steel.

In particular, watch for rust in environments where waterdrops are likely to adhere due to condensation.

Lubrication/MHR2, MHR3

Warning

This product should be used without lubrication. If it is lubricated, it could lead to sticking or slipping.