

# Compact Rotary Actuator

## CRQ2 Series

Rack & Pinion Type/Size: 10, 15, 20, 30, 40

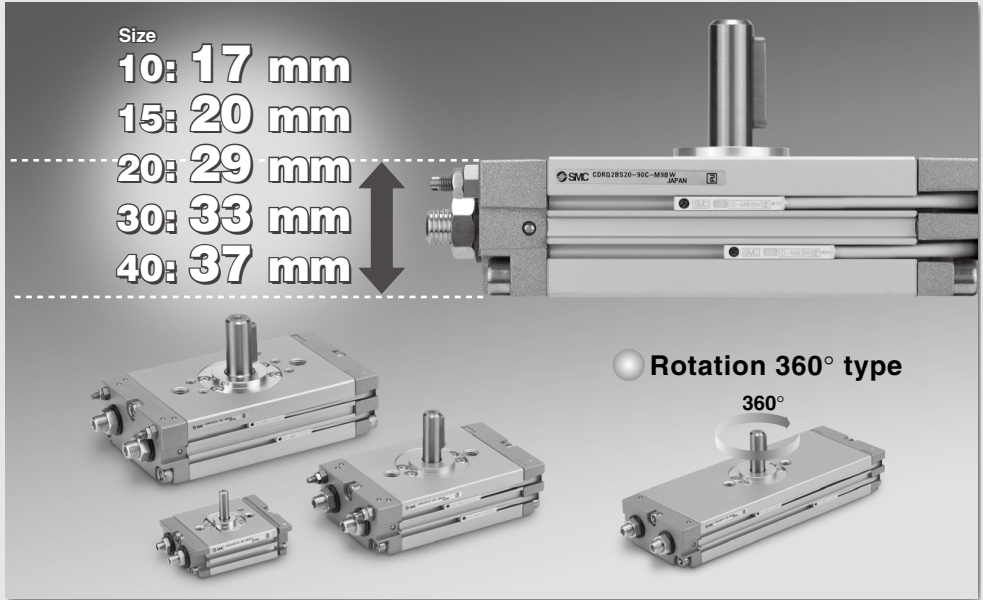

### Series Variations

		Size					Page	
		10	15	20	30	40		
Standard	Rotating angle	80° to 100°	●	●	●	●	P. 295 to P. 302	
		170° to 190° 350° to 370°	●	●	●	●		
	Shaft type	Single shaft	●	●	●	●		S
		Double shaft	●	●	●	●		
Cushion	Cushion	None	●	●	●	●		
		Rubber cushion	●	●	●	●		
		Air cushion	●	●	●	●		
Variations	Variations	With auto switch	●	●	●	●		
		Copper-free (Standard)	●	●	●	●		20-
Made to Order	Shaft type	Single shaft with four chamfers	●	●	●	●	P. 303, P. 304	
		Double shaft key	●	●	●	●		Y
		Double shaft with four chamfers	●	●	●	●		Z
		Single round shaft	●	●	●	●		T
		Double shaft (Without long shaft key)	●	●	●	●		J
		Double round shaft	●	●	●	●		K
Pattern	Pattern	Shaft end form	●	●	●	●	P. 306 to P. 320	
		Rotating range	●	●	●	●		
Shaft and parallel key stainless steel spec.			●	●	●	●	-X6	

# Compact Rotary Actuator

Rack & Pinion Type/Size: 10, 15, 20, 30, 40

## Built-in cushion

10, 15 : Rubber bumper  
20, 30, 40: Air cushion

Equipped with an angle adjusting mechanism ( $\pm 5^\circ$ )

Rotary actuator body serves as a flange.

360° type

360°

Piping can be installed from one end.

**CRQ2 Series**

2 auto switches are mountable on the same side.  
(Mountable on the both sides.)

Mounting smaller auto switches prevents the auto switch from protruding from the body edge and realizes space-savings.

Double piston type  
Compact, with no backlash

Both single shaft and double shaft are available in all sizes.

## 360° type application example

Complete external inspection of a work piece

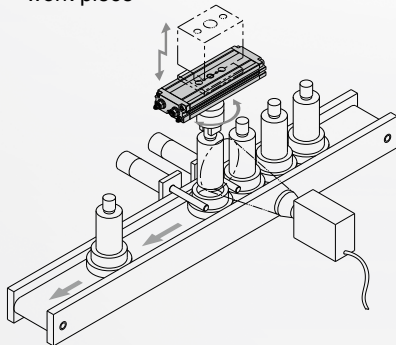

Centering is easy when mounting the main body.

Pin hole for positioning the main body

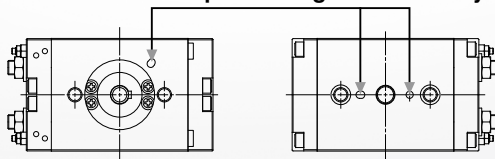

Size	Shaft type	Rotating angle	Cushion	
			Rubber	Air
10	<ul style="list-style-type: none"> <li>• Single</li> <li>• Double</li> </ul>	• 80° to 100°	●	—
15			●	—
20		• 170° to 190°	—	●
30			—	●
40		• 350° to 370°	—	●

# Compact Rotary Actuator Rack & Pinion Type **CRQ2 Series**

## How to Order

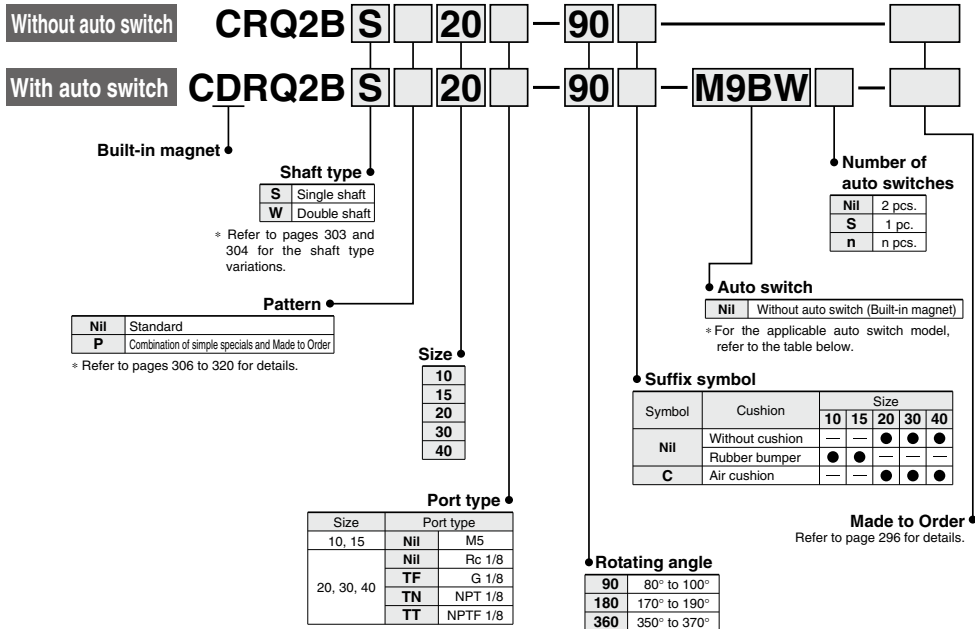

## Applicable Auto Switches

Refer to pages 929 to 983 for further information on auto switches.

Type	Special function	Electrical entry	Indicator light	Wiring (Output)	Load voltage		Auto switch model		Lead wire length (m)			Pre-wired connector	Applicable load			
					DC	AC	Perpendicular	In-line	0.5 (Nil)	1 (M)	3 (L)		5 (Z)	IC circuit	Relay, PLC	
																24 V
Solid state auto switch	—	Grommet	Yes	3-wire (NPN)	24 V	5 V, 12 V	—	M9NV	M9N	●	●	○	○	IC circuit	Relay, PLC	
				3-wire (PNP)				M9PV	M9P	●	●	○	○			
				2-wire	M9BV	M9B	●	●	○	○	—					
	3-wire (NPN)			M9NVW	M9NW	●	●	○	○	IC circuit						
	3-wire (PNP)			M9PVW	M9PW	●	●	○	○							
	2-wire			M9BWV	M9BW	●	●	○	○	—						
Water resistant (2-color)	—	Grommet	No	3-wire (NPN)	24 V	5 V, 12 V	—	M9NAV <sup>*1</sup>	M9NA <sup>*1</sup>	○	○	○	○	IC circuit	Relay, PLC	
				3-wire (PNP)				M9PAV <sup>*1</sup>	M9PA <sup>*1</sup>	○	○	○	○			
				2-wire	M9BAV <sup>*1</sup>	M9BA <sup>*1</sup>	○	○	○	○	—					
	3-wire (NPN equiv.)			24 V	12 V	100 V or less	A96V	A96	●	—	—	—	—	IC circuit		—
	2-wire						A93V <sup>*2</sup>	A93	●	●	●	—	—	—		
										A90V	A90	●	—	—		—

\*1 Although it is possible to mount water resistant type auto switches, note that the rotary actuator itself is not of water resistant construction.

\*2 1 m type lead wire is only applicable to D-A93.

\* Lead wire length symbols: 0.5 m ..... Nil (Example) M9NW  
1 m ..... M (Example) M9NWM  
3 m ..... L (Example) M9NWL  
5 m ..... Z (Example) M9NWZ

\* Auto switches marked with "○" are made to order specification.

\* Refer to pages 970 and 971 for the details of solid state auto switch with pre-wired connector.

\* Auto switches are shipped together, (but not assembled).

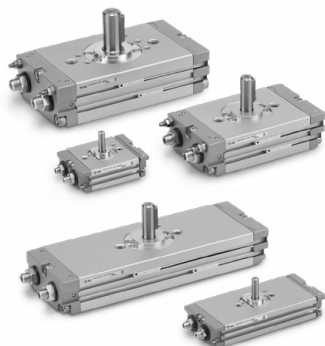

## Symbol



## Made to Order

Refer to pages 306 to 320 for details.

Symbol	Specifications/Content	Applicable shaft type
—	Shaft type variation	X, Y, Z, T, J, K
<b>XA1 to XA24</b>	Shaft pattern sequencing I	S, W
<b>XA31 to XA59</b>	Shaft pattern sequencing II	X, Y, Z, T, J, K
<b>XC7</b>	Reversed shaft	S, W, X, T, J
<b>XC8 to XC11</b>	Change of rotating range	S, W, Y X*, Z*, T*, J*, K*
<b>XC12 to XC15</b>	Change of angle adjustable range (0° to 100°)	
<b>XC16, XC17</b>	Change of angle adjustable range (90° to 190°)	
<b>XC18, XC19</b>	Change of rotating range	
<b>XC20, XC21</b>	Change of angle adjustable range (90° to 190°)	S, W, X, Y, Z, T, J, K
<b>XC22</b>	Without inner rubber bumper	
<b>XC30</b>	Fluorine grease	
<b>XC69</b>	Fluororubber seal	
<b>X6</b>	Shaft and parallel key made of stainless steel	

\* Among the symbols XC8 to XC21, only XC12 and XC16 are compatible with shaft types X, Z, T, J and K.

## Moisture Control Tube IDK Series



When operating an actuator with a small diameter and a short stroke at a high frequency, the dew condensation (water droplet) may occur inside the piping depending on the conditions.

Simply connecting the moisture control tube to the actuator will prevent dew condensation from occurring. For details, refer to [the Web Catalog](#).

## Specifications

Size	10	15	20	30	40
<b>Fluid</b>	Air (Non-lube)				
<b>Max. operating pressure</b>	0.7 MPa		1.0 MPa		
<b>Min. operating pressure</b>	0.15 MPa		0.1 MPa		
<b>Ambient and fluid temperature</b>	0° to 60°C (No freezing)				
<b>Cushion</b>	Rubber bumper		Not attached, Air cushion		
<b>Angle adjustment range</b>	Rotation end ±5°				
<b>Rotation</b>	90°, 180°, 360°				
<b>Port size</b>	M5 x 0.8		Rc 1/8, G 1/8, NPT 1/8, NPTF 1/8		
<b>Output (N·m)*</b>	0.3	0.75	1.8	3.1	5.3

\* Output under the operating pressure at 0.5 MPa. Refer to page 42 for further information.

## Allowable Kinetic Energy and Rotation Time Adjustment Range

Size	Allowable kinetic energy				Stable operational rotation time adjustment range
	Allowable kinetic energy (J)			Cushion angle	
	Without cushion	Rubber bumper	With air cushion*		Rotation time (s/90°)
<b>10</b>	—	0.00025	—	—	0.2 to 0.7
<b>15</b>	—	0.00039	—	—	0.2 to 0.7
<b>20</b>	0.025	—	0.12	40°	0.2 to 1
<b>30</b>	0.048	—	0.25	40°	0.2 to 1
<b>40</b>	0.081	—	0.4	40°	0.2 to 1

\* Allowable kinetic energy for the bumper equipped type  
Maximum absorbed energy under proper adjustment of the cushion needles.

If operated where the kinetic energy exceeds the allowable value, this may cause damage to the internal parts and result in product failure. Please pay special attention to the kinetic energy levels when designing, adjusting and during operation to avoid exceeding the allowable limit.

## Weight

Size	Standard weight* (g)		
	90°	180°	360°
<b>10</b>	120	150	200
<b>15</b>	220	270	380
<b>20</b>	600	700	1000
<b>30</b>	900	1100	1510
<b>40</b>	1400	1600	2280

\* Excluding the weight of auto switch.

## ⚠ Precautions

**Be sure to read this before handling the products.**  
Refer to page 7 for safety instructions, pages 8 to 13 for rotary actuator precautions, and pages 18 to 22 for auto switch precautions.

### ⚠ Caution

(1) The angle adjusting screw (angle adjustment bolt) is set at random near the maximum rotating angle. Therefore, it must be readjusted to obtain the angle that suits your application.

## Construction

### Basic type Size 10/15

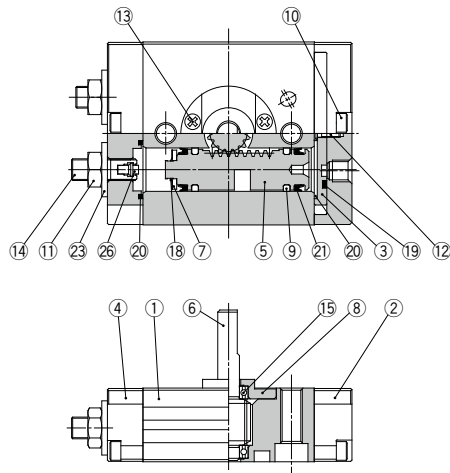

### Basic type Size 20/30/40

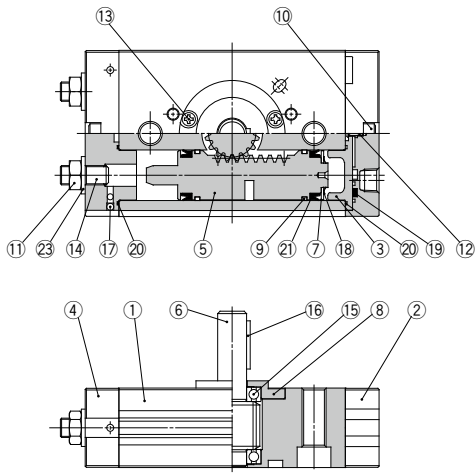

#### Component Parts

No.	Description	Material	Note
1	Body	Aluminum alloy	Anodized
2	Cover	Aluminum alloy	Chromated, painted
3	Plate	Aluminum alloy	Chromated
4	End cover	Aluminum alloy	Chromated, painted
5	Piston	Stainless steel	
6	Shaft	Stainless steel Chrome molybdenum steel	Size: 10, 15 Size: 20, 30, 40
7	Seal retainer	Aluminum alloy	Chromated
8	Bearing retainer	Aluminum alloy	Chromated
9	Wearing	Resin	
10	Hexagon socket head cap screw	Stainless steel	
11	Hexagon nut	Steel wire	Size: 10, 15
12	Small hexagon nut	Steel wire	Size: 20, 30, 40
13	Cross recessed No. 0 screw	Steel wire	Size: 10, 15
	Cross recessed screw	Steel wire	Size: 20, 30, 40

#### Component Parts

No.	Description	Material	Note
14	Hexagon socket head set screw	Chrome molybdenum steel	
15	Bearing	Bearing steel	
16	Parallel key	Carbon steel	Size: 20, 30, 40 only
17	Steel ball	Stainless steel	Size: 20, 30, 40 only
18	Type CS retaining ring	Stainless steel	
19	Seal	NBR	
20	Gasket	NBR	
21	Piston seal	NBR	
22	Cushion seal	Rubber material	Size: 20, 30, 40 only with cushion
23	Seal washer	NBR	
24	Magnet	—	With auto switch only
25	Cushion valve assembly		Size: 20, 30, 40 with cushion only
26	Cushion pad	Rubber material	Size: 10, 15

#### Replacement Parts

Description	Part no.				
	10	15	20	30	40
Seal kit	P473010-1	P473020-1	P473030-1	P473040-1	P473050-1

A grease pack (10 g) is included. When you need a grease pack only, order with the following part number.

Grease pack part no: GR-S-010 (10g)

Applicable parts	No.	Description	Qty.	Note
		19	Seal	1
		Gasket for cover	2	
	20	Gasket for endcover	1	Size: 10, 15
		Gasket	4	Size: 20, 30, 40
	21	Piston seal	4	
	23	Seal washer	2	

\* A set includes all parts above.

\* Individual part cannot be shipped.

# CRQ2 Series

## Construction

With auto switch  
Size 10/15

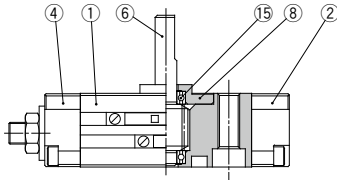
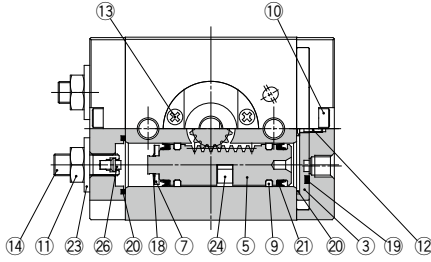

With auto switch  
Size 20/30/40

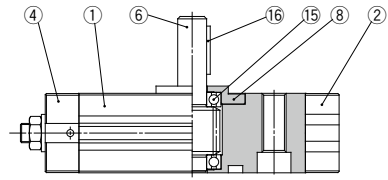
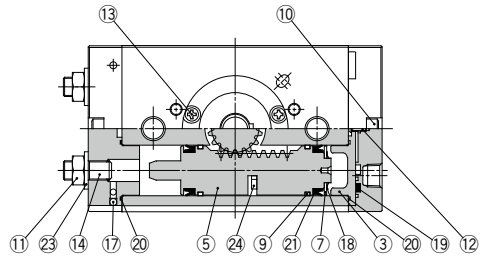

With cushion  
Size 20/30/40

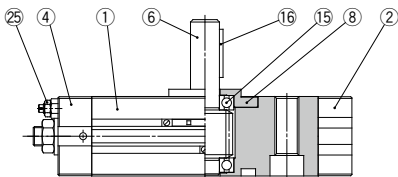
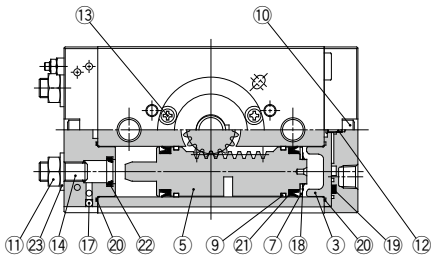

With auto switch and cushion  
Size 20/30/40

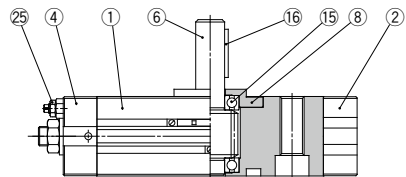
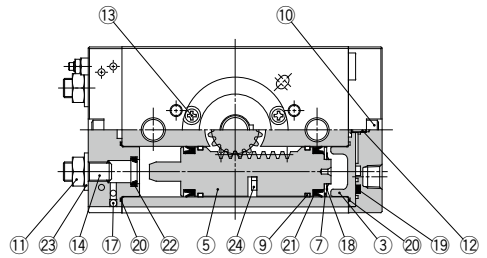

## Dimensions

### Size 10/15

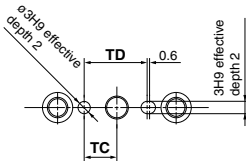
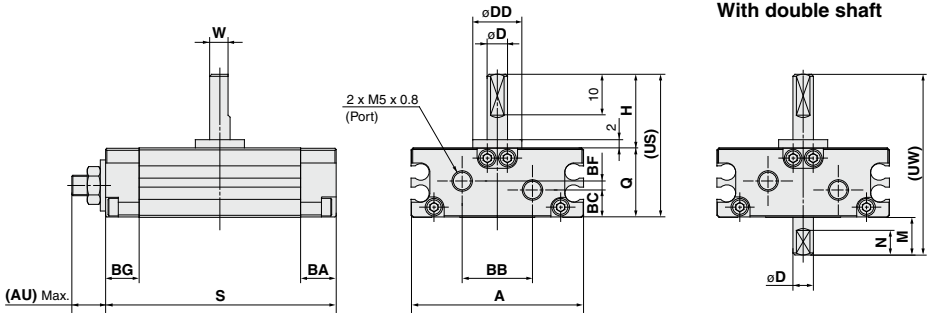
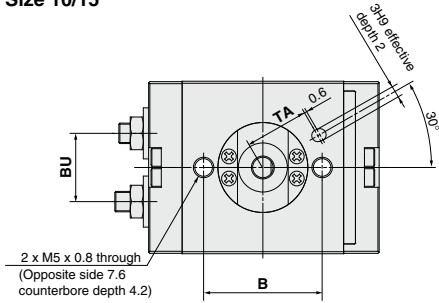

(mm)

Size	Rotating angle	A	AU*	B	BA	BB	BC	BF	BG	BU	D (g6)	DD (h9)	H
10	90°, 180°, 360°	42.4	(8.5)	29	8.7	17.2	6.7	2.2	8.2	16.7	5	12	18
15	90°, 180°, 360°	53.6	(9.5)	31	9.2	26.4	10.6	—	9	23.1	6	14	20

Size	Rotating angle	W	Q	S	US	UW	N	M	TA	TC	TD
10	90°	4.5	17	56.4	35	44	6	9	15.5	8	15.4
	180°			68.9							
	360°			96.9							
15	90°	5.5	20	65.2	40	50	7	10	16	9	17.6
	180°			82.2							
	360°			116.2							

\* AU dimension is not the dimension at the time of shipment, since its dimension is for adjustment parts.

S: Upper 90°, Middle 180°, Lower 360°

# CRQ2 Series

## Dimensions

### Size 20/30/40

These parts are not attached when a model without air cushion is selected.

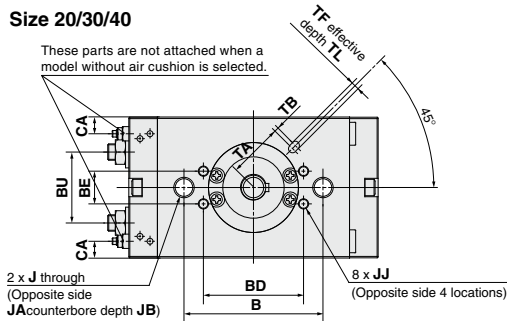

2 x J through (Opposite side JA counterbore depth JB)  
8 x JJ (Opposite side 4 locations)

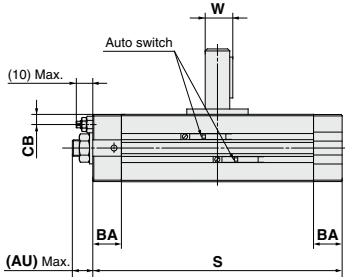

2 x Rc 1/8\*\* (Port)

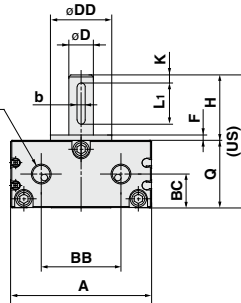

### With double shaft

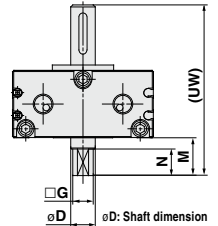

øD: Shaft dimension

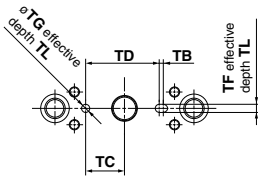

Size	Rotating angle	A	AU*	B	BA	BB	BC	BD	BE	BU	CA	CB	D (g6)	DD (h9)	F	H	J	JA	JB
20	90°, 180°, 360°	63	(11)	50	14	34	14.5	—	—	30.4	7	5	10	25	2.5	30	M 8 x 1.25	11	6.5
30	90°, 180°, 360°	69	(11)	68	14	39	16.5	49	16	34.7	8.1	5.3	12	30	3	32	M10 x 1.5	14	8.5
40	90°, 180°, 360°	78	(13)	76	16	47	18.5	55	16	40.4	8.3	5.5	15	32	3	36	M10 x 1.5	14	8.6

Size	Rotating angle	JJ	K	Q	S	W	Key dimensions		US	TA	TB	TC	TD	TF (H9)	TG (H9)	TL	UW	G	M	N	L
							b	L1													
20	90°	—	3	29	104.4	11.5	4 <sup>0</sup> <sub>-0.03</sub>	20	59	24.5	1	13.5	27	4	4	2.5	74	8 <sup>0</sup> <sub>-0.1</sub>	15	11	9.6 <sup>0</sup> <sub>-0.1</sub>
	180°				129.5																
	360°				179.8																
30	90°	M5 x 0.8 depth 6	4	33	122	13.5	4 <sup>0</sup> <sub>-0.03</sub>	20	65	27	2	19	36	4	4	2.5	83	10 <sup>0</sup> <sub>-0.1</sub>	18	13	11.4 <sup>0</sup> <sub>-0.1</sub>
	180°				153																
	360°				216																
40	90°	M6 x 1 depth 7	5	37	139.3	17	5 <sup>0</sup> <sub>-0.03</sub>	25	73	32.5	2	20	39.5	5	5	3.5	93	11 <sup>0</sup> <sub>-0.1</sub>	20	15	14 <sup>0</sup> <sub>-0.1</sub>
	180°				177																
	360°				253																

\* AU dimension is not the dimension at the time of shipment, since its dimension is for adjustment parts.

\*\* In addition to Rc 1/8, G 1/8, NPT 1/8, NPTF 1/8 are also available.

S: Upper 90°, Middle 180°, Lower 360°



## Rotation Range

When the pressure is applied from the A port, the shaft will rotate in a clockwise direction.

### Rotating angle: 90°

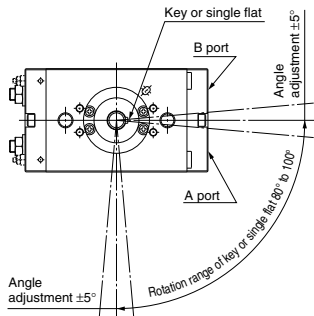

### Rotating angle: 180°

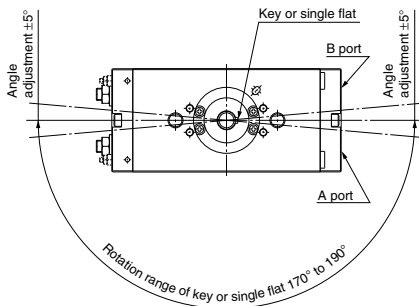

### Rotating angle: 360°

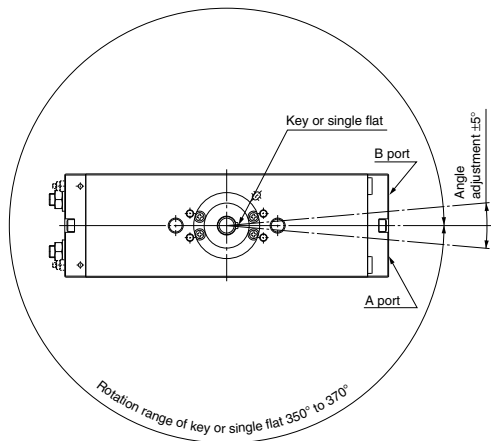

# CRQ2 Series

## Unit Used as Flange Mount

The L dimensions of this unit are shown in the table below. When hexagon socket head cap bolt of the JIS standard is used, the head of the bolt will recess into the groove of actuator.

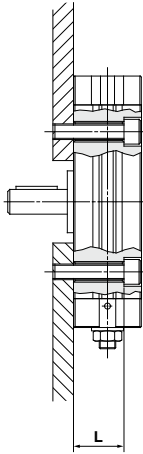

Size	L	Screw
10	13	M4
15	16	M4
20	22.5	M6
30	24.5	M8
40	28.5	M8

## Auto Switch Proper Mounting Position at Rotation End

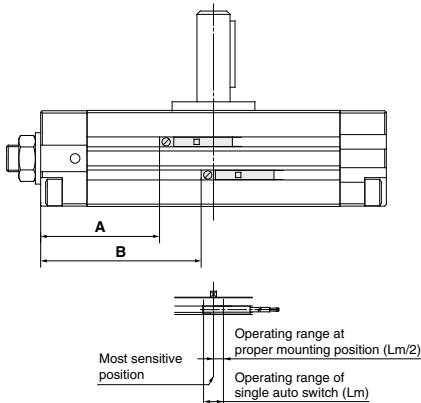

Size	Rotating angle	Solid state switch				Reed switch			
		A	B	Operating angle (θ m)	Hysteresis angle	A	B	Operating angle (θ m)	Hysteresis angle
10	90°	19	25.5	61°	5°	15	21.5	63°	12°
	180°	22	35			18	31		
	360°	29	56.5			25	52.5		
15	90°	22.5	31	47°	4°	18.5	27	52°	9°
	180°	26.5	43.5			22.5	39.5		
	360°	34.5	68.5			30.5	64.5		
20	90°	40	52.5	40°	4°	36	48.5	41°	9°
	180°	46	71.5			42	67.5		
	360°	59.5	110			55.5	106		
30	90°	47	63	29°	2°	43	59	32°	7°
	180°	55	86			51	82		
	360°	66	129.5			62	125.5		
40	90°	54	73	24°	2°	50	69	24°	5°
	180°	63.5	101.5			59.5	97.5		
	360°	76.5	156			72.5	152		

Operating angle θ m: The value of the individual switch's movement range Lm as represented by an angle.

Hysteresis angle: Value of the switch's hysteresis as represented by an angle.

Note) Since the above values are only provided as a guideline, they are not guaranteed. In the actual setting, adjust them after confirming the auto switch performance.

## 1 Shaft Type Variation, Four Chamfers (Size 20/30/40)

Shaft Type: X, Z

C RQ2B  
CDRQ2B

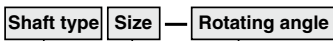

Refer to "How to Order" on page 295 for further information.

Shaft type

X	Single shaft with four chamfers
Z	Double shaft with four chamfers

### Specifications

Fluid	Air (Non-lube)
Applicable shaft type	Single w/ four chamfers (X), Double w/ four chamfers (Z)
Applicable size	20, 30, 40
Max. operating pressure	1.0 MPa
Min. operating pressure	0.1 MPa
Cushion	Not attached, Air cushion
Rotation	80° to 100°, 170° to 190°, 350° to 370°
Port size	Rc 1/8, G 1/8, NPT 1/8, NPTF 1/8
Auto switch	Mountable

### Dimensions

Shaft type	X				Z			
Form								
Size	D (g6)	G	H	N	UX	UZ	M	
20	10	8 <sup>+0</sup> <sub>-0.1</sub>	21	11	50	65	15	
30	12	10 <sup>+0</sup> <sub>-0.1</sub>	24	13	57	75	18	
40	15	11 <sup>+0</sup> <sub>-0.1</sub>	27	15	64	84	20	

(mm)

Note) Dimension parts different from the standard conform to the general tolerance.

## 2 Shaft Type Variation, Double Shaft With Key (Size 20/30/40)

Shaft Type: Y

C RQ2B  
CDRQ2B



Refer to "How to Order" on page 295 for further information.

Shaft type

Y	Double shaft with key
---	-----------------------

### Dimensions

Y					
Size	D (g6)	W	H	UY	
20	10	11.5	30	89	
30	12	13.5	32	97	
40	15	17	36	109	

(mm)

### Specifications

Fluid	Air (Non-lube)
Applicable shaft type	Double shaft with key (Y)
Applicable size	20, 30, 40
Max. operating pressure	1.0 MPa
Min. operating pressure	0.1 MPa
Cushion	Not attached, Air cushion
Rotating angle	80° to 100°, 170° to 190°, 350° to 370°
Port size	Rc 1/8, G 1/8, NPT 1/8, NPTF 1/8
Auto switch	Mountable

Note) Dimension parts different from the standard conform to the general tolerance.

## 3 Shaft Type Variation/Without Keyway

Shaft Type: T, J, K

C RQ2B  
CDRQ2B

Shaft type    Size    Rotating angle

● Shaft type  
● Refer to "How to Order" on page 295 for further information.

T	Single round shaft
J	Double shaft ( Without long shaft key, with four chamfers on short shaft, one chamfer on short shaft for 10 and 15. )
K	Double round shaft

### Specifications

Fluid	Air (Non-lube)	
Applicable shaft type	Single round shaft (T), Double shaft (J), Double round shaft (K)	
Applicable size	10, 15	20, 30, 40
Max. operating pressure	0.7 MPa	1.0 MPa
Min. operating pressure	0.15 MPa	0.1 MPa
Cushion	Rubber bumper	Not attached, Air cushion
Rotating angle	80° to 100°, 170° to 190°, 350° to 370°	
Port size	M5 x 0.8	Rc 1/8, G 1/8, NPT 1/8, NPTF 1/8
Auto switch	Mountable	

### Dimensions

Shaft type	T				J				K	
Form										
	Size 10, 15				Size 20, 30, 40					
Size	D (g6)	G	W	H	M	N	UT	UJ	UK	
10	5	—	4.5	18	9	6	35	44	53	
15	6	—	5.5	20	10	7	40	50	60	
20	10	8 <sup>+0</sup> <sub>-0.1</sub>	—	30	15	11	59	74	89	
30	12	10 <sup>+0</sup> <sub>-0.1</sub>	—	32	18	13	65	83	97	
40	15	11 <sup>+0</sup> <sub>-0.1</sub>	—	36	20	15	73	93	109	

Note) Dimension parts different from the standard conform to the general tolerance.





**Shaft Pattern Sequencing I**

Symbol

**-XA1 to XA8**

**Additional Reminders**

1. Enter the dimensions within a range that allows for additional machining.
2. Unless indicated otherwise, the dimensional tolerance conforms to the general tolerance. SMC will make appropriate arrangements.
3. The length of the unthreaded portion is 2 to 3 pitches.
4. Unless specified otherwise, the thread pitch is based on coarse metric threads.  
M3 x 0.5, M4 x 0.7, M5 x 0.8  
M6 x 1
5. Enter the desired figures in the  portion of the diagram.
6. XA1 to XA24 are the standard products that have been additionally machined.
7. Chamfer face of the parts machining additionally is C0.5.

**Symbol: A1**

Machine female threads into the long shaft.  
The maximum dimension L1 is, as a rule, twice the thread size (Example) For M3: L1 = 6  
• Applicable shaft types: S, W

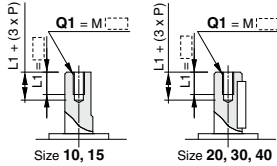

Size	Q1
10	M3
15	M3, M4
20	M3, M4
30	M3, M4, M5
40	M4, M5, M6

**Symbol: A2**

Machine female threads into the short shaft.  
The maximum dimension L2 is, as a rule, twice the thread size. (Example) For M4: L2 = 8  
• Applicable shaft types: S, W

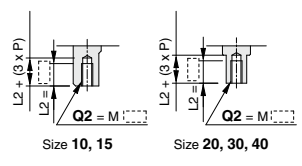

Size	Q2
10	M3
15	M3, M4
20	M3, M4
30	M3, M4, M5
40	M4, M5, M6

**Symbol: A3**

The long shaft can be further shortened by machining male threads into it.  
(If shortening the shaft is not required, indicate "\*" for dimension X.)  
• Applicable shaft types: S, W

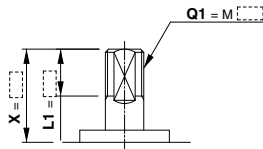

Size	X	L1 max	Q1
10	9 to 18	X - 4	M5
15	10 to 20	X - 4	M6

**Symbol: A4**

The short shaft can be further shortened by machining male threads into it.  
(If shortening the shaft is not required, indicate "\*" for dimension Y.)  
• Applicable shaft type: W

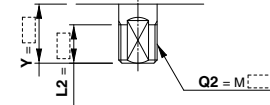

Size	Y	L2 max	Q2
10	7 to 9	Y - 2	M5
15	8 to 10	Y - 3	M6

**Symbol: A5**

The long shaft can be further shortened by machining it into a stepped round shaft.  
(If shortening the shaft is not required, indicate "\*" for dimension X.)  
(If not specifying dimension C1, indicate "\*" instead.)  
• Applicable shaft types: S, W  
• Equal dimensions are indicated by the same marker.

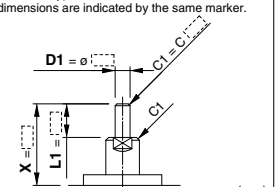

Size	X	L1 max	D1
10	3 to 18	X - 2	ø3.5 to ø4.9
15	3 to 20	X - 2	ø3.5 to ø5.9

**Symbol: A6**

The short shaft can be further shortened by machining it into a stepped round shaft.  
(If shortening the shaft is not required, indicate "\*" for dimension Y.)  
(If not specifying dimension C2, indicate "\*" instead.)  
• Applicable shaft type: W  
• Equal dimensions are indicated by the same marker.

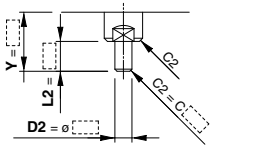

Size	Y	L2 max	D2
10	1 to 9	Y	ø3.5 to ø4.9
15	1 to 10	Y	ø3.5 to ø5.9

**Symbol: A7**

The long shaft can be further shortened by machining it into a stepped round shaft with male threads.  
(If shortening the shaft is not required, indicate "\*" for dimension X.)  
(If not specifying dimension C1, indicate "\*" instead.)  
• Applicable shaft types: S, W

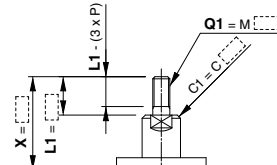

Size	X	L1 max	Q1
10	8 to 18	X - 2	M3, M4
15	9.5 to 20	X - 2	M3, M4, M5

**Symbol: A8**

The short shaft can be further shortened by machining it into a stepped round shaft with male threads.  
(If shortening the shaft is not required, indicate "\*" for dimension Y.)  
(If not specifying dimension C2, indicate "\*" instead.)  
• Applicable shaft type: W

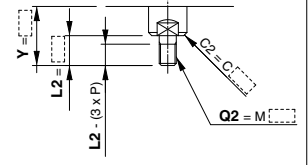

Size	Y	L2 max	Q2
10	6 to 9	Y	M3, M4
15	7.5 to 10	Y	M3, M4, M5

## Shaft Pattern Sequencing I

Symbol

**-XA9 to XA16**

### Additional Reminders

1. Enter the dimensions within a range that allows for additional machining.
2. Unless indicated otherwise, the dimensional tolerance conforms to the general tolerance. SMC will make appropriate arrangements.
3. The length of the unthreaded portion is 2 to 3 pitches.
4. Unless specified otherwise, the thread pitch is based on coarse metric threads.  
M3 x 0.5, M4 x 0.7, M5 x 0.8  
M6 x 1
5. Enter the desired figures in the  $\square$  portion of the diagram.
6. XA9 to XA24 are the standard products that have been additionally machined.
7. Chamfer face of the parts machining additionally is C0.5.

### Symbol: A9

The long shaft can be further shortened by changing the length of the standard chamfer on the long shaft side. (If shortening the shaft is not required, indicate "\*" for dimension X.)

- Applicable shaft types: S, W

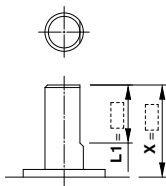

Size	X	L1
10	8 to 18	$\{10 - (18 - X)\}$ to $(X - 2)$
15	10 to 20	$\{10 - (20 - X)\}$ to $(X - 2)$

### Symbol: A10

The short shaft can be further shortened by changing the length of the standard chamfer.

- Applicable shaft type: W

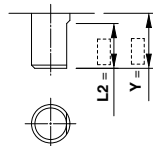

Size	Y	L2
10	3 to 9	$6 - (9 - Y)$ to Y
15	3 to 10	$7 - (10 - Y)$ to Y

### Symbol: A11

The long shaft can be further shortened by machining a double-sided chamfer on it.

- Since L1 is a standard chamfer, dimension E1 is 0.5 or more.

(If altering the standard chamfer and shortening the shaft are not required, indicate "\*" for both the L1 and X dimensions.)

- Applicable shaft types: S, W

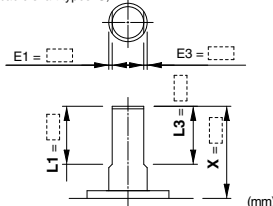

Size	X	L1	L3 max
10	8 to 18	$\{10 - (18 - X)\}$ to $(X - 2)$	X - 2
15	10 to 20	$\{10 - (20 - X)\}$ to $(X - 2)$	X - 2

### Symbol: A12

The short shaft can be further shortened by machining a double-sided chamfer on it.

- Since L2 is a standard chamfer, dimension E2 is 0.5 or more.

(If altering the standard chamfer and shortening the shaft are not required, indicate "\*" for both the L2 and Y dimensions.)

- Applicable shaft type: W

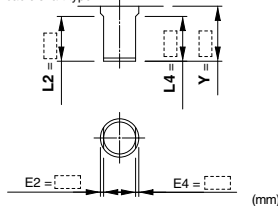

Size	Y	L2	L4 max
10	3 to 9	$6 - (9 - Y)$ to Y	Y
15	3 to 10	$7 - (10 - Y)$ to Y	Y

### Symbol: A13

Shaft with through-hole  
Minimum machining diameter for d1 is 0.1.

- Applicable shaft types: S, W

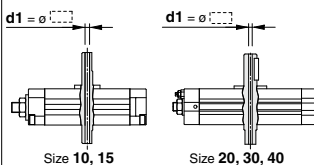

Size	d1
10	ø2 to ø3
15	ø2 to ø4
20	ø2.5 to ø3.5
30	ø3 to ø5.5
40	ø4 to ø7

### Symbol: A14

A special end is machined onto the long shaft, and a through-hole is drilled into it. Female threads are machined into the through-hole, whose diameter is equivalent to the pilot hole diameter.

- The maximum dimension L1 is, as a rule, twice the thread size.

- (Example) For M3: L1 = 6
- Applicable shaft types: S, W

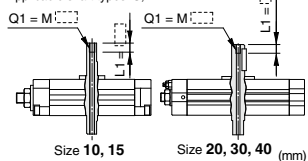

Size	10	15	20	30	40
Thread	—	—	—	—	—
M3 x 0.5	ø2.5	ø2.5	ø2.5	—	—
M4 x 0.7	—	ø3.3	ø3.3	ø3.3	—
M5 x 0.8	—	—	—	ø4.2	ø4.2
M6 x 1	—	—	—	—	ø5

### Symbol: A15

A special end is machined onto the short shaft, and a through-hole is drilled into it. Female threads are machined into the through-hole, whose diameter is equivalent to the pilot hole diameter.

- The maximum dimension L2 is, as a rule, twice the thread size. (Example) For M4: L2 = 8

- Applicable shaft types: S, W

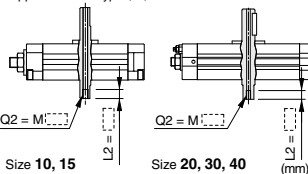

Size	10	15	20	30	40
Thread	—	—	—	—	—
M3 x 0.5	ø2.5	ø2.5	ø2.5	—	—
M4 x 0.7	—	ø3.3	ø3.3	—	—
M5 x 0.8	—	—	—	ø4.2	ø4.2
M6 x 1	—	—	—	—	ø5

### Symbol: A16

A special end is machined onto both the long and short shafts, and a through-hole is drilled into both shafts. Female threads are machined into the through-holes, whose diameter is equivalent to the diameter of the pilot holes.

- The maximum dimension L1 is, as a rule, twice the thread size. (Example) For M5: L1 = 10

- Applicable shaft types: S, W

- Equal dimensions are indicated by the same marker.

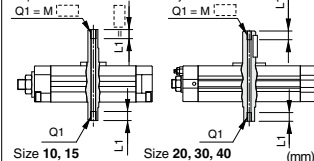

Size	10	15	20	30	40
Thread	—	—	—	—	—
M3 x 0.5	ø2.5	ø2.5	ø2.5	—	—
M4 x 0.7	—	ø3.3	ø3.3	ø3.3	—
M5 x 0.8	—	—	—	ø4.2	ø4.2
M6 x 1	—	—	—	—	ø5



Symbol

**-XA17 to XA24**

## Shaft Pattern Sequencing I

### Symbol: **A17**

Shorten the long shaft.  
 • Applicable shaft types: S, W

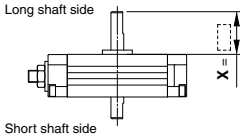

Size	X (mm)
10	2 to 18
15	2 to 20
20	17 to 30
30	18 to 32
40	18.5 to 36

### Symbol: **A18**

Shorten the short shaft.  
 • Applicable shaft type: W

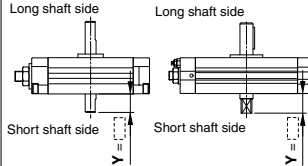

Size	Y (mm)
10, 15	1 to 9
20	1 to 10
30	1 to 18
40	1 to 20

### Symbol: **A19**

Both the long shaft and short shaft are shortened.  
 • Applicable shaft type: W

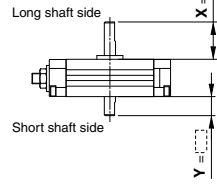

Size	X (mm)	Y (mm)
10	2 to 18	1 to 9
15	2 to 20	1 to 10
20	17 to 30	1 to 15
30	18 to 32	1 to 18
40	18.5 to 36	1 to 20

### Symbol: **A20**

Reverse the assembly of the shaft. (Thus shortening the long end and the short end of the shaft.)  
 (If shortening the shaft is not required, indicate "\*" for dimension X and Y.)

• Applicable shaft types: S, W

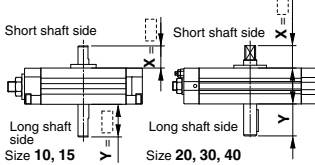

Size	X (mm)	Y (mm)
10	2 to 10	1 to 17
15	2 to 11	1 to 19
20	2.5 to 16.5	16 to 28.5
30	3 to 20	16 to 30
40	3 to 22	16.5 to 34

### Symbol: **A21**

The long shaft can be further shortened by machining it into a stepped round shaft with a double-sided chamfer.  
 (If shortening the shaft is not required, indicate "\*" for dimension X.) (If not specifying dimension C1, indicate "\*" instead.)

• Applicable shaft types: S, W  
 • Equal dimensions are indicated by the same marker.

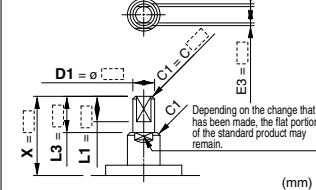

Size	X	L1 max	L3	D1
10	5 to 18	X - 3.5	L1 + 1.5	ø3.5 to ø4.9
15	5.5 to 18	X - 4	L1 + 2	ø3.5 to ø5.9

### Symbol: **A22**

The short shaft can be further shortened by machining it into a stepped round shaft with a double-sided chamfer.  
 (If shortening the shaft is not required, indicate "\*" for dimension Y.)  
 (If not specifying dimension C2, indicate "\*" instead.)

• Applicable shaft type: W  
 • Equal dimensions are indicated by the same marker.

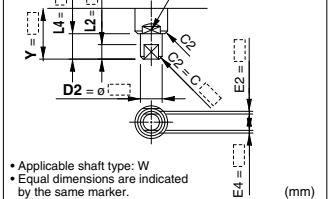

Size	Y	L2 max	L4	D2
10	3 to 9	Y - 1.5	L1 + 1.5	ø3.5 to ø4.9
15	3.5 to 10	Y - 2	L1 + 2	ø3.5 to ø5.9

### Symbol: **A23**

The long shaft can be further shortened by machining right-angle double-sided chamfer onto it.

• Since L1 is a standard chamfer, dimension E1 is 0.5 or more.

(If altering the standard chamfer and shortening the shaft are not required, indicate "\*" for both the L1 and X dimensions.)

• Applicable shaft types: S, W

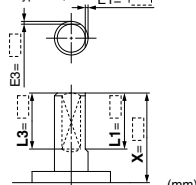

Size	X	L1	L3 max
10	8 to 18	{10 - (18 - X)} to {X - 2}	X - 2
15	10 to 20	{10 - (20 - X)} to {X - 2}	X - 2

### Symbol: **A24**

Double key  
 Keys and keyways are machined at 180° from the standard position.

• Applicable shaft types: S, W  
 • Equal dimensions are indicated by the same marker.

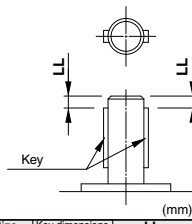

Size	Key dimensions	LL (mm)
20	4 x 4 x 20	3
30	4 x 4 x 20	4
40	5 x 5 x 25	5

# CRQ2 Series (Size: 10, 15, 20, 30, 40)

## Simple Specials:

# -XA31 to -XA59: Shaft Pattern Sequencing II

Shaft shape pattern is dealt with through the Simple Specials System.  
Please contact your local sales representative for more details.

Symbol

**-XA31 to XA59**

## Shaft Pattern Sequencing II

Applicable shaft type: X, Y, Z, T, J and K

### How to Order



#### Built-in magnet

Nil	None
D	Built-in magnet

#### Shaft type

X	Single shaft with four chamfers
Y	Double shaft key
Z	Double shaft with four chamfers
T	Single round shaft
J	Double shaft
K	Double round shaft

\* Refer to pages 303 and 304 for the shaft type variations.

#### Size

10
15
20
30
40

#### Auto switch

Refer to page 295 for "How to Order" products with auto switches.

#### Air cushion

Size	Air cushion	
	None	Attached
10, 15	Nil	—
20, 30, 40	—	C

#### Rotating angle

90	80° to 100°
180	170° to 190°
360	350° to 370°

#### Symbol for simple specials, Made-to-Order products

- When number of combinations is 1 or 2, refer to chart 3 and 4.
- \* Combination of XA is possible for up to 2 types.
- \* Combination of -X6 (shaft, parallel key stainless spec) is available for all the types.

#### Combination 3 Types

A33	A34	C30
A34	A37	-X6
A35	C30	C69
A40	C8	-X6

#### Combination of Applicable Chart

Chart 3, 4
Chart 3
Chart 4, 5
Chart 4, 5

Combination is available only when all the conditions are fulfilled among the nation chart above.

#### Combination 4 Types

A33	A34	C30	C69
A34	A37	C12	-X6
A43	C12	C30	-X6

#### Combination of Applicable Chart

Chart 3, 4, 5
Chart 3, 4
Chart 4, 5

Combination is available only when all the conditions are fulfilled among the nation chart above.

\* Combination of simple specials and Made-to-Order, it is possible for up to 4 types.

#### Pattern

#### How to order model with auto switches

Refer to page 295 for "How to Order" products with auto switches.

#### Thread type

Size	Port type	
10, 15	Nil	M5
20, 30, 40	Nil	Rc 1/8
	TF	G 1/8
	TN	NPT 1/8
	TT	NPTF 1/8



## Shaft Pattern Sequencing II

Symbol

-XA31 to XA38

### Additional Reminders

1. Enter the dimensions within a range that allows for additional machining.
2. Unless indicated otherwise, the dimensional tolerance conforms to the general tolerance. SMC will make appropriate arrangements.
3. The length of the unthreaded portion is 2 to 3 pitches.
4. Unless specified otherwise, the thread pitch is based on coarse metric threads.  
M3 x 0.5, M4 x 0.7, M5 x 0.8  
M6 x 1
5. Enter the desired figures in the  portion of the diagram.
6. XA31 to XA59 are the standard products that have been additionally machined.
7. Chamfer face of the parts machining additionally is C0.5.

### Symbol: A31

Machine female threads into the long shaft.  
 • The maximum dimension L1 is, as a rule, twice the thread size.  
 (Example) For M3: L1 = 6  
 • Applicable shaft type: Y

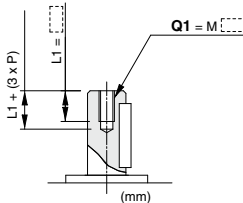

Size	Q1
20	M3, M4
30	M3, M4, M5
40	M4, M5, M6

### Symbol: A32

Machine female threads into the short shaft.  
 • The maximum dimension L2 is, as a rule, twice the thread size.  
 (Example) For M4: L2 = 8  
 • Applicable shaft type: Y

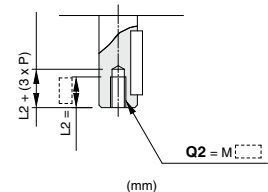

Size	Q2
20	M3, M4
30	M3, M4, M5
40	M4, M5, M6

### Symbol: A33

Machine female threads into the long shaft.  
 • The maximum dimension L1 is, as a rule, twice the thread size.  
 (Example) For M3: L1 = 6  
 • Applicable shaft types: J, K, T

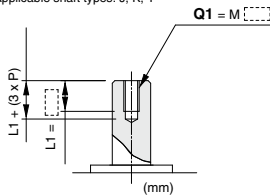

Size	Q1
10	M3
15	M3, M4
20	M3, M4, M5, M6
30	M4, M5, M6, M8
40	M4, M5, M6, M8, M10

### Symbol: A34

Machine female threads into the short shaft.  
 • The maximum dimension L2 is, as a rule, twice the thread size.  
 (Example) For M5: L2 = 10  
 • Applicable shaft types: K, T, X

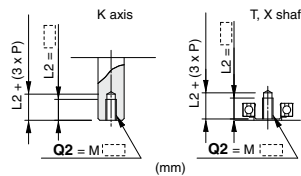

Size	Q2
10	M3
15	M3, M4
20	M3, M4, M5, M6
30	M4, M5, M6, M8
40	M4, M5, M6, M8, M10

### Symbol: A35

Machine female threads into the long shaft.  
 • The maximum dimension L1 is, as a rule, twice the thread size.  
 (Example) For M3: L1 = 6  
 • Applicable shaft types: X, Z

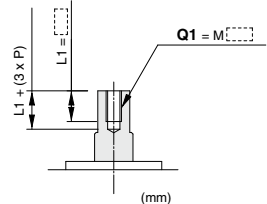

Size	Q1
20	M3, M4
30	M3, M4, M5, M6
40	M4, M5, M6, M8

### Symbol: A36

Machine female threads into the short shaft.  
 • The maximum dimension L2 is, as a rule, twice the thread size.  
 (Example) For M4: L2 = 8  
 • Applicable shaft types: J, Z

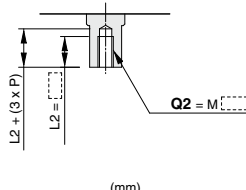

Size	Q2
20	M3, M4
30	M3, M4, M5, M6
40	M4, M5, M6, M8

### Symbol: A37

The long shaft can be further shortened by machining it into a stepped round shaft. (If shortening the shaft is not required, indicate "∞" for dimension X.) (If not specifying dimension C1, indicate "∞" instead.)  
 • Applicable shaft types: J, K, T  
 • Equal dimensions are indicated by the same marker.

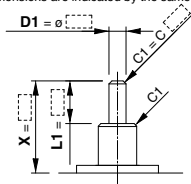

Size	X	L1 max	D1
10	3 to 18	X - 2	ø3.5 to ø4.9
15	3 to 20	X - 2	ø3.5 to ø5.9
20	3.5 to 30	X - 2.5	ø5 to ø9.9
30	4 to 32	X - 3	ø5 to ø11.9
40	4 to 36	X - 3	ø5 to ø14.9

### Symbol: A38

The short shaft can be further shortened by machining it into a stepped round shaft. (If shortening the shaft is not required, indicate "∞" for dimension Y.) (If not specifying dimension C2, indicate "∞" instead.)  
 • Applicable shaft type: K  
 • Equal dimensions are indicated by the same marker.

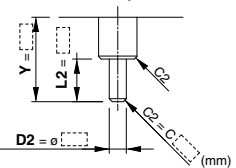

Size	Y	L2 max	D2
10	1 to 18	Y	ø3.5 to ø4.9
15	1 to 20	Y	ø3.5 to ø5.9
20	1 to 30	Y	ø5 to ø9.9
30	1 to 32	Y	ø5 to ø11.9
40	1 to 36	Y	ø5 to ø14.9

**Shaft Pattern Sequencing II**

Symbol

**-XA39 to XA48**

**Symbol: A39**

Shaft with through-hole  
Minimum machining diameter for d1 is 0.1.  
• Applicable shaft type: Y

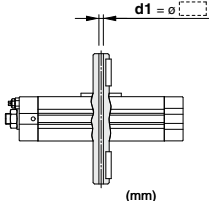

Size	d1
20	ø2.5 to ø3.5
30	ø3 to ø5.5
40	ø4 to ø7

**Symbol: A40**

Shaft with through-hole  
Minimum machining diameter for d1 is 0.1.  
• Applicable shaft types: K, T

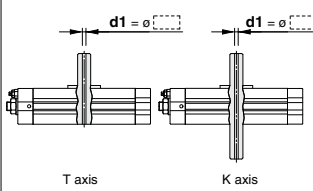

Size	d1
10	ø2 to ø3
15	ø2 to ø4
20	ø2.5 to ø6
30	ø3 to ø8
40	ø4 to ø10

**Symbol: A41**

Shaft with through-hole  
Minimum machining diameter for d1 is 0.1.  
• Applicable shaft types: J, X, Z

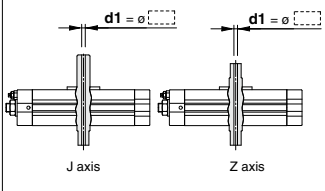

Size	d1
10	ø2 to ø3
15	ø2 to ø4
20	ø2.5 to ø5
30	ø3 to ø7
40	ø4 to ø8

**Symbol: A42**

A special end is machined onto both the long and short shafts, and a through-hole is drilled into both shafts. Female threads are machined into the through-holes, whose diameter is equivalent to the diameter of the pilot holes.

- The maximum dimension L1 is, as a rule, twice the thread size.
- Applicable shaft type: Y
- Equal dimensions are indicated by the same marker.

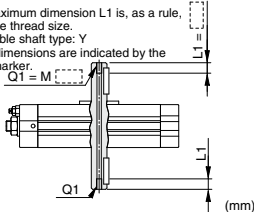

Size	20	30	40
Thread	M3 x 0.5	M4 x 0.7	M5 x 0.8
Q1	ø2.5	ø3.3	ø4.2
L1	—	—	—
W1	—	—	—

**Symbol: A43**

A special end is machined onto both the long and short shafts, and a through-hole is drilled into both shafts. Female threads are machined into the through-holes, whose diameter is equivalent to the diameter of the pilot holes.

- The maximum dimension L1 is, as a rule, twice the thread size.
- Applicable shaft types: K, T
- Equal dimensions are indicated by the same marker.

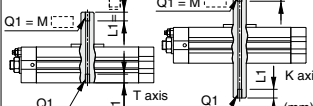

Size	10	15	20	30	40
Thread	M3 x 0.5	M4 x 0.7	M5 x 0.8	M6 x 1	M8 x 1.25
Q1	ø2.5	ø3.3	ø4.2	ø5	ø6.8
L1	—	—	—	—	—
W1	—	—	—	—	—
Surface	Rc 1/8	—	—	—	—

**Symbol: A44**

A special end is machined onto both the long and short shafts, and a through-hole is drilled into both shafts. Female threads are machined into the through-holes, whose diameter is equivalent to the diameter of the pilot holes.

- The maximum dimension L1 is, as a rule, twice the thread size.
- Applicable shaft types: J, X, Z
- Equal dimensions are indicated by the same marker.

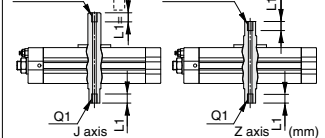

Size	10	15	20	30	40
Thread	M3 x 0.5	M4 x 0.7	M5 x 0.8	M6 x 1	M8 x 1.25
Q1	ø2.5	ø3.3	ø4.2	ø5	ø6.8
L1	—	—	—	—	—
W1	—	—	—	—	—

**Symbol: A45**

The long shaft can be further shortened by machining a middle-cut chamfer into it. (If shortening the shaft is not required, indicate "s" for dimension X.) (The position is that of the standard flat at the keyway portion.)

- Applicable shaft types: J, K, T

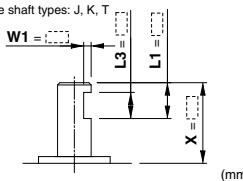

Size	X	W1	L1 max	L3 max
10	6 to 18	0.5 to 1.5	X-2	L1-1
15	6.5 to 20	0.5 to 1.5	X-2	L1-1
20	9.5 to 30	1 to 2	X-2.5	L1-2
30	11.5 to 32	1 to 2	X-3	L1-2
40	12.5 to 36	1 to 2	X-3	L1-2

**Symbol: A46**

The short shaft can be further shortened by machining a middle-cut chamfer into it. (If shortening the shaft is not required, indicate "s" for dimension Y.) (The position is that of the standard flat at the keyway portion.)

- Applicable shaft type: K

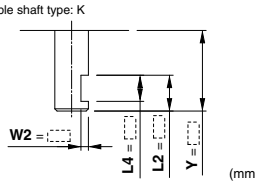

Size	Y	W2	L2 max	L4 max
10	4 to 18	0.5 to 1.5	Y	L2-1
15	4.5 to 20	0.5 to 1.5	Y	L2-1
20	6.5 to 30	1 to 2	Y	L2-2
30	8.5 to 32	1 to 2	Y	L2-2
40	9.5 to 36	1 to 2	Y	L2-2

**Symbol: A48**

Shorten the long shaft.  
• Applicable shaft type: Y

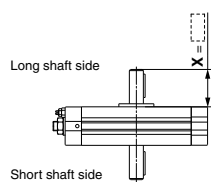

Size	X
20	17 to 30
30	18 to 32
40	18.5 to 36

## Shaft Pattern Sequencing II

-XA49 to XA57

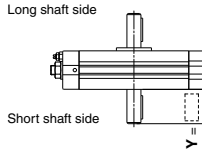
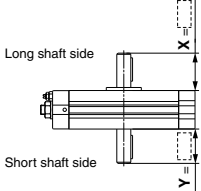
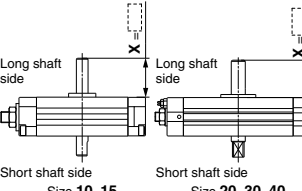
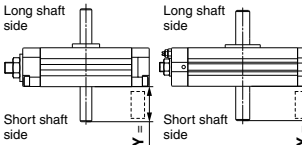
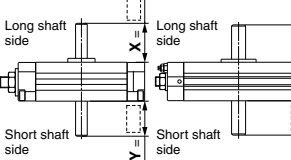
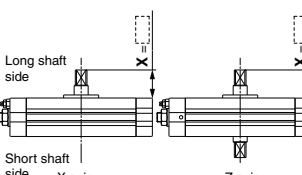
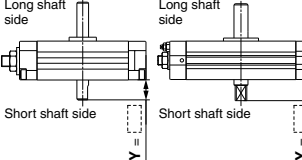
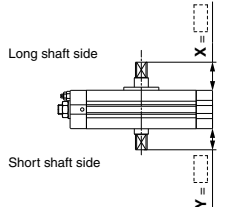
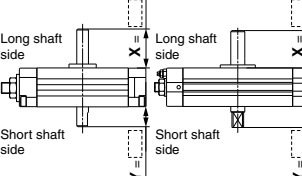
<p><b>Symbol: A49</b></p> <p>Shorten the short shaft. • Applicable shaft type: Y</p>  <p>Long shaft side Short shaft side</p> <p>Size 20, 30, 40</p> <table border="1"> <thead> <tr> <th>Size</th> <th>Y (mm)</th> </tr> </thead> <tbody> <tr> <td>20</td> <td>17 to 30</td> </tr> <tr> <td>30</td> <td>18 to 32</td> </tr> <tr> <td>40</td> <td>18.5 to 36</td> </tr> </tbody> </table>	Size	Y (mm)	20	17 to 30	30	18 to 32	40	18.5 to 36	<p><b>Symbol: A50</b></p> <p>Both the long shaft and short shaft are shortened. • Applicable shaft type: Y</p>  <p>Long shaft side Short shaft side</p> <p>Size 20, 30, 40</p> <table border="1"> <thead> <tr> <th>Size</th> <th>X (mm)</th> <th>Y (mm)</th> </tr> </thead> <tbody> <tr> <td>20</td> <td>17 to 30</td> <td>17 to 30</td> </tr> <tr> <td>30</td> <td>18 to 32</td> <td>18 to 32</td> </tr> <tr> <td>40</td> <td>18.5 to 36</td> <td>18.5 to 36</td> </tr> </tbody> </table>	Size	X (mm)	Y (mm)	20	17 to 30	17 to 30	30	18 to 32	18 to 32	40	18.5 to 36	18.5 to 36	<p><b>Symbol: A51</b></p> <p>Shorten the long shaft. • Applicable shaft types: J, K, T</p>  <p>Long shaft side Short shaft side</p> <p>Size 10, 15</p> <p>Long shaft side Short shaft side</p> <p>Size 20, 30, 40</p> <table border="1"> <thead> <tr> <th>Size</th> <th>X (mm)</th> </tr> </thead> <tbody> <tr> <td>10</td> <td>3 to 18</td> </tr> <tr> <td>15</td> <td>3 to 20</td> </tr> <tr> <td>20</td> <td>3.5 to 30</td> </tr> <tr> <td>30</td> <td>4 to 32</td> </tr> <tr> <td>40</td> <td>4 to 36</td> </tr> </tbody> </table>	Size	X (mm)	10	3 to 18	15	3 to 20	20	3.5 to 30	30	4 to 32	40	4 to 36										
Size	Y (mm)																																											
20	17 to 30																																											
30	18 to 32																																											
40	18.5 to 36																																											
Size	X (mm)	Y (mm)																																										
20	17 to 30	17 to 30																																										
30	18 to 32	18 to 32																																										
40	18.5 to 36	18.5 to 36																																										
Size	X (mm)																																											
10	3 to 18																																											
15	3 to 20																																											
20	3.5 to 30																																											
30	4 to 32																																											
40	4 to 36																																											
<p><b>Symbol: A52</b></p> <p>Shorten the short shaft. • Applicable shaft type: K</p>  <p>Long shaft side Short shaft side</p> <p>Size 10, 15</p> <p>Long shaft side Short shaft side</p> <p>Size 20, 30, 40</p> <table border="1"> <thead> <tr> <th>Size</th> <th>Y (mm)</th> </tr> </thead> <tbody> <tr> <td>10</td> <td>1 to 18</td> </tr> <tr> <td>15</td> <td>1 to 20</td> </tr> <tr> <td>20</td> <td>1 to 30</td> </tr> <tr> <td>30</td> <td>1 to 32</td> </tr> <tr> <td>40</td> <td>1 to 36</td> </tr> </tbody> </table>	Size	Y (mm)	10	1 to 18	15	1 to 20	20	1 to 30	30	1 to 32	40	1 to 36	<p><b>Symbol: A53</b></p> <p>Both the long shaft and short shaft are shortened. • Applicable shaft type: K</p>  <p>Long shaft side Short shaft side</p> <p>Size 10, 15</p> <p>Long shaft side Short shaft side</p> <p>Size 20, 30, 40</p> <table border="1"> <thead> <tr> <th>Size</th> <th>X (mm)</th> <th>Y (mm)</th> </tr> </thead> <tbody> <tr> <td>10</td> <td>3 to 18</td> <td>1 to 18</td> </tr> <tr> <td>15</td> <td>3 to 20</td> <td>1 to 20</td> </tr> <tr> <td>20</td> <td>3.5 to 30</td> <td>1 to 30</td> </tr> <tr> <td>30</td> <td>4 to 32</td> <td>1 to 32</td> </tr> <tr> <td>40</td> <td>4 to 36</td> <td>1 to 36</td> </tr> </tbody> </table>	Size	X (mm)	Y (mm)	10	3 to 18	1 to 18	15	3 to 20	1 to 20	20	3.5 to 30	1 to 30	30	4 to 32	1 to 32	40	4 to 36	1 to 36	<p><b>Symbol: A54</b></p> <p>Shorten the long shaft. • Applicable shaft types: X, Z</p>  <p>Long shaft side Short shaft side</p> <p>X axis</p> <p>Z axis</p> <table border="1"> <thead> <tr> <th>Size</th> <th>X (mm)</th> </tr> </thead> <tbody> <tr> <td>20</td> <td>3.5 to 21</td> </tr> <tr> <td>30</td> <td>4 to 24</td> </tr> <tr> <td>40</td> <td>4 to 27</td> </tr> </tbody> </table>	Size	X (mm)	20	3.5 to 21	30	4 to 24	40	4 to 27				
Size	Y (mm)																																											
10	1 to 18																																											
15	1 to 20																																											
20	1 to 30																																											
30	1 to 32																																											
40	1 to 36																																											
Size	X (mm)	Y (mm)																																										
10	3 to 18	1 to 18																																										
15	3 to 20	1 to 20																																										
20	3.5 to 30	1 to 30																																										
30	4 to 32	1 to 32																																										
40	4 to 36	1 to 36																																										
Size	X (mm)																																											
20	3.5 to 21																																											
30	4 to 24																																											
40	4 to 27																																											
<p><b>Symbol: A55</b></p> <p>Shorten the short shaft. • Applicable shaft type: J, Z</p>  <p>Long shaft side Short shaft side</p> <p>Size 10, 15</p> <p>Long shaft side Short shaft side</p> <p>Size 20, 30, 40</p> <table border="1"> <thead> <tr> <th>Size</th> <th>Y (mm)</th> </tr> </thead> <tbody> <tr> <td>10</td> <td>1 to 9</td> </tr> <tr> <td>15</td> <td>1 to 10</td> </tr> <tr> <td>20</td> <td>1 to 15</td> </tr> <tr> <td>30</td> <td>1 to 18</td> </tr> <tr> <td>40</td> <td>1 to 20</td> </tr> </tbody> </table>	Size	Y (mm)	10	1 to 9	15	1 to 10	20	1 to 15	30	1 to 18	40	1 to 20	<p><b>Symbol: A56</b></p> <p>Both the long shaft and short shaft are shortened. • Applicable shaft type: Z</p>  <p>Long shaft side Short shaft side</p> <p>Size 20, 30, 40</p> <table border="1"> <thead> <tr> <th>Size</th> <th>X (mm)</th> <th>Y (mm)</th> </tr> </thead> <tbody> <tr> <td>20</td> <td>3.5 to 21</td> <td>1 to 15</td> </tr> <tr> <td>30</td> <td>4 to 24</td> <td>1 to 18</td> </tr> <tr> <td>40</td> <td>4 to 27</td> <td>1 to 20</td> </tr> </tbody> </table>	Size	X (mm)	Y (mm)	20	3.5 to 21	1 to 15	30	4 to 24	1 to 18	40	4 to 27	1 to 20	<p><b>Symbol: A57</b></p> <p>Both the long shaft and short shaft are shortened. • Applicable shaft type: J</p>  <p>Long shaft side Short shaft side</p> <p>Size 10, 15</p> <p>Long shaft side Short shaft side</p> <p>Size 20, 30, 40</p> <table border="1"> <thead> <tr> <th>Size</th> <th>X (mm)</th> <th>Y (mm)</th> </tr> </thead> <tbody> <tr> <td>10</td> <td>3 to 18</td> <td>1 to 9</td> </tr> <tr> <td>15</td> <td>3 to 20</td> <td>1 to 10</td> </tr> <tr> <td>20</td> <td>3.5 to 30</td> <td>1 to 15</td> </tr> <tr> <td>30</td> <td>4 to 32</td> <td>1 to 18</td> </tr> <tr> <td>40</td> <td>4 to 36</td> <td>1 to 20</td> </tr> </tbody> </table>	Size	X (mm)	Y (mm)	10	3 to 18	1 to 9	15	3 to 20	1 to 10	20	3.5 to 30	1 to 15	30	4 to 32	1 to 18	40	4 to 36	1 to 20
Size	Y (mm)																																											
10	1 to 9																																											
15	1 to 10																																											
20	1 to 15																																											
30	1 to 18																																											
40	1 to 20																																											
Size	X (mm)	Y (mm)																																										
20	3.5 to 21	1 to 15																																										
30	4 to 24	1 to 18																																										
40	4 to 27	1 to 20																																										
Size	X (mm)	Y (mm)																																										
10	3 to 18	1 to 9																																										
15	3 to 20	1 to 10																																										
20	3.5 to 30	1 to 15																																										
30	4 to 32	1 to 18																																										
40	4 to 36	1 to 20																																										

Symbol

**-XA58 to XA59**

**Shaft Pattern Sequencing II**

**Symbol: A58**

The rotation axis is reversed, and then shorten the long and short shafts.

- Applicable shaft type: J, T

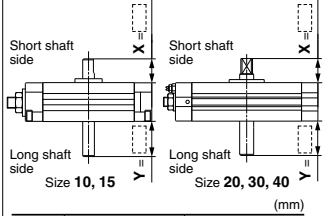

Size	X	Y
10	3 to 10	1 to 17
15	3 to 11	1 to 19
20	3.5 to 16.5	1 to 28.5
30	4 to 20	1 to 30
40	4 to 22	1 to 34

(mm)

**Symbol: A59**

The rotation axis is reversed, and then shorten the long shaft.

- Applicable shaft type: X

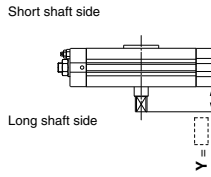

Size	Y
20	1 to 19.5
30	1 to 22
40	1 to 25

(mm)



## How to Order

**C** **D** **RQ2B** **S** **P** **20** **90** **M9BW** **X** **C7** **C12** **C30** **-X6**

### Built-in magnet

Nil	None
D	Built-in magnet

### Shaft type

Standard	Shaft type
S	Single shaft
W	Double shaft
X	Single shaft with four chamfers
Y	Double shaft key
Z	Double shaft with four chamfers
T	Single round shaft
J	Double shaft
K	Double round shaft

### Size

10
15
20
30
40

### Auto switch

Refer to page 295 for the part no. of auto switches.

### Air cushion

Size	Air cushion	
	None	Attached
10, 15	Nil	—
20, 30, 40	Nil	—

### Rotating angle

90	80° to 100°
180	170° to 190°
360	350° to 370°

### Thread type

Size	Port type	
10, 15	Nil	M5
20, 30, 40	Nil	Rc 1/8
	TF	G 1/8
	TN	NPT 1/8
	TT	NPTF 1/8

### Symbol for simple specials, Made-to-Order products

- When number of combinations is 1 or 2, refer to chart 2, 4 and 5.
- Combination of XA is possible for up to 2 types.
- Combination of -X6 (shaft, parallel key stainless spec.) is available for all the types.

### Combination 3 Types

C7	C30	C69
C12	C22	-X6

### Combination of Applicable Chart

Chart 5
Chart 5

Combination is available only when all the conditions are fulfilled among the combination chart above.

### Combination 4 Types

C7	C12	C30	-X6
----	-----	-----	-----

Chart 5
---------

Combination is available only when all the conditions are fulfilled among the combination chart above.

\* Combination of Made-to-Order is available up to 4 types.

### How to order model with auto switches

Refer to page 295 for "How to Order" products with auto switches.

## Combination Chart of Made to Order

Chart 5. Combination between -XC□ and -XC□

Symbol	Description	Applicable size	Combination			
XC7	Reversed shaft	10, 15, 20, 30, 40	●	●	●	●
XC8 to XC11	Change of rotating range					
XC12 to XC15	Change in angle adjustable range 0° to 100°					
XC16	Change in angle adjustable range 90° to 190°					
XC17	Change of rotating range					
XC18 to XC21	Change in angle adjustable range 90° to 190°	20, 30, 40	XC7 to XC17	XC18 to XC21	XC22	
XC22	Without inner rubber bumper	10, 15	●			
XC30	Fluorine grease	10, 15, 20, 30, 40	●	●	●	XC30
XC69	Fluororubber seal	10, 15, 20, 30, 40	●	●	●	●



**1 Reversed Shaft**

Symbol  
**-XC7**

CRQ2B  
CDRQ2B Refer to "How to Order" on page 295. —XC7

Reversed shaft ●

**Specifications**

Applicable size	10, 15, 20, 30, 40
Applicable shaft type	S, W, X, T, J shaft

Short shaft side

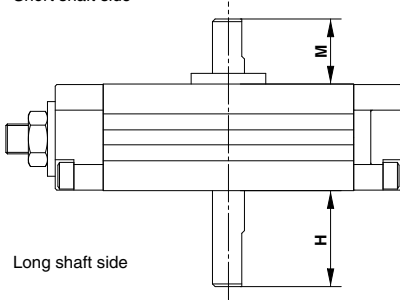

Long shaft side

**Size 10, 15**

(mm)

Size	M	H
10	10	17 (—)*
15	11	19 (—)*
20	16.5	28.5 (19.5)*
30	20	30 (22)*
40	22	34 (25)*

\* For X shaft

Short shaft side

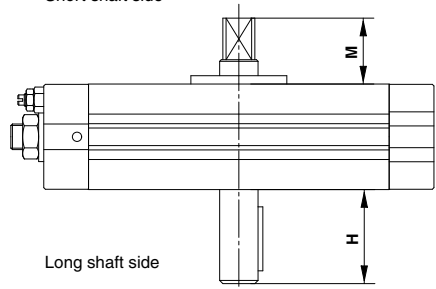

Long shaft side

**Size 20, 30, 40**

# CRQ2 Series

## Made to Order Specifications 2

Please contact SMC for detailed dimensions, specifications and lead times.



### 2 Change of Rotating Range

Symbol

-XC8 to XC11, XC18/XC19

CRQ2B  
CDRQ2B Refer to "How to Order" on page 295. —X C8

#### Specifications

Applicable shaft type S, W, Y

Symbol  
-XC8 to XC11, XC18/XC19

#### Additional Reminders

The rotation starting point shows the positions of one flat chamfering and the key groove when pressurized to the connecting port (B).

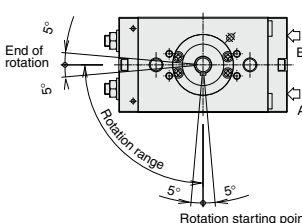
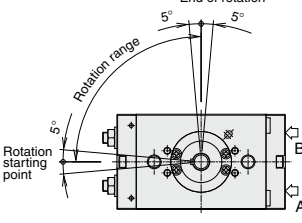
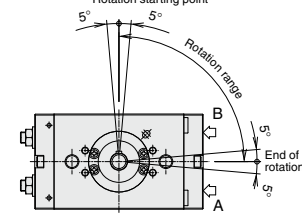
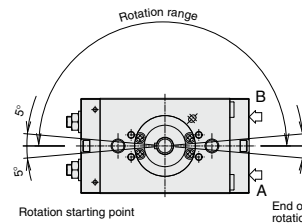
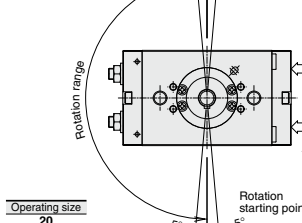
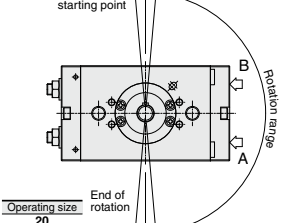
<p><b>Symbol: C8</b></p> <p>Angle adjustment at the rotation starting point and the end point are at <math>\pm 5^\circ</math>. Rotating range is changed. Rotation angle is at <math>90^\circ \pm 10^\circ</math>. The rotation starting point is on the perpendicular line (down).</p>  <p>The figure shows the view from the long shaft end.</p>	<p><b>Symbol: C9</b></p> <p>Angle adjustment at the rotation starting point and the end point are at <math>\pm 5^\circ</math>. Rotating range is changed. Rotation angle is at <math>90^\circ \pm 10^\circ</math>. The rotation starting point is on the horizontal line (left).</p>  <p>The figure shows the view from the long shaft end.</p>	<p><b>Symbol: C10</b></p> <p>Angle adjustment at the rotation starting point and the end point are at <math>\pm 5^\circ</math>. Rotating range is changed. Rotation angle is at <math>90^\circ \pm 10^\circ</math>. The rotation starting point is on the perpendicular line (up).</p>  <p>The figure shows the view from the long shaft end.</p>								
<p><b>Symbol: C11</b></p> <p>Angle adjustment at the rotation starting point and the end point are at <math>\pm 5^\circ</math>. Rotating range is changed. Rotation angle is at <math>180^\circ \pm 10^\circ</math>. The rotation starting point is on the horizontal line (left).</p>  <p>The figure shows the view from the long shaft end.</p>	<p><b>Symbol: C18</b></p> <p>Angle adjustment at the rotation starting point and the end point are at <math>\pm 5^\circ</math>. Rotating range is changed. Rotation angle is at <math>180^\circ \pm 10^\circ</math>. The rotation starting point is on the perpendicular line (down).</p>  <p>The figure shows the view from the long shaft end.</p> <table border="1" data-bbox="403 1276 492 1340"> <thead> <tr> <th>Operating size</th> </tr> </thead> <tbody> <tr> <td>20</td> </tr> <tr> <td>30</td> </tr> <tr> <td>40</td> </tr> </tbody> </table>	Operating size	20	30	40	<p><b>Symbol: C19</b></p> <p>Angle adjustment at the rotation starting point and the end point are at <math>\pm 5^\circ</math>. Rotating range is changed. Rotation angle is at <math>180^\circ \pm 10^\circ</math>. The rotation starting point is on the perpendicular line (up).</p>  <p>The figure shows the view from the long shaft end.</p> <table border="1" data-bbox="728 1276 817 1340"> <thead> <tr> <th>Operating size</th> </tr> </thead> <tbody> <tr> <td>20</td> </tr> <tr> <td>30</td> </tr> <tr> <td>40</td> </tr> </tbody> </table>	Operating size	20	30	40
Operating size										
20										
30										
40										
Operating size										
20										
30										
40										

**3 Change of Angle Adjustable Range (0° to 100°, 90° to 190°)**

Symbol  
-XC12 to XC17, XC20/XC21

CRQ2B  
CDRQ2B Refer to "How to Order" on page 295.

Symbol **C12**

-XC12 to XC17, XC20/XC21

**Specifications**

Applicable shaft type S, W, Y, X\*, Z\*, T\*, J\*, K\*

**Additional Reminders**

The rotation starting point is the position of the flat and the key groove when the actuator is pressurized through connection port B.

There are no air cushion effects in the rotating ranges of 70° or 160° shown in the diagram.

\* Only XC12 and XC16 are compatible with shaft types X, Z, T, J and K.

Symbol: **C12**

The rotation angle can be adjusted between 0° and 100°.

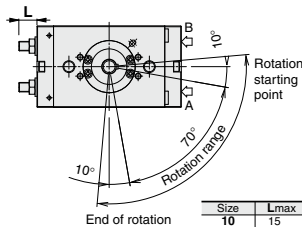

The figure shows the view from the long shaft end.

Symbol: **C13**

The rotation angle can be adjusted between 0° and 100°.

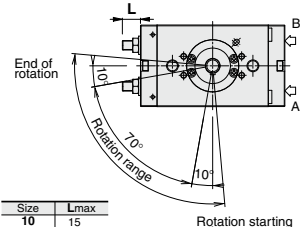

The figure shows the view from the long shaft end.

Symbol: **C14**

The rotation angle can be adjusted between 0° and 100°.

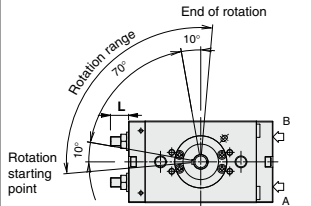

The figure shows the view from the long shaft end.

Symbol: **C15**

The rotation angle can be adjusted between 0° and 100°.

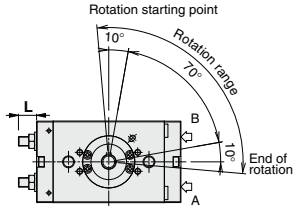

The figure shows the view from the long shaft end.

Symbol: **C16**

The rotation angle can be adjusted between 90° and 190°.

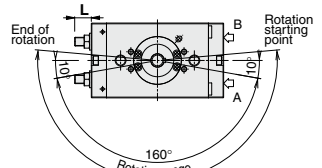

The figure shows the view from the long shaft end.

Symbol: **C17**

The rotation angle can be adjusted between 90° and 190°.

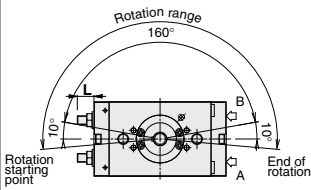

The figure shows the view from the long shaft end.

Symbol: **C20**

The rotation angle can be adjusted between 90° and 190°.

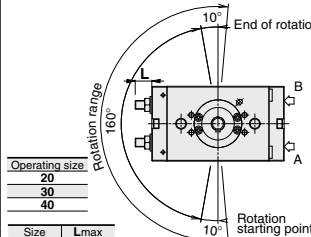

The figure shows the view from the long shaft end.

Symbol: **C21**

The rotation angle can be adjusted between 90° and 190°.

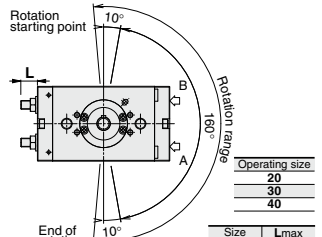

The figure shows the view from the long shaft end.

# CRQ2 Series

## Made to Order Specifications 3

Please contact SMC for detailed dimensions, specifications and lead times.



### 4 Without Inner Rubber Bumper Symbol -XC22

C RQ2B Refer to "How to Order" on page 295. — XC22  
CDRQ2B

Without inner rubber bumper

### 5 Fluorine Grease Symbol -XC30

C RQ2B Refer to "How to Order" on page 295. — XC30  
CDRQ2B

Fluorine grease

Fluorine grease is used as lubricant oil in seal part of packing and inner wall of cylinder. (Not for low-speed specification.)

#### Specifications

Fluid	Air (Non-lube)
Applicable size	10, 15
Max. operating pressure	0.7 MPa
Min. operating pressure	0.15 MPa
Port size	M5 x 0.8
Rotation	80° to 100°, 170° to 190°, 350° to 370°
Applicable shaft type	S, W, X, Y, Z, T, J, K
Auto switch	Mountable

\*Refer to page 296 for other specifications.

Refer to pages 299 and 300 for other specifications.

### 6 Fluororubber Seal Symbol -XC69

C RQ2B Refer to "How to Order" on page 295. — XC69  
CDRQ2B

Fluororubber seal

Seal material is changed to fluororubber.

### 7 Shaft, Parallel Key Made of Stainless Steel Spec. Symbol -X6

C RQ2B Shaft type Size — Rotation S-X6  
CDRQ2B

Refer to "How to Order" on page 295 for further information.

Shaft, parallel key made of stainless steel

Stainless steel is used as a substitute material for standard parts when used under conditions with a possibility of oxidation or decay.

Fluid	Air (Non-lube)
Applicable shaft type	S, W, X, Y, Z, T, J, K
Applicable size	20, 30, 40
Max. operating pressure	1.0 MPa
Min. operating pressure	0.1 MPa
Cushion	Not attached, Air cushion
Rotation range	80° to 100°, 170° to 190°, 350° to 370°
Stainless steel part	Shaft, Parallel key
Port size	Rc 1/8, G 1/8, NPT 1/8, NPTF 1/8
Auto switch	Mountable