

High Precision Filter for Liquids

FGH Series

Filtration efficiency: 99% or more

HEPO II element

Filtration accuracy: 2, 4, 6 or 13 μm (Filtration efficiency 99%)

Membrane element

Filtration accuracy: 0.2 or 0.4 μm (Filtration efficiency 99.9%)



FGD

FGE

FGG

FGA

FGC

FGF

FGH

FQ1

FN

EB

ES

High Precision Filter for Liquids FGH Series

Filtration efficiency: 99% or more



Prevents particle generation in the housing

Internal particle generation is eliminated by using stainless steel 316 and PTFE for the wetted material and adopting a clamp ring system.

Integrity inspection conducted.

100%-integrity inspection is conducted.

Prevents residual liquid accumulation in the case

A simple structure prevents the residual liquid from accumulating in the case.

Application examples

Ultrasonic cleaning machine

- Manufacture of electric and electronic industrial components
- Manufacture of semiconductor-related components

Dual chamber ultrasonic cleaning machine

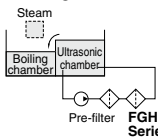

Triple chamber ultrasonic cleaning machine

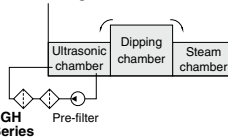

Jet cleaning machine

- Camera, lens and bearing for manufacture of high-precision processing components
- Nozzle for manufacture of automobile components

FGH Series

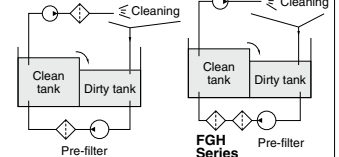

HEPO II Element

Filtration accuracy: 2, 4, 6 or 13 μm (Filtration efficiency 99%)

High precision filtration: 99% or more

High accuracy filtration is achieved by using a HEPO II element with filtration accuracy of 2, 4, 6 or 13 μm (Filtration efficiency 99%).

[Test conditions]

Fluid: water / Test dust: ACFTD / Flow rate: 35 L/min

Dust concentration: 10 mg/L / Temperature: 20°C

Element: EJ801S

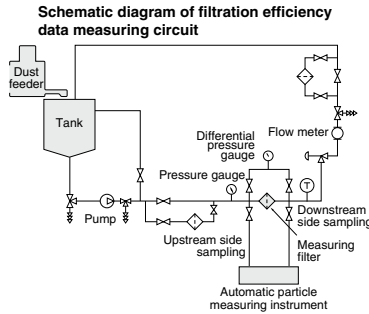
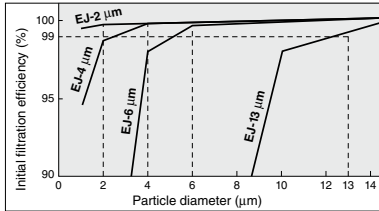

No outflow of fibers or elution of components from the filter media

There is almost no outflow of fibers or elution of components from the filter media because it uses ultrafine and long polyester fiber nonwoven fabric with no binder.

Applicable for a wide range of liquids

The element is applicable for a wide range of liquids because it adopts PTFE seals.

Applicable fluids

Classification	Description
Water	Industrial water, distilled water, ion-exchange water, DI water (Deionized water), ultrapure water
Alcohol	Isopropyl alcohol (IPA, propanol) Ethyl alcohol (ethanol) Methyl alcohol (methanol) Butyl alcohol (butanol) Ethylene glycol
Hydrocarbon	Petroleum ether, petroleum benzene
Ester	Methyl acetate, ethyl acetate, methyl acrylate
Oil/fuel oil	Hydraulic fluid, lubricating oil, light oil, kerosene, cutting oil, grinding oil
Others	Ammonia (10% solvent), ethyl ether, isopropyl ether

FGD

FGE

FGG

FGA

FGC

FGF

FGH

FQ1

FN

EB

ES

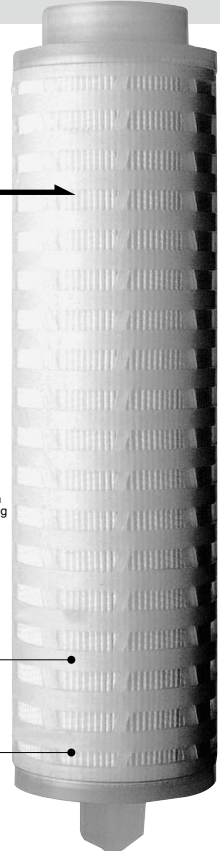

Membrane Element

Filtration accuracy: 0.2 or 0.4 μm (Filtration efficiency 99.9%)

High precision filtration: 99.9% or more

High accuracy filtration is achieved by using a membrane element with filtration accuracy of 0.2 or 0.4 μm (Filtration efficiency 99.9%)

Test conditions

Fluid: DI water (Deionized water)				
Contaminant: polystyrene latex particles				
Particle measuring method: 0.2 μm automatic particle measuring instrument				
Filtration rating (μm)	Particle diameter (μm)	Number of particles (/10 mL)		Filtration efficiency (%)
		Upstream side	Downstream side	
0.2	0.208	146380	1	99.999
	0.309	103957	2727	97.4
0.4	0.41	95019	29.9	99.97

Schematic diagram of filtration efficiency data measuring circuit

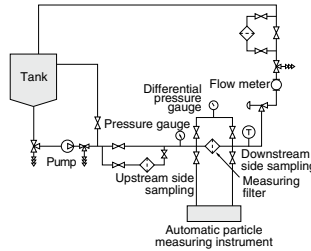

Easy to handle

There is no need of hydrophilic treatment using IPA and the like, because the element uses a hydrophilic filter media.

Long filtration life

The element has a long filtration life because of the high porosity and low pressure drop of the filter media.
The dust retention amount of the 0.2 μm version is 90 g.

Pre-rinsed with ultrapure water

(0.2 μm version only)

Applicable fluids

Classification	0.2 μm	0.4 μm
Water	DI water (Deionized water), ultrapure water, ion-exchange water, distilled water	
Alkalis	Sodium hydroxide (10%) Potassium hydroxide (10%) Ammonia water (28%)*	Ammonia water (28%)*
Aldehyde	Formaldehyde (35%)*	Formaldehyde (35%)*
Alcohol	Methyl alcohol, butyl alcohol, ethyl alcohol, propyl alcohol	
Ether	Dioxane* Ethyl ether*	Ethyl ether*
Hydrocarbon	Benzene* Hexane*	Benzene*, toluene*, hexane*, xylene*

* Can be used depending on temperature conditions (please consult with SMC).

Resistivity recovery characteristics

(Measuring conditions)
Element used: ED801S-X20
Element size: $\phi 70 \times L247$
Filtration area: 4000 cm^2
Fluid: Ultrapure water
(resistivity value 17.9 $\text{M}\Omega\text{-cm}$)
Flow rate: 10 L/min

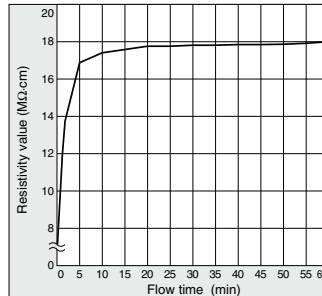

* Per JISK3834



High Precision Filter for Liquids

FGH Series



How to Order

FGH 100 - 03 - J 002 T

High precision filter for liquids

Body size

Symbol	Element length	Applicable element
100	L117	EJ701S
200	L246	EJ801S, ED801S
300	L496	EJ901S, ED901S

* The membrane element cannot be selected for FGH100.

Port size

03	Rc3/8
04	Rc1/2
06	Rc3/4
10	Rc1

Element seal

Symbol	Material
T	PTFE

Filtration accuracy

Symbol	Filtration accuracy	Applicable for	Applicable body
002	2 μm	HEPO II	FGH100 to 300
004	4 μm		
006	6 μm		
013	13 μm		
X20	0.2 μm	Membrane	FGH200 to 300
X40	0.4 μm		

Element classification Note)

Symbol	Element
J	HEPO II
D	Membrane

Note) Refer to pages 70 to 73 for details about specifications, models, dimensions, etc. regarding the elements.



Specifications

Model	FGH100	FGH200	FGH300
Number of built-in elements (element length) (mm)	1(125)	1(250)	1(500)
Operating pressure	MAX. 1 MPa		
Operating temperature	MAX. 80°C (Not above the boiling point)		
Applicable fluid	Each kind of fluid (See the table of applicable fluids on pages 63 and 64)		
Port size (Rc)	3/8, 1/2, 3/4, 1		
Material	Housing	Stainless steel 316 (Electrolytic polishing)	
	Seals	PTFE	
Weight (kg)	2.6	3.2	4.3
Internal capacity (L)	1.0	1.8	3.3

FGD

FGE

FGG

FGA

FGC

FGF

FGH

FQ1

FN

EB

ES

FGH Series

Flow Rate Characteristics of Built-in HEPO II Elements (Fluid: water, temperature: 20°C) —002 (2 μm)—004 (4 μm)—006 (6 μm)—013 (13 μm)

FGH100 Series

FGH100-03 {Rc3/8}

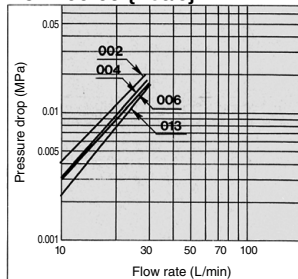

FGH200 Series

FGH200-03 {Rc3/8}

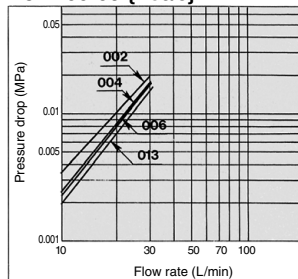

FGH300 Series

FGH300-03 {Rc3/8}

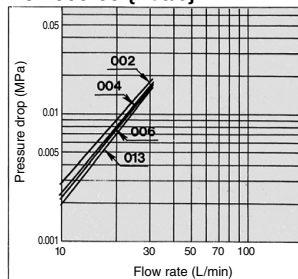

FGH100-04 {Rc1/2}

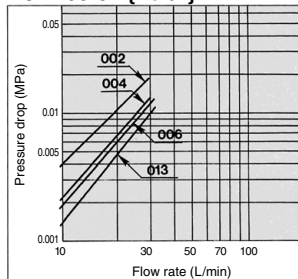

FGH200-04 {Rc1/2}

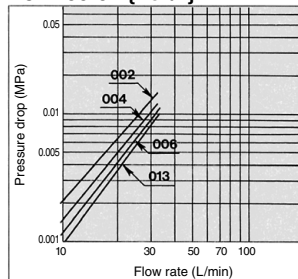

FGH300-04 {Rc1/2}

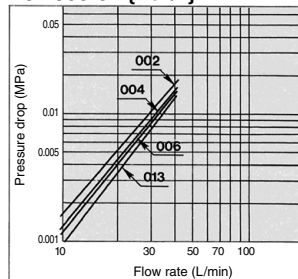

FGH100-06 {Rc3/4}

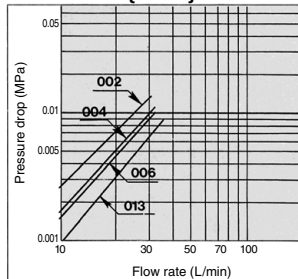

FGH200-06 {Rc3/4}

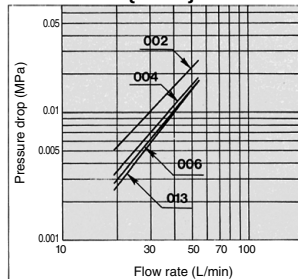

FGH300-06 {Rc3/4}

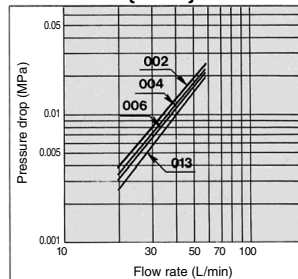

FGH100-10 {Rc1}

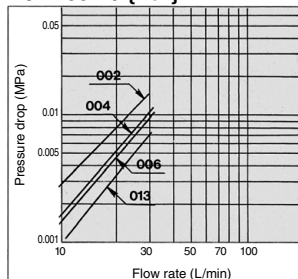

FGH200-10 {Rc1}

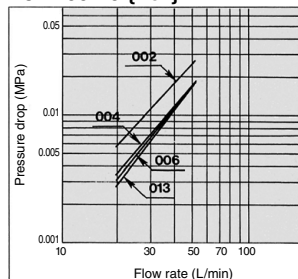

FGH300-10 {Rc1}

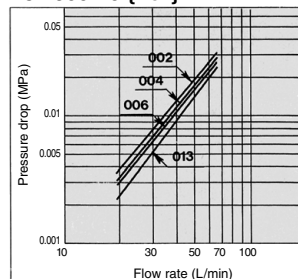

Flow Rate Characteristics of Built-in Membrane Elements (Fluid: water, temperature: 20°C)

FGH200 Series

— X20 (0.2 μm)
 - - - X40 (0.4 μm)

FGH200-03 {Rc3/8}

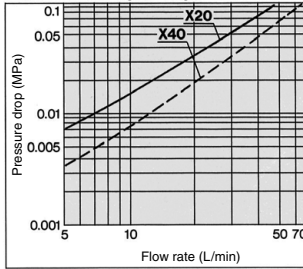

FGH200-04 {Rc1/2}

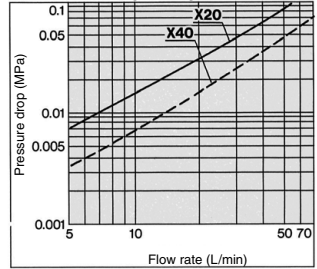

FGH200-06 {Rc3/4}

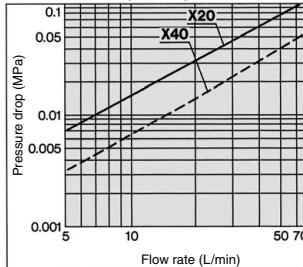

FGH200-10 {Rc1}

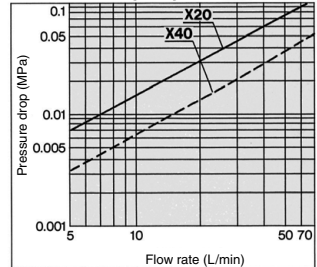

- FGD
- FGE
- FGG
- FGA
- FGC
- FGF
- FGH**
- FQ1
- FN
- EB
- ES

FGH300 Series

— X20 (0.2 μm)
 - - - X40 (0.4 μm)

FGH300-03 {Rc3/8}

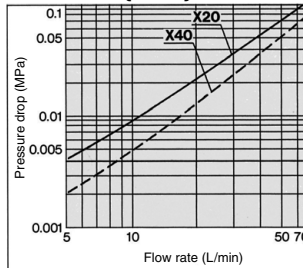

FGH300-04 {Rc1/2}

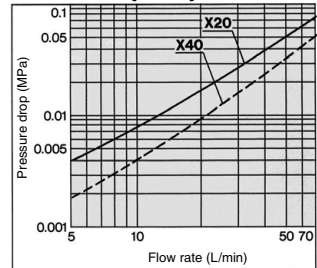

FGH300-06 {Rc3/4}

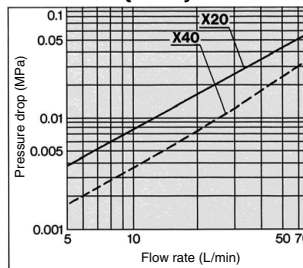

FGH300-10 {Rc1}

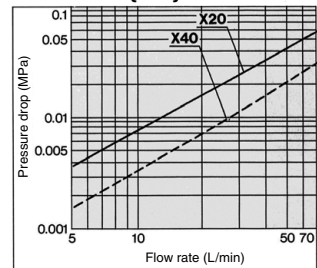

Construction/Spare Parts and Seal List

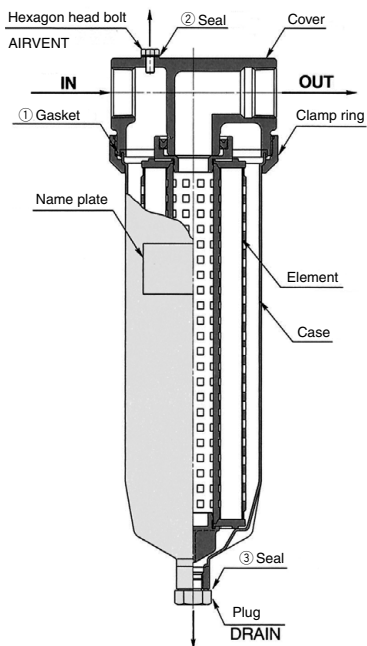

Spare Parts and Seal List

No.	Description	Part number		
		FGH100	FGH200	FGH300
1	Gasket	AL-58S#1		
2	Seal	AL-43S		
3	Seal	AL-53S		

* Use each one of the above parts for each filter unit.

* Use a commercially available belt wrench etc. for mounting and removing clamp rings.

Dimensions

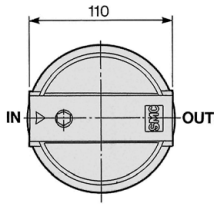

FGH100/200

FGH300

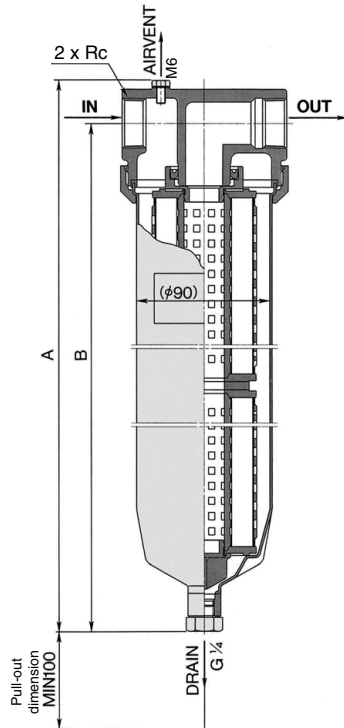
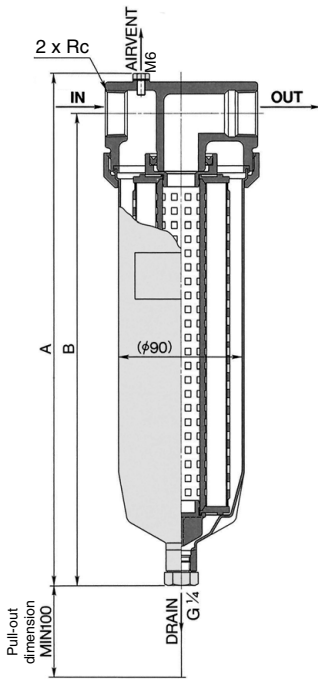

FGD

FGE

FGG

FGA

FGC

FGF

FGH

FQ1

FN

EB

ES

Dimensions

Model	Element length	Port size (Rc)	A	B
FGH100	$\phi 70 \times L117$	3/8, 1/2	235	211
		3/4, 1	240	
FGH200	$\phi 70 \times L246$	3/8, 1/2	364	340
		3/4, 1	369	
FGH300	$\phi 70 \times L496$	3/8, 1/2	615	591
		3/4, 1	620	

HEPO II Element for FGH Series

EJ Series

RoHS



Specifications

Model		EJ□S-002	EJ□S-004	EJ□S-006	EJ□S-013	
Filtration accuracy (Filtration efficiency 99%)		2	4	6	13	
Filtration area (cm ²)	Length	117 mm	1890	2310	2090	2490
		246 mm	4250	5200	4700	5600
		496 mm	8500	10400	9400	11200
Heat resistant temperature (°C)		80				
Material	Filter media	Polyester				
	Reinforcement material	Polypropylene				
	Others	Polypropylene				
Element replacement differential pressure		0.1 MPa				
Differential pressure resistance		0.5 MPa at 20°C, 0.125 MPa at 80°C				

Note) See "How to Order" below for items represented by □.

How to Order Elements

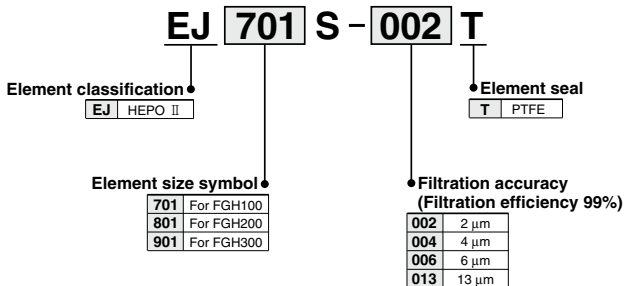

Construction

EJ701S, 801S, 901S

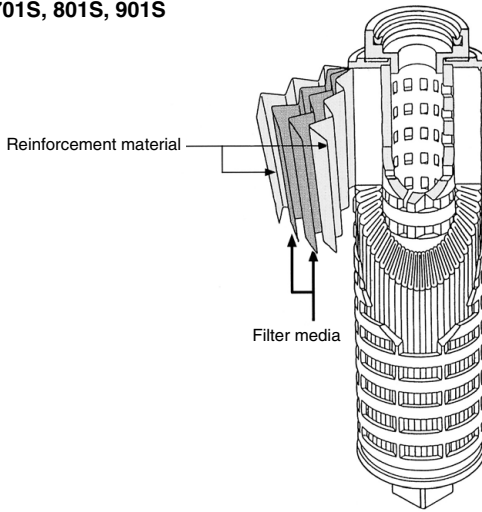

- FGD
- FGE
- FGG
- FGA
- FGC
- FGF
- FGH**
- FQ1
- FN
- EB
- ES

Dimensions

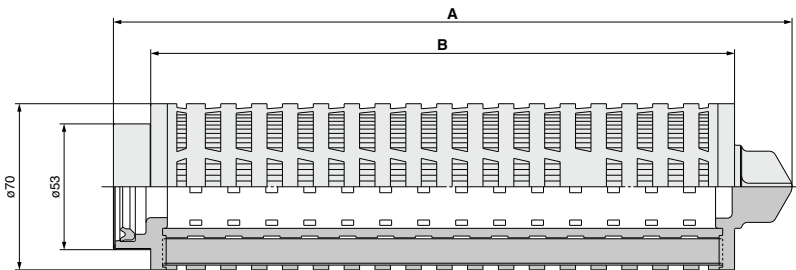

Element Dimensions

Model	A	B	Applicable container
EJ701S-□T	157	117	FGH100
EJ801S-□T	286	246	FGH200
EJ901S-□T	538	498	FGH300

Membrane Element for FGH Series

ED Series



Specifications

Model		ED□S-X20	ED□S-X40
Filtration accuracy (Filtration efficiency 99.9%) <small>Note 1)</small>		0.2	0.4
Filtration area (cm ²)	Length		
	247 mm	4,000	6,200
	495 mm	8,000	12,400
Heat resistant temperature (°C)		80	
Material	Filter media	Polyether sulfone	Cellulose acetate & polyester
	Reinforcement material	Polypropylene	
	Others	Polypropylene	
Element relacement differential pressure		0.1 MPa	
Differential pressure resistance		0.5 MPa at 20°C, 0.125 MPa at 80°C	
Resistivity recovery <small>Note 2)</small>		60 min at 10 L/min	—
Others		100 L/4000 cm ² Pure water cleaning	—

Note 1) Filtration accuracy: tested with ultrapure water, flow rate at ΔP = 0.01 MPa.

Note 2) Resistivity recovery: time taken to recover to 18 MΩ·cm with ultrapure water.

Note 3) See "How to Order" below for items represented by □.

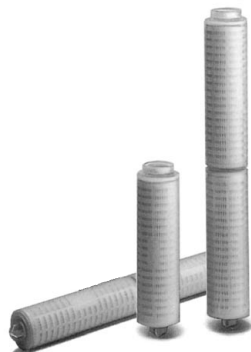

How to Order Elements

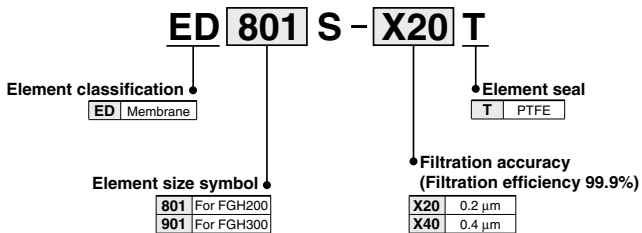

* Cannot be used for FGH100.

Construction

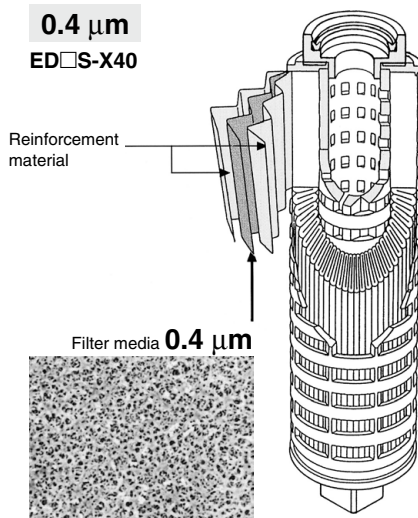
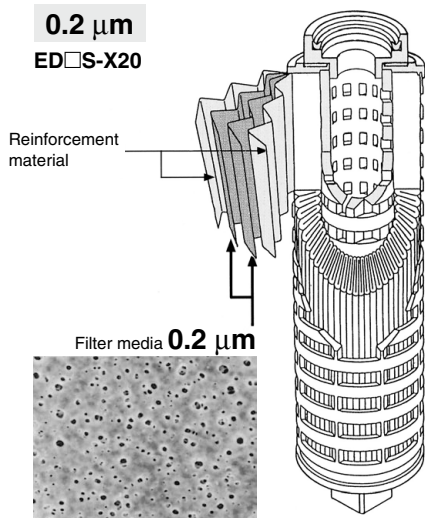

FGD
FGE
FGG
FGA
FGC
FGF
FGH
FQ1
FN
EB <input type="checkbox"/>
ES <input type="checkbox"/>

Dimensions

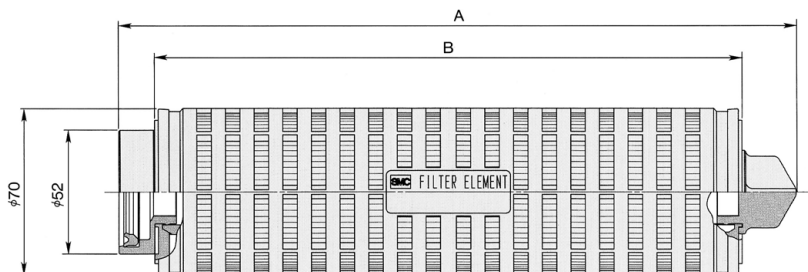

Element Dimensions

Model	A	B	Applicable container
ED801S-X□T	285	247	FGH200
ED901S-X□T	533	495	FGH300