

3 Port Solenoid Valve

Direct Operated Poppet Type

VK300 Series

Rubber Seal



Universal porting

Available for N.C. valve, N.O. valve, divider valve, selector valve, etc.

C: 0.80 dm³/(s·bar)

(Passage 2 → 3)

Compact: Width 18 x Length 63 (mm)

Low power consumption

4 W DC (Standard type)

2 W DC (Low wattage type)

Suitable for use in vacuum applications –101.2 kPa

Suitable for use in copper-free applications

The portions that come in contact with fluids do not contain copper, thus enabling the standard product to be used as is.



Base mounted

Symbol

Body ported

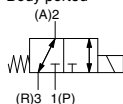

Base mounted

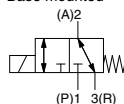

Specifications

Type of actuation	Direct operated type 2 position single solenoid
Fluid	Air
Ambient and fluid temperature	-5 to 50°C (No freezing)
Response time (at 0.5 MPa) ⁽¹⁾	10 ms or less (Standard), 15 ms or less (Low power consumption type)
Manual override	Non-locking push type
Lubrication	Not required (Use turbine oil Class 1 ISO VG32, if lubricated.)
Mounting orientation	Unrestricted
Impact/Vibration resistance ⁽²⁾	300/50 m/s ²
Enclosure	Dustproof

Note1) Based on dynamic performance test, JIS B 8419: 2010. (Coil temperature: 20°C, at rated voltage, without surge suppressor)

Note2) Impact resistance: No malfunction occurred when it is tested with a drop tester in the axial direction and at the right angles to the main valve and armature in both energized and de-energized states every once for each condition. (Values at the initial period)

Vibration resistance: No malfunction occurred in a one-sweep test between 45 and 2000 Hz. Test was performed at both energized and de-energized states in the axial direction and at the right angles to the main valve and armature. (Values at the initial period)

Solenoid Specifications

Electrical entry	Grommet (G), DIN terminal (D)		
Rated voltage (V)	AC	100, 110, 200, 220, 240	
	DC	12, 24	
Allowable voltage fluctuation	±10% of rated voltage		
Apparent power (AC) *	Standard type	Inrush	9.5 VA/50 Hz, 8 VA/60 Hz
		Holding	7 VA/50 Hz, 5 VA/60 Hz
	Continuous duty type	Inrush	3.5 VA/50 Hz, 3.3 VA/60 Hz
		Holding	3 VA/50 Hz, 2.8 VA/60 Hz
Power consumption (DC) *	Wo indicator light	4 W (Standard), 2 W (Low power consumption type)	
	W indicator light	4.3 W (Standard), 2.3 W (Low power consumption type)	
Surge voltage suppressor	AC	Varistor	
	DC	Diode (Varistor for 12 VDC or less)	
	Indicator light	Neon bulb	
	DC	LED	

* At the rated voltage

Flow Rate Characteristics/Weight

Valve model	Operating pressure range (MPa)	Port size	Flow rate characteristics												Weight (g)	
			1 → 2 (P → A)			2 → 3 (A → R)			3 → 2 (R → A)			2 → 1 (A → P)				
			C [dm ³ /(s·bar)]	b	Cv	C [dm ³ /(s·bar)]	b	Cv	C [dm ³ /(s·bar)]	b	Cv	C [dm ³ /(s·bar)]	b	Cv		
Body ported	0 to 0.7	M5 x 0.8	VK332	0.47	0.44	0.13	0.47	0.40	0.13	0.48	0.47	0.14	0.47	0.44	0.13	80
			VK332Y (For low wattage, 2 W DC)	0.41	0.27	0.10	0.39	0.35	0.10	0.41	0.38	0.11	0.38	0.40	0.10	
			VK332E (Continuous duty type)	0.41	0.27	0.10	0.39	0.35	0.10	0.41	0.38	0.11	0.38	0.40	0.10	
			VK332V (For vacuum)	0.47	0.44	0.13	0.47	0.40	0.13	0.48	0.47	0.14	0.47	0.44	0.13	
			VK332W (Low wattage, vacuum)	0.41	0.27	0.10	0.39	0.35	0.10	0.41	0.38	0.11	0.38	0.40	0.10	
Base mounted (With sub-plate)	0 to 0.7	1/8	VK334	0.85	0.26	0.19	0.80	0.27	0.19	0.83	0.26	0.20	0.76	0.41	0.20	120
			VK334Y (For low wattage, 2 W DC)	0.65	0.24	0.15	0.55	0.32	0.14	0.65	0.15	0.14	0.41	0.63	0.14	
			VK334E (Continuous duty type)	0.65	0.24	0.15	0.55	0.32	0.14	0.65	0.15	0.14	0.41	0.63	0.14	
			VK334V (For vacuum)	0.85	0.26	0.19	0.80	0.27	0.19	0.83	0.26	0.20	0.76	0.41	0.20	
			VK334W (Low wattage, vacuum)	0.65	0.24	0.15	0.55	0.32	0.14	0.65	0.15	0.14	0.41	0.63	0.14	

Mounting with VK300

The VK300 series can be mounted on the manifold base VV5K3 of VK 3000 series. Refer to page 1232 for details.

VK300 Series



How to Order

Note) AC-type models that are CE/UKCA-compliant have DIN terminals only.

Rated voltage	Valve option				
	Nil	V	Y	W	E
1 100 VAC, 50/60 Hz	●	●	—	—	●
2 200 VAC, 50/60 Hz	●	●	—	—	●
3 110 VAC, 50/60 Hz	●	●	—	—	●
4 220 VAC, 50/60 Hz	●	●	—	—	●
5 24 VDC	●	●	●	●	●
6 12 VDC	●	●	●	●	●
7 240 VAC, 50/60 Hz	●	●	—	—	●

Note1) AC-type models that are CE/UKCA-compliant have DIN terminals only.
 Note2) For other rated voltages, please consult with SMC.



Body ported VK332 [] - 1 G [] - M5 [] - [] - []

Base mounted VK334 [] - 1 G [] - 01 [] - [] - []



Valve option

Nil	Standard type
V	For vacuum
Y	For low wattage
W	For vacuum/low wattage
E	Continuous duty type

CE/UKCA compliant	Electrical entry			
	G: Grommet (Lead wire length: 300 mm)	H: Grommet (Lead wire length: 600 mm)	D: DIN terminal	DO*: DIN terminal (Without connector)
DC	●	●	●	●
AC	—	—	●	●

* For the connector part number, refer to page 1228.

Port size (A port)

M5	M5 x 0.8
01	1/8

* P, R port: M5

Option

Nil	None
F	With bracket (Not assembled)

Option Part No.

Description	Part no.	Note
Bracket	VK300-43-2A	With screw

Thread type

Nil	Rc
F	G
N	NPT
T	NPTF

Port size

Nil*	Without sub-plate
01	1/8 (With sub-plate)

CE/UKCA-compliant

Nil	—
Q	CE/UKCA-compliant*

Note) AC-type models that are CE/UKCA-compliant have DIN terminals only.

Light/Surge voltage suppressor

	CE/UKCA-compliant
Nil*	None
S	With surge voltage suppressor
Z	With light/surge voltage suppressor (Type D only)

Note) Since the indicator light is built in connector, thus, "DOZ" is not available.

* The continuous duty AC type is equipped with a rectifier, so a diode will be provided.

Construction

Symbol

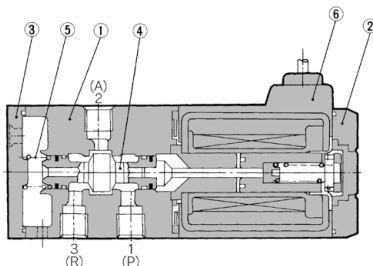
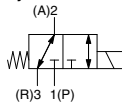

Component Parts

No.	Description	Material	Note
1	Body	Aluminum die-casted	Platinum silver
2	Cover	Resin	Black
3	End cover	Resin	Black
4	Spool valve assembly	Aluminum, NBR	
5	Return spring	Stainless steel	
6	Molded coil	Resin	Black

VK300 Series

Manifold Specifications

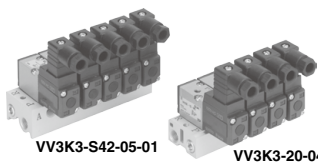

Specifications

Valve stations		1 to 20
Piping method	Common SUP, Common EXH	Body ported, Base mounted
	Common SUP, Individual EXH	Body ported

Note) For 9 stations or more, supply air both sides of P port.

The common exhaust type should exhaust from both of the R port.

Note) CE/UKCA-compliant:
For DIN terminal only



Common SUP/Common EXH

Type 20: Body ported (A port top ported)

A port: Rc 1/8, M5 x 0.8

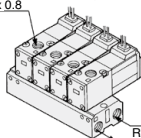

P port: Rc 1/8
R port: Rc 1/8

How to Order

VV3K3 - 20 - 05 - [] - [] - []

Valve stations

01	1 station
:	:
20	20 stations

Option

Nil	None
F	With bracket (Not mounted)

P, R port thread type

Nil	Rc
00F	G
00N	NPT
00T	NPTF

Applicable solenoid valve
VK332□-□□□□-M5(-Q)
VK332□-□□□□-01(-Q)

Applicable blanking plate assembly
VK300-42-1A

Bracket
VK300-43-1A

CE/UKCA-compliant

Nil	—
Q	CE/UKCA-compliant

Note) Applicable only for
DIN terminal type

Type 40: Base mounted (A port bottom ported)

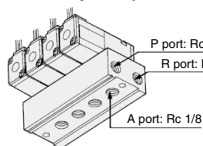

P port: Rc 1/8
R port: Rc 1/8

A port: Rc 1/8

How to Order

VV3K3 - 40 - 05 - 01 - [] - [] - []

Valve stations

01	1 station
:	:
20	20 stations

Port size

01	Rc 1/8
----	--------

Thread type

Nil	Rc
F	G
N	NPT
T	NPTF

Option

Nil	None
F	With bracket (Not mounted)

Applicable solenoid valve
VK334□-□□□□(-Q)

Applicable blanking plate assembly
VK300-42-1A

Bracket
VK300-43-1A

CE/UKCA-compliant

Nil	—
Q	CE/UKCA-compliant

Note) Applicable only for
DIN terminal type

Type 42: Base mounted (A port side ported)

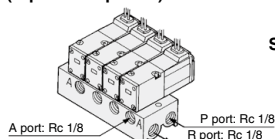

A port: Rc 1/8

P port: Rc 1/8
R port: Rc 1/8

How to Order

VV3K3 - [] - 42 - 05 - 01 - [] - [] - []

Solenoid direction

Nil	Opposite side of A port
S	Same side of A port

Port size

01	Rc 1/8
C4	ø4 cassette
C6	ø6 cassette

Thread type

Nil	Rc
F	G
N	NPT
T	NPTF

Applicable solenoid valve
VK334□-□□□□(-Q)

Applicable blanking plate assembly
VK300-42-1A

CE/UKCA-compliant

Nil	—
Q	CE/UKCA-compliant

Note) Applicable only for
DIN terminal type

Type S42

(Solenoids on the same side of A port)

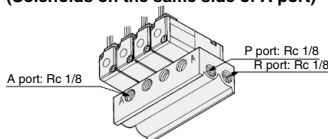

A port: Rc 1/8

P port: Rc 1/8
R port: Rc 1/8

Common SUP/Individual EXH

Type 21: Body ported (A port top ported)

A port: Rc 1/8, M5 x 0.8

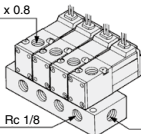

R port: Rc 1/8

P port: Rc 1/8

How to Order

VV3K3 - 21 - 05 - [] - [] - []

Valve stations

01	1 station
:	:
20	20 stations

P, R port thread type

Nil	Rc
00F	G
00N	NPT
00T	NPTF

Applicable solenoid valve
VK332□-□□□□-M5(-Q)
VK332□-□□□□-01(-Q)

Applicable blanking plate assembly
VK300-42-1A

CE/UKCA-compliant

Nil	—
Q	CE/UKCA-compliant

Note) Applicable only for
DIN terminal type

VK300 Series

Combinations of Solenoid Valve, Manifold Gasket and Manifold Base

3 port body ported: VK332

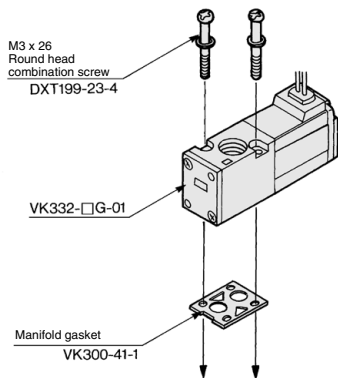

3 port base mounted: VK334

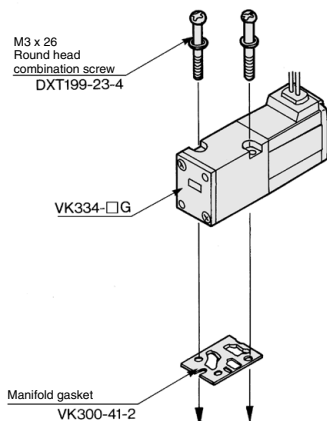

Applicable base

VV3K3-20 (-Q)
21 (-Q) } Manifold base
VV5K3-20 (-Q)
21 (-Q)

Applicable base

VK300-45-1 Sub-plate
VV3K3-40 (-Q)
(S) 42 (-Q) } Manifold base
VV5K3-40 (-Q)
(S) 41 (-Q)
(S) 42 (-Q)

	Body ported	Base mounted
Manifold gasket and screw assembly	VK300-41-1A	VK300-41-2A

Note 1) Mounting direction is fixed, do not mount on opposite side.

Note 2) The VK300 series can be mounted on the manifold base VV5K3 of VK 3000 series. Refer to page 1232 for details.

Caution
Mounting Screw
Tightening Torques
M3: 0.6 N-m

Combinations of Blanking Plate Assembly and Manifold Base

Blanking plate assembly: VK300-42-1A

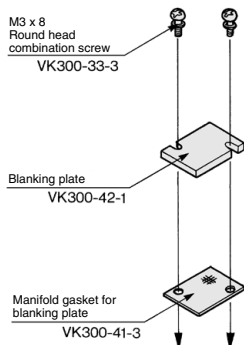

Applicable base: In common for all types of VV3K3 models

Caution
Mounting Screw
Tightening Torques
M3: 0.6 N-m

3 Port Solenoid Valve Direct Operated Poppet Type **VK300 Series**

Dimensions: Body Ported

Grommet: VK332-□G-M⁵₀₁

DIN terminal: VK332-□D-M⁵₀₁

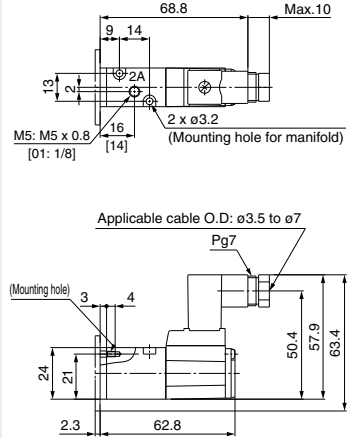
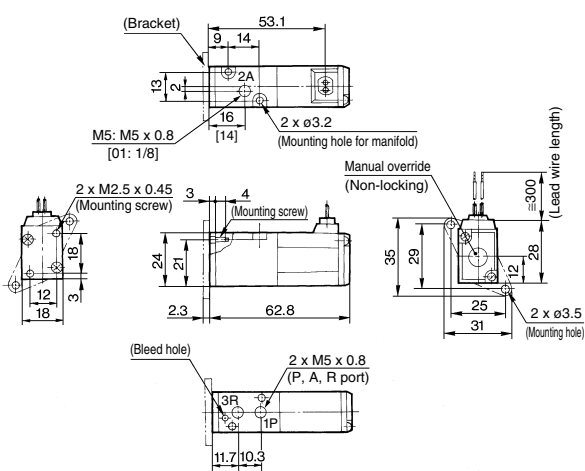

Refer to grommet type for other dimensions.
[]: For port size 01

Dimensions: Base Mounted

Grommet: VK334-□G-01

DIN terminal: VK334-□D-01

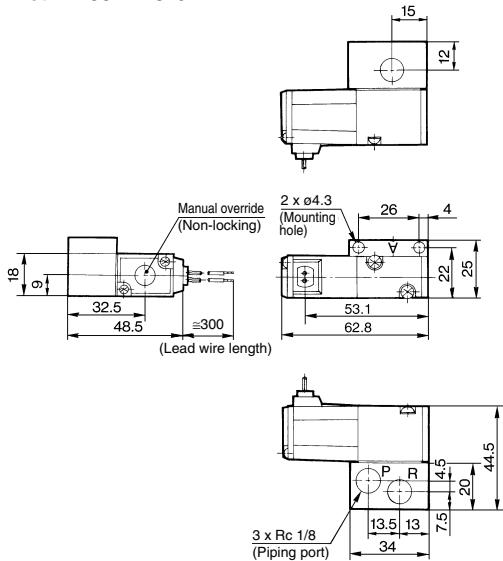

Applicable cable O.D.: $\phi 3.5$ to $\phi 7$

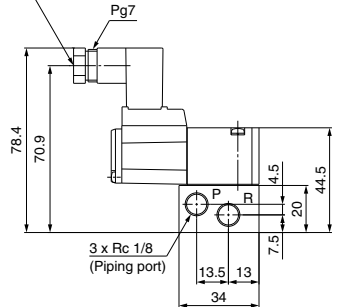

Refer to grommet type for other dimensions.

VK300 Series

Type 20 Manifold/Body Ported (Top ported)

VV3K3-20- Stations

n1 = Number of VK300

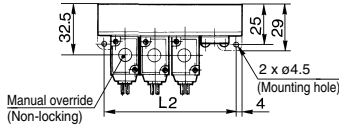

Grommet: G

DIN terminal: D

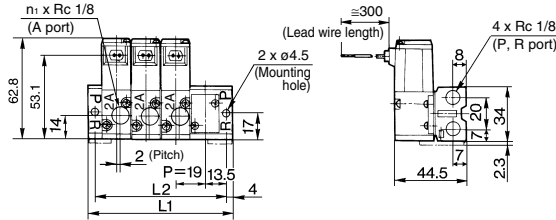

(Station 1) (Station n)

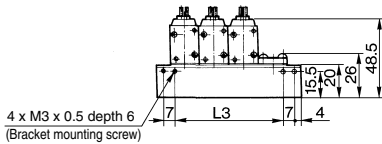

L Dimension

n: Stations

L \ n	1	2	3	4	5	6	7	8	9	10	11	12	13	14	15	16	17	18	19	20
L1	35	54	73	92	111	130	149	168	187	206	225	244	263	282	301	320	339	358	377	396
L2	27	46	65	84	103	122	141	160	179	198	217	236	255	274	293	312	331	350	369	388
L3	13	32	51	70	89	108	127	146	165	184	203	222	241	260	279	298	317	336	355	374

Type 21 Manifold/Body Ported (Top ported)

VV3K3-21- Stations

n1 = Number of VK300

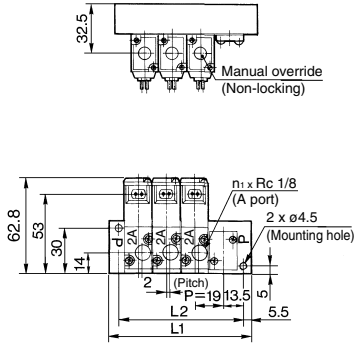

(Station 1) (Station n)

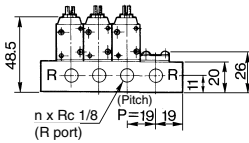

Grommet: G

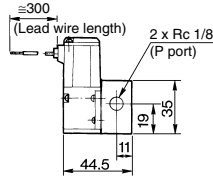

DIN terminal: D

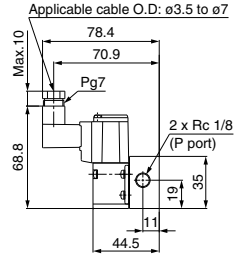

L Dimension

n: Stations

n	1	2	3	4	5	6	7	8	9	10	11	12	13	14	15	16	17	18	19	20
L1	38	57	76	95	114	133	152	171	190	209	228	247	266	285	304	323	342	361	380	399
L2	27	46	65	84	103	122	141	160	179	198	217	236	255	274	293	312	331	350	369	388

VK300 Series

Type 40 Manifold/Base Mounted (Bottom ported)

VV3K3-40- Stations -01

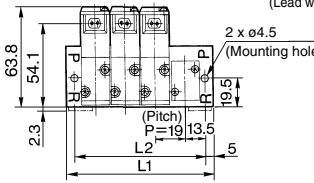
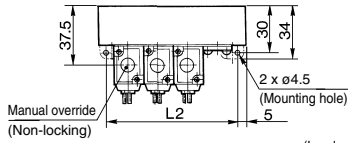

(Station 1) (Station n)

Grommet: G

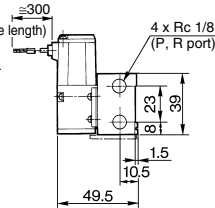

DIN terminal: D

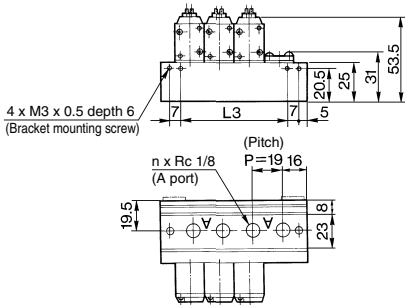
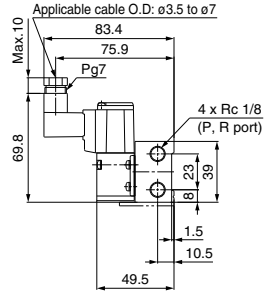

L Dimension

n: Stations

L	n	1	2	3	4	5	6	7	8	9	10	11	12	13	14	15	16	17	18	19	20
L ₁		37	56	75	94	113	132	151	170	189	208	227	246	265	284	303	322	341	360	379	398
L ₂		27	46	65	84	103	122	141	160	179	198	217	236	255	274	293	312	331	350	369	388
L ₃		13	32	51	70	89	108	127	146	165	184	203	222	241	260	279	298	317	336	355	374

Type 42 Manifold/Base Mounted (Side ported)

VV3K3-42-Stations-01

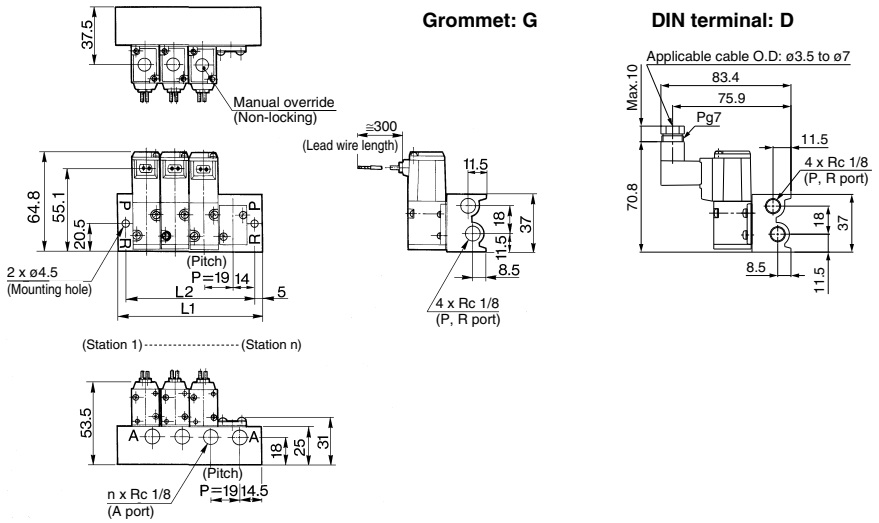

Built-in One-touch fitting: VV3K3-42-Stations-C4, C6

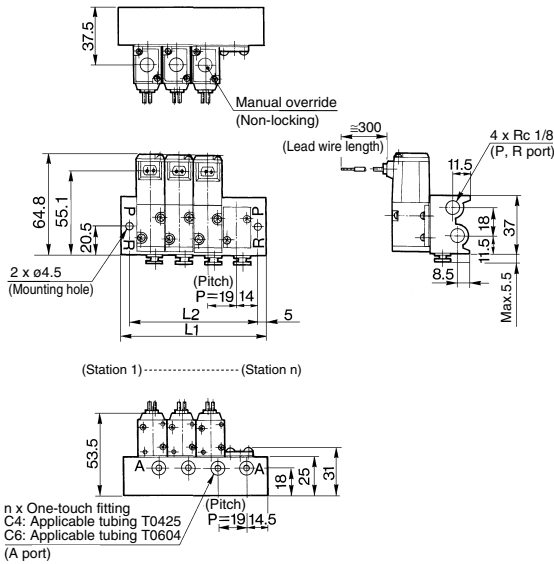

Solenoid at A port side: VV3K3-S42-Stations-□

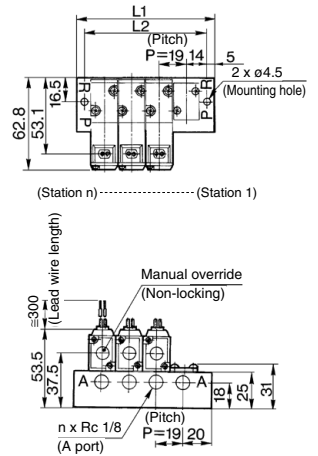

Refer to the above drawing for DIN terminal dimensions.

Refer to the above drawing for other dimensions.

L \ n	1	2	3	4	5	6	7	8	9	10	11	12	13	14	15	16	17	18	19	20
L1	38	57	76	95	114	133	152	171	190	209	228	247	266	285	304	323	342	361	380	399
L2	28	47	66	85	104	123	142	161	180	199	218	237	256	275	294	313	332	351	370	389



VK300 Series Specific Product Precautions

Be sure to read this before handling the products.
Refer to page 8 for safety instructions and pages 9 to 15 for 3/4/5 port solenoid valve precautions.

⚠ Caution

How to Wire DIN Terminal

● Connection

- Loosen the set screw and pull out the connector from the terminal block of the solenoid.
- Remove screw and insert screwdriver into the slit area near the bottom of terminal block to separate block and housing.
- Loosen the terminal screws (slotted screws) on the terminal block, insert the core of the lead wire into the terminal, and attach securely with the terminal screws.
- Tighten the ground nut to secure the cable.

⚠ Caution

Use caution in wiring because it will not meet the IP65 (enclosure) standard if you use the other cable than prescribed heavy-duty cable of size (ø3.5 to ø7).
Tighten the ground nut and set screw within the specified range of torque.

● Change of electrical entry (Orientation)

After separating terminal block and housing, the cable entry direction can be changed by attaching the housing in the desired direction (4 directions in 90 increments).
* In the case of w/ indicator light, avoid damaging the light with lead wire.

● Precautions

Plug a connector in or out vertically, never at an angle.

● Applicable cable

O.D.: ø3.5 to ø7
(Reference)
0.5 mm² 2 core and 3 core wires equivalent to JIS C 3306

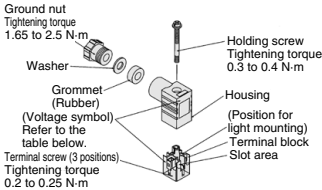

● Connector part no.: VK300-82-1

● Part no. of connector with indicator light

Rated voltage	Voltage symbol	Part no.
100 VAC	100V	VK300-82-2-01
110 VAC	110V	VK300-82-2-03
200 VAC	200V	VK300-82-2-02
220 VAC	220V	VK300-82-2-04
240 VAC	240V	VK300-82-2-07
6 VDC	6V	VK300-82-4-51
12 VDC	12V	VK300-82-4-06
24 VDC	24VD	VK300-82-3-05
48 VDC	48VD	VK300-82-3-53

● Circuit with indicator light

AC circuit diagram 12 VDC or less circuit diagram 24 VDC or more circuit diagram

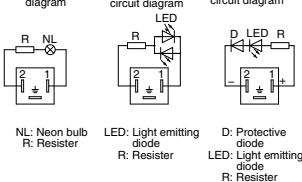

⚠ Caution

Light/Surge Voltage Suppressor

Rated voltage	Grommet (G)		DIN terminal (D)		Part No. (Symbol)
	Standard: Y, V, W	Continuous duty type (E)	Standard: Y, V, W	Continuous duty type (E)	
AC	With indicator light		None		S
	Without indicator light	None	None		Z
DC 24V 48V	With indicator light		None		S
	Without indicator light	None	None		Z
DC 6V 12V	With indicator light		None		S
	Without indicator light	None	None		Z

Precautions on connection of 24 V or more DC Grommet type should be connected as following: Red lead wire for (+) side, Black lead wire for (-) side respectively.

With the DIN terminal, connect the positive (+) side to the connector's no. 1 terminal, and the negative (-) side to the no. 2 terminal. [Refer to the marks on the terminal board.]

* For 12 VDC or below, there is no positive (+) or negative (-) directionality.

● Grommet type

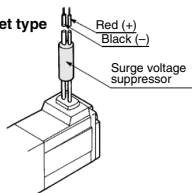

● DIN terminal type

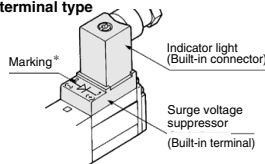

* Marking

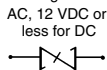

For 24 V or more

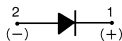

⚠ Warning

Valve Mounting Direction

When mounting a valve on the manifold base or sub-plate, etc., the mounting orientation is already decided. If mounted in a wrong direction, the equipment to be connected may result in malfunction. Refer to pages 1223 to 1227 for external dimensions in mounting.

Vacuum Spec. Type: VK33□V (VK33□W)

In contrast to the standard product, this vacuum specification valve has less air leakage at low pressures, a feature that should be taken into consideration when using this valve for vacuum applications.

⚠ Caution

- Since this valve has slight air leakage, it can not be used for holding vacuum (including positive pressure holding) in the pressure container.

Continuous Duty Type: VK33□E

Recommended for continuous duty with long time loading.

⚠ Caution

- This model is for continuous duty, not for high cycle rates. But even in low cycle rates, if energizing the valve more than once a day, please consult with SMC.
- Energizing solenoid should be done at least once in 30 days.

How to Calculate the Flow Rate

For obtaining the flow rate, refer to the **Web Catalog**.