

Fieldbus System (For Input/Output)

EX600 Series

Supports digital inputs/outputs, analog inputs/outputs, and IO-Link units



IP67

IO-Link unit compatible SI unit

New EtherNet/IP™

New EtherCAT

PROFINET

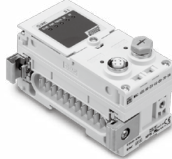

<Compatible Protocols>



DeviceNet

CC-Link

IO-Link



EtherNet/IP

EtherCAT

Made to order



ETHERNET POWERLINK

CC-Link IE Field

Please contact SMC for details on compatible products.

IO-Link unit

- 2 models (port class A and port class B)
- Diagnosis is possible from the upper level communication.
- The data can be accessed from via PC (setting tool).
- Device parameter setting function, Automatic saving/writing



Self-diagnosis function

Equipped with an input/output open/short-circuit detection function and an input/output signal ON/OFF counter function

Web server function*1

Status checks and forced output are possible via web browser.

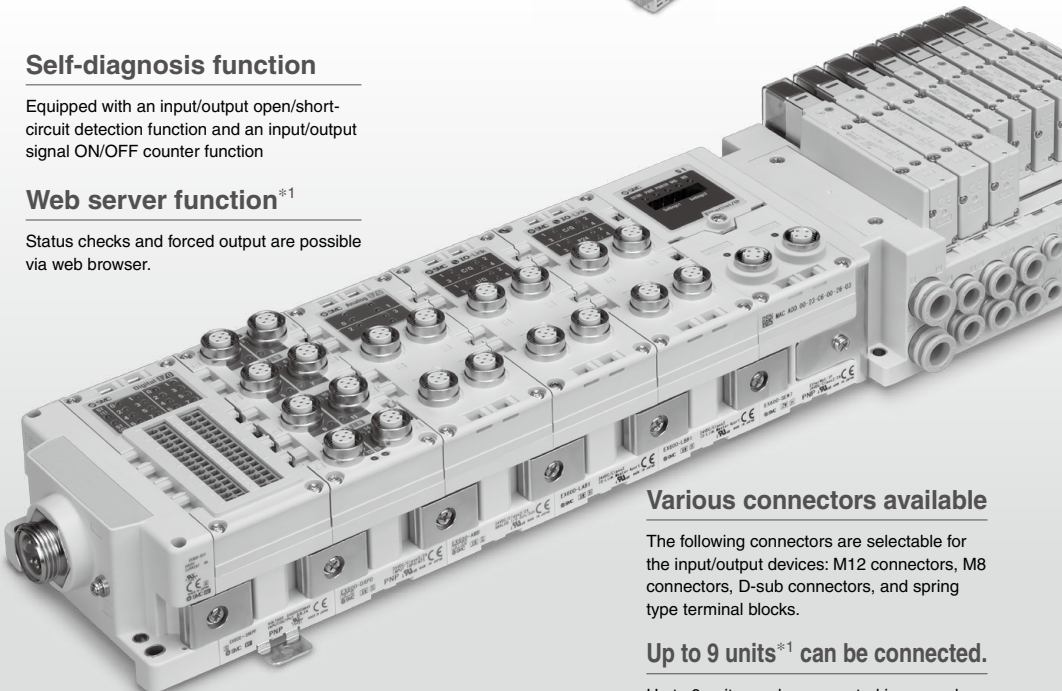

Various connectors available

The following connectors are selectable for the input/output devices: M12 connectors, M8 connectors, D-sub connectors, and spring type terminal blocks.

Up to 9 units*1 can be connected.

Up to 9 units can be connected in any order.

*1 Excludes SI units

Can be connected with digital, analog, and IO-Link units

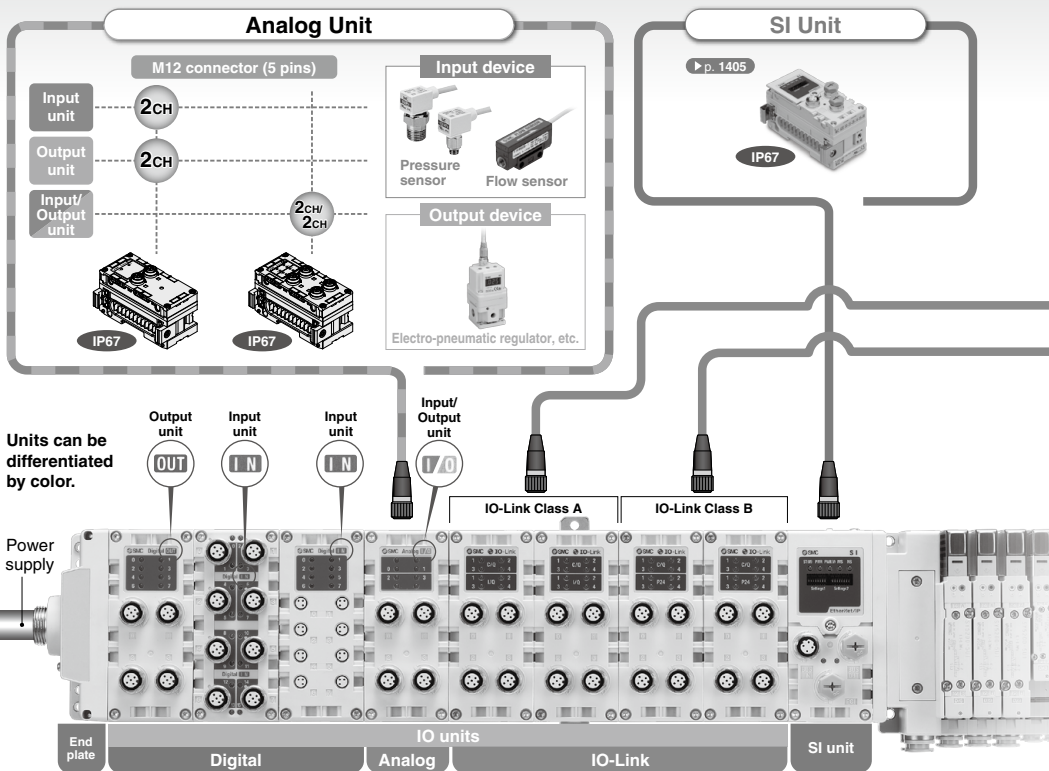

For detailed specifications of connectable devices, refer to the catalog of each device and select the right device for your application. If anything is unclear, please contact SMC.

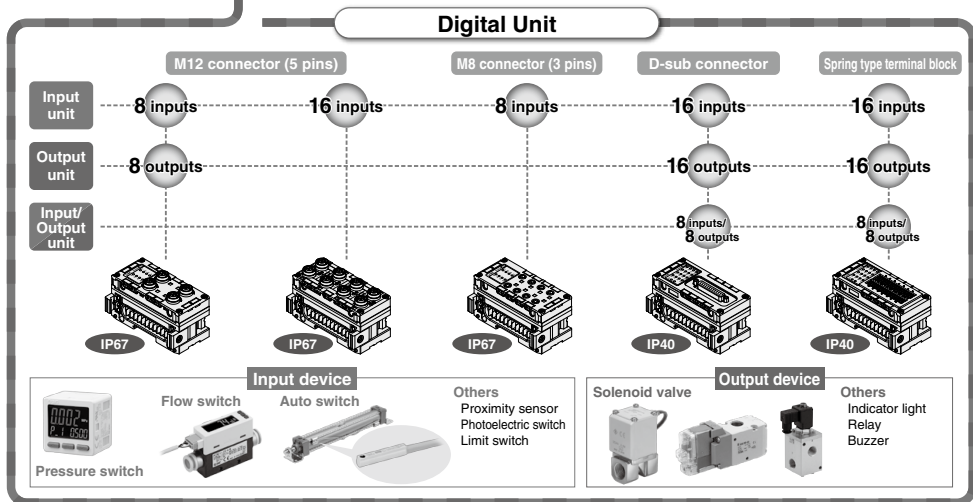

IO-Link Unit / Port Class A Devices

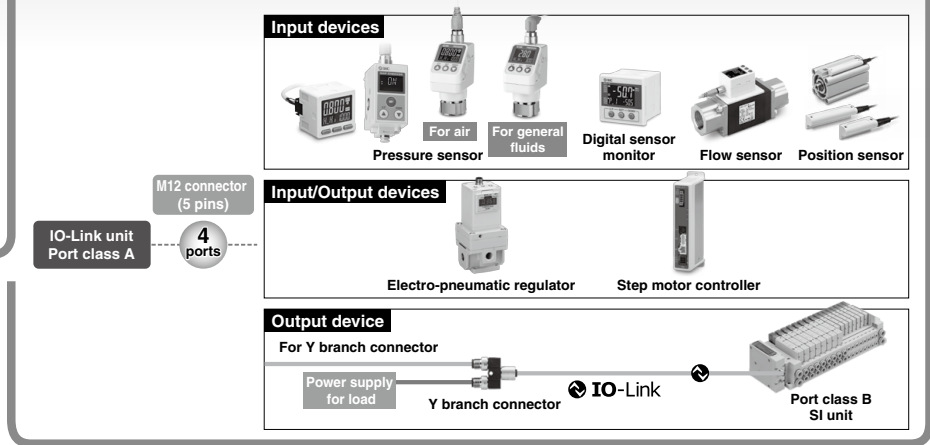

IO-Link Unit / Port Class B Device

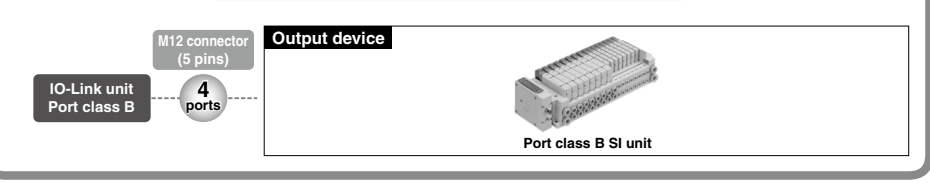

Connectable Solenoid Valve/Vacuum Unit

Applicable valve		Flow rate characteristics (4/2 → 5/3)		Max. number of solenoids	Power consumption [W]	Applicable cylinder size		
		C [dm ³ /(s·bar)]	b					
IP67 ^{*1}		CE UK CA c RU US	SY3000	1.6	0.19	32	0.35 (Standard) 0.1 (With power-saving circuit)	ø50
			SY5000	3.6	0.17			ø63
			SY7000	5.9	0.20			ø80
IP67 ^{*1, *3}		CE UK CA	JSY1000	0.91	0.48	32	0.2 (With power-saving circuit) 0.4 (Standard) 0.1 (With power-saving circuit)	ø40
			JSY3000	2.77	0.27			ø50
			JSY5000	6.59	0.22			ø80
IP40		CE UK CA	S0700 ^{*2}	0.37	0.39	32	0.35	ø25
IP67 ^{*1}			CE UK CA c RU US	SV1000 ^{*2}	1.1	0.35	32	0.6
IP67 ^{*1}	SV2000 ^{*2}	2.4		0.18	ø63			
	SV3000 ^{*2}	4.3		0.21	ø80			
	IP67 ^{*1}			CE UK CA	VQC1000	1.0		
VQC2000			3.2		0.30	ø63		
VQC4000			7.3		0.38	ø160		
VQC5000			17		0.31	ø180		
Applicable vacuum unit		Nozzle diameter [mm]		Max. number of solenoids	Power consumption [W]	Max. vacuum pressure [kPa]		
IP40		CE UK CA	ZK2□A				0.7	16
			1.0					
			1.2					
			1.5					

*1 Units with a D-sub connector or spring type terminal block are IP40.

*2 There are no manifold part number setting for the EX600-SPN3/4, EX600-SEN7/8, and EX600-SEC3/4. (Order it separately.)

*3 The JSY1000 is IP40.

IO-Link

IO-Link is a communication technology for sensors and actuators that is an international standard, IEC 61131-9.

This technology is used to send/receive device information such as manufacturer, product part number, parameters, and diagnostic data, as well as the control data including ON/OFF signals and measured values of the sensor, by connecting the IO-Link master and device in a 1:1 configuration.

IO-Link enables condition monitoring and error detection of the sensor and equipment, and it can contribute to the reduction of startup labor and recovery time and the realization of preventive and predictive maintenance.

Reduced design and startup labor

- Batch setting of device parameters from the upper level
- Remote check of device information
- Detection and remote unified check of device misconnection/non-connection

Minimum recovery time due to error detection

- Early detection of location where problem is occurring via communication
- Early obtaining of information on problem phenomenon via communication
- Early recovery during product replacement (automatic setting of device parameters)

Preventive and predictive maintenance through condition monitoring

- Monitors changes in measured values of a sensor during signal ON/OFF
- Monitors the number of device operations and automatically notifies when the set number of operations has been exceeded
- Remote monitoring of device and equipment conditions via communication

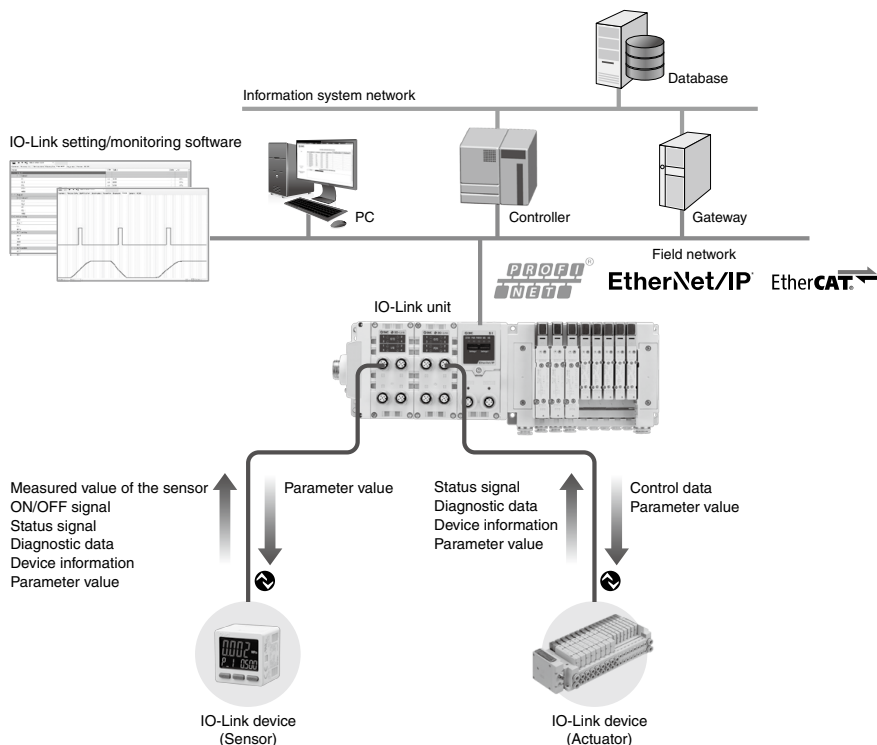

IO-Link System Configuration

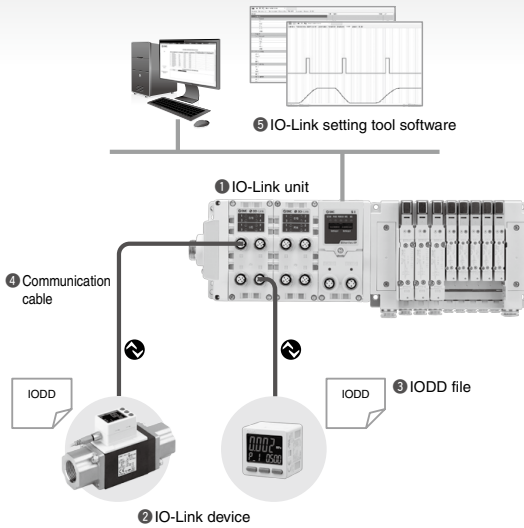

1 IO-Link unit

- Acts as a gateway between the IO-Link communication and the upper level communication

2 IO-Link device

- A sensor/actuator connecting to each port of the IO-Link unit in a 1:1 configuration

3 IODD file

- A file in which device properties and parameters are described
- Registered to the setting tool
- Provided by the device manufacturer

4 Communication cable

- A 4-wire or 5-wire general-purpose cable that is the same as the existing sensor cable (Unshielded cable)
- Max. cable length: 20 m

5 IO-Link setting tool (IO-Link Device Tool)

- Software for the setting and monitoring of an IO-Link unit/device
- *1 A setting tool compatible with the IO-Link units of every manufacturer is used for the SMC EX600 series IO-Link unit. (IO-Link Device Tool V5-PE (V5 or later only) manufactured by TMG Technologie und Engineering GmbH (hereinafter referred to as TMG))

IO-Link Interface

The connecting part between the IO-Link unit and the device is called a "port." Each port can be switched between "IO-Link mode" for digital communication and "standard I/O mode" for conventional contact input/output.

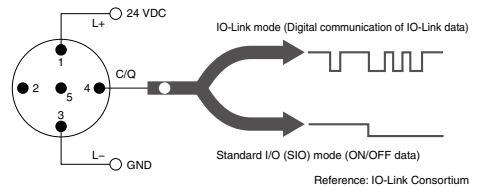

2 types of interfaces

There are two methods for power supply: one is for sensors, and the other is for actuators.

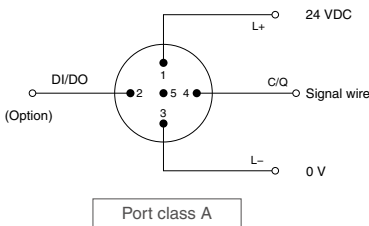

The control power supply wire and signal wire can be connected with one cable. (Mainly for sensors)

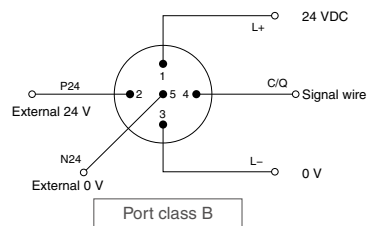

The control power supply wire, external power supply wire, and signal wire can be connected with one cable. (Mainly for actuators)

IO-Link Unit

■ Can be connected with digital, analog, and IO-Link unit units

Up to 9 IO-Link units can be connected. (36 IO-Link devices can be connected.)

Digital units, analog units, and IO-Link units can be mixed, and up to 9 units can be connected in any order.

4 IO-Link devices can be connected.

[Connectable SI unit]

PROFIBUS
NET

EtherNet/IP
EtherCAT

* For connectable SI units, refer to pages 1405, 1409, and 1410 of this catalog.

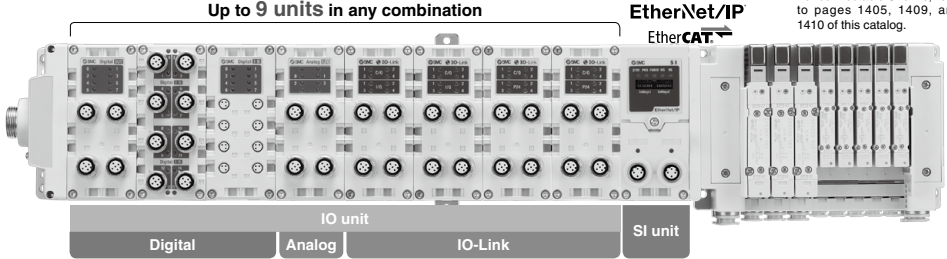

■ Supports both port class A and port class B

Port class A
IO-Link unit

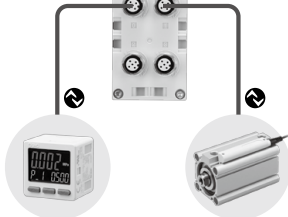

For connecting IO-Link sensors

Pressure sensors, flow sensors,
actuator position sensors,
electro-pneumatic regulators, etc.

Port class B
IO-Link unit

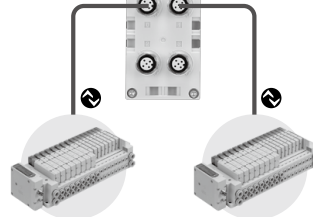

**For connecting IO-Link compatible
SI units (for valve driving)**

■ The data can be accessed from via PC (IO-Link setting tool).

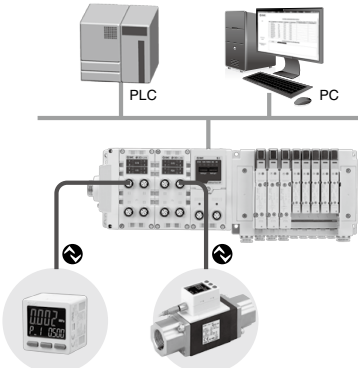

Setting screen

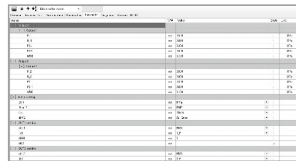

Monitoring screen

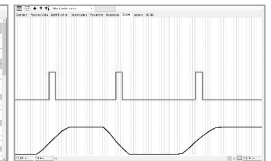

IO-Link units and IO-Link devices can be set and monitored from a PC without going through a PLC.

- Process data
- Unit parameters, Device parameters
- Unit information, Device information
- Port diagnosis, Device diagnosis

* The IO-Link setting tool is TMG's IO-Link Device Tool.

It can be downloaded for free from TMG's website. However, to use it for more than 30 days, a license key for the IO-Link Device Tool is required. (Refer to page 1437 for details.)

■ Diagnosis function

Diagnosis is possible from the upper level communication.

IO-Link unit (port) diagnostic information can be obtained via PLC program or PC (web browser).

Device diagnostic information can be obtained via PC (setting tool).

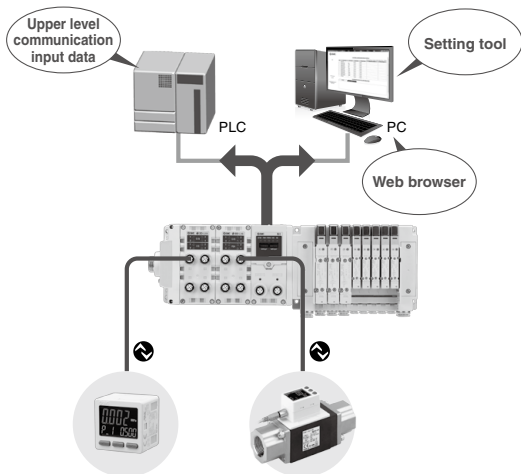

Items of IO-Link unit (port) diagnosis
Detection of port short-circuit
Detection of non-connected device
Detection of misconnected device (check error)
Notification of port misconfiguration (excessively large input/output data)
Conditions of diagnostic event (port, device)

Items of device diagnosis
Diagnostic results (problem phenomenon) received from devices are shown in event codes.

■ Device parameter setting function, Automatic saving/writing

The parameter setting of devices is possible from the upper level communication.

Parameter setting is possible via PC (setting tool).

It is also possible to use output data or message data via PLC program.

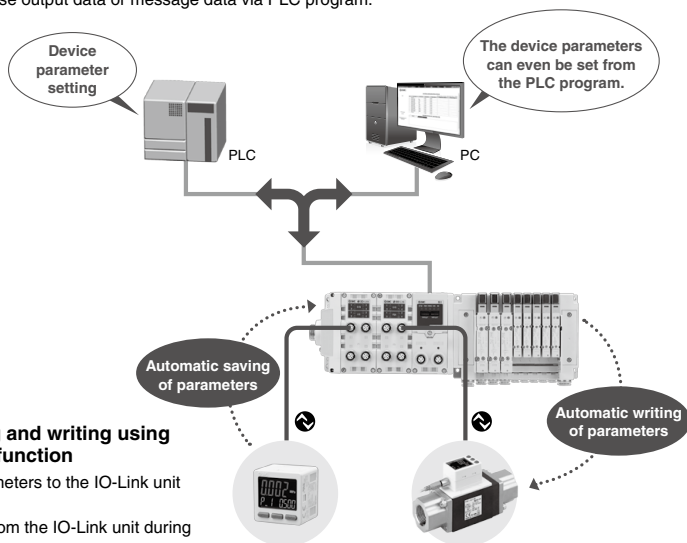

Automatic saving and writing using the data storage function

- Saves device parameters to the IO-Link unit automatically
- Automatic writing from the IO-Link unit during device replacement

EtherNet Fieldbus Functions

PROFINET (EX600-SPN3/4), EtherNet/IP™ (EX600-SEN3/4/7/8), and EtherCAT (EX600-SEC3/4) support the following functions.

Compatible topologies (Connection configuration)

The **EX600-SEN3/4/7/8**, **EX600-SPN3/4**, and **EX600-SEC3/4** support **star, linear, and ring** network topologies.

Linear type

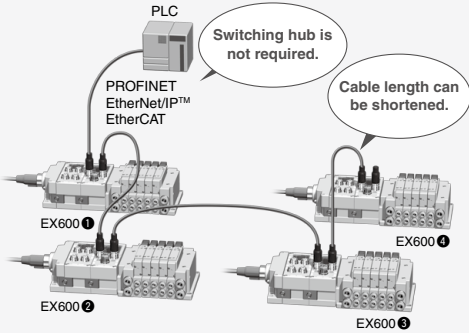

Ring type

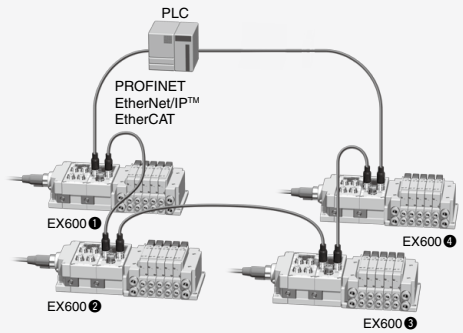

For ring networks, communication can be continued even if one of the communication cables in the network is disconnected or damaged. As the EX600-SEN3/4/7/8 supports Device Level Ring (DLR), and the EX600-SPN3/4 supports Media Redundancy Protocol (MRP), the disconnected point can be identified.

* In order to use DLR or MRP, the PLC must be able to support it.

Normal flow of data

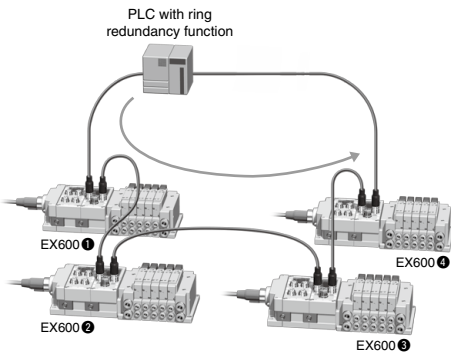

Data flow when the communication cable is disconnected

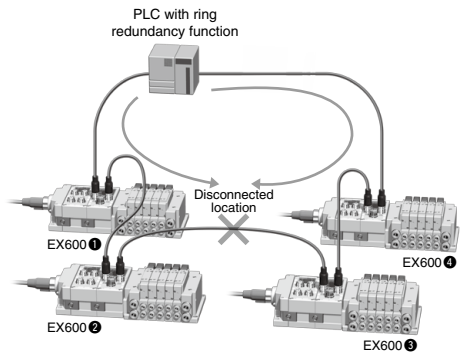

■ Supports the QuickConnect™ function and the Fast Start Up function

Time from power ON
to communication connection

10 s →

Approx.
0.5 s

In the case of a tool changer, it takes about 10 seconds for communication to be connected in some products after the power to the device installed on the tool is turned ON.

As the EX600-SEN3/4/7/8 supports the QuickConnect™ function, and the EX600-SPN3/4 supports the Fast Start Up function, communication connection in only approx. 0.5 s is possible.

* In order to use the QuickConnect™ function or the Fast Start Up function, the PLC must be able to support it.

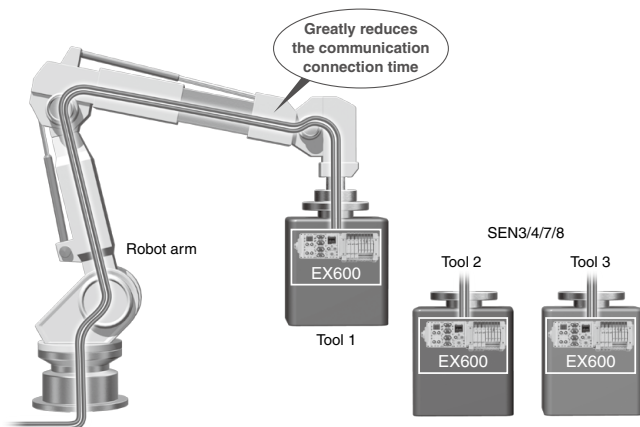

■ Built-in web server function

The EX600-SEN3/4/7/8, EX600-SPN3/4, and EX600-SEC3/4 have a built-in web server function, which enables status checks, parameter settings (EX600-SEN3/4/7/8 and EX600-SEC3/4), and forced output of the EX600 using general-purpose web browsers, such as Microsoft Edge. Start-up of the system and maintenance can be performed efficiently.

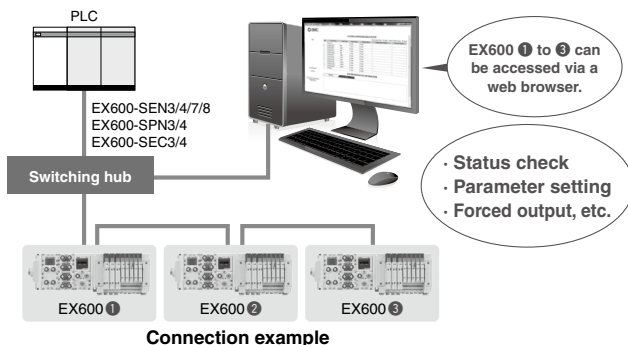

PROFINET Technology

■ System Redundancy S2

As the EX600-SPN3/4 supports System Redundancy S2, it can continue communication using the backup controller when the primary controller malfunctions. This allows for the prevention of problems caused by unexpected communication interruption.

* In order to use System Redundancy S2, the PLC must be able to support this function.

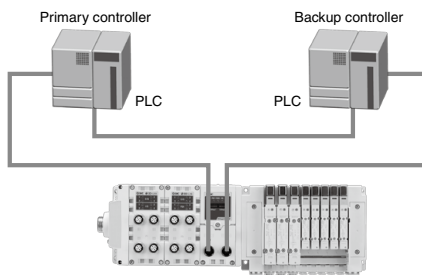

Fieldbus System EX600

■ D-sub connector

IP40

These units are capable of connection using a D-sub connector. There are three types of units: for digital input, output, and input/output. The digital output unit can be connected with an SMC manifold solenoid valve F kit (D-sub connector).

Manifold solenoid valves/Vacuum unit can be connected using a cable with a D-sub connector.

- SY series
- S0700 series
- SJ series
- SQ series
- SV series
- VQC series
- VQ series
- JSY series
- ZK2□A series

* Please limit the number of valve connections to 16 stations for single and 8 stations for double. Refer to the catalog of each product for pin assignment details.

VVZS3000-21A-□-X192 (Non-waterproof cable example)

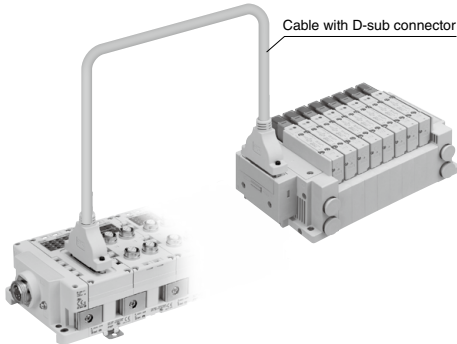

■ Spring type terminal block

IP40

These terminal block units are compatible with individual wiring configurations. There are three types of units: for digital input, output, and input/output. Wiring connection to a sensor connector box, etc., can be carried out easily using only a flat head screwdriver.

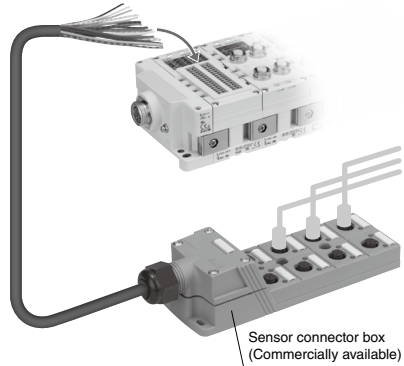

■ Digital input unit

IP67

This unit is for inputting a digital signal (ON/OFF signal). The signal of a 2-wire/3-wire auto switch attached to the actuator can be acquired to feedback a signal to the PLC. The control signal of an entire system can be managed by a Fieldbus system.

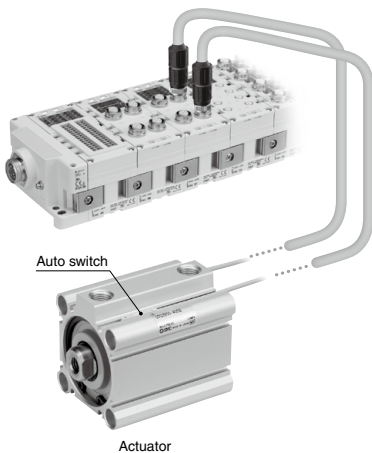

■ Analog input/output unit

IP67

These units are for inputting or outputting an analog signal (voltage/current). A single unit performs both input and output, allowing feedback control where analog signals are received from a pressure sensor and sent to a pressure controller. Installation space is minimized as well.

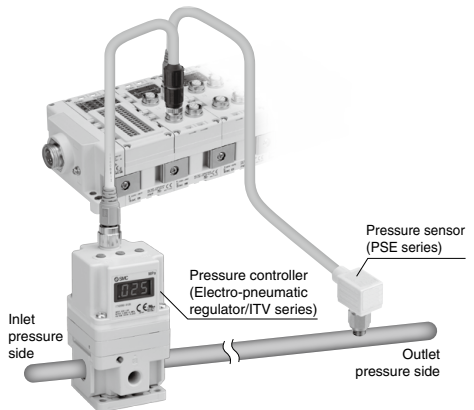

Self-diagnosis function

The following shows examples of the self-diagnosis function.

Short/Open-circuit detection

It is possible to detect short or open circuits of input devices such as electronic 2-wire switches and 3-wire switches and output devices such as solenoid valves. The location of the error can be identified by the indicator light and the network.

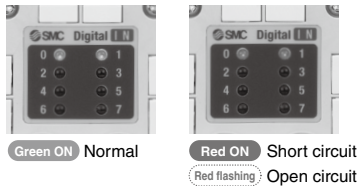

Counter function

It is possible to ascertain the maintenance period and identify the parts that require maintenance by an input and output signal ON/OFF counter function. When the counter function is enabled and a certain number of contact operations is reached, the display of the counter will flash in red.

* The counter function is not provided with analog units.

Individual units can be connected and removed one by one.

A unique clamping method is adopted to prevent screws from falling out.

Units can be separated easily by loosening the joint bracket.

Up to 9 units can be connected in any order.

* Excludes SI units

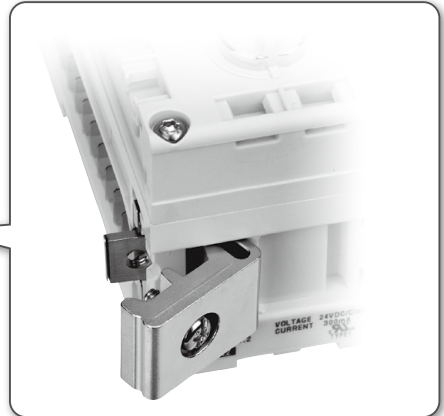
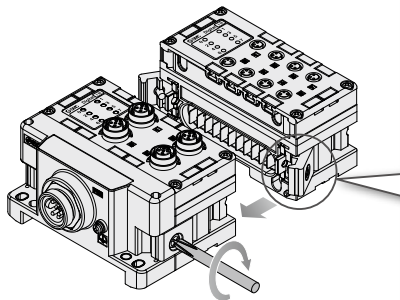

CONTENTS

Type 3 Integrated input-output type

Fieldbus System (For Input/Output)

EX600 Series

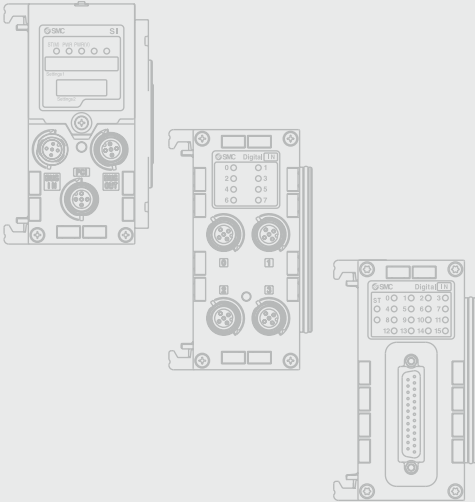
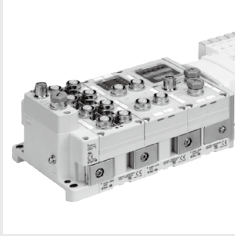

Parts Structure	p. 1405
How to Order	

SI Unit	p. 1405
Digital Input Unit	p. 1406
Digital Output Unit	p. 1406
Digital Input/Output Unit	p. 1406
Analog Input Unit	p. 1406
Analog Output Unit	p. 1406
Analog Input/Output Unit	p. 1407
IO-Link Unit	p. 1407
End Plate (D side)	p. 1407
Handheld Terminal	p. 1407

Specifications

All Units Common	p. 1408
SI Unit	p. 1408
Digital Input Unit	p. 1411
Digital Output Unit	p. 1412
Digital Input/Output Unit	p. 1412
Analog Input Unit	p. 1413
Analog Output Unit	p. 1413
Analog Input/Output Unit	p. 1414
IO-Link Unit	p. 1415
End Plate	p. 1415
Handheld Terminal	p. 1415

Dimensions

Dimensions	p. 1416
Parts Description	p. 1421
LED Indicator	p. 1423

Accessories

① End Plate Bracket	p. 1427
② Valve Plate	p. 1427
③ End Plate (U side)	p. 1428
④ Reinforcing Brace	p. 1428
⑤ Seal Cap (10 pcs.)	p. 1428
⑥ Marker (1 sheet, 88 pcs.)	p. 1428
⑦ Power Supply Cable (7/8 inch connector)	p. 1429
⑧ Power Supply Field-wireable Connector (7/8 inch)	p. 1429
⑨ Power Supply Cable (M12 connector, For EX600-ED2)	p. 1429
⑩ Power Supply Cable (M12 connector, For EX600-ED4/5)	p. 1430
⑪ Communication Cable	p. 1431
⑫ Field-wireable Communication Connector	p. 1435
⑬ I/O Cable with Connector, I/O Connector	p. 1436

Made to Order

① Ethernet POWERLINK compatible	p. 1438
② Modbus/TCP compatible	p. 1438
③ CC-Link IE Field compatible	p. 1438
Communication Cable	p. 1439

Specific Product Precautions	p. 1440
------------------------------------	---------

Fieldbus System For Input/Output

EX600 Series



Parts Structure

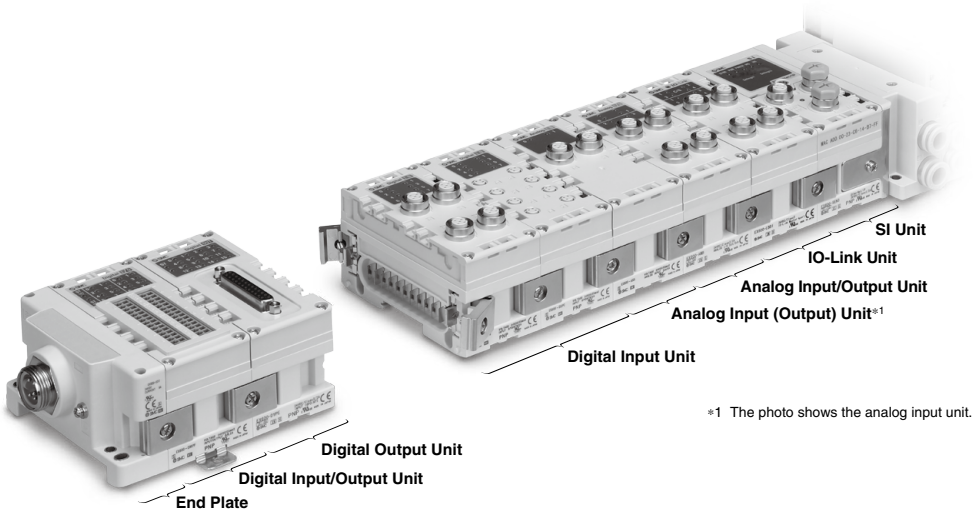

*1 The photo shows the analog input unit.

How to Order

SI Unit

EX600-S PR1A - []

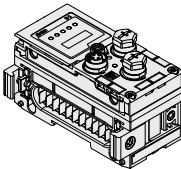

Specifications

Symbol	Protocol	Output type	Note
PR1A	PROFIBUS DP	PNP (Negative common)	—
PR2A		NPN (Positive common)	—
DN1A	DeviceNet®	PNP (Negative common)	—
DN2A		NPN (Positive common)	—
MJ1	CC-Link	PNP (Negative common)	—
MJ2		NPN (Positive common)	—
CF1-X60	CC-Link IE Field	PNP (Negative common)	(Made to order)
EN3	EtherNet/IP™	PNP (Negative common)	—
EN4		NPN(Positive common)	—
EN7		PNP (Negative common)	IO-Link unit
EN8		NPN(Positive common)	IO-Link unit
EC3	EtherCAT	PNP (Negative common)	IO-Link unit
EC4		NPN (Positive common)	IO-Link unit
PN1	PROFINET	PNP (Negative common)	—
PN2		NPN (Positive common)	—
PN3		PNP (Negative common)	IO-Link unit
PN4		NPN (Positive common)	IO-Link unit

• Made to order
(Refer to page 1438.)

Ethernet POWERLINK
Modbus TCP
CC-Link IE Field
NPN (Positive common)

How to Order

Digital Input Unit

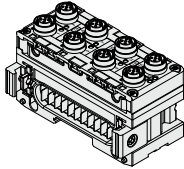

EX600-DX P D

Input type	
Symbol	Description
P	PNP
N	NPN

Number of inputs, open-circuit detection, and connector

Symbol	Number of inputs	Open-circuit detection	Connector
B	8 inputs	No	M12 connector (5 pins) 4 pcs.
C	8 inputs	No	M8 connector (3 pins) 8 pcs.
C1	8 inputs	Yes	M8 connector (3 pins) 8 pcs.
D	16 inputs	No	M12 connector (5 pins) 8 pcs.
E	16 inputs	No	D-sub connector (25 pins)
F	16 inputs	No	Spring type terminal block (32 pins)

Digital Output Unit

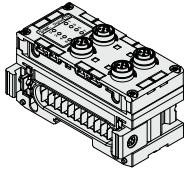

EX600-DY P B

Output type	
Symbol	Description
P	PNP
N	NPN

Number of outputs and connector

Symbol	Number of outputs	Connector
B	8 outputs	M12 connector (5 pins) 4 pcs.
E	16 outputs	D-sub connector (25 pins)
F	16 outputs	Spring type terminal block (32 pins)

Digital Input/Output Unit

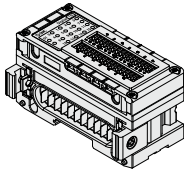

EX600-DM P F

Input/Output type	
Symbol	Description
P	PNP
N	NPN

Number of inputs/outputs and connector

Symbol	Number of inputs	Number of outputs	Connector
E	8 inputs	8 outputs	D-sub connector (25 pins)
F	8 inputs	8 outputs	Spring type terminal block (32 pins)

Analog Input Unit

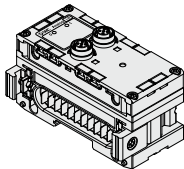

EX600-AX A

Analog input

Number of input channels and connector

Symbol	Number of input channels	Connector
A	2 channels	M12 connector (5 pins) 2 pcs.

Analog Output Unit

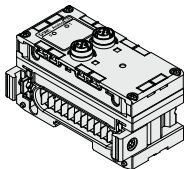

EX600-AY A

Analog output

Number of output channels and connector

Symbol	Number of output channels	Connector
A	2 channels	M12 connector (5 pins) 2 pcs.

How to Order

Analog Input/Output Unit **EX600-AM B**

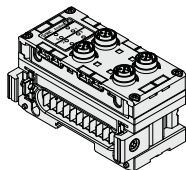

Analog input/output

Number of input/output channels and connector

Symbol	Number of input channels	Number of output channels	Connector
B	2 channels	2 channels	M12 connector (5 pins) 4 pcs.

IO-Link Unit

EX600-L A B 1

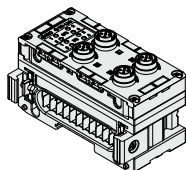

Port specification

Symbol	Description
A	Port class A
B	Port class B

Number of ports and connector

Symbol	Number of ports	Connector
B	4 ports	M12 connector (5 pins) 4 pcs.

Caution

The compatible SI unit models are as shown below. (Refer to page 1485.)
EtherNet/IP™: EX600-SEN7/8
PROFINET: EX600-SPN3/4
EtherCAT: EX600-SEC3/4

End Plate (D side)

EX600-ED 2 - 2

EX600-ED4/5 are not yet UL-compliant.

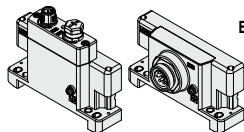

For M12

For 7/8 inch

End plate

End plate mounting position: D side

Power supply connector

Symbol	Power supply connector	Specifications
2	M12 (5 pins) B-coded	IN
3	7/8 inch (5 pins)	IN
4	M12 (4/5 pins) A-coded*1	IN/OUT
5	M12 (4/5 pins) A-coded*1	IN/OUT

*1 The pin layout for the "4" and "5" pin connectors is different.
Refer to the dimensions on page 1417.

Mounting method

Symbol	Description	Note
Nil	Without DIN rail mounting bracket	—
2	With DIN rail mounting bracket	For SV, S0700, and VQC series
3	With DIN rail mounting bracket	For SY, JSY, and ZK2□A series

* When the end plate (U side) is used, the symbol for the mounting method must be the same as the D side.

Handheld Terminal

EX600-HT1A - 3

Handheld terminals are not yet UL-compliant.

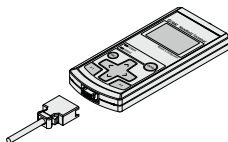

Version

Cable length

Symbol	Description
Nil	No cable
1	1 m
3	3 m

EX600 Series

Specifications

All Units Common Specifications

Environment	Operating temperature range	Operating: -10 to 50°C, Stored: -20 to 60°C
	Operating humidity range	35 to 85% RH (No condensation)
	Withstand voltage*1	500 VAC for 1 minute between external terminals and FE
	Insulation resistance*1	500 VDC, 10 MΩ or more between external terminals and FE

*1 Except handheld terminals

SI Unit (EX600-SPR□A) PROFIBUS

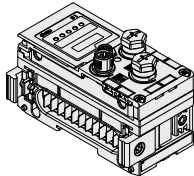

EX600-SPR□A

Model		EX600-SPR1A	EX600-SPR2A
Communication	Protocol	PROFIBUS DP (DP-V0)	
	Device type	PROFIBUS DP Slave	
	Communication speed	9.6/19.2/45.45/93.75/187.5/500 kbps	1.5/3/6/12 Mbps
	Configuration file	GSD file*2	
Occupation area (Number of inputs/outputs)		Max. (512 inputs/512 outputs)	
Terminating resistor		Internally implemented	
Internal current consumption (Power supply for Control/Input)		80 mA or less	
Output	Output type	Source/PNP (Negative common)	Sink/NPN (Positive common)
	Number of outputs	32 outputs (8/16/24/32 outputs selectable)	
	Load	Solenoid valve with surge voltage suppressor 24 VDC, 1.5 W or less (SMC)	
	Power supply	24 VDC, 2 A	
	Fail safe	HOLD/CLEAR/Forced power ON	
Protection		Short-circuit protection	
Enclosure		IP67 (Manifold assembly)	
Standards		CE/UKCA marking, UL (CSA)	
Weight		300 g	

*2 The configuration file can be downloaded from the SMC website: <https://www.smcworld.com>

SI Unit (EX600-SDN□A) DeviceNet®

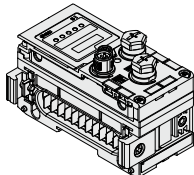

EX600-SDN□A

Model		EX600-SDN1A	EX600-SDN2A
Communication	Protocol	DeviceNet®: Volume 1 (Edition 2.1), Volume 3 (Edition 1.1)	
	Device type	Communication Adapter	
	Communication speed	125/250/500 kbps	
	Configuration file	EDS file*3	
Occupation area (Number of inputs/outputs)		Max. (512 inputs/512 outputs)	
Applicable messages		Duplicate MAC ID Check Message, Group 2 Only Unconnected Explicit Message, Explicit Message (Group 2), Poll I/O Message (Predefined M/S Connection set)	
Applicable function		QuickConnect™	
DeviceNet® power supply		11 to 25 VDC (Current consumption 50 mA or less)	
Internal current consumption (Power supply for Control/Input)		55 mA or less	
Output	Output type	Source/PNP (Negative common)	Sink/NPN (Positive common)
	Number of outputs	32 outputs (8/16/24/32 outputs selectable)	
	Load	Solenoid valve with surge voltage suppressor 24 VDC, 1.5 W or less (SMC)	
	Power supply	24 VDC, 2 A	
	Fail safe	HOLD/CLEAR/Forced power ON	
Protection		Short-circuit protection	
Enclosure		IP67 (Manifold assembly)	
Standards		CE/UKCA marking, UL (CSA)	
Weight		300 g	

*3 The configuration file can be downloaded from the SMC website: <https://www.smcworld.com>

SI Unit (EX600-SMJ□) CC-Link

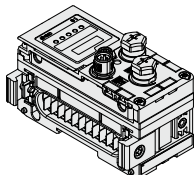

EX600-SMJ□

Model		EX600-SMJ1	EX600-SMJ2
Communication	Protocol	CC-Link (Ver. 1.10, Ver. 2.00)	
	Station type	Remote Device Station	
	Communication speed	156/625 kbps 2.5/5/10 Mbps	
	Configuration file	CSP+ file*4	
Occupation area (Number of inputs/outputs)		Max. (512 inputs/512 outputs) 1/2/3/4 stations occupied	
Internal current consumption (Power supply for Control/Input)		75 mA or less	
Output	Output type	Source/PNP (Negative common)	Sink/NPN (Positive common)
	Number of outputs	32 outputs (8/16/24/32 outputs selectable)	
	Load	Solenoid valve with surge voltage suppressor 24 VDC, 1.5 W or less (SMC)	
	Power supply	24 VDC, 2 A	
	Fail safe	HOLD/CLEAR/Forced power ON	
Protection		Short-circuit protection	
Enclosure		IP67 (Manifold assembly)	
Standards		CE/UKCA marking, UL (CSA)	
Weight		300 g	

*4 The configuration file can be downloaded from the SMC website: <https://www.smcworld.com>

Specifications

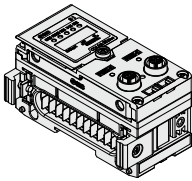

EX600-SCF1-X60

SI Unit (EX600-SCF1-X60) CC-Link IE Field

Model		EX600-SCF1-X60*1
Communication	Protocol	CC-Link IE Field
	Station type	Intelligent Device Station
	Communication speed	1 Gbps
	Allowable station number setting	1 to 120
	Allowable network number setting	1 to 239
	Transmission method	Cyclic transmission
	Configuration file	CSP+ file*2
Occupied input size	RX: 32 to 176 bits	
	RW: 32 to 608 words	
Occupied output size	RY: 32 to 176 bits	
	RW: 32 to 608 words	
Internal current consumption (Power supply for Control/Input)		140 mA or less
Output	Output type	Source/PNP (Negative common)
	Number of outputs	32 outputs
	Load	Solenoid valve with surge voltage suppressor 24 VDC, 1.0 W or less (SMC)
	Power supply	24 VDC, 2 A
	Fail safe	HOLD/CLEAR/Forced power ON
	Protection	Short-circuit protection
Enclosure		IP67 (Manifold assembly)
Standards		CE/UKCA marking
Weight		300 g

*1 For details on this product, refer to the SMC website.

*2 The configuration file can be downloaded from the SMC website: <https://www.smcworld.com>

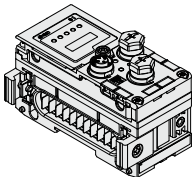

EX600-SEN3/4

SI Unit (EX600-SEN□) EtherNet/IP™

Model		EX600-SEN3	EX600-SEN4	EX600-SEN7	EX600-SEN8	
Communication	Protocol	EtherNet/IP™ (Conformance version: Composite 11)		EtherNet/IP™ (Conformance version: Composite 18)		
	Communication speed	10/100 Mbps				
	Communication method	Full duplex/Half duplex				
	Configuration file	EDS file*3				
	IP address setting range	SI Unit switch settings: 192.168.0 or 1.1 to 254 Through DHCP server: Optional address				
	Device information	Vendor ID: 7 (SMC Corporation)	Vendor ID: 7 (SMC Corporation)		Vendor ID: 7 (SMC Corporation)	
		Device type: 12 (Communication Adapter) Product code: 203	Device type: 12 (Communication Adapter) Product code: 258		Device type: 12 (Communication Adapter) Product code: 258	
QuickConnect	●	●	●	●		
DLR	●	●	●	●		
Web server function	●	●	●	●		
IO-Link unit		—		●		
Internal current consumption (Power supply for Control/Input)		120 mA or less				
Output	Output type	Source/PNP (Negative common)	Sink/NPN (Positive common)	Source/PNP (Negative common)	Sink/NPN (Positive common)	
	Number of outputs	32 outputs				
	Load	Solenoid valve with surge voltage suppressor 24 VDC, 1.0 W or less (SMC)				
	Power supply	24 VDC, 2 A				
	Fail safe	HOLD/CLEAR/Forced power ON				
	Protection	Short-circuit protection				
Enclosure		IP67 (Manifold assembly)				
Standards		CE/UKCA marking, UL (CSA)				
Weight		300 g				

*3 The configuration file can be downloaded from the SMC website: <https://www.smcworld.com>

* The occupation area (number of points) varies depending on the type of units and number of stations to be connected.

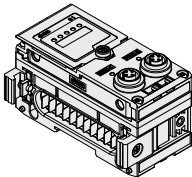

EX600-SEN7/8

EX600 Series

Specifications

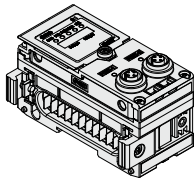

EX600-SEC3/4

SI Unit (EX600-SEC□) EtherCAT

Model		EX600-SEC3	EX600-SEC4
Communication	Protocol	EtherCAT (Conformance Test Record V.2.3.0)	
	Communication speed	100 Mbps	
	Configuration file	XML file*1	
	Web server function	●	
	IO-Link unit	●	
Internal current consumption (Power supply for Control/Input)		120 mA or less	
Output	Output type	Source/PNP (Negative common)	Sink/NPN (Positive common)
	Number of outputs	32 outputs (8/16/24/32 outputs selectable)	
	Load	Solenoid valve with surge voltage suppressor 24 VDC, 1.0 W or less (SMC)	
	Power supply	24 VDC, 2 A	
	Fail safe	HOLD/CLEAR/Forced power ON	
	Protection	Short-circuit protection	
Enclosure		IP67 (Manifold assembly)	
Standards		CE/UKCA marking, UL (CSA)	
Weight		300 g	

*1 The configuration file can be downloaded from the SMC website: <https://www.smcworld.com>

* The occupation area (number of points) varies depending on the type of units and number of stations to be connected.

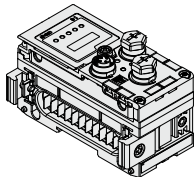

EX600-SPN1/2

SI Unit (EX600-SPN□) PROFINET

Model		EX600-SPN1	EX600-SPN2	EX600-SPN3	EX600-SPN4
Communication	Protocol	PROFINET IO (Conformance Class B)		PROFINET IO (Conformance Class C)	
	Communication speed	100 Mbps			
	Configuration file	GSDML file*2			
	Fast Start Up (Communication connection time)	● (Approx. 2 s)		● (Approx. 500 ms)	
	MRP	—		●	
	System Redundancy S2	—		●	
IO-Link unit	Web server function	—		●	
	IO-Link unit	—		●	
Internal current consumption (Power supply for Control/Input)		120 mA or less			
Output	Output type	Source/PNP (Negative common)	Sink/NPN (Positive common)	Source/PNP (Negative common)	Sink/NPN (Positive common)
	Number of outputs	32 outputs			
	Load	Solenoid valve with surge voltage suppressor 24 VDC, 1.0 W or less (SMC)			
	Fail safe	HOLD/CLEAR/Forced power ON			
	Protection	Short-circuit protection			
	Enclosure	IP67 (Manifold assembly)			
Standards		CE/UKCA marking, UL (CSA)			
Weight		300 g			

*2 The configuration file can be downloaded from the SMC website: <https://www.smcworld.com>

* The occupation area (number of points) varies depending on the type of units and number of stations to be connected.

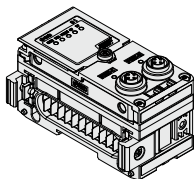

EX600-SPN3/4

Specifications

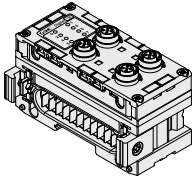

EX600-DX□B

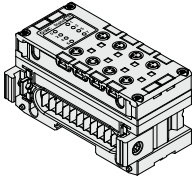

EX600-DX□C1

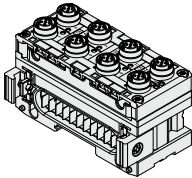

EX600-DX□C2

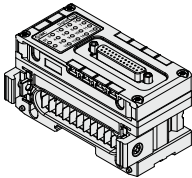

EX600-DX□D

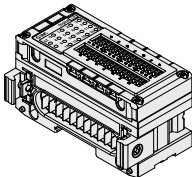

EX600-DX□E



EX600-DX□F

Digital Input Unit

Model		EX600-DXPB	EX600-DXNB	EX600-DXPC□	EX600-DXNC□	EX600-DXPD	EX600-DXND	
Input	Input type	PNP	NPN	PNP	NPN	PNP	NPN	
	Input connector	M12 (5-pin) socket*1		M8 (3-pin) socket*3		M12 (5-pin) socket*1		
	Number of inputs	8 inputs (2 inputs/Connector)		8 inputs (1 input/Connector)		16 inputs (2 inputs/Connector)		
	Supplied voltage	24 VDC						
	Max. supplied current	0.5 A/Connector 2 A/Unit		0.25 A/Connector 2 A/Unit		0.5 A/Connector 2 A/Unit		
	Protection	Short-circuit protection						
	Input current (at 24 VDC)	9 mA or less						
	ON voltage	17 V or more (At NPN input, between the pin for input terminal and supplied voltage of +24 V) (At PNP input, between the pin for input terminal and supplied voltage of 0 V)						
	OFF voltage	5 V or less (At NPN input, between the pin for input terminal and supplied voltage of +24 V) (At PNP input, between the pin for input terminal and supplied voltage of 0 V)						
	Open circuit detection current	2 wires	—		0.5 mA/Input*2		—	
		3 wires	—		0.5 mA/Connector*2		—	
	Current consumption	50 mA or less		55 mA or less		70 mA or less		
	Enclosure	IP67 (Manifold assembly)						
	Standards	CE/UKCA marking, UL (CSA)						
Weight	300 g		275 g		340 g			

*1 M12 (4-pin) connector can be connected.

*2 Function only applies to the EX600-DX□C1.

*3 When connecting the M8 plug connector, the tightening torque must be 0.2 N·m ±10%. If tightened with an excessive tightening torque, this may cause the connector thread of the unit to break.

Model		EX600-DXPE	EX600-DXNE	EX600-DXPF	EX600-DXNF	
Input	Input type	PNP	NPN	PNP	NPN	
	Input connector	D-sub socket (25 pins) Lock screw: No.4-40 UNC		Spring type terminal block (32 pins)		
	Number of inputs	16 inputs			16 inputs (2 inputs x 8 blocks)	
	Supplied voltage	24 VDC				
	Max. supplied current	2 A/Unit			0.5 A/Block 2 A/Unit	
	Protection	Short-circuit protection				
	Input current (at 24 VDC)	5 mA or less				
	ON voltage	17 V or more (At NPN input, between the pin for input terminal and supplied voltage of +24 V) (At PNP input, between the pin for input terminal and supplied voltage of 0 V)				
	OFF voltage	5 V or less (At NPN input, between the pin for input terminal and supplied voltage of +24 V) (At PNP input, between the pin for input terminal and supplied voltage of 0 V)				
	Applicable wire	—		0.08 to 1.5 mm ² (AWG16 to 28)		
	Current consumption	50 mA or less			55 mA or less	
	Enclosure	IP40 (Manifold assembly)				
	Standards	CE/UKCA marking, UL (CSA)				
	Weight	300 g				

EX600 Series

Specifications

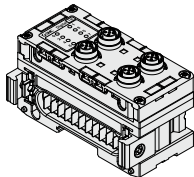

EX600-DY□B

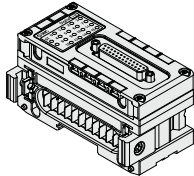

EX600-DY□E
EX600-DM□E

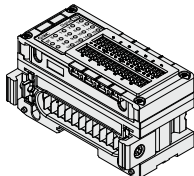

EX600-DY□F
EX600-DM□F

Digital Output Unit

Model		EX600-DYPB	EX600-DYNB	EX600-DYPE	EX600-DYNE	EX600-DYPF	EX600-DYNF
Output	Output type	PNP	NPN	PNP	NPN	PNP	NPN
	Output connector	M12 (5-pin) socket*1		D-sub socket (25 pins) Lock screw: No.4-40 UNC		Spring type terminal block (32 pins)	
	Number of outputs	8 outputs (2 outputs/Connector)		16 outputs		16 outputs (2 outputs x 8 blocks)	
	Supplied voltage	24 VDC					
	Max. load current	0.5 A/Output 2 A/Unit					
	Protection	Short-circuit protection					
Applicable wire	—		—		0.08 to 1.5 mm ² (AWG16 to 28)		
Current consumption	50 mA or less						
Enclosure	IP67 (Manifold assembly)			IP40 (Manifold assembly)			
Standards	CE/UKCA marking, UL (CSA)						
Weight	300 g						

*1 M12 (4-pin) connector can be connected.

Digital Input/Output Unit

Model		EX600-DMPE	EX600-DMNE	EX600-DMPF	EX600-DMNF
Input/Output type		PNP	NPN	PNP	NPN
Connector		D-sub socket (25 pins) Lock screw: No.4-40 UNC		Spring type terminal block (32 pins)	
Input	Number of inputs	8 inputs		8 inputs (2 inputs x 4 blocks)	
	Supplied voltage	24 VDC			
	Max. supplied current	2 A/Unit		0.5 A/Block 2 A/Unit	
	Protection	Short-circuit protection			
	Input current (at 24 VDC)	5 mA or less			
	ON voltage	17 V or more (At NPN input, between the pin for input terminal and supplied voltage of +24 V) (At PNP input, between the pin for input terminal and supplied voltage of 0 V)			
OFF voltage	5 V or less (At NPN input, between the pin for input terminal and supplied voltage of +24 V) (At PNP input, between the pin for input terminal and supplied voltage of 0 V)				
Output	Number of outputs	8 outputs		8 outputs (2 outputs x 4 blocks)	
	Supplied voltage	24 VDC			
	Max. load current	0.5 A/Output 2 A/Unit			
	Protection	Short-circuit protection			
	Applicable wire	—		0.08 to 1.5 mm ² (AWG16 to 28)	
Current consumption	50 mA or less		60 mA or less		
Enclosure	IP40 (Manifold assembly)				
Standards	CE/UKCA marking, UL (CSA)				
Weight	300 g				

Specifications

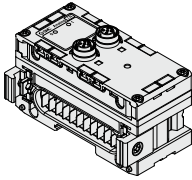

EX600-AXA

Analog Input Unit

Model		EX600-AXA		
Input	Input type	Voltage input	Current input	
	Input connector	M12 (5-pin) socket*1		
	Input channel	2 channels (1 channel/Connector)		
	Supplied voltage	24 VDC		
	Max. supplied current	0.5 A/Connector		
	Protection	Short-circuit protection		
	Input signal range	12 bit resolution	0 to 10 V, 1 to 5 V, 0 to 5 V	0 to 20 mA, 4 to 20 mA
		16 bit resolution	-10 to 10 V, -5 to 5 V	-20 to 20 mA
	Max. rated input signal	±15 V	±22 mA*2	
	Input impedance	100 kΩ	50 Ω	
	Linearity (25°C)	±0.05% F.S.		
	Repeatability (25°C)	±0.15% F.S.		
	Absolute accuracy (25°C)	±0.5% F.S.	±0.6% F.S.	
	Current consumption	70 mA or less		
Enclosure	IP67 (Manifold assembly)			
Standards	CE/UKCA marking, UL (CSA)			
Weight	290 g			

*1 M12 (4-pin) connector can be connected.

*2 When input signal exceeds 22 mA, the protection function activates and the input signal is interrupted.

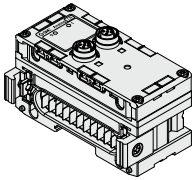

EX600-AYA

Analog Output Unit

Model		EX600-AYA		
Output	Output type	Voltage output	Current output	
	Output connector	M12 (5-pin) socket*3		
	Output channel	2 channels (1 channel/Connector)		
	Supplied voltage	24 VDC		
	Max. load current	0.5 A/Connector		
	Protection	Short-circuit protection		
	Output signal range	12 bit resolution	0 to 10 V, 1 to 5 V, 0 to 5 V	0 to 20 mA, 4 to 20 mA
		Load impedance	1 kΩ or more	600 Ω or less
	Linearity (25°C)	±0.05% F.S.		
	Repeatability (25°C)	±0.15% F.S.		
	Absolute accuracy (25°C)	±0.5% F.S.	±0.6% F.S.	
	Current consumption	70 mA or less		
	Enclosure	IP67 (Manifold assembly)		
	Standards	CE/UKCA marking, UL (CSA)		
Weight	290 g			

*3 M12 (4-pin) connector can be connected.

EX600 Series

Specifications

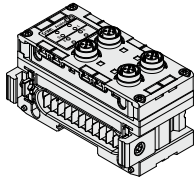

EX600-AMB

Analog Input/Output Unit

Model		EX600-AMB	
Input type		Voltage input	Current input
Input connector		M12 (5-pin) socket*1	
Input channel		2 channels (1 channel/Connector)	
Supplied voltage		24 VDC	
Max. supplied current		0.5 A/Connector	
Protection		Short-circuit protection	
Input	Input signal range	12 bit resolution	0 to 10 V, 1 to 5 V, 0 to 5 V
	Max. rated input signal		0 to 20 mA, 4 to 20 mA
	Input impedance		15 V
	Linearity (25°C)		22 mA*2
	Repeatability (25°C)		100 kΩ
	Absolute accuracy (25°C)		250 Ω
	Linearity (25°C)		±0.05% F.S.
Repeatability (25°C)		±0.15% F.S.	
Absolute accuracy (25°C)		±0.5% F.S.	±0.6% F.S.
Output type		Voltage output	Current output
Output connector		M12 (5-pin) socket*1	
Output channel		2 channels (1 channel/Connector)	
Supplied voltage		24 VDC	
Max. load current		0.5 A/Connector	
Protection		Short-circuit protection	
Output	Output signal range	12 bit resolution	0 to 10 V, 1 to 5 V, 0 to 5 V
	Load impedance		0 to 20 mA, 4 to 20 mA
	Linearity (25°C)		1 kΩ or more
	Repeatability (25°C)		600 Ω or less
	Absolute accuracy (25°C)		±0.05% F.S.
	Current consumption		±0.15% F.S.
	Enclosure		±0.5% F.S.
Standards		100 mA or less	
Weight		IP67 (Manifold assembly)	
		CE/UKCA marking, UL (CSA)	
		300 g	

*1 M12 (4-pin) connector can be connected.

*2 When input signal exceeds 22 mA, the protection function activates and the input signal is interrupted.

Specifications

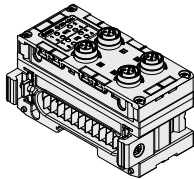

EX600-L□B1

IO-Link Unit

Model		EX600-LAB1	EX600-LBB1
IO-Link version		Version 1.1	
IO-Link port class		Class A	Class B
Communication speed		COM1 (4.8 kBaud) COM2 (38.4 kBaud) COM3 (230.4 kBaud) * Changes automatically according to the connected device	
Number of IO-Link ports		4	
Compatible SI unit (Protocol)		EX600-SEN7/8 (EtherNet/IP™) EX600-SPN3/4 (PROFINET) EX600-SEC3/4 (EtherCAT)	
Max. supply current	Device power supply (L+)	0.5 A/Connector (2 A/Unit)	0.5 A/Connector (1 A/Unit)
	External power supply (P24)	—	1.6 A/Connector (3 A/Unit)
Input	Pin no.	2	4
	Input type	PNP	
	Protection	Short-circuit protection	
	Rated input current	Approx. 2.5 mA	Approx. 5.8 mA
	ON voltage	13 V or more	
Output	OFF voltage	8 V or less	
	Pin no.	4	
	Output type	PNP	
	Max. load current (C/Q line)	0.25 A/Output (Supplied from the power supply for control/input)	
	Protection	Short-circuit protection	
Current consumption		50 mA or less	
Enclosure		IP67 (Manifold assembly)	
Standards		CE/UKCA marking, UL (CSA)	
Weight		320 g	

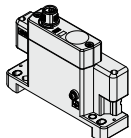

EX600-ED2□

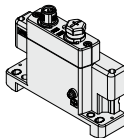

EX600-ED4/5□

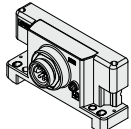

EX600-ED3□

End Plate

Model		EX600-ED2□	EX600-ED3□	EX600-ED4/5□	
Power specifications	PWR IN	M12 (5-pin) plug	7/8 inch (5-pin) plug	M12 (4-pin) plug	
	PWR OUT	—	—	M12 (5-pin) socket	
	Rated voltage	Power supply for control/input	24 VDC ±10%		
		Power supply for output	24 VDC +10/-5%		
Rated current	Power supply for control/input	Max. 2 A	Max. 8 A	Max. 4 A	
	Power supply for output				
Enclosure		IP67 (Manifold assembly)			
Standards*1		CE/UKCA marking, UL (CSA)			
Weight		170 g	175 g	170 g	

*1 The EX600-ED4/5□ is not compliant with UL (CSA) standards.

Handheld Terminal

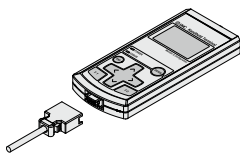

EX600-HT1A□

Model		EX600-HT1A□
Power supply	Power supplied from SI unit connector (24 VDC)	
Current consumption	50 mA or less	
Display	LCD with backlight	
Connection cable	Handheld terminal cable (1 m ... EX600-AC010-1, 3 m ... EX600-AC030-1)	
Enclosure	IP20	
Standards*1	CE/UKCA marking	
Weight	160 g	

*1 The handheld terminal is not compliant with UL (CSA) standards.

* Cannot be used with the EX600-SEN7/8, EX600-SPN3/4, EX600-SEC3/4, and EX600-L□B1

EX600 Series

Dimensions

SI Unit

EX600-SPR□A
EX600-SDN□A
EX600-SMJ□

EX600-SEN3/4
EX600-SPN1/2

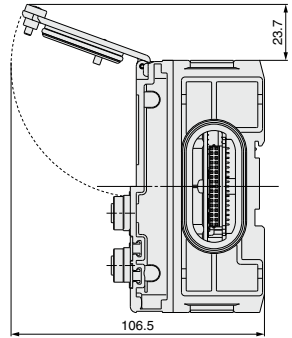
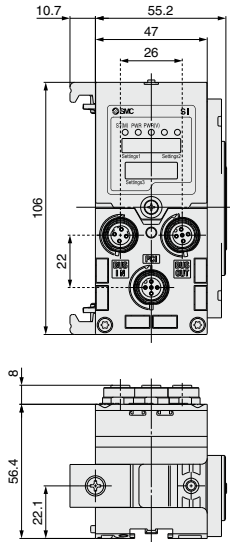
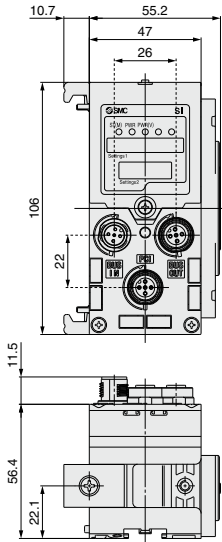

EX600-SEN7/8
EX600-SPN3/4
EX600-SEC3/4

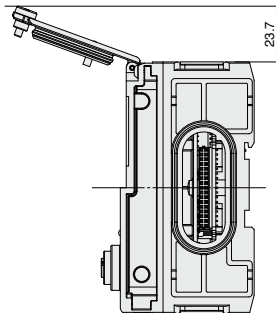
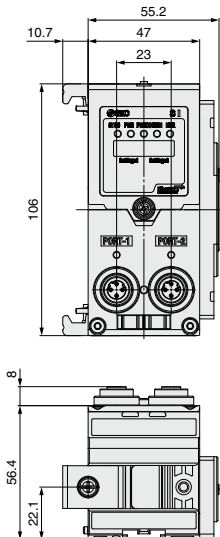

Dimensions

End Plate (D side)

EX600-ED2

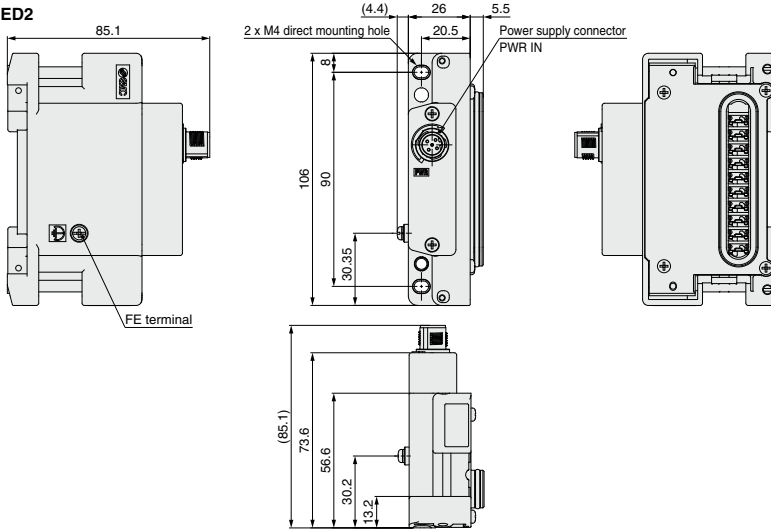

EX600-ED4/ED5

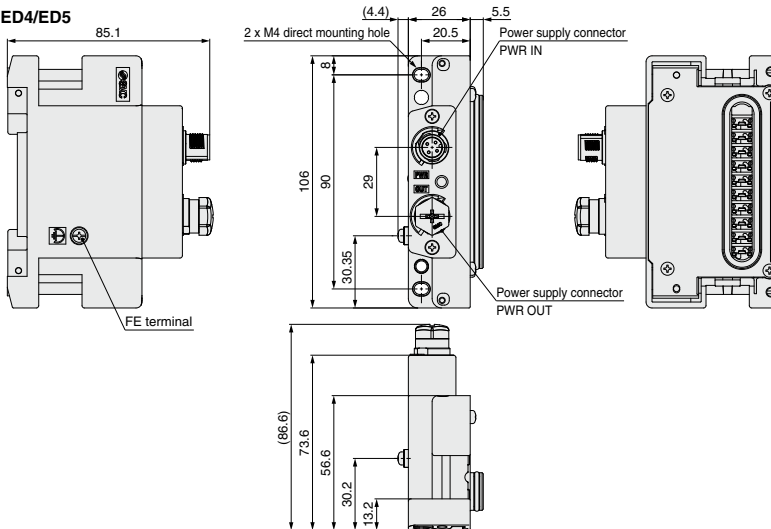

Power supply connector PWR IN: M12 5-pin plug, B-coded

Configuration	Pin no.	Description
	1	24 V (for output)
	2	0 V (for output)
	3	24 V (for control/input)
	4	0 V (for control/input)
	5	FE

Power supply connector PWR IN: M12 4-pin plug, A-coded

Configuration	Pin no.	Description	Pin no.	Description
	1	24 V (for control/input)	1	24 V (for output)
	2	24 V (for output)	2	0 V (for output)
	3	0 V (for control/input)	3	24 V (for control/input)
	4	0 V (for output)	4	0 V (for control/input)

Power supply connector PWR OUT: M12 5-pin socket, A-coded

Configuration	Pin no.	Description	Pin no.	Description
	1	24 V (for control/input)	1	24 V (for output)
	2	24 V (for output)	2	0 V (for output)
	3	0 V (for control/input)	3	24 V (for control/input)
	4	0 V (for output)	4	0 V (for control/input)
	5	Unused	5	Unused

EX600 Series

Dimensions

End Plate (D side)

EX600-ED3

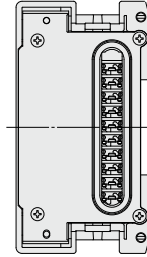
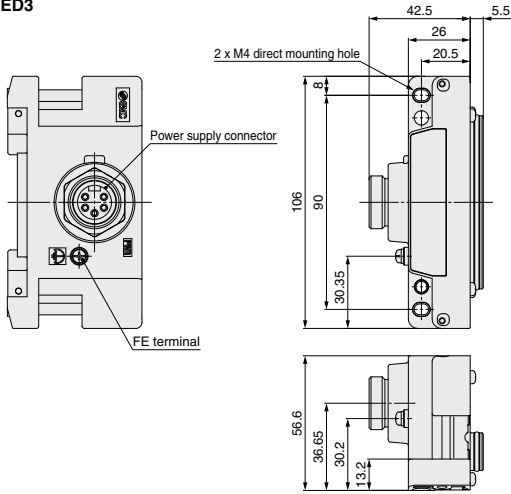

Power supply connector PWR: 7/8 inch 5-pin plug

Configuration	Pin no.	Description
	1	0 V (for output)
	2	0 V (for control/input)
	3	FE
	4	24 V (for control/input)
	5	24 V (for output)

Dimensions

Digital Unit

EX600-DX□B
EX600-DY□B

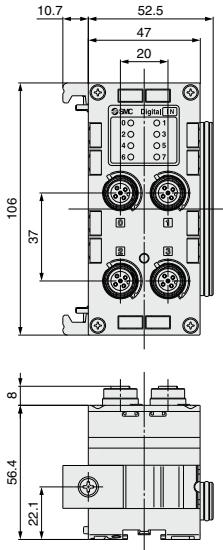

EX600-DX□C

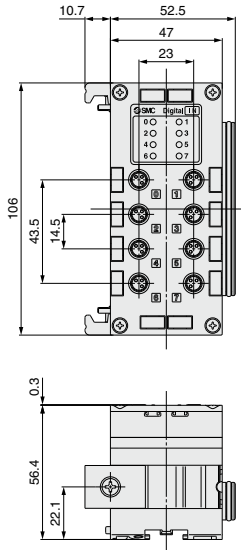

EX600-DX□D

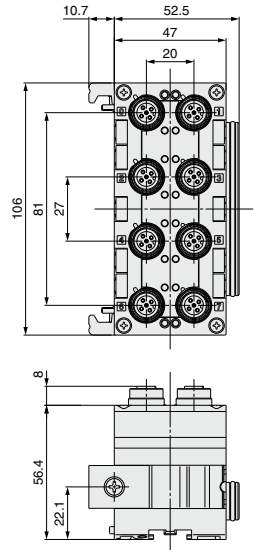

EX600-DX□E
EX600-DY□E
EX600-DM□E

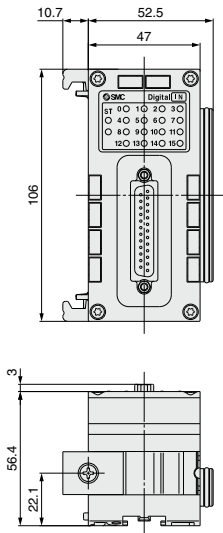

EX600-DX□F
EX600-DY□F
EX600-DM□F

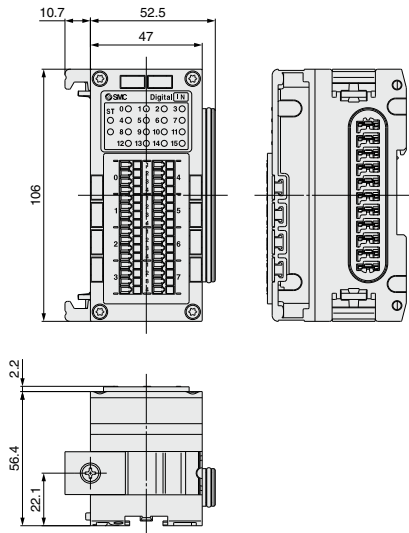

EX600 Series

Dimensions

Analog Unit

EX600-AXA
EX600-AYA

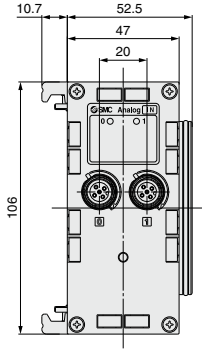

EX600-AMB

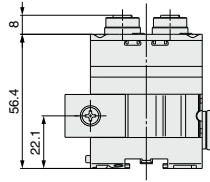
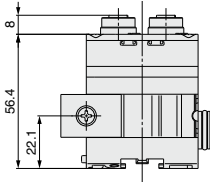
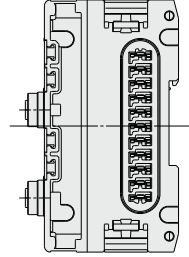
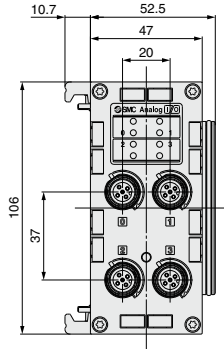

IO-Link Unit

EX600-LAB1
EX600-LBB1

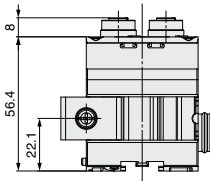
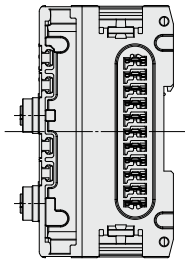
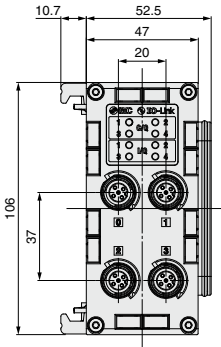

Parts Description

SI Unit

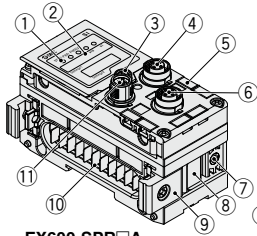

EX600-SPR□A
EX600-SMJ□
EX600-SDN□A

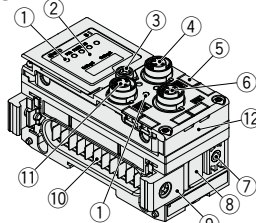

EX600-SEN3/4
EX600-SPN1/2

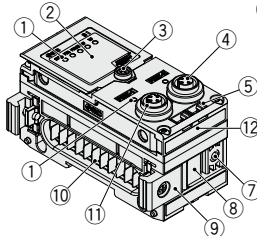

EX600-SEN7/8
EX600-SPN3/4
EX600-SEC3/4



No.	Name	Use
1	Status indication LED	Displays unit status
2	Indication cover	Open for setting the switch.
3	Indication cover set screw	Loosen for opening the indication cover.
4	Connector (BUS OUT)	Connects to the fieldbus output cable (SPEEDCON)*1
5	Marker groove	Can be used to mount a marker
6	Connector (PCI)	Connects to the handheld terminal cable (SPEEDCON)
7	Valve plate mounting holes	Fixes a valve plate in place
8	Valve plate mounting groove	Inserts a valve plate
9	Joint bracket	Links units to one another
10	Connector for unit (Plug)	Transmits signals to the neighboring unit and supplies power
11	Connector (BUS IN)	Connects to the cable for fieldbus input (SPEEDCON)*1
12	MAC address name plate	Displays a unique 12-digit MAC address for each SI unit
13	Seal cap	Mounted on the connectors (BUS OUT and PCI) at the time of shipment

*1 The EX600-SEN7/8, EX600-SPN3/4, and EX600-SEC3/4 are not SPEEDCON compatible.

Digital Unit

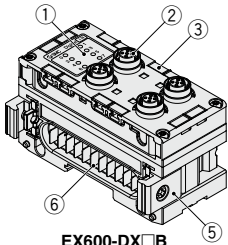

EX600-DX□B
EX600-DY□B

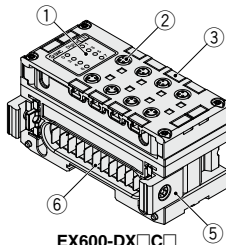

EX600-DX□C□

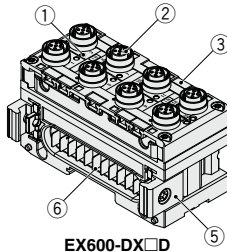

EX600-DX□D

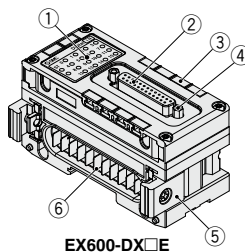

EX600-DX□E
EX600-DY□E
EX600-DM□E

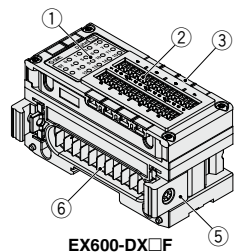

EX600-DX□F
EX600-DY□F
EX600-DM□F

No.	Name	Use
1	Status indication LED	Displays unit status
2	Connector	Connects with input or output devices (Only the EX600-D□□B and EX600-DX□D are SPEEDCON compatible.)
3	Marker groove	Can be used to mount a marker
4	Lock screw	Secures the D-sub connector in place (No.4-40 UNC)
5	Joint bracket	Links units to one another
6	Connector for unit (Plug)	Transmits signals to the neighboring unit and supplies power

EX600 Series

Parts Description

Analog Unit

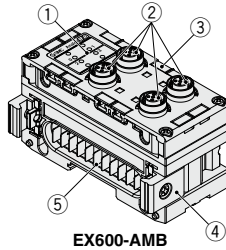
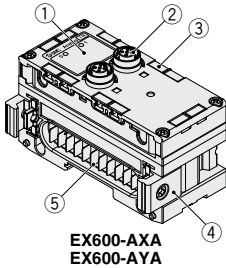

No.	Name	Use
1	Status indication LED	Displays unit status
2	Connector	Connects with input or output devices (SPEEDCON)
3	Marker groove	Can be used to mount a marker
4	Joint bracket	Links units to one another
5	Connector for unit (Plug)	Transmits signals to the neighboring unit and supplies power

IO-Link Unit

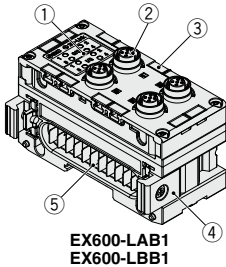

No.	Name	Use
1	Status indication LED	Displays unit status
2	Connector	Connects with IO-Link, input, or output devices (SPEEDCON)
3	Marker groove	Can be used to mount a marker
4	Joint bracket	Links units to one another
5	Connector for unit (Plug)	Transmits signals to the neighboring unit and supplies power

End Plate

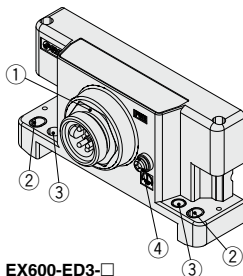
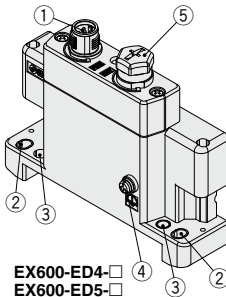
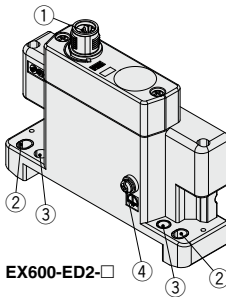

No.	Name	Use
1	Power connector (PWR IN)	Supplies power to the unit and/or input/output device (Only the EX600-ED2/ED4/ED5-□ is SPEEDCON compatible.)
2	Fixing hole for direct mounting	Connects directly to equipment
3	Fixing hole for DIN rail	Converts to manifold or for DIN rail mounting
4	FE terminal	Used for grounding Ground this terminal securely to improve noise immunity.
5	Connector (Unused) Power connector (PWR OUT)	Supplies power to the device on the downstream side

EX600-ED3-□

LED Indicator

EX600-SPR□□A

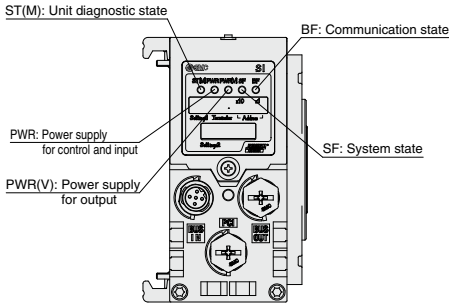

EX600-SDN□□A

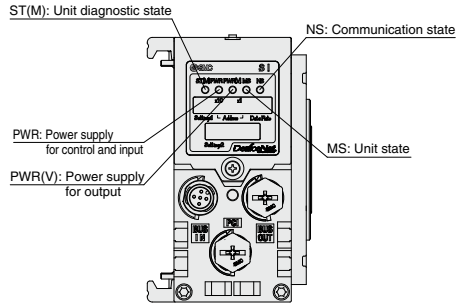

EX600-SEN3/SEN4

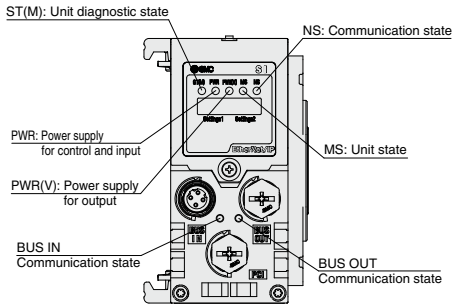

EX600-SEC□

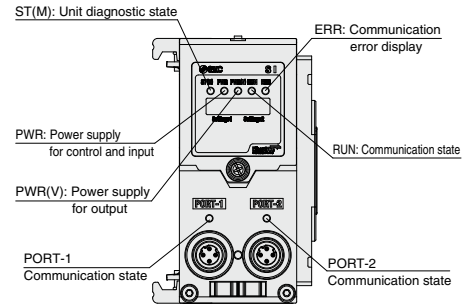

EX600-SEN7/SEN8

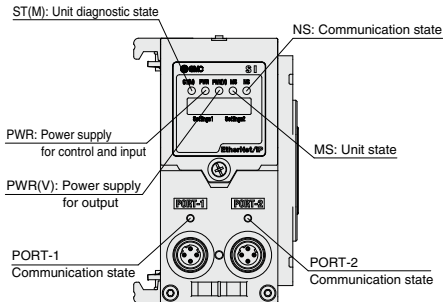

EX600-SPN1/SPN2

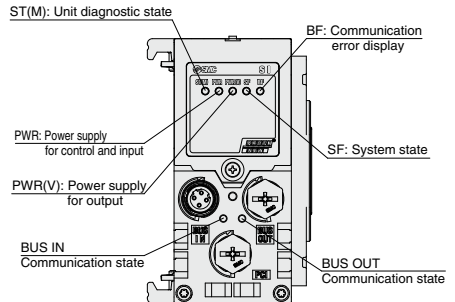

EX600 Series

LED Indicator

EX600-SPN3/SPN4

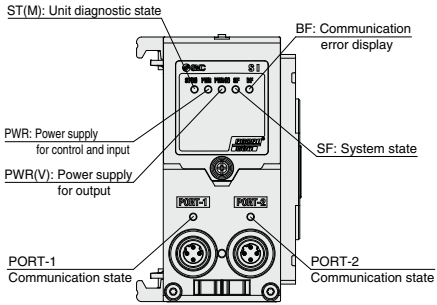

EX600-SMJ□

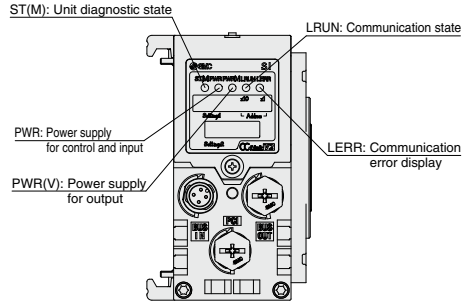

EX600-DX□B

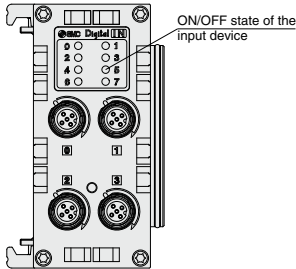

EX600-DX□C□

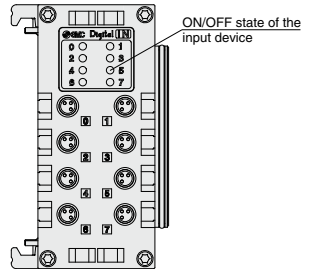

EX600-DX□D

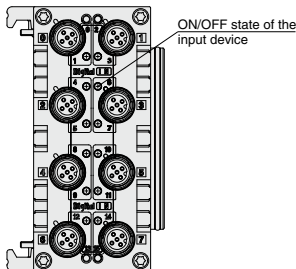

EX600-DX□E

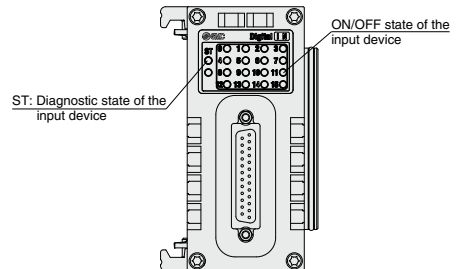

LED Indicator

EX600-DX□F

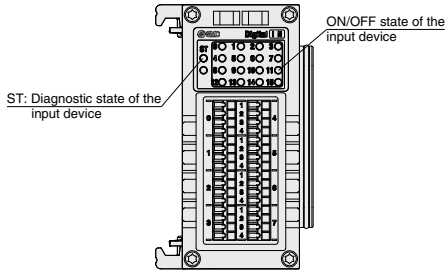

EX600-DY□B

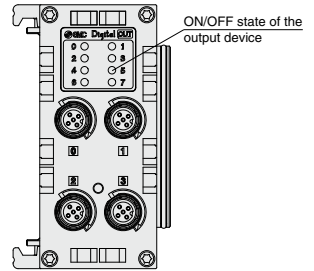

EX600-DY□E

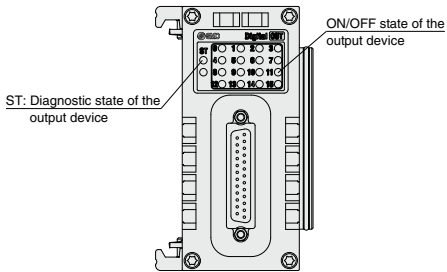

EX600-DY□F

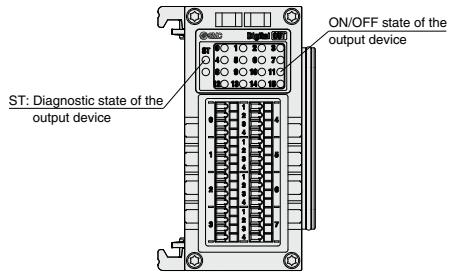

EX600-DM□E

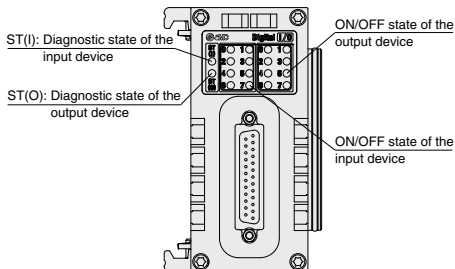

EX600-DM□F

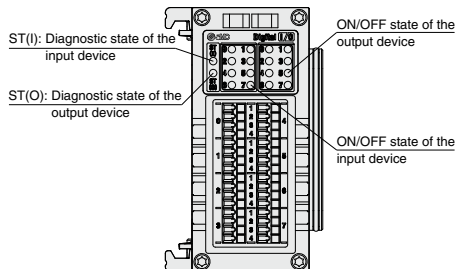

EX600 Series

LED Indicator

EX600-AXA

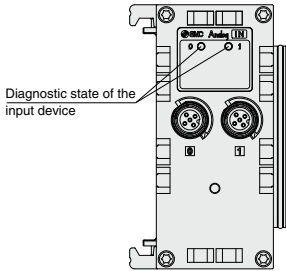

EX600-AYA

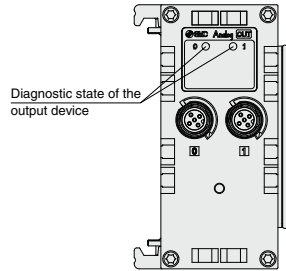

EX600-AMB

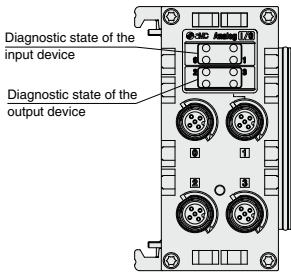

EX600-LAB1

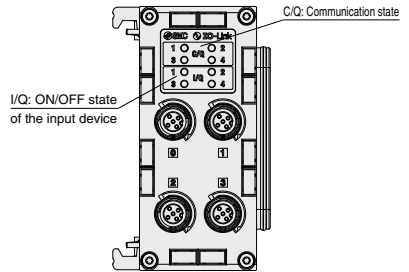

EX600-LBB1

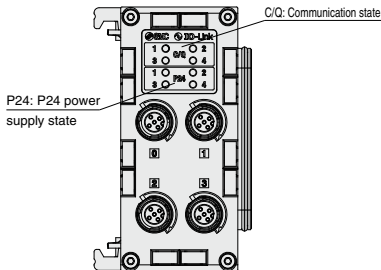

EX600 Series Accessories

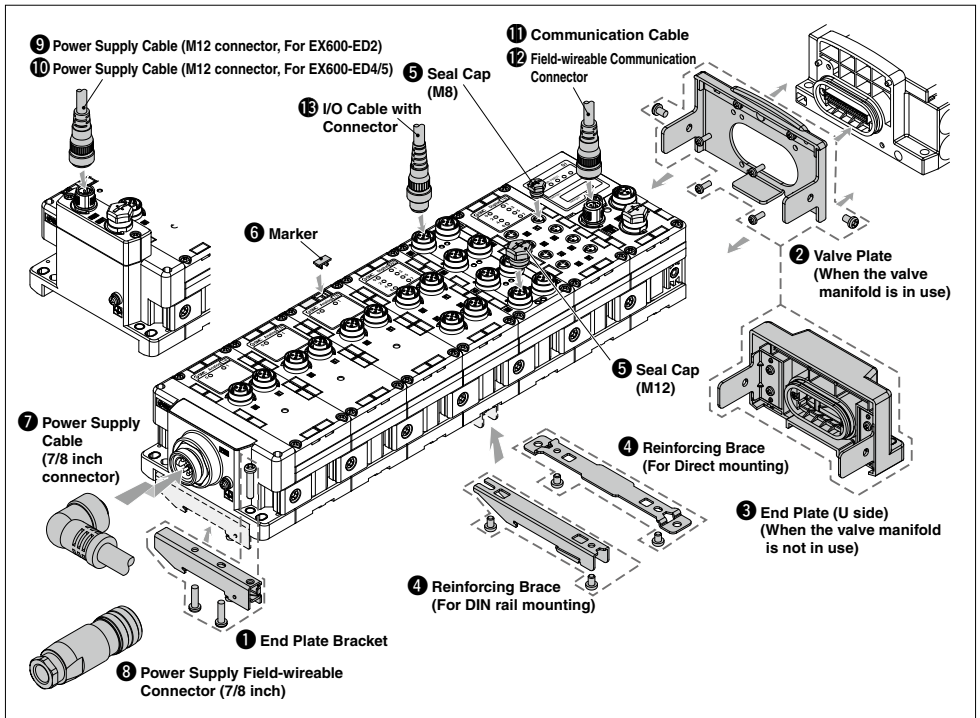

1 End Plate Bracket

This bracket is used for the end plate of DIN rail mounting.



EX600-ZMA2

Enclosed parts

Round head screw (M4 x 20) 1 pc.
P-tight screw (4 x 14) 2 pcs.

EX600-ZMA3

(Specialized for SY series)

Enclosed parts

Round head screw with washer (M4 x 20) 1 pc.
P-tight screw (4 x 14) 2 pcs.

2 Valve Plate

EX600-ZMV1

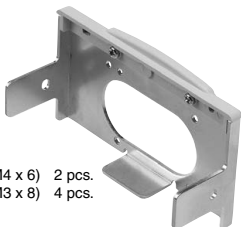

Enclosed parts

Round head screw (M4 x 6) 2 pcs.
Round head screw (M3 x 8) 4 pcs.

EX600-ZMV2

(Specialized for SY series)



Enclosed parts

Round head screw (M4 x 6) 2 pcs.
Round head screw (M3 x 8) 2 pcs.

EX600 Series

③ End Plate (U side)

The end plate is for use when the manifold valve is not connected.

EX600-E U 1 - **2**

● Mounting method

Symbol	Description	Note
Nil	Without DIN rail mounting bracket	—
2	With DIN rail mounting bracket	For EX600-ED□-2
3	With DIN rail mounting bracket	For EX600-ED□-3

* Select in accordance with the symbol for the end plate (D side) mounting method.

● Specification

Symbol	Specification
1	Waterproof cover

● End plate mounting position: U side

● End plate

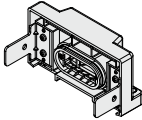

EX600-EU1

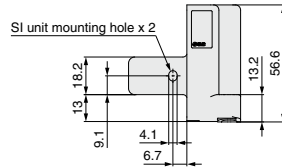
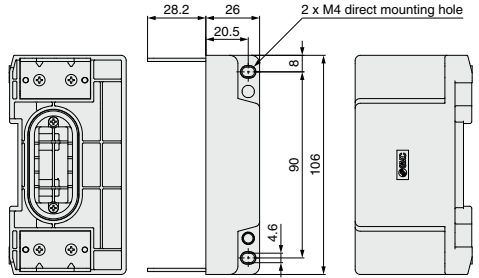

Enclosed parts

Round head screw (M4 x 5) 2 pcs.

④ Reinforcing Brace

This bracket is used on the bottom of the unit at the intermediate position for connecting 6 units or more.

* Be sure to attach this bracket to prevent connection failure between the units caused by deflection.

For Direct mounting
EX600-ZMB1



Enclosed parts

Round head screw (M4 x 5) 2 pcs.

For DIN rail mounting
EX600-ZMB2

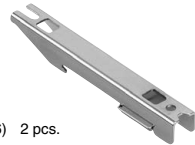

Enclosed parts

Round head screw (M4 x 6) 2 pcs.

⑤ Seal Cap (10 pcs.)

Be sure to mount a seal cap on any unused I/O connectors. Otherwise, the specified enclosure cannot be maintained.

EX9-AWES
For M8



EX9-AWTS
For M12



⑥ Marker (1 sheet, 88 pcs.)

The signal name of I/O device and each unit address can be entered and mounted on each unit.

EX600-ZT1

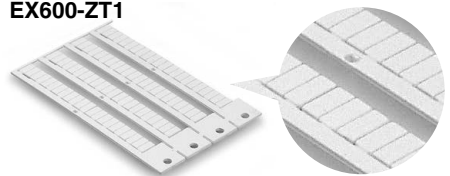

7 Power Supply Cable (7/8 inch connector)

- PCA-1558810 Straight 2 m
- PCA-1558823 Straight 6 m
- PCA-1558836 Right angled 2 m
- PCA-1558849 Right angled 6 m



Straight connector type

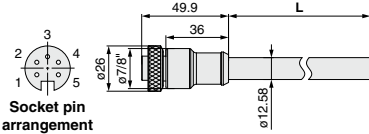

Socket pin arrangement

Angled connector type

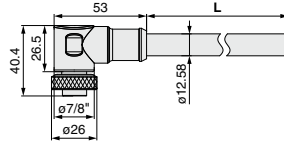

Socket pin arrangement

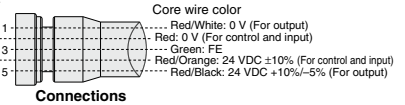
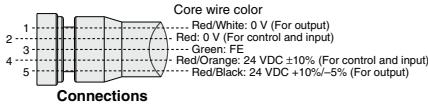

Item	Specifications
Cable O.D.	ø12.58 mm
Conductor nominal cross section	1.5 mm ² /AWG16
Wire O.D. (Including insulator)	2.35 mm
Min. bending radius (Fixed)	110 mm

8 Power Supply Field-wireable Connector (7/8 inch)

- PCA-1578081 Socket [compatible with AWG22-16]



Applicable Cable

Item	Specifications
Cable O.D.	ø12.0 to 14.0 mm
Wire gauge (Stranded wire cross section)	0.34 to 1.5 mm ² AWG22 to 16

9 Power Supply Cable (M12 connector, For EX600-ED2) * The shape of the M12 connector is B-coded (Reverse key).

- PCA-1564927 Straight 2 m
- PCA-1564930 Straight 6 m
- PCA-1564943 Right angled 2 m
- PCA-1564969 Right angled 6 m



SPEEDCON

Straight connector type

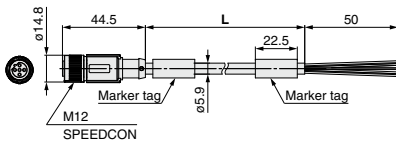

Angled connector type

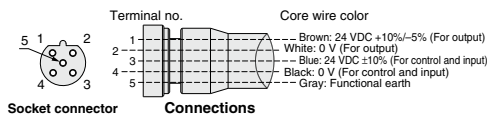
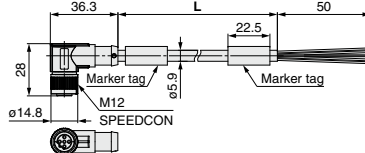

Socket connector pin arrangement B-coded (Reverse key)

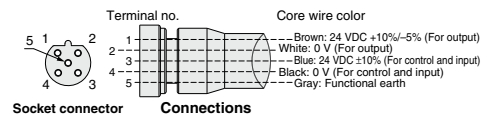

Socket connector pin arrangement B-coded (Reverse key)

Item	Specifications
Cable O.D.	ø5.9 mm
Conductor nominal cross section	0.34 mm ² /AWG22
Wire O.D. (Including insulator)	1.27 mm
Min. bending radius (Fixed)	59 mm

EX600 Series

⑩ Power Supply Cable (M12 connector, For EX600-ED4/5) * The shape of the M12 connector is A-coded (Normal key).

EX500-AP 050 - S

Cable length (L)

010	1000 mm
050	5000 mm

Connector specification

S	Straight
A	Angled



Straight connector type

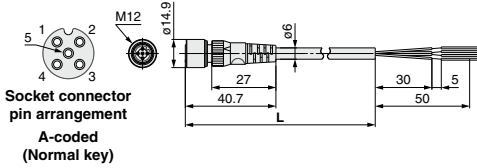

Item	Specifications
Cable O.D.	ø6 mm
Nominal cross section	0.3 mm ² /AWG22
Wire diameter (including insulator)	1.5 mm
Min. bending radius	40 mm (Fixed)

Angled connector type

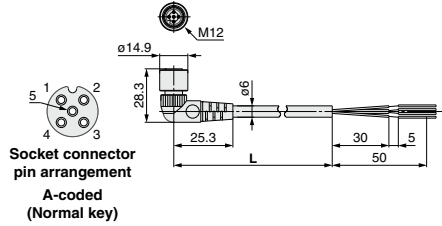

Item	Specifications
Cable O.D.	ø6 mm
Nominal cross section	0.3 mm ² /AWG22
Wire diameter (including insulator)	1.5 mm
Min. bending radius	40 mm (Fixed)

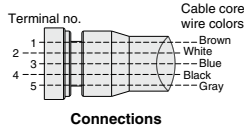

SPEEDCON

PCA-1401804

Cable length (L)

1401804	1500 mm
1401805	3000 mm
1401806	5000 mm

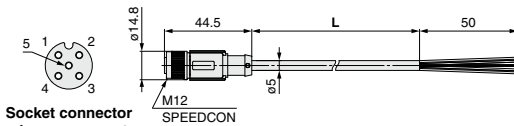

Item	Specifications
Cable O.D.	ø5 mm
Nominal cross section	0.3 mm ² /AWG22
Wire diameter (including insulator)	1.27 mm
Min. bending radius	21.7 mm (Fixed)

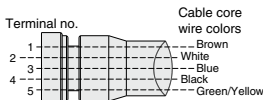

PCA-1557769

Cable length (L)

1557769	3000 mm
---------	---------

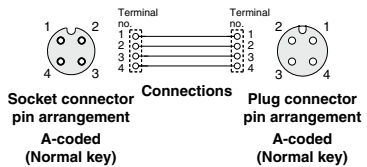
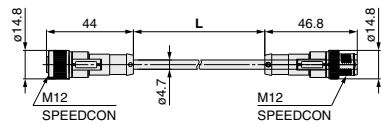

II Communication Cable

For CC-Link

PCA-1567720
(Socket)

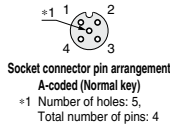

PCA-1567717
(Plug)

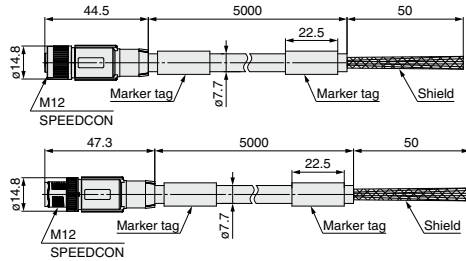
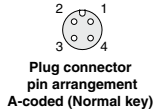

Made to Order

Cable length	10000 mm	p. 1439
--------------	----------	---------

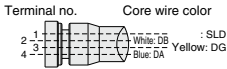

Connections

Item		Specifications
Cable O.D.		ø7.7 mm
Conductor nominal cross section	Data pair	0.5 mm ² /AWG20
	Drain	0.34 mm ² /AWG22
Wire O.D. (Including insulator)		2.55 mm
Min. bending radius (Fixed)		77 mm

EX9-AC 005 MJ-SSPS (With connector on both sides (Socket/Plug))

• Cable length (L)

005	500 mm
010	1000 mm
020	2000 mm
030	3000 mm
050	5000 mm
100	10000 mm

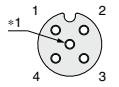
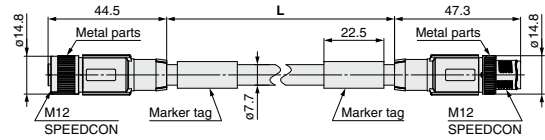

Socket connector pin arrangement
A-coded (Normal key)

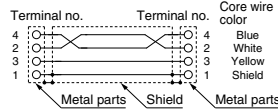

Connections

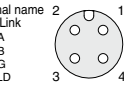

Plug connector pin arrangement
A-coded (Normal key)

Item		Specifications
Cable O.D.		ø7.7 mm
Conductor nominal cross section	Data pair	0.5 mm ² /AWG20
	Drain	0.34 mm ² /AWG22
Wire O.D. (Including insulator)		2.55 mm
Min. bending radius (Fixed)		77 mm

EX9-AC 005 MJ-SAPA (With angled connector on both sides (Socket/Plug))

• Cable length (L)

005	500 mm
010	1000 mm
020	2000 mm
030	3000 mm
050	5000 mm
100	10000 mm

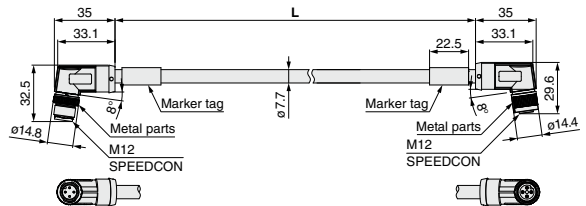

Plug connector pin arrangement
A-coded (Normal key)

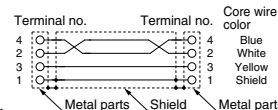

Connections

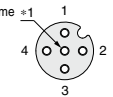

Socket connector pin arrangement
A-coded (Normal key)

Item		Specifications
Cable O.D.		ø7.7 mm
Conductor nominal cross section	Data pair	0.5 mm ² /AWG20
	Drain	0.34 mm ² /AWG22
Wire O.D. (Including insulator)		2.55 mm
Min. bending radius (Fixed)		77 mm

EX600 Series

Communication Cable

For DeviceNet®

PCA-1557633
(Socket)



Socket connector pin arrangement A-coded (Normal key)

PCA-1557646
(Plug)



Plug connector pin arrangement A-coded (Normal key)

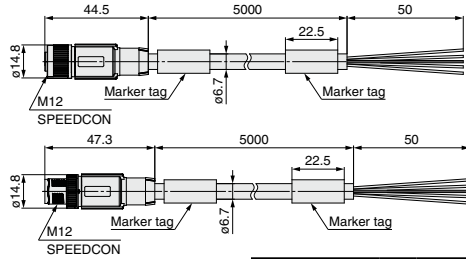

Item	Specifications
Cable O.D.	ø6.7 mm
Conductor nominal cross section	Power pair 0.34 mm ² /AWG22 Data pair 0.25 mm ² /AWG24
Wire O.D. (Including insulator)	Power pair 1.4 mm Data pair 1.95 mm
Min. bending radius (Fixed)	67 mm



Made to Order

Cable length	10000 mm	p. 1439
--------------	----------	---------

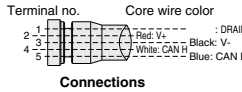

EX9-AC [005] DN-SSPS (With connector on both sides (Socket/Plug))

Cable length (L)

005	500 mm
010	1000 mm
020	2000 mm
030	3000 mm
050	5000 mm
100	10000 mm

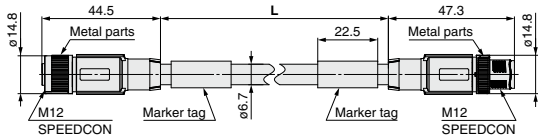

Item	Specifications
Cable O.D.	ø6.7 mm
Conductor nominal cross section	Power pair 0.34 mm ² /AWG22 Data pair 0.25 mm ² /AWG24
Wire O.D. (Including insulator)	Power pair 1.4 mm Data pair 1.95 mm
Min. bending radius (Fixed)	67 mm

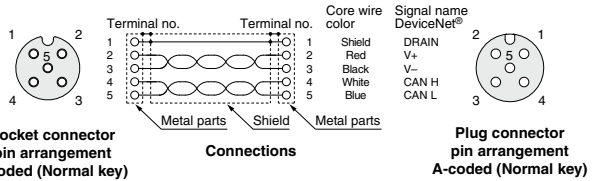

EX9-AC [005] DN-SAPA (With angled connector on both sides (Socket/Plug))

Cable length (L)

005	500 mm
010	1000 mm
020	2000 mm
030	3000 mm
050	5000 mm
100	10000 mm

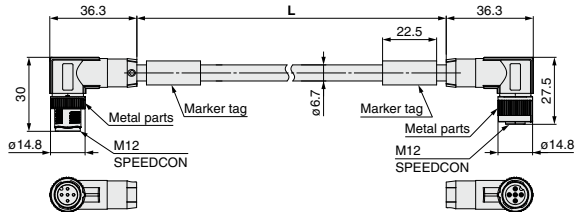

Item	Specifications
Cable O.D.	ø6.7 mm
Conductor nominal cross section	Power pair 0.34 mm ² /AWG22 Data pair 0.25 mm ² /AWG24
Wire O.D. (Including insulator)	Power pair 1.4 mm Data pair 1.95 mm
Min. bending radius (Fixed)	67 mm

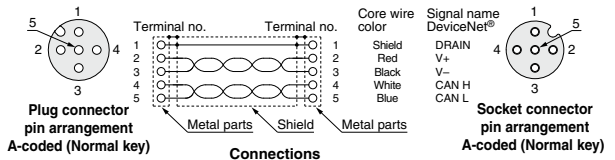

Communication Cable

For PROFIBUS DP

PCA-1557688
(Socket)

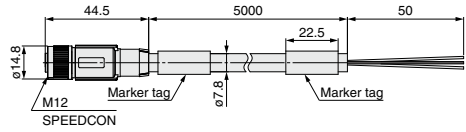
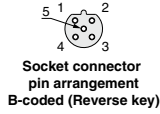

PCA-1557691
(Plug)

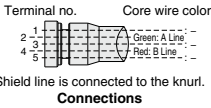
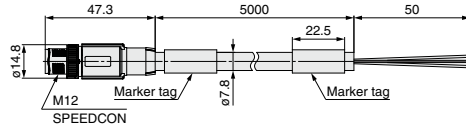
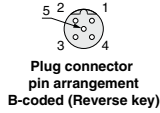

Item	Specifications
Cable O.D.	ø7.8 mm
Conductor nominal cross section	0.34 mm ² /AWG22
Wire O.D. (Including insulator)	2.55 mm
Min. bending radius (Fixed)	78 mm

For EtherCAT® For PROFINET For EtherNet/IP™

EX9-AC 020 EN-PSRJ (Plug/RJ-45 connector)

• Cable length (L)

010	1000 mm
020	2000 mm
030	3000 mm
050	5000 mm
100	10000 mm

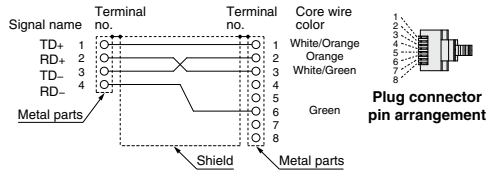
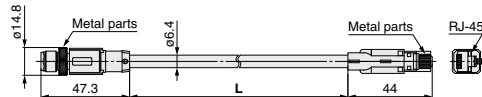
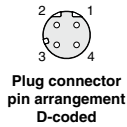

Item	Specifications
Cable O.D.	ø6.4 mm
Conductor nominal cross section	0.14 mm ² /AWG26
Wire O.D. (Including insulator)	0.98 mm
Min. bending radius (Fixed)	26 mm

PCA-1446566 (Plug)

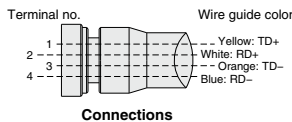
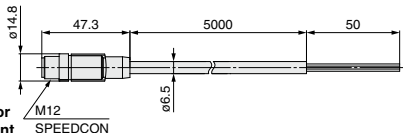
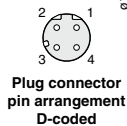

Item	Specifications
Cable O.D.	ø6.5 mm
Conductor nominal cross section	AWG22
Wire O.D. (Including insulator)	1.55 mm
Min. bending radius (Fixed)	45.5 mm

EX600 Series

Communication Cable

For EtherCAT®

For PROFINET

For EtherNet/IP™

EX9-AC 005 EN-PSPS (With connector on both sides (Plug/Plug))

Cable length (L)

005	500 mm
010	1000 mm
020	2000 mm
030	3000 mm
050	5000 mm
100	10000 mm



Plug connector pin arrangement D-coded

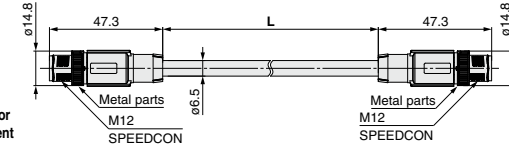

Plug connector pin arrangement D-coded

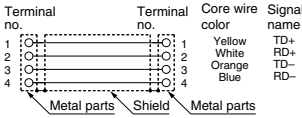

Connections (Straight cable)

Item	Specifications
Cable O.D.	ø6.5 mm
Conductor nominal cross section	0.34 mm ² /AWG22
Wire O.D. (Including insulator)	1.55 mm
Min. bending radius (Fixed)	19.5 mm

EX9-AC 005 EN-PAPA (With angled connector on both sides (Plug/Plug))

Cable length (L)

005	500 mm
010	1000 mm
020	2000 mm
030	3000 mm
050	5000 mm
100	10000 mm



Plug connector pin arrangement D-coded

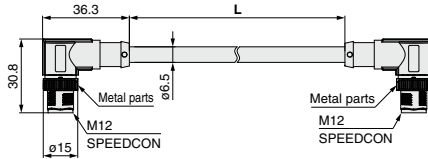

Plug connector pin arrangement D-coded

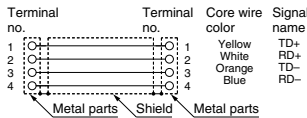

Connections (Straight cable)

Item	Specifications
Cable O.D.	ø6.5 mm
Conductor nominal cross section	0.34 mm ² /AWG22
Wire O.D. (Including insulator)	1.55 mm
Min. bending radius (Fixed)	19.5 mm

12 Field-wireable Communication Connector

Plug

For CC-Link **For DeviceNet®**
PCA-1075526 **PCA-1075528**

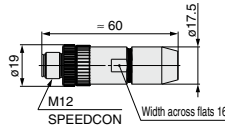

Applicable Cable

Item	Specifications
Cable O.D.	4.0 to 8.0 mm
Wire gauge (Stranded wire cross section)	0.14 to 0.75 mm ² /AWG26 to 18 (Solid cable/Flexible cable) 0.08 to 0.5 mm ² /AWG28 to 20 (With ferrule)

For PROFIBUS DP
PCA-1075530

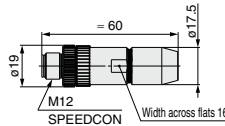

For EtherCAT® **For PROFINET** **For EtherNet/IP™**
PCA-1446553

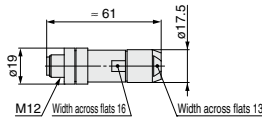

Applicable Cable

Item	Specifications
Cable O.D.	4.0 to 8.0 mm
Wire gauge (Stranded wire cross section)	0.14 to 0.34 mm ² /AWG26 to 22

* The table above shows the specifications for the applicable cable. Adaptation for the connector may vary on account of the conductor construction of the electric wire.

Socket

For CC-Link **For DeviceNet®**
PCA-1075527 **PCA-1075529**

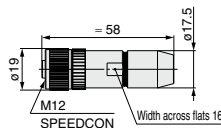

Applicable Cable

Item	Specifications
Cable O.D.	4.0 to 8.0 mm
Wire gauge (Stranded wire cross section)	0.14 to 0.75 mm ² /AWG26 to 18 (Solid cable/Flexible cable) 0.08 to 0.5 mm ² /AWG28 to 20 (With ferrule)

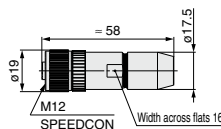

For PROFIBUS DP
PCA-1075531



EX600 Series

I/O Cable with Connector, I/O Connector

For details, refer to the **Web Catalog**.

Name	Use	Part no.	Description
Cable with connector		PCA-1557769	Cable with M12 connector (4 pins/3 m)
		PCA-1557772	Cable with M8 connector (3 pins/3 m)
Field-wireable connector		PCA-1557730	Field-wireable connector (M8/3 pins/Plug/Piercecon® connection)
		PCA-1557743	Field-wireable connector (M12/4 pins/Plug/QUICKON-ONE connection/SPEEDCON)
		PCA-1557756	Field-wireable connector (M12/4 pins/Plug/QUICKON-ONE connection/SPEEDCON)
Y connector		PCA-1557785	Y connector (2 x M12 (5 pins)-M12 (5 pins)/SPEEDCON)
		PCA-1557798	Y connector (2 x M8 (3 pins)-M12 (4 pins)/SPEEDCON)

* When using the Y connector, connect it to the connector on the I/O unit through the sensor cable (PCA-1557769) with the M12 connector.

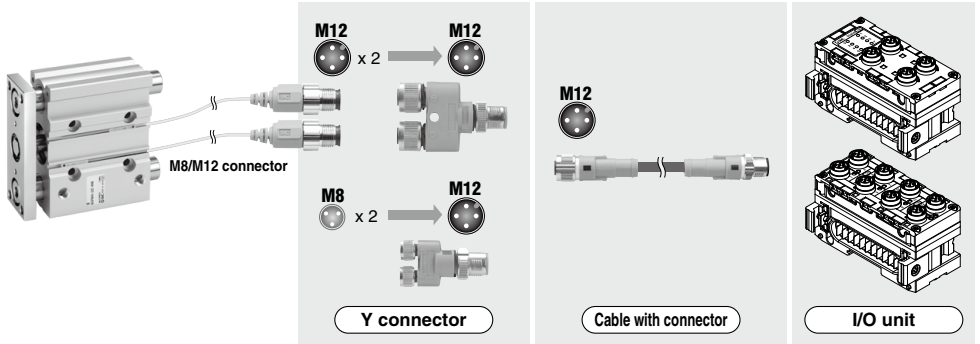

For IO-Link Unit

EX9-AC [005] -SSPS (With connector on both sides (Socket/Plug))

Cable length (L)

005	500 mm
010	1000 mm
020	2000 mm
030	3000 mm
050	5000 mm
100	10000 mm

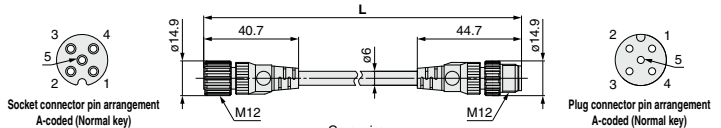

Terminal no.



Connections

Terminal no.	Core wire color
1	Brown
2	White
3	Blue
4	Black
5	Gray

Item	Specifications
Cable O.D.	$\phi 6$ mm
Conductor nominal cross section	0.3 mm ² /AWG22
Wire O.D. (including conductor)	1.5 mm
Min. bending radius (Fixed)	40 mm

13 I/O Cable with Connector, I/O Connector

Port Class B EX260-SIL SI Unit and Port Class A IO-Link Master Connection Example

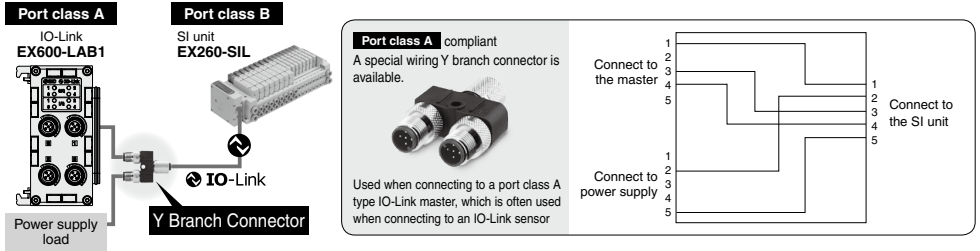

Y Branch Connector for IO-Link

This connector is used to supply power to the valve manifold by branching the IO-Link communication cable in cases where a port class A IO-Link master is used.

EX9-ACY02-S

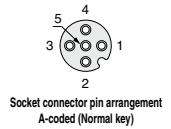
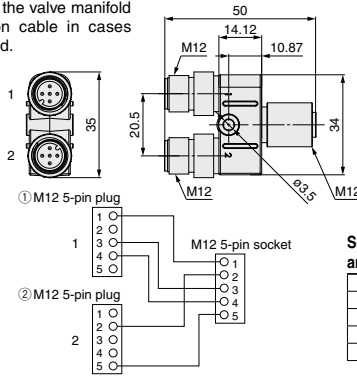
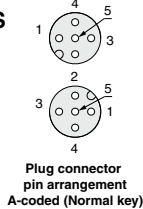

Solenoid valve power supply cable side pin arrangement when using a branch connector

1	—	Unused
2	SV24V	+24 V for solenoid valve
3	—	Unused
4	—	Unused
5	SV0V	0 V for solenoid valve

14 IO-Link Device Tool License Key

USB dongle
EX9-ZSW-LDT1

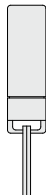
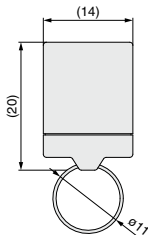

* The IO-Link Device Tool V5-PE (V5 or later only) manufactured by TMG is required for setting IO-Link devices.
The IO-Link Device Tool can be downloaded for free from TMG's website. However, to use it for more than 30 days, a license key for the IO-Link Device Tool is required.

EX600 Series

Made to Order

Please contact SMC for detailed specifications and lead times.



SI Unit

Prepare the SI unit, each type of unit, and the manifold valve (without SI unit) separately, and combine them before use.

① Ethernet POWERLINK compatible

EX600-SPL1-X26

• Dimensions are the same as those of the EX600-SEN3.

② Modbus/TCP compatible

EX600-SMT1-X25

• Dimensions are the same as those of the EX600-SEN3.

③ CC-Link IE Field compatible

EX600-SCF 1 -X60

• Output polarity

1	PNP
2	NPN

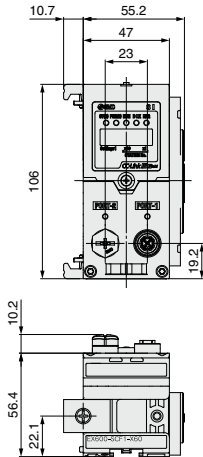

EX600-SCF -X60 Wiring Specifications

Communication connector PORT 1 & PORT 2

M12 8-pin socket, X-Coding (Cat.6A)



No.	Designation
1	DA+
2	DA-
3	DB+
4	DB-
5	DD+
6	DD-
7	DC-
8	DC+

Communication cable examples

[M12 connector — RJ45 connector]
(made by PHOENIX CONTACT)

NBC-MSX/1,0-94F/R4AC SCO (Order No.1407471)(1 m)
NBC-MSX/2,0-94F/R4AC SCO (Order No.1407472)(2 m)
NBC-MSX/5,0-94F/R4AC SCO (Order No.1407473)(5 m)

(made by Mitsubishi Electric System & Service Co., Ltd.)
SC-E5EW-SX ^{#1}M (For indoor use)

SC-E5EW-SX ^{#2}M-MV (For indoor moving parts)

*1 The specified length (cable length) goes into the . Units of 1 to 100 m/1 m

*2 The specified length (cable length) goes into the . Units of 1 to 45 m/1 m

[M12 connector — M12 connector]

(made by PHOENIX CONTACT)

NBC-MSX/1,0-94F/MSX SCO (Order No.1407483)(1 m)

NBC-MSX/2,0-94F/MSX SCO (Order No.1407484)(2 m)

NBC-MSX/5,0-94F/MSX SCO (Order No.1407485)(5 m)

(made by Mitsubishi Electric System & Service Co., Ltd.)

SC-E5EW-SX ^{#1}M (For indoor use)

SC-E5EW-SX ^{#2}M-MV (For indoor moving parts)

*1 The specified length (cable length) goes into the . Units of 1 to 100 m/1 m

*2 The specified length (cable length) goes into the . Units of 1 to 45 m/1 m

⚠ Caution

Communication cables need to be ordered directly from each company.

Communication Cable

With connector on one side (Socket)

Cable length: 10000 mm

For CC-Link For DeviceNet®

EX9-AC100 MJ-X12

• Applicable protocol

MJ	CC-Link
DN	DeviceNet®

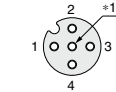

Socket connector pin arrangement A-coded (Normal key)

For CC-Link

Dimensions

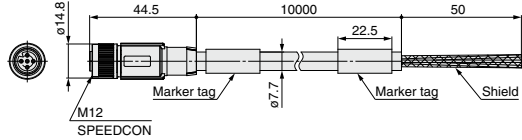

Connections

Terminal no.	Core wire color: Signal name (CC-Link)
1	Shield: SLD
2	White: DB
3	Yellow: DG
4	Blue: DA

*1 Number of holes: 5, Total number of pins: 4

Item	Specifications
Cable O.D.	ø7.7 mm
Conductor nominal cross section	Data pair 0.5 mm ² /AWG20
	Drain 0.34 mm ² /AWG22
Wire O.D. (including insulator)	2.55 mm
Min. bending radius (Fixed)	77 mm

For DeviceNet®

Dimensions

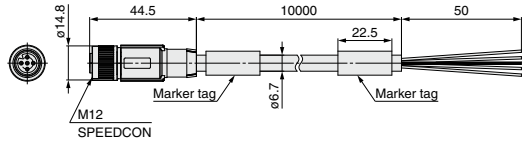

Connections

Terminal no.	Core wire color: Signal name (DeviceNet®)
1	Shield: DRAIN
2	Red: V+
3	Black: V-
4	White: CAN H
5	Blue: CAN L

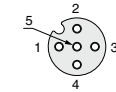

Socket connector pin arrangement A-coded (Normal key)

Item	Specifications
Cable O.D.	ø6.7 mm
Conductor nominal cross section	Power pair 0.34 mm ² /AWG22
	Data pair 0.25 mm ² /AWG24
Wire O.D. (including insulator)	Power pair 1.4 mm
	Data pair 2.05 mm
Min. bending radius (Fixed)	67 mm



EX600 Series

Specific Product Precautions

Be sure to read this before handling the products. Refer to page 7 for safety instructions and pages 15 to 17 for fieldbus system precautions.

Mounting

⚠ Caution

1. When handling and assembling units, do not touch the sharp metal parts of the connector or plug.
2. When connecting six stations or more, be sure to use the intermediate reinforcing brace (EX600-ZMB1 or EX600-ZMB2).

Operating Environment

⚠ Caution

1. Select the proper type of enclosure according to the operating environment.

IP65/67 is achieved when the following conditions are met.

- 1) Provide appropriate wiring between all units using electrical wiring cables, communication connectors and cables with M12 connectors.
- 2) Appropriately mount each unit and valve manifold.
- 3) Be sure to mount a seal cap on any unused connectors.

If using in an environment that is exposed to water splashes, please take measures such as using a cover. When the enclosure is IP40, do not use in an operating environment or atmosphere where it may come in contact with corrosive gas, chemical agents, seawater, water, or water vapor. When connected to the EX600-D□□E or EX600-D□□F, manifold enclosure is IP40.

Also, the handheld terminal conforms to IP20, so prevent foreign matter from entering inside, and water, solvent or oil from coming in direct contact with it.

Adjustment / Operation

⚠ Warning

<Handheld Terminal>

1. Do not apply pressure to the LCD.
There is a possibility of the crack of LCD and injuring.
2. The forced input/output function is used to change the signal status forcibly. When operating this function, be sure to check the safety of the surroundings and installation.
This may cause injuries or equipment damage.
3. Incorrect setting of parameters can cause a malfunction. Be sure to check the settings before use.
This may cause injuries or equipment damage.

⚠ Caution

<Handheld Terminal>

1. Do not press the setting buttons with a sharp pointed object.
This may cause damage or equipment failure.
2. Do not apply excessive load and impact to the setting buttons.
This may cause damage, equipment failure or malfunction.

When the order does not include the SI unit, a valve plate which connects the manifold and SI unit, is not mounted. Use attached valve holding screws and mount the valve plate.
(Tightening torque: 0.6 to 0.7 N·m)

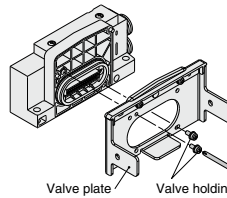

- Screw tightened parts
- SV series: 2 places
 - S0700 series: 2 places
 - VQC1000 series: 2 places
 - VQC2000 series: 3 places
 - VQC4000 series: 4 places
 - VQC5000 series: 4 places
 - SY series: 2 places
 - JSY series: 2 places
 - ZK2□A series: 2 places

■ Trademark

DeviceNet® is a registered trademark of ODVA, Inc.
 EtherNet/IP® is a registered trademark of ODVA, Inc.
 EtherCAT® is registered trademark and patented technology, licensed by Beckhoff Automation GmbH, Germany.
 Modbus® is a registered trademark of Schneider Electric, licensed to the Modbus Organization, Inc.
 QuickConnect™ is a trademark of ODVA.