

Type 3 Integrated input-output type

Fieldbus System (For Input/Output)

EX250 Series

Compatible Protocols

DeviceNet  EtherNet/IP

Made to Order  Modbus CC-Link IE  Field



- ★ Enclosure IP67
- ★ Maximum 32 inputs/32 outputs
- ★ Sensors with M8/M12 connectors can be connected.

Manifold Solenoid Valves

SY3000/5000/7000

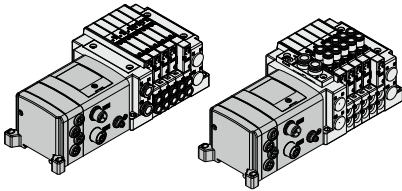

VQC1000/2000/4000/5000

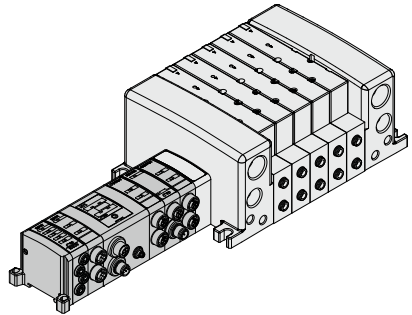

S0700

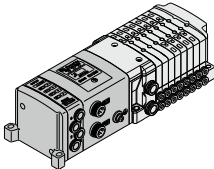

SV1000/2000/3000

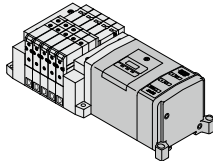

CONTENTS

Type 3 Integrated input-output type

Fieldbus System (For Input/Output)

EX250 Series

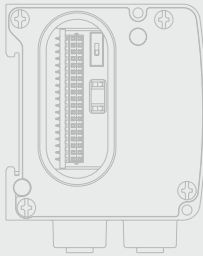
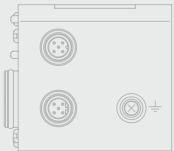
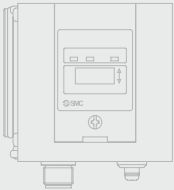

Parts Structure	p. 1343
SI Unit	

How to Order	p. 1343
Specifications	p. 1344
Dimensions/Parts Description	p. 1345
LED Indicator	p. 1347

Input Block

How to Order	p. 1348
Specifications	p. 1348
Dimensions/Parts Description	p. 1349
LED Indicator	p. 1350
Internal Circuit	p. 1350

Accessories

Example of Connections	p. 1351
① Replacement Fuse	p. 1352
② End Plate (Input side)	p. 1352
③ Output Block	p. 1353
④ Power Block	p. 1353
⑤ End Plate (Output side)	p. 1356
⑥ Communication Cable	p. 1357
⑦ Field-wireable Communication Connector	p. 1359
⑧ Power Supply Cable (For SI unit/For power block) ..	p. 1359
⑧ Power Supply Cable (For SI unit)	p. 1360
⑨ Cable for Output Entry	p. 1360
⑩ Seal Cap (10 pcs.)	p. 1360
⑪ Power Supply Cable (For connecting the SI unit to the power block) ..	p. 1361
⑫ AS-Interface Power Supply Cable	p. 1361

Made to Order

① DeviceNet®, 7/8 inch connector, Occupied points: 48 inputs/32 outputs	p. 1362
Communication Cable	p. 1362
Power Supply Cable	p. 1363

Specific Product Precautions	p. 1364
------------------------------------	---------

Fieldbus System For Input/Output

EX250 Series



Parts Structure

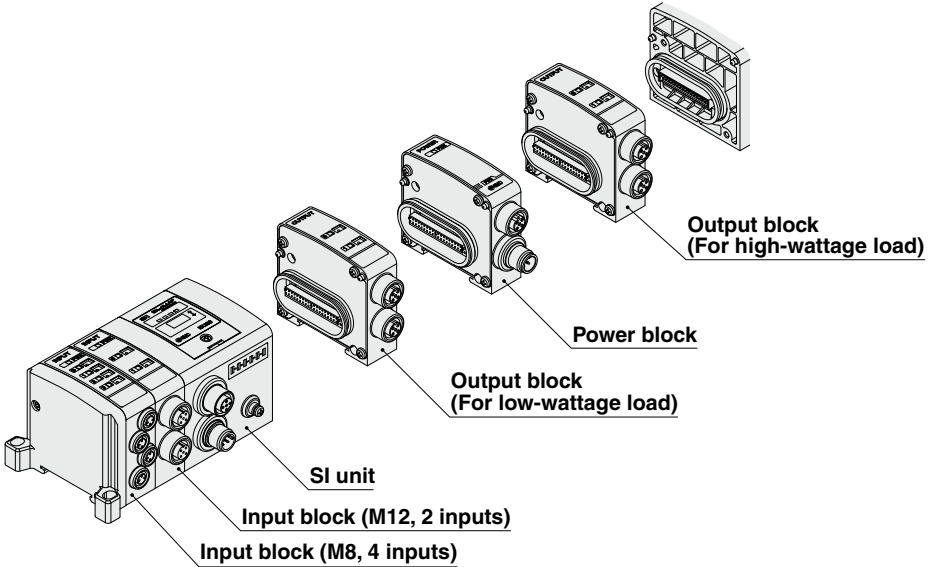

SI Unit

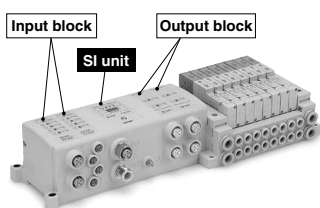
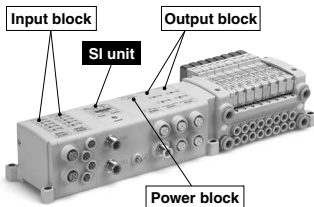

How to Order

EX250-S **DN1** -

• Made to Order → p. 1362
DeviceNet® 7/8 inch connector

• Protocol

DN1*1	DeviceNet®
DN1-X102*1	DeviceNet®
AS3	AS-Interface (8in/8out, 2 power supply systems)
AS5	AS-Interface (4in/4out, 2 power supply systems)
AS7	AS-Interface (8in/8out, 1 power supply system)
AS9	AS-Interface (4in/4out, 1 power supply system)
EN1	EtherNet/IP™

*1 DN1's occupied points are 32 inputs and 32 outputs, while DN1-X102 has 48 inputs and 32 outputs.

EX250 Series

Specifications

Model			EX250-SDN1	EX250-SDN1-X102 ^{*1}	EX250-SEN1	EX250-SAS3/5	EX250-SAS7/9
Communication	Applicable system	Protocol	DeviceNet®		EtherNet/IP™	AS-Interface	
		Version ^{*2}	Release 2.0		Release 1.0	Ver. 2.11 (Standard Address Mode)	
	Communication speed		125 k/250 k/500 kbps		10 M/100 Mbps	167 kbps	
	Configuration file ^{*3}		EDS file		EDS file	—	—
	I/O occupation area (Inputs/Outputs)		32/32	48/32	48/32	SAS3: 8/8 (2 nodes occupied) SAS5: 4/4	SAS7: 8/8 (2 nodes occupied) SAS9: 4/4
	Applicable function		QuickConnect™		—	—	—
Terminating resistor		Not provided		Not provided (Not required)			
Power supply voltage	For control		11 to 25 VDC (Supplied by DeviceNet® circuit)		24 VDC ±20%	26.5 to 31.6 VDC (Supplied by AS-i circuit)	*4 26.5 to 31.6 VDC (Supplied by AS-i circuit)
	For sensors		24 VDC ±20%				
	For valve		24 VDC +10%/-5%				
Internal current consumption (Unit)			100 mA or less			SAS3: 100 mA or less SAS5: 65 mA or less	SAS7: 100 mA or less SAS9: 65 mA or less
Input	Number of inputs		32 inputs (Based on input block connection)			SAS3: 8 inputs SAS5: 4 inputs	SAS7: 8 inputs SAS9: 4 inputs
	Supply voltage		24 VDC				
	Supply current		1.0 A or less			SAS3: 240 mA or less SAS5: 120 mA or less	*5
Output	Output type		Source/PNP (Negative common)				
	Number of outputs		32 outputs			SAS3: 8 outputs SAS5: 4 outputs	SAS7: 8 outputs SAS9: 4 outputs
	Load		Solenoid valve with surge voltage suppressor 24 VDC, 1.5 W or less (SMC) Output block Power block				
	Supply voltage		24 VDC				
	Supply current		2.0 A or less			SAS3: 500 mA or less SAS5: 250 mA or less	*5
	Fail safe		HOLD/CLEAR (Switch setting)				
Environmental resistance	Enclosure		IP67				
	Operating temperature range		5 to +45°C				
	Operating humidity range		35 to 85%RH (No condensation)				
	Withstand voltage		500 VAC for 1 minute between whole external terminal and FG				
	Insulation resistance		10 MΩ or more (500 VDC) between whole external terminal and FG				
Standards			CE/UKCA marking, UL (CSA)				
Weight			250 g				
Accessory ^{*6}			Tie-rod 2 pcs.				

*1 This is a specification to transmit the diagnostic information of voltage drop of the valve power supply and input block fuse blowout as an input data to the master. The EX250-SDN1 becomes I/O connection time out when the diagnostic information is detected, but not EX250-SDN1-X102.

Since this is a special product, a manifold part number is not specified. Please consult SMC for the manifold integrated type.

*2 Please note that the version is subject to change.

*3 The setting file can be downloaded from SMC website, <https://www.smcworld.com>

*4 Since the EX250-SAS7/9 is compatible with the 1 power supply system, the power supply for units is divided into two: the power supply for sensors and for valves.

*5 Since the EX250-SAS7/9 is compatible with the 1 power supply system, the power supply must be divided in accordance with the values below. (Refer to page 1364 for details.)

EX250-SAS7 ... Max. 240 mA, EX250-SAS9 ... Max. 120 mA

*6 When the SI unit is mounted to the manifold when shipped, accessories are shipped together with it.

*7 For detailed specifications other than the above, refer to the operation manual that can be downloaded from SMC website, <https://www.smcworld.com>

Dimensions/Parts Description

EX250-SDN1 (DeviceNet[®])

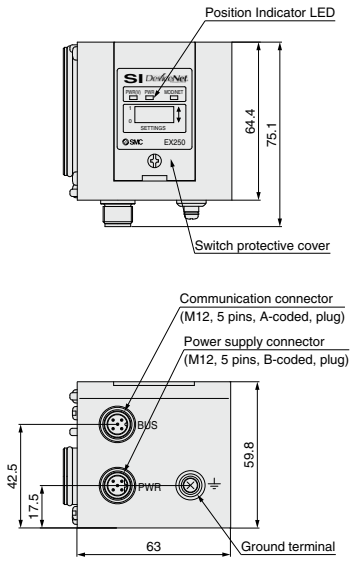

EX250 Series

Dimensions/Parts Description

EX250-SEN1 (EtherNet/IP™)

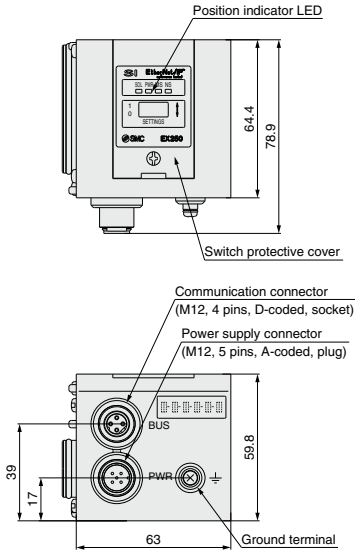

EX250-SAS7/9 (AS-Interface 1 power supply system)

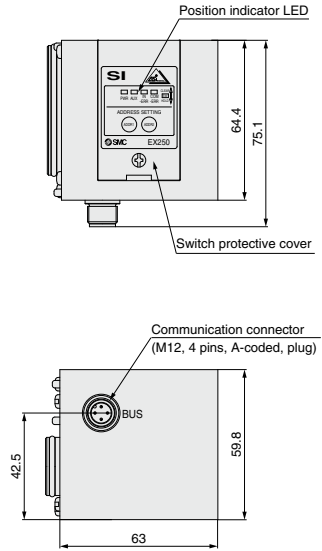

EX250-SAS3/5 (AS-Interface 2 power supply systems)

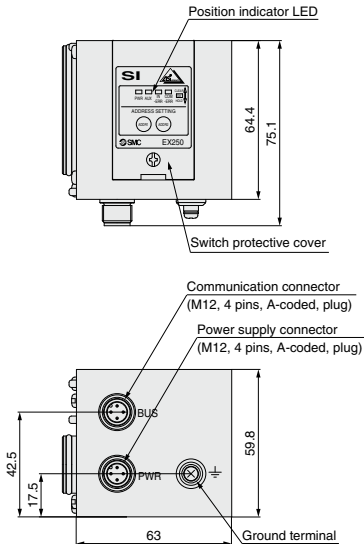

LED Indicator

EX250-SDN1 (DeviceNet®)

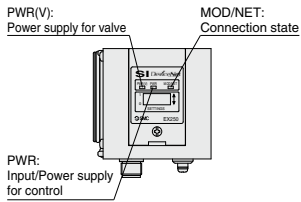

EX250-SEN1 (EtherNet/IP™)

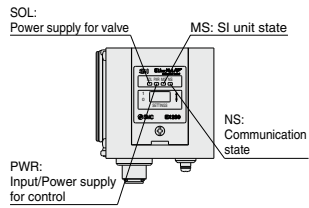

EX250-SAS7/9 (AS-Interface 1 power supply system)

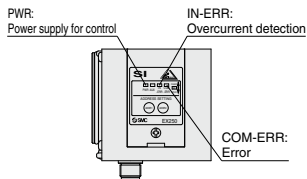

EX250-SAS3/5 (AS-Interface 2 power supply systems)

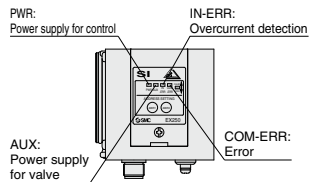

EX250 Series

How to Order

Input Block

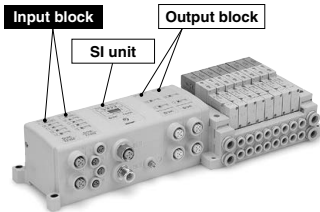
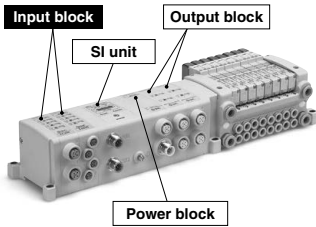

EX250-IE 1

Block type

1	M12 connector, 2 inputs
2	M12 connector, 4 inputs
3	M8 connector, 4 inputs

For accessory, refer to pages 1351 to 1361.

Specifications

Model		EX250-IE1	EX250-IE2	EX250-IE3
Input	Input type	PNP/NPN sensor input (switched using a switch)		
	Number of inputs	2 inputs	4 inputs	
	Input device supply voltage	24 VDC		
	Input device supply current	Max. 30 mA/Point*1		
	Rated input current	Approx. 8 mA		
Environmental resistance	Enclosure	IP67		
	Operating temperature range	-10 to +50°C		
	Operating humidity range	35 to 85%RH (No condensation)		
	Withstand voltage	500 VAC for 1 minute between whole external terminal and FG		
Standards	Insulation resistance	10 MΩ or more (500 VDC) between whole external terminal and FG		
	Standards	CE/UKCA marking, UL (CSA)		
Weight		90 g		
Accessory*2		Tie-rod 2 pcs.		

*1 When the maximum inputs to the SI unit is reached by adding an input block, pay attention not to exceed the supply current for the SI unit input.

*2 When the SI unit is integrated into manifold, its tie-rod is also incorporated at the time of shipment.

* For detailed specifications other than the above, refer to the operation manual that can be downloaded from SMC website, <https://www.smworld.com>

Dimensions/Parts Description

EX250-IE1, EX250-IE2

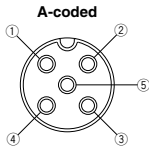
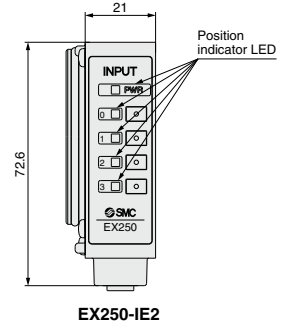
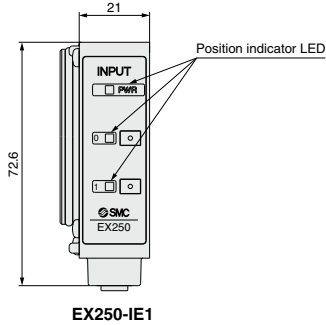
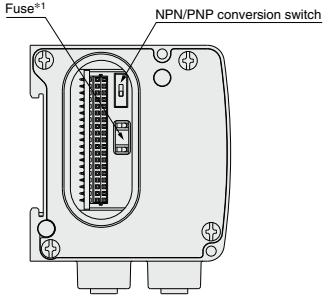

Socket pin arrangement

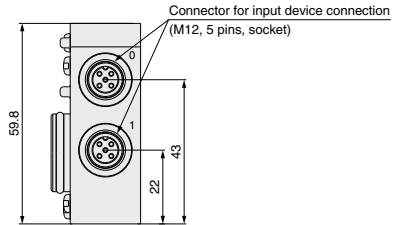

EX250-IE3

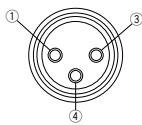
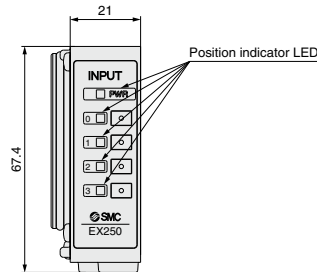
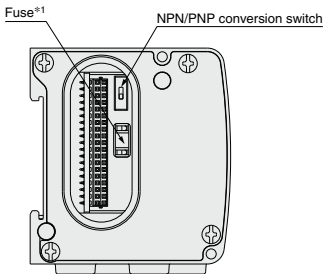

Socket pin arrangement

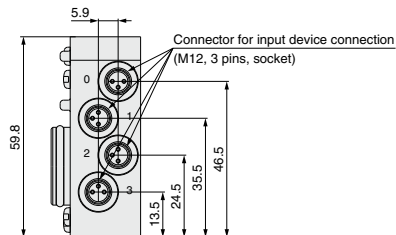

*1 Fuse for overcurrent protection

If addressing the possible cause of a problem, even when the fuse is blown, it can be reinstated by replacing with a fuse as shown in options, page 1352

EX250 Series

LED Indicator

EX250-IE1

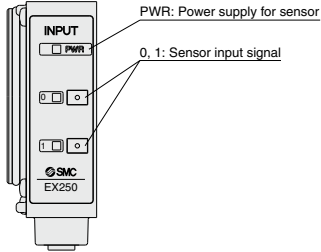

EX250-IE2

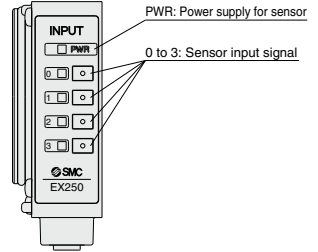

EX250-IE3

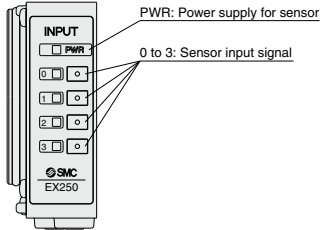

Internal Circuit

EX250-IE1

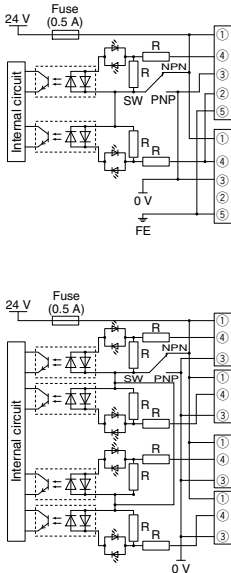

EX250-IE2

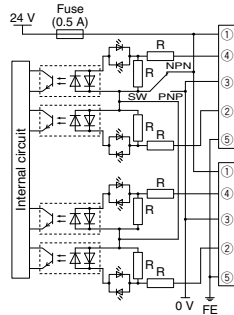

EX250-IE3

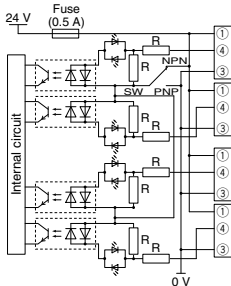

EX250 Series Accessories

Example of Connections

Connection example of an SI unit compatible with DeviceNet®, CANopen

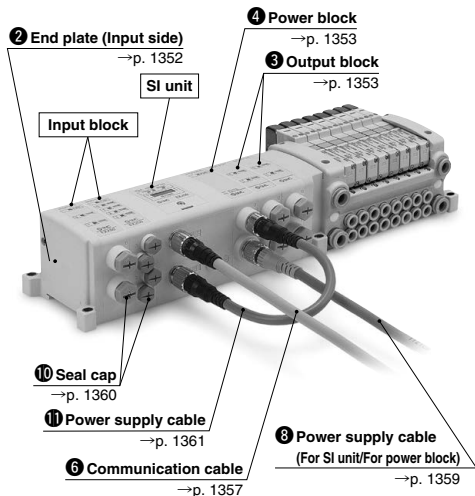

Connection example of an SI unit compatible with EtherNet/IP™, PROFIBUS DP

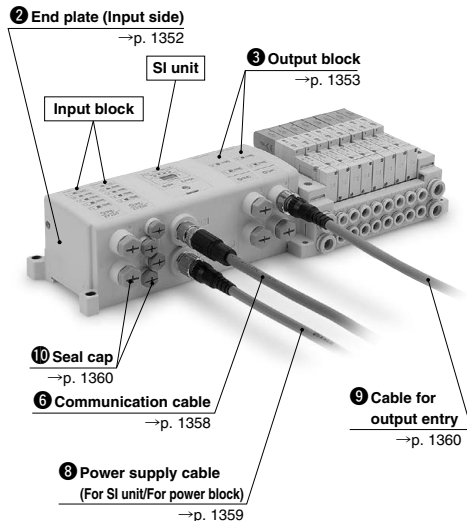

Connection example of an SI unit compatible with AS-Interface

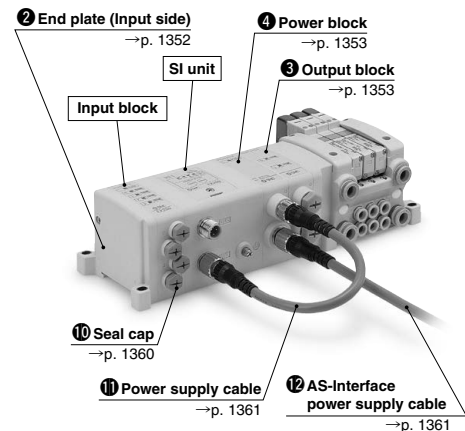

EX250 Series

① Replacement Fuse

Replacement fuse required when the fuse for the input block (EX250-IE□) overcurrent protection is blown.

EX9-FU05

Model	EX9-FU05
Applicable model	EX250-IE□
Rated current	0.5 A
Rated insulation capacity	48 VAC/DC 50 A
Fuse resistance value	0.36 Ω

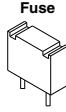

② End Plate (Input side)

EX250-EA 1

Mounting specification

- 1 Direct mounting
- 2 DIN rail mounting

Accessory
Hexagon socket head cap screw (M3 x 10): 2 pcs.

<Example of use>

End plate (Input side)



EX250-EA1

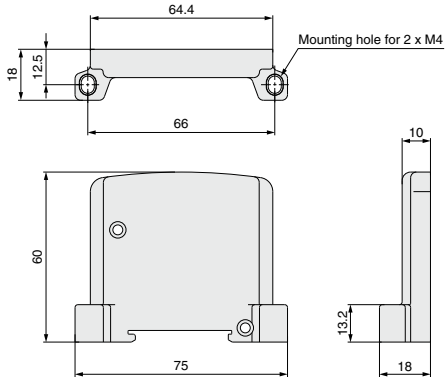

EX250-EA2

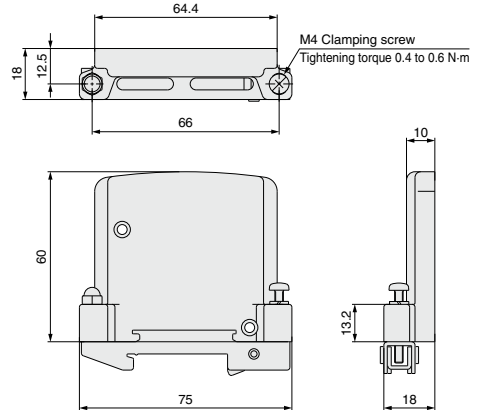

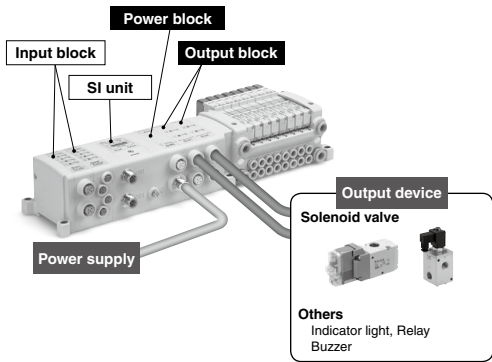

- Able to retrofit to the valve manifold, using the unused points
- 2-output (M12 connector)
- Positive/Negative common available as standard
- Able to drive by 0.5 A per point

You are requested to connect it to an SI unit and a valve manifold. For detailed specifications, refer to the operation manual that can be downloaded from SMC website, <https://www.smcworld.com>

3 Output Block

EX9-OE **T** **1**

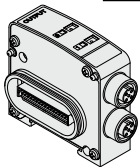

• Output specification

- | | |
|----------|------------------------------|
| 1 | Source/PNP (Negative common) |
| 2 | Sink/NPN (Positive common) |

• Power supply type

- | | |
|----------|--|
| T | Internal power supply method (for low-wattage load) |
| P | Integrated power supply method (for high-wattage load) ⁺¹ |

⁺¹ Required to connect with a power block

SI Unit/Part Nos.

SI unit part no.	Output	Applicable model
EX250-SDN1	Source/PNP (Negative common)	EX9-OET1
EX250-SAS□		EX9-OEP1
EX250-SEN1		

Option/Part Nos.

Description	Part no.	Applicable model		Note
		OET□	OEP□	
Seal cap	EX9-AWTS	○	○	Refer to page 1360. Order separately: 10 pcs. included
Cable for output entry	EX9-AC□-7	○	○	Refer to page 1360. Order separately.
Power block	EX9-PE1		○	Refer to page 1354. Order separately.

4 Power Block

EX9-PE1

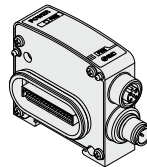

Option/Part Nos.

Description	Part no.	Note
Seal cap	EX9-AWTS	Refer to page 1360. Order separately: 10 pcs. included
Power supply cable (For SI unit/For power block)	EX9-AC□-1	Refer to page 1359. Order separately.
Power supply cable (For connecting the SI unit to the power block)	EX9-AC002-2 EX9-AC002-3 EX9-AC002-4	Refer to page 1361. Order separately.
AS-Interface power supply cable	EX9-AC□-5	Refer to page 1361. Order separately.

EX250 Series

③ Output Block/④ Power Block

Output Block Specifications

Model		EX9-OET1	EX9-OET2	EX9-OEP1	EX9-OEP2
Output connector		M12 connector (5 pins)			
Internal current consumption		40 mA or less			
Output	Output type	Source/PNP (Negative common)	Sink/NPN (Positive common)	Source/PNP (Negative common)	Sink/NPN (Positive common)
	Number of outputs	2 outputs			
	Power supply method	Internal power supply method		Integrated power supply method (Power block: supplied from EX9-PE1)	
	Output device supply voltage	24 VDC			
Output device supply current		Max. 62 mA/Point (1.5 W/Point)		Max. 0.5 A/Point (12 W/Point)	
Environmental resistance	Enclosure	IP67			
	Operating temperature range	-10 to +50°C			
	Operating humidity range	35 to 85%RH (No condensation)			
	Withstand voltage	1500 VAC for 1 minute between whole external terminal and FG			
Insulation resistance		10 MΩ or more (500 VDC) between whole external terminal and FG			
Standards		CE/UKCA marking, UL (CSA)			
Weight		120 g			
Accessory	Tie-rod	2 pcs.			

Power Block Specifications

Model		EX9-PE1
Connection block		Output block (EX9-OEP□)
Connection block stations		Output block: Max. 9 stations (excluding input blocks)*1
Power supply for output and internal control	Power supply voltage	22.8 to 26.4 VDC
	Internal power consumption	20 mA or less
Supply current		Max. 3.1 A (When using with 3.0 to 3.1 A, the ambient temperature should not exceed 40°C, and do not bundle the cable.)
Environmental resistance	Enclosure	IP67
	Operating temperature range	-10 to +50°C
	Operating humidity range	35 to 85%RH (No condensation)
	Withstand voltage	1500 VAC for 1 minute between whole external terminal and FG
Insulation resistance		10 MΩ or more (500 VDC) between whole external terminal and FG
Standards		CE/UKCA marking, UL (CSA)
Weight		120 g
Accessory	Tie-rod	2 pcs.
	Seal cap (for M12 connector socket)	1 pc. (EX9-AWTS)

*1 The total number of connectable input/output/power block to the EX250 series SI unit (except for AS-Interface compliant) is 10 stations at the maximum.

* For detailed specifications other than the above, refer to the operation manual that can be downloaded from SMC website, <https://www.smcworld.com>

Output Block Dimensions/Parts Description

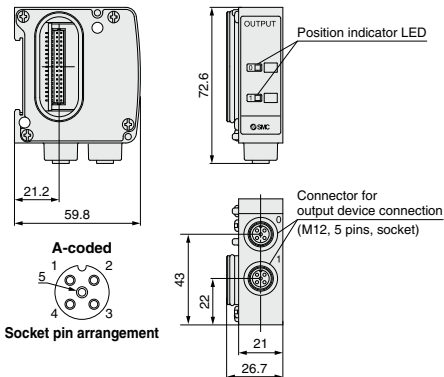

Power Block Dimensions/Parts Description

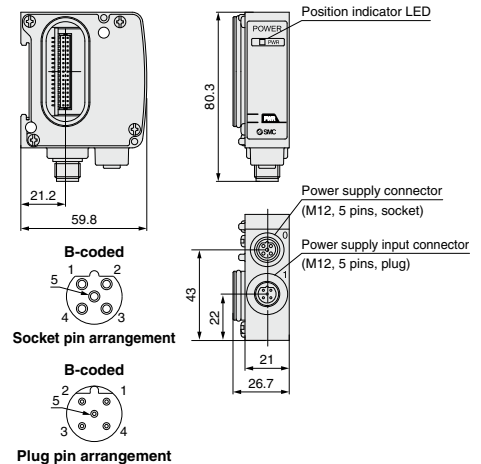

③ Output Block/④ Power Block

Circuit Diagram

EX9-OET1

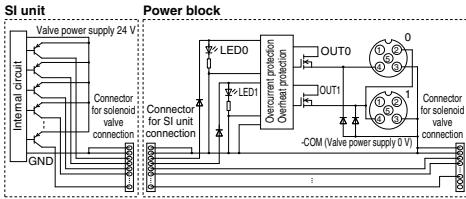

EX9-OET2

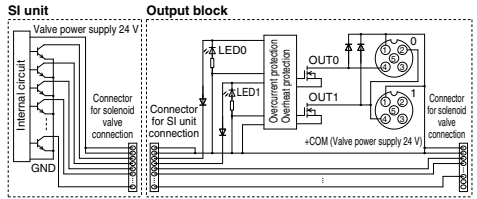

EX9-OEP1

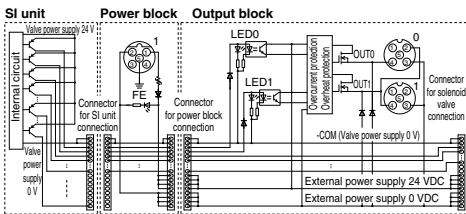

EX9-OEP2

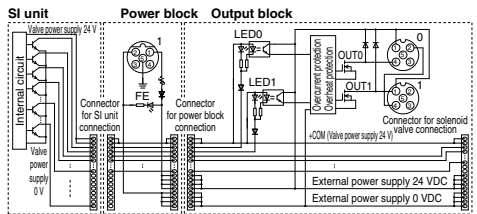

EX9-PE1

Power block

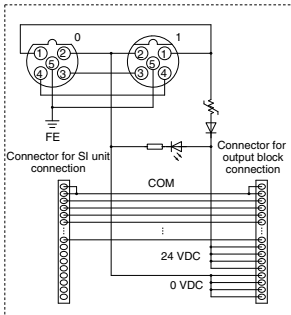

* When the valve which supplies power to the SI unit is turned OFF, the output of the output block (EX9-OE□) remains OFF.

EX250 Series

5 End Plate (Output side)

Use the end plate when a valve manifold is not connected.

EX9-EA 03

● Mounting specification

03	Direct mounting
04	DIN rail mounting

<Example of use>

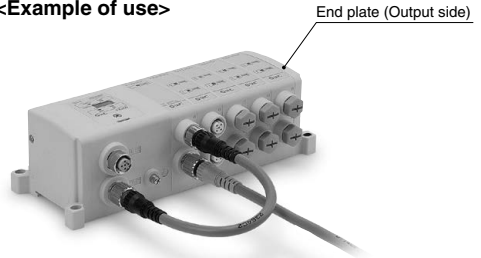

EX9-EA03

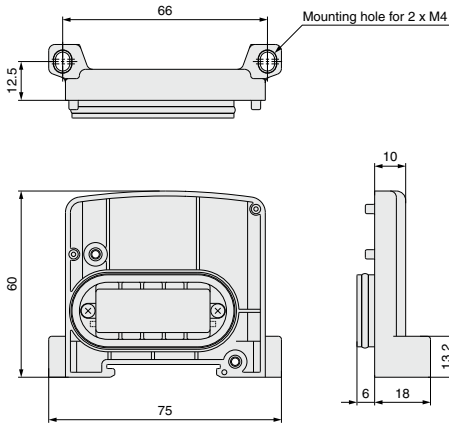

EX9-EA04

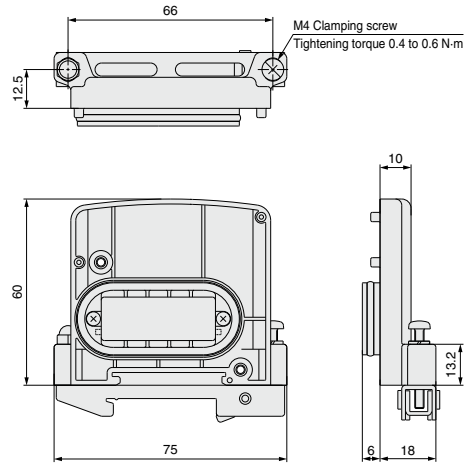

6 Communication Cable

For DeviceNet®

PCA-1557633

(Socket)

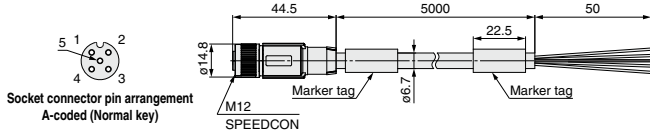

Socket connector pin arrangement
A-coded (Normal key)

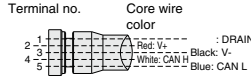

Connections

Item		Specifications
Cable O.D.		ø6.7 mm
Conductor nominal cross section	Power pair	0.34 mm ² /AWG22
	Data pair	0.25 mm ² /AWG24
Wire O.D. (Including insulator)	Power pair	1.4 mm
	Data pair	2.05 mm
Min. bending radius (Fixed)		67 mm



Made to Order

Cable length	10000 mm	p. 1362
--------------	----------	---------

EX9-AC 005 DN-SSPS (With connector on both sides (Socket/Plug))

Cable length (L)

005	500 mm
010	1000 mm
020	2000 mm
030	3000 mm
050	5000 mm
100	10000 mm

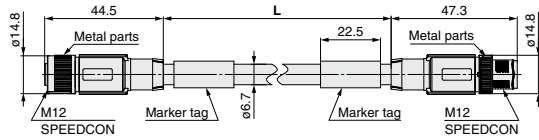

Socket connector pin arrangement
A-coded (Normal key)

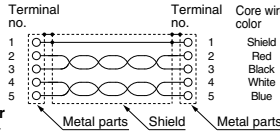

Connections

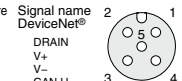

Plug connector pin arrangement
A-coded (Normal key)

Item		Specifications
Cable O.D.		ø6.7 mm
Conductor nominal cross section	Power pair	0.34 mm ² /AWG22
	Data pair	0.25 mm ² /AWG24
Wire O.D. (Including insulator)	Power pair	1.4 mm
	Data pair	2.05 mm
Min. bending radius (Fixed)		67 mm

EX250 Series

⑥ Communication Cable

For EtherNet/IP™

EX9-AC 020 EN-PSRJ (Plug/RJ-45 connector)

● Cable length (L)

010	1000 mm
020	2000 mm
030	3000 mm
050	5000 mm
100	10000 mm

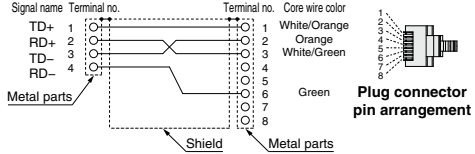
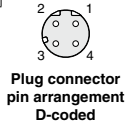
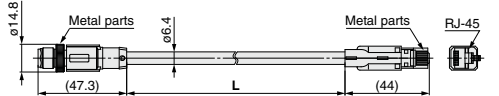

Connections (Straight cable)

Item	Specifications
Cable O.D.	ø6.4 mm
Conductor nominal cross section	0.14 mm ² /AWG26
Wire O.D. (Including insulator)	0.98 mm
Min. bending radius (Fixed)	26 mm

EX9-AC 005 EN-PSPS (With connector on both sides (Plug/Plug))

● Cable length (L)

005	500 mm
010	1000 mm
020	2000 mm
030	3000 mm
050	5000 mm
100	10000 mm

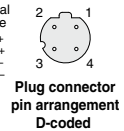
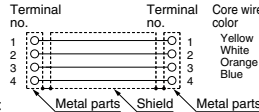
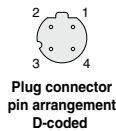
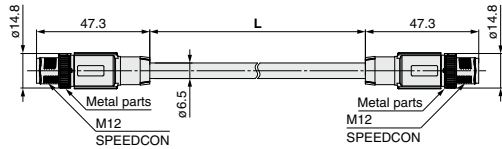

Connections (Straight cable)

Item	Specifications
Cable O.D.	ø6.5 mm
Conductor nominal cross section	0.34 mm ² /AWG22
Wire O.D. (Including insulator)	1.55 mm
Min. bending radius (Fixed)	19.5 mm

7 Field-wireable Communication Connector

Plug

For DeviceNet®
PCA-1075528

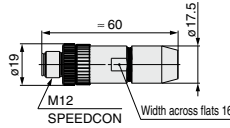

Applicable Cable

Item	Specifications
Cable O.D.	4.0 to 8.0 mm
Wire gauge (Stranded wire cross section)	0.14 to 0.75 mm ² /AWG26 to 18 (Solid cable/Flexible cable) 0.08 to 0.5 mm ² /AWG28 to 20 (With ferrule)

Socket

For DeviceNet®
PCA-1075529

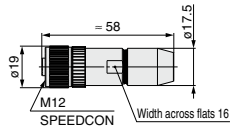

Applicable Cable

Item	Specifications
Cable O.D.	4.0 to 8.0 mm
Wire gauge (Stranded wire cross section)	0.14 to 0.75 mm ² /AWG26 to 18 (Solid cable/Flexible cable) 0.08 to 0.5 mm ² /AWG28 to 20 (With ferrule)

8 Power Supply Cable (For SI unit/For power block)

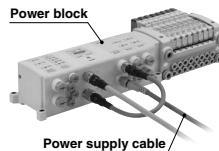
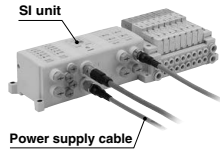

For DeviceNet® For Power block

Straight connector type

EX9-AC [050] - 1

Cable length (L)

010	1000 mm
030	3000 mm
050	5000 mm

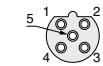

Socket connector pin arrangement B-coded

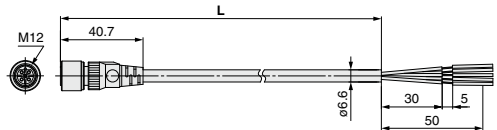

Item	Specifications
Cable O.D.	ø6.6 mm
Conductor nominal cross section	AWG22
Wire O.D. (Including insulator)	1.65 mm
Min. bending radius (Fixed)	40 mm



Made to Order

Cable length	10000 mm	p. 1363
--------------	----------	---------

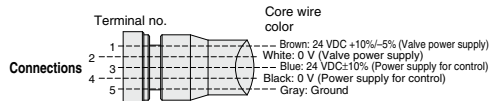

EX250 Series

8 Power Supply Cable (For SI unit)

For EtherNet/IP™

EX500-AP **050** - S

Cable length (L)

010	1000 mm
050	5000 mm

Connector specification

S	Straight
---	----------

Straight connector type

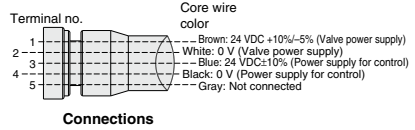
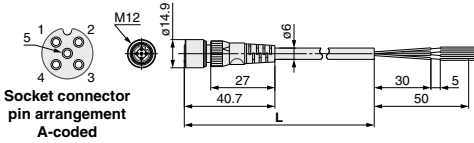

Made to Order

Cable length	10000 mm	p. 1363
--------------	----------	---------

Item	Specifications
Cable O.D.	ø6 mm
Conductor nominal cross section	0.3 mm ² /AWG22
Wire O.D. (Including insulator)	1.5 mm
Min. bending radius (Fixed)	40 mm

9 Cable for Output Entry

Connects the output block to the output device

EX9-AC **030** -7

Cable length (L)

010	1000 mm
030	3000 mm

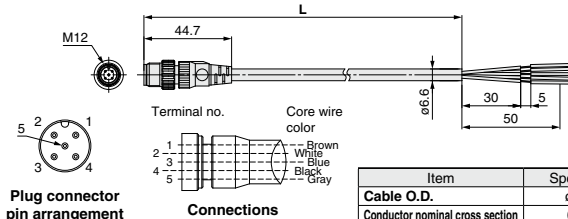
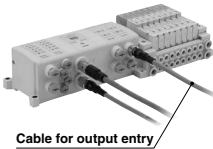

Item	Specifications
Cable O.D.	ø6.6 mm
Conductor nominal cross section	0.3 mm ²
Wire O.D. (Including insulator)	1.65 mm
Min. bending radius (Fixed)	40 mm

10 Seal Cap (10 pcs.)

Use this on ports that are not being used for an M8 or M12 connector (socket). Use of this seal cap maintains the integrity of the enclosure. (Seal caps are packed together with each unit.)

* Tighten the seal caps with the prescribed tightening torque. (For M8: 0.05 N·m, For M12: 0.1 N·m)

EX9-AW **ES**

Connector type

ES	M8 connector (For socket), 10 pcs.
TS	M12 connector (For socket), 10 pcs.

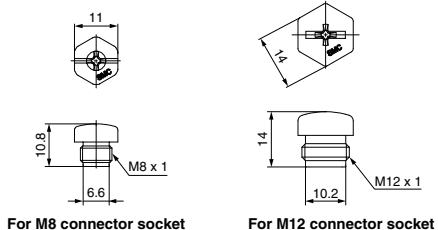
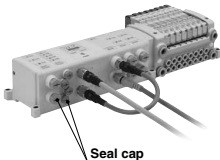

⑪ Power Supply Cable (For connecting the SI unit to the power block)

Connects between the power supply connector for the power block and the SI unit power supply connector, bridging the external power supply, which is supplied with the power block, to the SI unit.

EX9-AC002-2

SI unit type

2	EX250-SDN1 Compliant
3	EX250-SEN1 Compliant
4	EX250-SAS3/5 Compliant

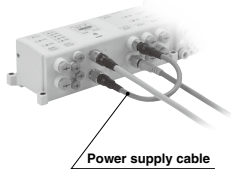

EX9-AC002-2

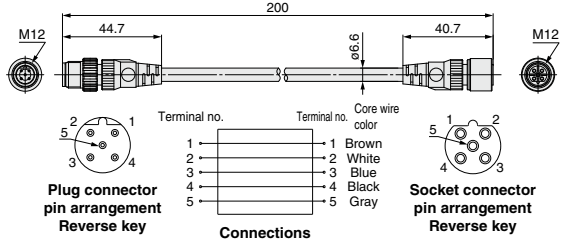

EX9-AC002-3

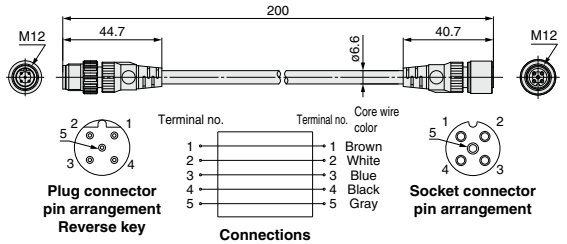

EX9-AC002-4

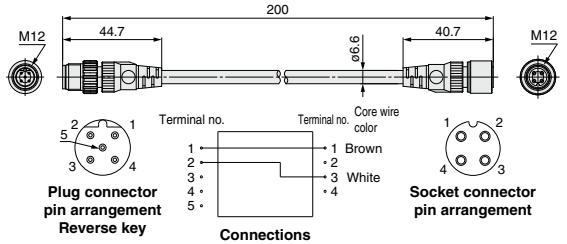

Item	Specifications
Cable O.D.	ø6.6 mm
Conductor nominal cross section	0.3 mm ²
Wire O.D. (Including insulator)	1.65 mm
Min. bending radius (Fixed)	40 mm

⑫ AS-Interface Power Supply Cable

Cable connecting between AS-Interface power supply line (for external devices) branch connector (M12) and the power block's power supply input connector.

EX9-AC 010 -5

Cable length (L)

010	1000 mm
030	3000 mm
050	5000 mm

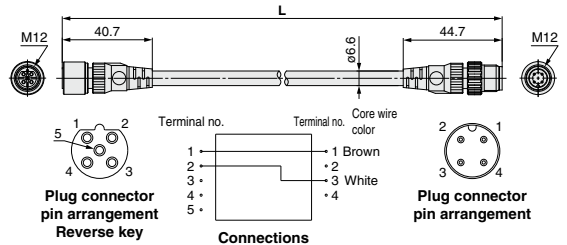

Item	Specifications
Cable O.D.	ø6.6 mm
Conductor nominal cross section	0.3 mm ²
Wire O.D. (Including insulator)	1.65 mm
Min. bending radius (Fixed)	40 mm

EX250 Series

Made to Order

Please contact SMC for detailed specifications and lead times.

SI Unit

Prepare the SI unit, each type of block, and the manifold valve (without SI unit) separately, and combine them before use.

- ① **DeviceNet[®], 7/8 inch connector, 32 inputs/32 outputs**
(Occupied points: 48 inputs (32 inputs + diagnostic 16 inputs)/32 outputs)

EX250-SDN1-X122

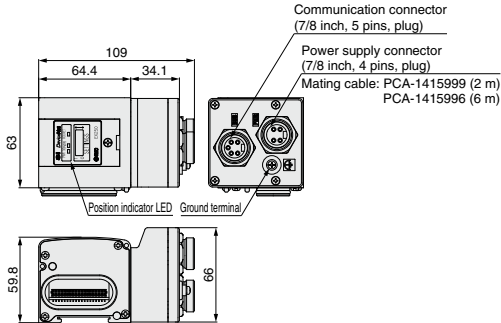

Power supply connector



1	24 VDC +10%/−5% (For valve)
2	Unused
3	FE
4	0 VDC (For valve)

Communication connector



1	DRAIN
2	V+
3	V−
4	CAN H
5	CAN L

* When connecting to a VQC4000 series model, use a VVQC4000-3A-3□, etc., D side end plate. The VVQC4000-3A-2□ D side end plate used by the standard EX250-SDN1 model cannot be used as it will come into contact with the EX250-SDN1-X122.

Communication Cable

- ① **With connector on one side (Socket)**
 Cable length: 10000 mm

For DeviceNet[®]

EX9-AC100DN-X12

Applicable
 protocol

DN	DeviceNet [®]
----	------------------------



Socket connector
 pin arrangement
 A-coded (Normal key)

For DeviceNet[®]

Dimensions

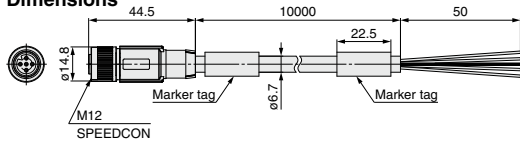

Connections

Terminal no.	Core wire color: Signal name (DeviceNet [®])
1	Shield: DRAIN
2	Red: V+
3	Black: V−
4	White: CAN H
5	Blue: CAN L

Item		Specifications
Cable O.D.		ø6.7 mm
Conductor nominal cross section	Power pair	0.34 mm ² /AWG22
	Data pair	0.25 mm ² /AWG24
Wire O.D. (Including insulator)	Power pair	1.4 mm
	Data pair	2.05 mm
Min. bending radius (Fixed)		67 mm

Power Supply Cable

② With connector on one side (Socket)

Cable length: 10000 mm

For EtherNet/IP™

Straight connector type

EX500-AP100-S-X1

● Connector specification

S	Straight
---	----------

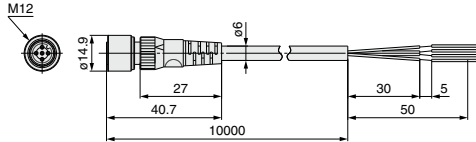

Socket connector pin arrangement
A-coded

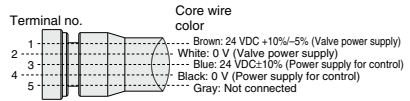

Connections (EtherNet/IP™)

Item	Specifications
Cable O.D.	ø6 mm
Conductor nominal cross section	0.3 mm ² /AWG22
Wire O.D. (Including insulator)	1.5 mm
Min. bending radius (Fixed)	40 mm



EX250 Series Specific Product Precautions

Be sure to read this before handling the products. Refer to page 7 for safety instructions and pages 15 to 17 for fieldbus system precautions.

When one AS-Interface power supply system is used

⚠ Caution

	EX250-SAS7	EX250-SAS9
Power supply voltage	Supplied from AS-Interface circuit, 26.5 to 31.6 VDC*1	
Internal current consumption	Max. 100 mA	Max. 65 mA
Input/output specification	Number of inputs	4
	Number of outputs	8
	Supply voltage	24 VDC
Supply current*2	Max. 240 mA	Max. 120 mA

*1 For communication power supply, use a power supply dedicated to AS-Interface. For details, please refer to operation manuals provided by the respective manufacturers.

*2 The AS-Interface circuit provides current to the internal parts of the SI unit and all connected equipment.

Since there is a limit on the possible supply current to all connected equipment, select the equipment connected to the input/output device to stay within the possible supply current.

Example) When EX250-SAS9 is used

Valve: VQC1100NY – 5 (low-wattage type of 0.5 W) x 4 pcs.
 $0.5 \text{ [W]} \div 24 \text{ [V]} \times 4 \text{ [pcs.]} = 84 \text{ [mA]} \text{ (4 outputs simultaneously ON)}$

The maximum possible supply current of EX250-SAS9 is 120 mA. Therefore, the possible supply current to the sensor is
 $120 \text{ [mA]} - 84 \text{ [mA]} = 36 \text{ [mA]}$

Use of low-wattage type valves by minimizing the maximum number of simultaneous outputs, and low current consumption sensors (2-wire sensor, etc.) is recommended.

Maximum number of AS-Interface compatible input blocks

SI unit specifications		Input block type	Input block maximum stations
EX250-SAS3	AS-Interface 8in/8out, 2 power supply systems	1 M12/2 inputs	4 stations
		2 M12/4 inputs	2 stations
		3 M8/4 inputs	2 stations
EX250-SAS5	AS-Interface 4in/4out, 2 power supply systems	1 M12/2 inputs	2 stations
		2 M12/4 inputs	1 station
		3 M8/4 inputs	1 station
EX250-SAS7	AS-Interface 8in/8out, 1 power supply system	1 M12/2 inputs	4 stations
		2 M12/4 inputs	2 stations
		3 M8/4 inputs	2 stations
EX250-SAS9	AS-Interface 4in/4out, 1 power supply system	1 M12/2 inputs	2 stations
		2 M12/4 inputs	1 station
		3 M8/4 inputs	1 station

Operating Environment

⚠ Caution

1. Select the proper type of enclosure according to the environment of operation.

IP65 is achieved when the following conditions are met.

- 1) Provide appropriate wiring between all units using electrical wiring cables, communication connectors and cables with M12 connectors.
- 2) Suitable mounting of each unit and valve manifold.
- 3) Be sure to mount a seal cap on any unused connectors. If using in an environment that is exposed to water splashes, please take measures such as using a cover.

■ Trademark

Modbus® is a registered trademark of Schneider Electric, licensed to the Modbus Organization, Inc.
 DeviceNet® is a registered trademark of ODVA, Inc.
 EtherNet/IP® is a registered trademark of ODVA, Inc.
 QuickConnect™ is a trademark of ODVA.