

# Refrigerated Air Dryers

## IDF/IDU Series

### Protect Pneumatic Equipment from Moisture!

An air dryer removes the vapor from the moist compressed air delivered by the compressor, and prevents it from causing the pneumatic equipment to fail.

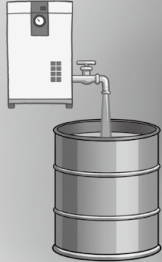

This is how much moisture is actually contained in compressed air!  
**113 L = approx. 63 1.8 L bottles**



<Conditions> • Air compressor output: 75 kW  
 • Air at 30°C and a relative humidity of 80% compressed to 0.7 MPa  
 • 8 hours of operation

#### Standard inlet air temperature type IDF□E/F/D Series

##### • Tolerant of high temperature environment!

Top of its class in the industry for the large air-cooled type  
**Ambient temperature 45°C/Inlet air temperature 65°C (IDF60 to 90)**

• Air flow capacity increased by max. 41% compared with the existing model (IDF60 to 90)

Model	Rated inlet condition	Applicable air compressor [kW]	Port size	Page
IDF1E	35°C 0.7 MPa	0.75	Rc3/8	42
IDF2E		1.5		
IDF3E		2.2		
IDF4E		3.7	Rc1/2	
IDF6E		5.5	Rc3/4	
IDF8E		7.5		
IDF11E		11		
IDF15E1		15	Rc1	
IDF60	22	R1		
IDF160 or IDF70	37	R1 or R1 1/2		
IDF80	55	R2		
IDF80 or IDF90	75			



##### • Large size series

##### • Tolerant of high temperature environment!

Top of its class in the industry for the large air-cooled type  
**Ambient temperature 45°C/Inlet air temperature 60°C (IDF100F to 150F)**

##### • Energy saving design

Exhaust heat amount is reduced 25% to suppress the ambient temperature rise (air-cooled type) and reduce the facility water amount (water-cooled type) (IDF100F to 150F).

Model	Rated inlet condition	Applicable air compressor [kW]	Port size	Page
IDF100F	40°C 0.7 MPa	100	R2	47
IDF125F		125	65 (2 1/2B) Flange	
IDF150F		150	80 (3B) Flange	
IDF190D		190		
IDF240D		240	100 (4B) Flange	
IDF370D	35°C 0.7 MPa	370	150 (6B) Flange	52

Refer to page 127 and on and page 157 and on for dryer models compliant with international standards (CE/UKCA marked products and UL standards compliant products).

#### High inlet air temperature type IDU□E Series

##### • Energy-saving design

The use of an aftercooler allows for the load on the compressor for refrigeration to be greatly reduced.

(Power consumption: Reduced by up to 50%) Refer to page 35-1 for details.

\* IDU8E to 75E

Model	Rated inlet condition	Applicable air compressor [kW]	Port size	Page	
IDU3E	55°C 0.7 MPa	2.2	Rc3/8	55	
IDU4E		3.7	Rc1/2		
IDU6E		5.5	Rc3/4		
IDU8E		7.5			
IDU11E		11			
IDU15E1		15	Rc1		58
IDU22E		22	R1		
IDU37E		37	R1 1/2		
IDU55E		55	R2		
IDU75E		75			



# Refrigerated Air Dryer *IDF/IDU Series*

## The importance of dryers

Air dryers remove the vapor from the moist compressed air delivered by the compressor and prevent it from causing the pneumatic equipment to fail.



- Malfunctioning of valves and actuators caused by dripping grease
- Generation of water droplets
- Decomposition of auto drain caused by rusting inside pipes

### Malfunction of air blowers/air drivers

Generation of water droplets



### Generation of drain and outflow to the secondary side

Decomposition of auto drain caused by rusting inside pipes

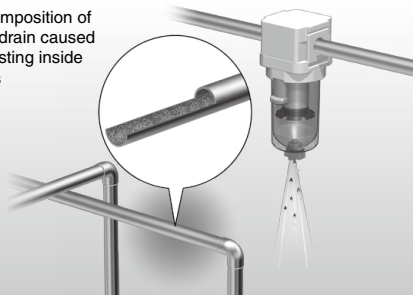

### Component failure and frequent replacement

Malfunctioning of valves and actuators caused by dripping grease

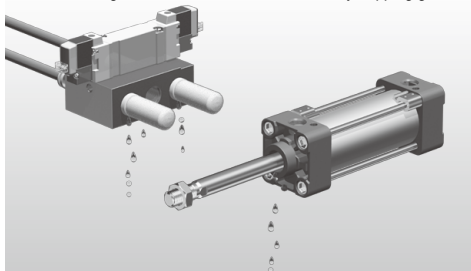

### Stopping of machines



## High inlet air temperature type IDU8E to 75E Series

### Energy saving design

# Max.50% reduction

The use of an aftercooler allows for the load on the compressor for refrigeration to be greatly reduced.

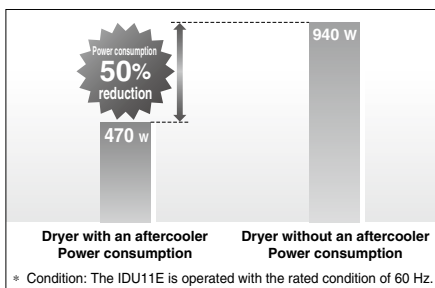



# Refrigerated Air Dryer

## IDF100F/125F/150F Series

Tolerant of high temperature environment (ambient temperature 45°C), Energy saving design!

● Air-cooled type can be used at ambient temperature 45°C.

Second re-heater helps the heat radiation of the condenser allow use at ambient temperature 45°C.

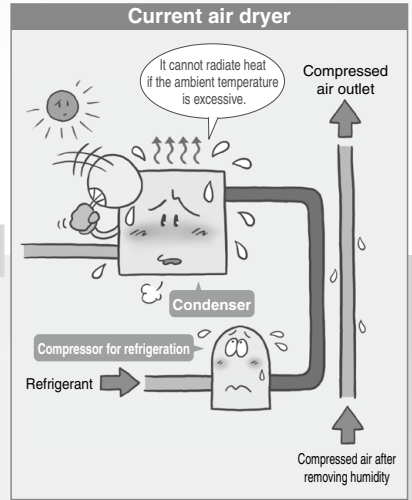
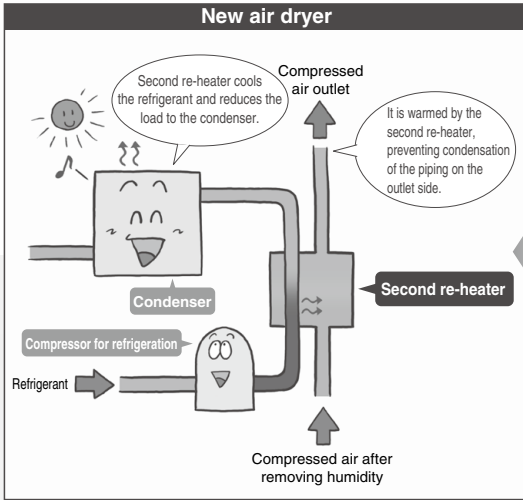

● Energy saving design: Reduces exhaust heat from air dryer by up to 25%.

Suppresses ambient temperature increase (air-cooled type)/ Reduces amount of facility water (water-cooled type)!

Second re-heater reduces the load to the condenser, and reduces exhaust heat from air dryer by up to 25%. (comparison with other SMC products)

● Reduced exhaust heat achieves downsizing and energy saving operation of the air conditioner!

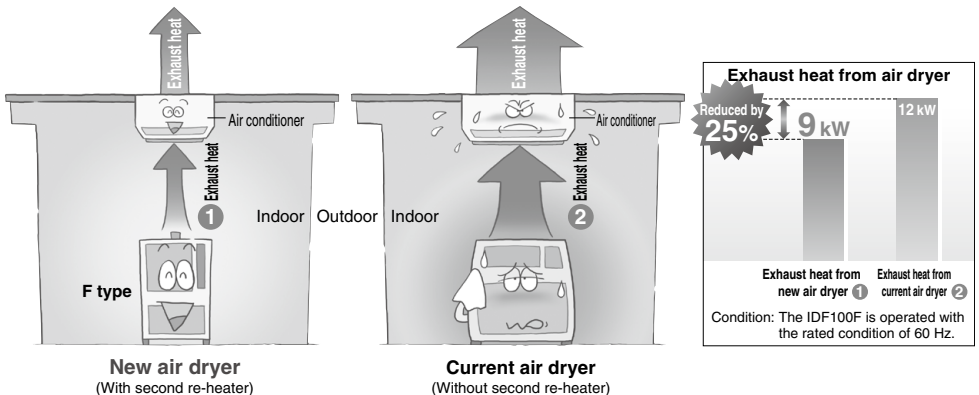

## Maintenance

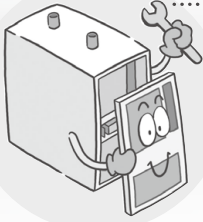

- Dustproof filter provided as a standard accessory
- Only access from front side is required to check electrical equipment and dustproof filter.

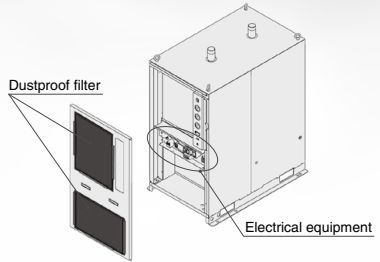

## Selection of layout

### [Air-cooled type]

Exhausting direction can be selected from **four directions!!**  
Auto drain tube can be connected in **two directions**, left or right.

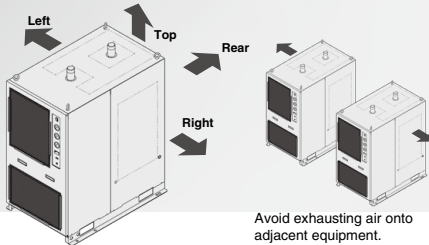
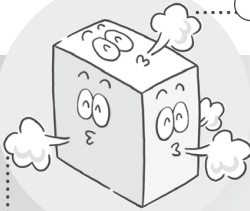

Avoid exhausting air onto adjacent equipment.

### [Water-cooled type]

Facility water piping port can be selected from **two directions!!**

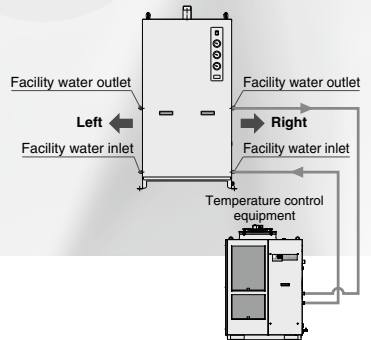
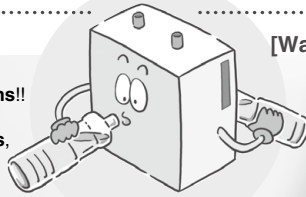

HRS100/150 series

## Space saving

Either the left or right can be installed flat against a wall! \*1  
Installation space can be reduced by up to 1.5 m<sup>2</sup>!!

\*1 For air-cooled type, leave a space of at least 600 mm between the heat exhausting surface and the wall.  
For water-cooled type, leave a space at least 600 mm between the facility water piping side and the wall.

Leave at least 600 mm on the sides indicated with ←→.

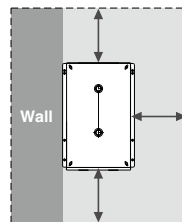
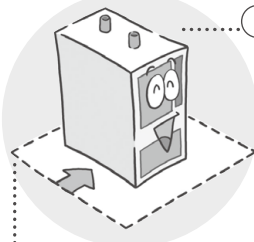

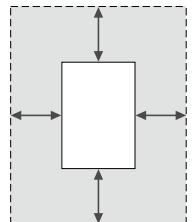

Installation space of the IDF100F (Example: Installed flat against the wall on the left)



Installation space of the current type

# Contents

**Standard Inlet Air Temperature Type**
**IDF□E/F/D Series**
**Rated inlet air temperature: 35, 40°C**

Model	Rated inlet condition	Air flow capacity [m <sup>3</sup> /min(ANR)]		Applicable air compressor [kW]	Refrigerant	Port size	Page
		50 Hz	60 Hz				
	IDF1E	0.1	0.12	0.75	R134a (HFC)	Rc3/8	42 to 45
	IDF2E	0.2	0.235	1.5			
	IDF3E	0.32	0.37	2.2			
	IDF4E	0.52	0.57	3.7			
	IDF6E	0.75	0.82	5.5		Rc3/4	
	IDF8E	1.22	1.32	7.5			
	IDF11E	1.65	1.82	11			
	IDF15E1	2.8	3.1	15		Rc1	
	IDF60	5.6	6.5	22	R410A (HFC)	R1	
	IDF60 or IDF70	5.6 or 8.0	6.5 or 9.1	37		R1 or R1 1/2	
IDF80	11.6	13.6	55	R2			
	11.6 or 14.3	13.6 or 16.4	75				
	IDF100F	16.0	18.8	100	R407C (HFC)	65(2 1/2B) Flange	47 to 54
	IDF125F	20.1	23.7	125			
	IDF150F	25.0	30.0	150		80(3B) Flange	
	IDF190D	32.0	38.0	190		100(4B) Flange	
	IDF240D	43.0	50.0	240		150(6B) Flange	
	IDF370D	54.0	65.0	370			

**High Inlet Air Temperature Type**
**IDU□E Series**
**Rated inlet air temperature: 55°C**

Model	Rated inlet condition	Air flow capacity [m <sup>3</sup> /min(ANR)]		Applicable air compressor [kW]	Refrigerant	Port size	Page
		50 Hz	60 Hz				
	IDU3E	0.32	0.37	2.2	R134a (HFC)	Rc3/8	55 to 57
	IDU4E	0.52	0.57	3.7		Rc1/2	
	IDU6E	0.75	0.82	5.5		Rc3/4	
	IDU8E	1.1	1.2	7.5			
	IDU11E	1.5	1.7	11		R407C (HFC)	
	IDU15E1	2.6	2.8	15			
	IDU22E	3.9	4.3	22	R1		
	IDU37E	5.7	6.1	37	R1 1/2		
	IDU55E	8.4	9.8	55	R2		
	IDU75E	11.0	12.5	75		R2	

Refer to page 127 and on and page 157 and on for dryer models compliant with international standards (CE/UKCA marked products and UL standards compliant products).

## Options

Description	Applicable model	Model (Suffix: Option symbol)	Page
<b>Cool compressed air output</b>	IDF1E to 15E1	IDF□E-□-A	61, 62
	IDF1E to 15E1	IDF□E-□-C	
<b>Anti-corrosive treatment for copper tube</b>	IDF100F to 150F	IDF□F-□-C	
	IDF190D to 370D	IDF□D-□(-□)-C	
	IDU3E to 15E1	IDU□E-□-C	
<b>With Chinese labels and a Chinese operation manual</b>	IDF1E to 15E1	IDF□E-□-G	
	IDU3E to 15E1	IDU□E-□-G	
<b>Moderate pressure specification (up to 1.6 MPa)</b>	IDF6E to 15E1	IDF□E-□-K	
	IDU3E to 15E1	IDU□E-□-K	
	IDF100F to 150F	IDF□F-□-K	
<b>With a heavy-duty auto drain<sup>*1</sup> (applicable to moderate pressure)</b>	IDF4E to 15E1	IDF□E-□-L	
	IDF370D	IDF370D-□-L	
	IDU3E to 15E1	IDU□E-□-L	
<b>With a motor type auto drain<sup>*2</sup></b>	IDF4E to 15E1	IDF□E-□-M	63
	IDF190D, 240D	IDF□D-□(-□)-M	
	IDU3E to 15E1	IDU□E-□-M	
<b>With a metal name plate</b>	IDF100F to 150F	IDF□F-□-P	63
	IDF4E to 15E1	IDF□E-□-R	
<b>With an earth leakage breaker</b>	IDF100F to 150F	IDF□F-□-R	64
	IDF190D to 370D	IDF□D-3-R	
	IDU3E to 15E1	IDU□E-□-R	
<b>Power supply terminal block connection</b>	IDF1E to 15E1-10	IDF□E-10-S	65
	IDU3E to 15E1-10	IDU□E-10-S	
<b>With a terminal block for power supply, operating, and error signals<sup>*3</sup></b>	IDF4E to 15E1	IDF□E-□-T	
	IDU3E to 15E1	IDU□E-□-T	
<b>With a timer controlled solenoid valve type auto drain (applicable to moderate pressure)</b>	IDU3E to 15E1	IDU□E-□-V	
	IDF100F to 150F	IDF□F-□-V	
<b>Water-cooled type<sup>*2</sup></b>	IDF100F to 150F	IDF□F-□-W	66
	IDF190D, 240D	IDF□D-3-W	

\*1 The IDF100F to 150F, 190D, 240D standard types are equipped with a heavy-duty auto drain and a terminal block for remote operation, stop, operating, and error signal.

\*2 The IDF370D standard type is the water-cooled type with a motor type auto drain.

\*3 When switching from the previous air dryer and remote operation are required, select the Made to Order (IDF/U□E-□-X256) product.

The IDF100F to 150F and 190D to 370D standard types are equipped with a terminal block for remote operation, stop, operating, and error signals.

## Optional Accessories

Description	Page
<b>Separately installed power transformer</b>	67 to 75
<b>Dedicated base for separately installed power transformer</b>	
<b>Dust-protecting filter set</b>	
<b>Bypass piping set</b>	
<b>Foundation bolt set</b>	
<b>Piping adapter</b>	
<b>Mounting base adapter</b>	
<b>Conversion piping set</b>	
<b>Conversion bypass piping set</b>	

# IDF/IDU Series Model Selection

The corrected air flow capacity, which considers the user's operating conditions, is required for selecting air dryer. Select using the following procedures.

<b>1</b> Select the IDF or IDU.	Select the IDF or IDU from inlet air temperature used. • Inlet air temperature 5 to 50°C ..... IDF (For IDF100F to 150F, up to 60°C is allowed.) • Inlet air temperature 50 to 80°C ..... IDU																																																																	
<b>2</b> Read the correction factors.	<table border="1" style="width: 100%; text-align: center;"> <thead> <tr> <th colspan="4">IDF Selection Example</th> </tr> <tr> <th>Condition</th> <th>Data symbol</th> <th>Correction factor*1</th> <th></th> </tr> </thead> <tbody> <tr> <td>Inlet air temperature</td> <td>40°C</td> <td>(A)</td> <td>0.82</td> </tr> <tr> <td>Ambient temperature</td> <td>35°C</td> <td>(B)</td> <td>0.96</td> </tr> <tr> <td>Outlet air pressure dew point</td> <td>10°C</td> <td>(C)</td> <td>1</td> </tr> <tr> <td>Inlet air pressure</td> <td>0.5 MPa</td> <td>(D)</td> <td>0.88</td> </tr> <tr> <td>Air flow rate</td> <td>0.3 m<sup>3</sup>/min</td> <td>—</td> <td>—</td> </tr> <tr> <td>Power supply frequency</td> <td>50 Hz</td> <td>—</td> <td>—</td> </tr> </tbody> </table> <p>*1 Values obtained from "Correction Factors" on page 41.          * The outlet air pressure dew point varies depending on the operating conditions.          Particularly when the outlet air pressure dew point is 3°C or 5°C, though this depends on the operating conditions, freeze protection functions may be activated, resulting in the dew point rising and becoming unstable.          If a stable low dew point is required, consider an IDG series membrane air dryer or an ID series heatless air dryer.</p>	IDF Selection Example				Condition	Data symbol	Correction factor*1		Inlet air temperature	40°C	(A)	0.82	Ambient temperature	35°C	(B)	0.96	Outlet air pressure dew point	10°C	(C)	1	Inlet air pressure	0.5 MPa	(D)	0.88	Air flow rate	0.3 m <sup>3</sup> /min	—	—	Power supply frequency	50 Hz	—	—	<table border="1" style="width: 100%; text-align: center;"> <thead> <tr> <th colspan="4">IDU Selection Example</th> </tr> <tr> <th>Condition</th> <th>Data symbol</th> <th>Correction factor*1</th> <th></th> </tr> </thead> <tbody> <tr> <td>Inlet air temperature</td> <td>60°C</td> <td>(A)</td> <td>0.95</td> </tr> <tr> <td>Ambient temperature</td> <td>35°C</td> <td>(B)</td> <td>0.93</td> </tr> <tr> <td>Outlet air pressure dew point</td> <td>10°C</td> <td>(C)</td> <td>1</td> </tr> <tr> <td>Inlet air pressure</td> <td>0.5 MPa</td> <td>(D)</td> <td>0.88</td> </tr> <tr> <td>Air flow rate</td> <td>0.4 m<sup>3</sup>/min</td> <td>—</td> <td>—</td> </tr> <tr> <td>Power supply frequency</td> <td>60 Hz</td> <td>—</td> <td>—</td> </tr> </tbody> </table> <p>*1 Values obtained from "Correction Factors" on page 41.          * The outlet air pressure dew point varies depending on the operating conditions.          Particularly when the outlet air pressure dew point is 3°C or 5°C, though this depends on the operating conditions, freeze protection functions may be activated, resulting in the dew point rising and becoming unstable.          If a stable low dew point is required, consider an IDG series membrane air dryer or an ID series heatless air dryer.</p>	IDU Selection Example				Condition	Data symbol	Correction factor*1		Inlet air temperature	60°C	(A)	0.95	Ambient temperature	35°C	(B)	0.93	Outlet air pressure dew point	10°C	(C)	1	Inlet air pressure	0.5 MPa	(D)	0.88	Air flow rate	0.4 m <sup>3</sup> /min	—	—	Power supply frequency	60 Hz	—	—
IDF Selection Example																																																																		
Condition	Data symbol	Correction factor*1																																																																
Inlet air temperature	40°C	(A)	0.82																																																															
Ambient temperature	35°C	(B)	0.96																																																															
Outlet air pressure dew point	10°C	(C)	1																																																															
Inlet air pressure	0.5 MPa	(D)	0.88																																																															
Air flow rate	0.3 m <sup>3</sup> /min	—	—																																																															
Power supply frequency	50 Hz	—	—																																																															
IDU Selection Example																																																																		
Condition	Data symbol	Correction factor*1																																																																
Inlet air temperature	60°C	(A)	0.95																																																															
Ambient temperature	35°C	(B)	0.93																																																															
Outlet air pressure dew point	10°C	(C)	1																																																															
Inlet air pressure	0.5 MPa	(D)	0.88																																																															
Air flow rate	0.4 m <sup>3</sup> /min	—	—																																																															
Power supply frequency	60 Hz	—	—																																																															
<b>3</b> Check the coefficient.	Correction factor = 0.82 x 0.96 x 1 x 0.88 = 0.69 Max. coefficient value is 1.5. Correction factor is 1.5 when the calculation result is 1.5 or greater.	Correction factor = 0.95 x 0.93 x 1 x 0.88 = 0.78 Max. coefficient value is 1.5. Correction factor is 1.5 when the calculation result is 1.5 or greater.																																																																
<b>4</b> Calculate the corrected air flow capacity. Obtain the corrected air flow capacity from the following formula. Corrected air flow capacity = Air flow rate ÷ (Correction factor (A) x (B) x (C) x (D))	<p style="text-align: center;">Corrected air flow capacity = 0.3 m<sup>3</sup>/min ÷ (0.82 x 0.96 x 1 x 0.88)          = 0.43 m<sup>3</sup>/min</p>	<p style="text-align: center;">Corrected air flow capacity = 0.4 m<sup>3</sup>/min ÷ (0.95 x 0.93 x 1 x 0.88)          = 0.51 m<sup>3</sup>/min</p>																																																																
<b>5</b> Select the model. Select the model with air flow capacity which exceeds the corrected air flow capacity from the specification table. (For air flow capacity, refer to the data (E) on page 41.)	According to the corrected air flow capacity of 0.43 m <sup>3</sup> /min, the <b>IDF4E</b> will be selected which air flow capacity is 0.52 m <sup>3</sup> /min at 50 Hz.	According to the corrected air flow capacity of 0.51 m <sup>3</sup> /min, the <b>IDU4E</b> will be selected which air flow capacity is 0.57 m <sup>3</sup> /min at 60 Hz.																																																																
<b>6</b> Options	Refer to pages 61 to 66.	Refer to pages 61 to 66.																																																																
<b>7</b> Finalize the model number.	Refer to pages 42, 46, 47, 52.	Refer to pages 55 and 58.																																																																
<b>8</b> Select the optional accessories.	Refer to pages 67 to 75.																																																																	



**Correction Factors**

**Data (A): Inlet Air Temperature**

**IDF Series**

**IDF1E to 15E1**

Inlet air temp. [°C]	Correction factor
5 to 30	1.3
35	1
40	0.82
45	0.68
50	0.57

**IDF190D to 240D**

Inlet air temp. [°C]	Correction factor
5 to 30	1.35
35	1.25
40	1
45	0.8
50	0.6

**IDF100F to 150F**

Inlet air temp. [°C]	Correction factor
5 to 30	1.41
35	1.21
40	1
45	0.92
50	0.75
55	0.63
60	0.53

**IDF370D**

Inlet air temp. [°C]	Correction factor
5 to 30	1.25
35	1.00
40	0.83
45	0.70
50	0.60

**IDU Series**

**IDU3E to IDU37E**

Inlet air temp. [°C]	Correction factor
5 to 45	1.15
50	1.07
55	1
60	0.95
65	0.9
70	0.86
75	0.82
80	0.79

**IDU55E, 75E**

Inlet air temp. [°C]	Correction factor
5 to 45	1.21
50	1.10
55	1
60	0.87
65	0.76
70	0.74
75	0.72
80	0.70

**Data (B): Ambient Temperature \*1**

**IDF Series**

**IDF1E to 15E1**

Ambient temp. [°C]	Correction factor
2 to 25	1.14
30	1.04
32	1
35	0.96
40	0.9

**IDF100F to 150F**

Ambient temp. [°C]	Correction factor
2 to 25	1.06
30	1.02
32	1
35	0.99
40	0.98
45	0.92

**IDF190D to 240D**

Ambient temp. [°C]	Correction factor
2 to 25	1.10
30	1.05
32	1
35	0.95
40	0.90

**IDU Series**

**IDU3E to IDU37E**

Ambient temp. [°C]	Correction factor
2 to 25	1.2
30	1.04
32	1
35	0.93
40	0.84

**IDU55E, 75E**

Ambient temp. [°C]	Correction factor
2 to 25	1.25
30	1.11
32	1
35	0.90
40	0.63

\*1 For the water-cooled type, the correction factor is determined to "1" in an ambient temperature range of 2 to 45°C.

**Data (C): Outlet Air Pressure Dew Point**

**IDF Series**

**IDF1E to 15E1, IDU3E to IDU37E 190D to 370D**

Outlet air pressure dew point [°C]	Correction factor	Outlet air pressure dew point [°C]	Correction factor
3	0.55	3	0.55
5	0.7	5	0.7
10	1	10	1
15	1.3	15	1.3

**IDF100F to 150F**

Outlet air pressure dew point [°C]	Correction factor	Outlet air pressure dew point [°C]	Correction factor
3	0.55	3	0.53
5	0.7	5	0.67
10	1	10	1
15	1.4	15	1.30

**Data (D): Inlet Air Pressure**

**IDF Series**

**IDF1E to 15E1 IDF100F to 150F IDF190D to 370D**

Inlet air pressure [MPa]	Correction factor	Inlet air pressure [MPa]	Correction factor	Inlet air pressure [MPa]	Correction factor
0.2	0.62	0.2	0.84	0.2	0.68
0.3	0.72	0.3	0.87	0.3	0.77
0.4	0.81	0.4	0.9	0.4	0.84
0.5	0.88	0.5	0.93	0.5	0.90
0.6	0.95	0.6	0.96	0.6	0.95
0.7	1	0.7	1	0.7	1
0.8	1.06	0.8	1.03	0.8	1.03
0.9	1.11	0.9	1.06	0.9	1.06
1 to 1.6	1.16	1 to 1.6	1.09	1.0	1.08

**IDU Series**

**IDU3E to 37E IDU55E, 75E**

Inlet air pressure [MPa]	Correction factor	Inlet air pressure [MPa]	Correction factor
0.2	0.62	0.2	0.62
0.3	0.72	0.3	0.69
0.4	0.81	0.4	0.77
0.5	0.88	0.5	0.85
0.6	0.95	0.6	0.93
0.7	1	0.7	1
0.8	1.06	0.8	1.08
0.9	1.11	0.9	1.16
1 to 1.6	1.16	1 to 1.6	1.23

**Data (E): Air Flow Capacity**

**IDF Series**

Model	IDF1E	IDF2E	IDF3E	IDF4E	IDF6E	IDF8E	IDF11E	IDF15E1
Air flow capacity [m <sup>3</sup> /min (ANR)]	50 Hz 0.10	0.20	0.32	0.52	0.75	1.22	1.65	2.8
	60 Hz 0.12	0.235	0.37	0.57	0.82	1.32	1.82	3.1

Model	IDF100F	IDF125F	IDF150F	IDF190D	IDF240D	IDF370D
Air flow capacity [m <sup>3</sup> /min (ANR)]	50 Hz 16.0	20.1	25.0	32.0	43.0	54.0
	60 Hz 18.8	23.7	30.0	38.0	50.0	65.0

\* In the case of the Option A (cool compressed air output), the air flow capacity is different. Refer to page 61 for details.

**IDU Series**

Model	IDU3E	IDU4E	IDU6E	IDU8E	IDU11E	IDU15E1	IDU22E	IDU37E	IDU55E	IDU75E
Air flow capacity [m <sup>3</sup> /min (ANR)]	50 Hz 0.32	0.52	0.75	1.1	1.5	2.6	3.9	5.7	8.4	11.0
	60 Hz 0.37	0.57	0.82	1.2	1.7	2.8	4.3	6.1	9.8	12.5

# Refrigerant R134a (HFC) Standard Inlet Air Temperature

## IDF□E Series

1E, 2E, 3E, 4E, 6E, 8E, 11E, 15E1

(Max. inlet air temperature: 50°C, Max. ambient temperature: 40°C)

### How to Order

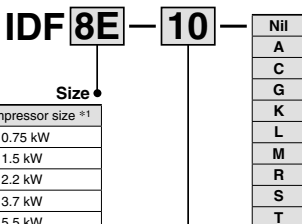

Symbol	Air compressor size *1
1E	0.75 kW
2E	1.5 kW
3E	2.2 kW
4E	3.7 kW
6E	5.5 kW
8E	7.5 kW
11E	11 kW
15E1	15 kW

\*1 Note that the above values are for reference only. Check the actual compressor capacity.

Symbol	Voltage	Applicable size							
		1E	2E	3E	4E	6E	8E	11E	15E1
10	Single-phase 100 VAC (50Hz) 100/110 VAC (60Hz)	●	●	●	●	●	●	●	●
	Single-phase 200 VAC (50Hz) 200/220 VAC (60Hz)	—	—	●	●	●	●	●	●

Symbol *1	Options									
	Nil	A	C	G	K	L	M	R	S	T
Description	None	Cool compressed air output	Ani-corrosive treatment for copper tube	With Chinese labels and a Chinese operation manual	Moderate pressure specification *2 (Auto drain bowl. Metal bowl with level gauge)	With a heavy-duty auto drain (applicable to moderate pressure) *2	With a motor type auto drain	With an earth leakage breaker	Power supply terminal block connection (Voltage symbol 10 only) *3	With a terminal block for power supply, operating, and error signals *4
Size	None	Cool compressed air output	Ani-corrosive treatment for copper tube	With Chinese labels and a Chinese operation manual	Moderate pressure specification *2 (Auto drain bowl. Metal bowl with level gauge)	With a heavy-duty auto drain (applicable to moderate pressure) *2	With a motor type auto drain	With an earth leakage breaker	Power supply terminal block connection (Voltage symbol 10 only) *3	With a terminal block for power supply, operating, and error signals *4
1E	●	●	●	●	—	—	—	—	●	— *5
2E	●	●	●	●	—	—	—	—	●	— *5
3E	●	●	●	●	—	—	—	—	●	— *5
4E	●	●	●	●	—	●	●	●	●	●
6E	●	●	●	●	●	●	●	●	●	●
8E	●	●	●	●	●	●	●	●	●	●
11E	●	●	●	●	●	●	●	●	●	●
15E1	●	●	●	●	●	●	●	●	●	●

\*1 When multiple options are combined, indicate symbols in alphabetical order.

However, the following combinations are not possible.

· R and S (Because S function is also included in R.)

· S and T (Because S function is also included in T.)

· The combination of K, L and M is not possible because an auto drain can only be attached to a single option.

\*2 The maximum operating pressure is 1.6 MPa.

\*3 Voltage symbol 20 (200 VAC) is the terminal block connection as standard. The Option S cannot be chosen.

· Voltage symbol 10 (100 VAC) is the power cable with plug as standard.

\*4 To users who are considering switching from the previous air dryer:

**When switching from the previous air dryer and remote operation are required, select the Made to Order (IDF□E□-X256) product.**

\*5 If a product with a terminal block for power supply, operating, and error signals is required, select the special order IDF□E□-X128.

\* Refer to pages 61 to 65 for further information on options.

## Standard Specifications

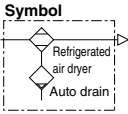

Specifications	Model	Standard inlet air temperature								
		IDF1E	IDF2E	IDF3E	IDF4E	IDF6E	IDF8E	IDF11E	IDF15E1	
<b>Fluid</b>		Compressed air								
<b>Inlet air temperature</b> [°C]		5 to 50								
<b>Inlet air pressure</b> [MPa]		0.15 to 1.0 *9								
<b>Ambient temperature (Humidity)</b> [°C]		2 to 40 (Relative humidity 85% or less)								
<b>Air flow capacity</b> [m³/min]	Standard condition (ANR) *1	50 Hz	0.10	0.20	0.32	0.52	0.75	1.22	1.65	2.8
		60 Hz	0.12	0.235	0.37	0.57	0.82	1.32	1.82	3.1
	Compressor intake condition *2	50 Hz	0.11	0.21	0.34	0.55	0.8	1.3	1.75	3.0
		60 Hz	0.13	0.25	0.39	0.61	0.87	1.4	1.93	3.3
<b>Inlet air pressure</b> [MPa]		0.7								
<b>Inlet air temperature</b> [°C]		35								
<b>Ambient temperature</b> [°C]		32								
<b>Outlet air pressure dew point</b> [°C]		10								
<b>Power supply voltage (Frequency)</b> *5		Single-phase: 100 VAC (50 Hz), 100/110 VAC (60 Hz) *5 Single-phase: 200 VAC (50 Hz), 200/220 VAC (60 Hz)								
<b>Electric specifications</b> *6	<b>Power consumption</b>	Single-phase 100 V	180/202	180/202	180/202	180/202	180/202	208/236	385/440	420/480
	50/60 Hz *15 [W]	Single-phase 200 V	—	—	—	—	—	—	—	—
	Operating current	Single-phase 100 V	2.4/2.5	2.4/2.5	2.4/2.5	2.4/2.5	2.4/2.5	3.0/3.1	5.7/5.7	4.3/4.6
	50/60 Hz *16 [A]	Single-phase 200 V	—	—	1.2/1.3	1.2/1.3	1.2/1.3	1.5/1.5	3.4/3.0	3.4/3.1
<b>Applicable earth leakage breaker capacity</b> *7		10 (100 VAC), 5 (200 VAC)								
(Sensitivity of leak current of 30 mA)		10 (100 VAC) 10 (200 VAC)								
<b>Condenser</b>		Air-cooled								
<b>Refrigerant</b>		R134a (HFC)								
<b>Refrigerant charge</b> [kg]		0.07	0.115	0.15	0.18	0.20	0.25	0.26	0.35	
<b>Auto drain</b>		Float type (Normally closed)		Float type (Normally open)						
<b>Port size</b>		Rc3/8		Rc1/2	Rc3/4		Rc1			
<b>Weight</b> [kg]		16	17	18	22	23	27	28	46	
<b>Applicable air compressor output (Reference) For screw type</b> [KW]		0.75	1.5	2.2	3.7	5.5	7.5	11	15	

- \*1 Air flow capacity under the standard condition (ANR) [20°C, Atmospheric pressure, and 65% Relative humidity]
- \*2 Air flow capacity converted by the compressor intake condition [32°C, Atmospheric pressure, and 75% Relative humidity]
- \*3 The operation range does not guarantee the use with normal air flow capacity.
- \*4 Select the model in accordance with Model Selection (pages 40, 41) for models beyond the rated specifications.
- \*5 When selecting a power supply voltage, refer to the How to Order on page 42.
- \*6 These values are reference values under rated conditions, and are not guaranteed. Do not use these values for the thermal set values, etc.
- \*7 Product other than the Option R is not equipped with an earth leakage breaker. Purchase an appropriate earth leakage breaker separately.

### Replacement Parts

Model	IDF1E	IDF2E	IDF3E	IDF4E	IDF6E	IDF8E	IDF11E	IDF15E1
Auto drain	New	AD37-A	AD38-A		AD48-A			
replacement parts no. *8	Previous	AD37	AD38		AD48			

- \*8 The part number for the auto drain (Bowl assembly) components only excluding the body part. Body part replacement is not possible. In addition, a new line of auto drain models was recently introduced in March 2019. The previous models and the new models do not have mounting interchangeability. For details, refer to page 76.
- \*9 The maximum operating pressure is 1.0 MPa as standard, but it is possible to achieve 1.6 MPa when selecting Option K or Option L.

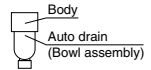

## Construction (Air/Refrigerant Circuit)

Humid, hot air coming into the air dryer will be cooled down by a cooler (heat exchanger). Water condensed at this time will be removed from the air by a drain separator (auto drain) and drained out automatically. Air separated from the water will be heated by a re-heater (heat exchanger) to obtain the dried air, which goes through to the outlet side.

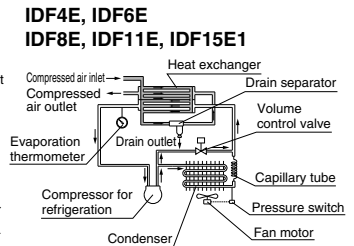
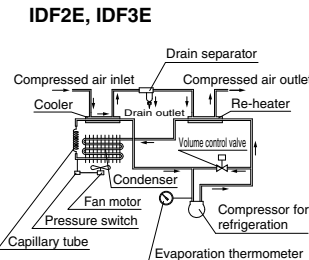
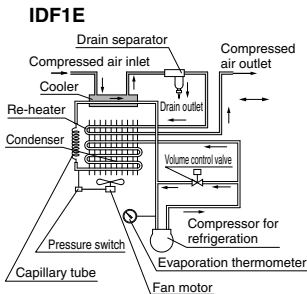

## Dimensions

### IDF1E to 3E

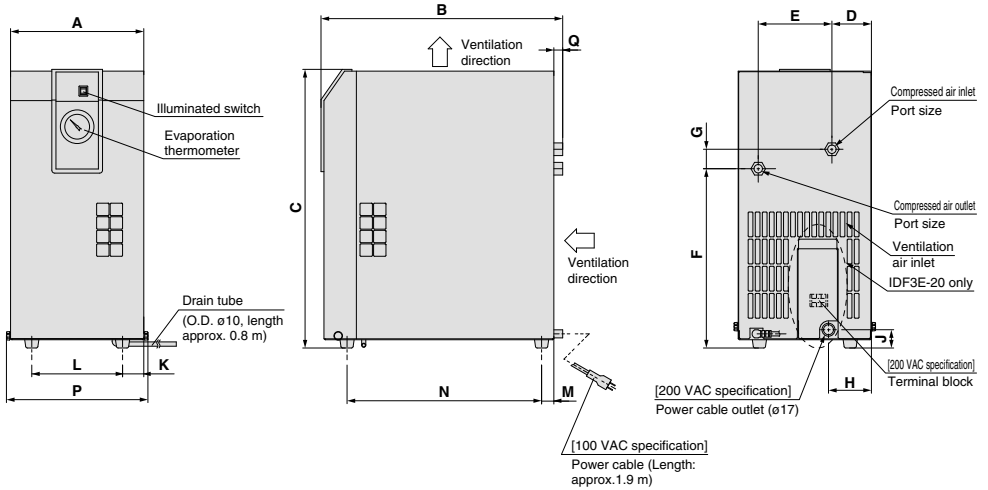

### IDF4E to 11E

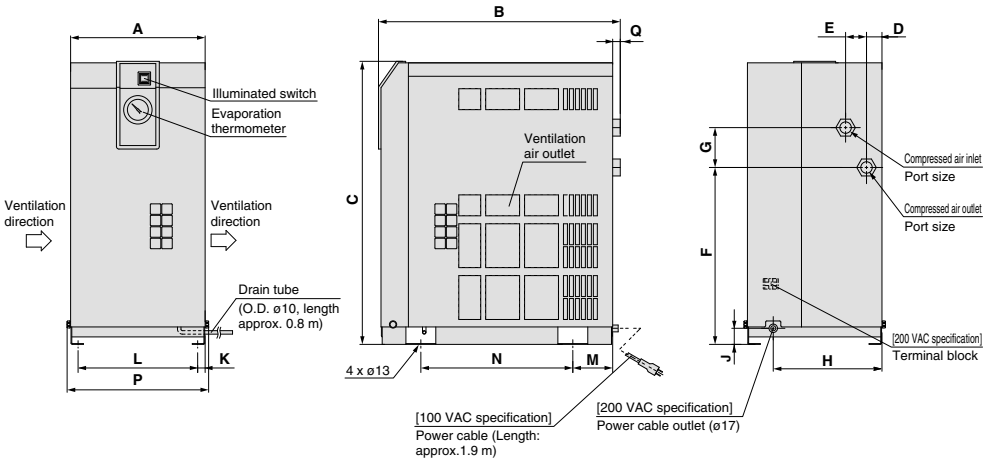

## Dimensions

Model	Port size	A	B	C	D	E	F	G	H	J	K	L	M	N	P	Q	
IDF1E	Rc3/8	226	410	413	69	101	270	32	—	—	38	150	21	330	240	15	
IDF2E				51	232	138	—	—	—	—	—	—	—	24			327
IDF3E				473	67	125	304	33	73	31	36	154	21	330			
IDF4E	Rc1/2	270	453	498	31	42	283	80	230	32	15	240	80	275	284	13	
IDF6E			455													300	15
IDF8E	Rc3/4	485	568	355	355	355	355	355	355	355	355	355	355	355	355	355	15
IDF11E																	300

**Dimensions**

**IDF15E1**

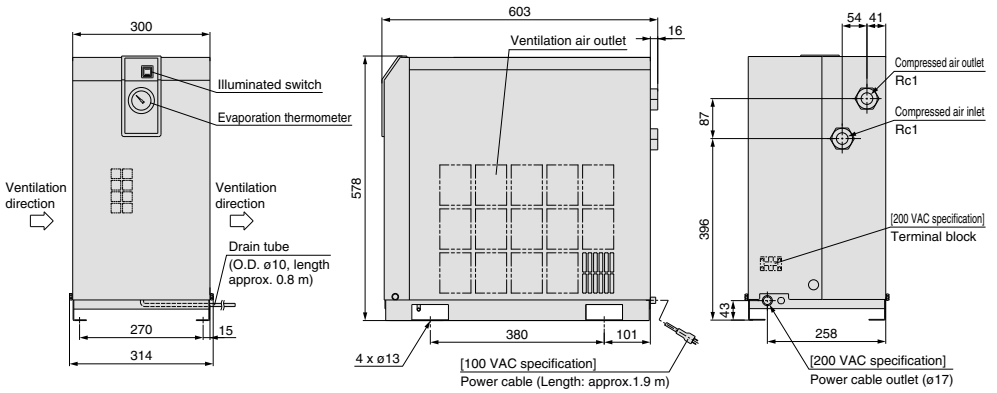

# Refrigerant R407C (HFC) Standard Inlet Air Temperature

## **IDF□E Series**

**22E, 37E, 55E, 75E**

(Inlet air temperature: 35°C (22E, 37E), 40°C (55E, 75E),  
Outlet air pressure dew point: 10°C)

The production of the IDF22E to 75E series has been discontinued.

Discontinued products	IDF22E	IDF37E	IDF55E	IDF75E
-----------------------	--------	--------	--------	--------

New type p. 81	IDF60	IDF60 or IDF70	IDF80	IDF80 or IDF90
-------------------	-------	----------------------	-------	----------------------

## Applicable for the high-temperature environments



Ambient temperature : Max. 45°C  
Inlet air temperature : Max. 65°C

### Air flow capacity

\* IDF90-20, Dew point of 10°C, 60 Hz

**16.4 m<sup>3</sup>/min**

(24% increase compared to the existing model)



# Refrigerant R407C (HFC)

# IDF100F/125F/150F Series

Applicable Compressor Size: 100 kW, 125 kW, 150 kW  
(Max. inlet air temperature: 60°C, Max. ambient temperature: 45°C)

## How to Order

### Air-cooled IDF 100F - 30 -

Size	Air compressor size *1
100F	100 kW
125F	125 kW
150F	150 kW

\*1 Note that the above values are for reference only. Check the actual compressor capacity.

Symbol	Voltage
30	Three-phase 200 VAC (50 Hz) 200/220 VAC (60 Hz)

Symbol *1	Description
Nil	None
C	Anti-corrosive treatment for copper tube
G	With Chinese labels and a Chinese operation manual
K	Moderate pressure specification (Up to 1.6 MPa)
P	With a metal name plate
R	With an earth leakage breaker
V	With a timer controlled solenoid valve type auto drain

- \*1 When multiple options are combined, indicate symbols in alphabetical order.
- \* A terminal block for remote operation, stop, operating, and error signals is included as standard equipment.
- \* Refer to pages 61 to 66 for further information on options.

Nil	Nil
C	1
G	2
K	3
P	
R	
V	

#### Heat exhausting direction

Symbol	Description
Nil	Heat exhaust from the rear
1	Heat exhaust from the right *1
2	Heat exhaust from the left *1
3	Heat exhaust from the top *1

\*1 The combination of 1, 2 and 3 is not available. (Heat exhausting face can be specified on one side only.)

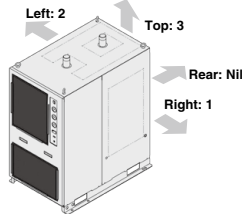

### Water-cooled IDF 100F - 30 -

Size	Air compressor size *1
100F	100 kW
125F	125 kW
150F	150 kW

\*1 Note that the above values are for reference only. Check the actual compressor capacity.

Symbol	Voltage
30	Three-phase 200 VAC (50 Hz) 200/220 VAC (60 Hz)

Symbol *1	Description
Nil	None
C	Anti-corrosive treatment for copper tube
G	With Chinese labels and a Chinese operation manual
K	Moderate pressure specification (Up to 1.6 MPa)
P	With a metal name plate
R	With an earth leakage breaker
V	With a timer controlled solenoid valve type auto drain

- \*1 Enter alphabetically when multiple options are combined.
- \* A terminal block for remote operation, stop, operating, and error signals is included as standard equipment.
- \* Refer to pages 61 to 66 for further information on options.

Nil	W
C	4
G	5
K	
P	
R	
V	

#### Piping direction

Symbol	Description
4	Facility water piping direction: Right *1
5	Facility water piping direction: Left *1

\*1 The combination of 4 and 5 is not available. (Piping direction can be specified on one side only.)

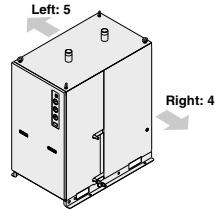

#### Cooling method

Symbol	Cooling method
W	Water-cooled condenser



# IDF100F/125F/150F Series

## Standard Specifications: Air-cooled Type



Specifications		Model	IDF100F-30	IDF125F-30	IDF150F-30	
Operating range <sup>①</sup>	Fluid		Compressed air			
	Inlet air temperature	[°C]	5 to 60			
	Inlet air pressure	[MPa]	0.15 to 1.0 <sup>*8</sup>			
	Ambient temperature (Humidity)	[°C]	2 to 45 (Relative humidity 85% or less)			
Rated conditions <sup>②-④</sup>	Air flow capacity [m³/min]	Standard condition	50 Hz	16	20.1	25
		(ANR) <sup>*1</sup>	60 Hz	18.8	23.7	30
	Compressor intake condition <sup>*2</sup>	50 Hz	17	21	27	
		60 Hz	20	25	32	
	Inlet air pressure	[MPa]	0.7			
	Inlet air temperature	[°C]	40			
	Ambient temperature	[°C]	32			
	Outlet air pressure dew point	[°C]	10			
	Exhaust heat from condenser (50/60 Hz)	[kW]	8.0/9.0	10.0/11.5	12.0/15.0	
	Air dryer outlet air temperature	[°C]	37			
Power supply voltage (Frequency)		Three-phase 200 VAC (50 Hz), 200/220 VAC (60 Hz)				
Basic specifications	Power consumption [kW] 50/60 Hz <sup>*5</sup>		2.9/3.5	4.0/4.7	4.0/4.8	
	Operating current <sup>*5</sup> [A] 50/60 Hz		10.5/11.5	15.4/15.6	15.7/16.0	
	Applicable earth leakage capacity <sup>*6</sup> (Sensitivity of leak current of 30 mA) [A]		30			
Refrigerant		R407C (HFC)				
Refrigerant charge	[kg]	1.1	1.6	1.98		
Auto drain		Heavy-duty auto drain (Normally open)				
Port size		R2	JIS Flange 65A 10K	JIS Flange 80A 10K		
Weight	[kg]	245	270	350		
Applicable air compressor output (Reference) For screw type	[kW]	100	125	150		

- \*1 Air flow capacity under the standard condition (ANR) [20°C, Atmospheric pressure, and 65% Relative humidity]
- \*2 Air flow capacity converted by the compressor intake condition [32°C, Atmospheric pressure, relative humidity 75%]
- \*3 The operation range does not guarantee the use with normal air flow capacity.
- \*4 Select the unit in accordance with Model Selection (pages 40, 41) for models beyond the rated specifications.
- \*5 These values are reference values under rated conditions, and are not guaranteed. Do not use these values for the thermal set values, etc.
- \*6 Product other than the Option R is not equipped with an earth leakage breaker. Purchase an appropriate earth leakage breaker separately.

### Replacement Parts

Air dryer model	IDF100F	IDF125F	IDF150F
Heavy-duty auto drain replacement part no. <sup>*7</sup>	ADH-E400		
Dustproof filter set for condenser	IDF-FL219	IDF-FL220	

- \*7 Part number of only the exhaust mechanism replacement kit excluding the housing
- \*8 The maximum operating pressure is 1.0 MPa as standard, but it is possible to achieve 1.6 MPa when selecting Option K.
- \* A terminal block for remote operation, stop, operating, and error signal is included as standard equipment.

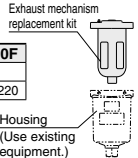

### Symbol

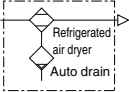

## Construction (Air/Refrigerant Circuit)

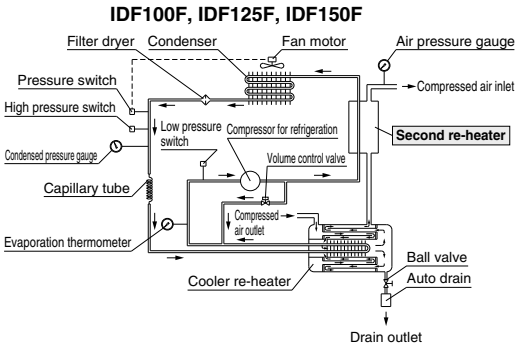

Hot and humid air entering the air dryer is cooled down by the cooler re-heater (heat exchanger). The moisture which is condensed and separated is automatically exhausted by the auto drain. The air which has had its moisture removed is heated in two stages by the re-heater (heat exchanger) in the cooler re-heater and by the second re-heater, and is supplied to the outlet side as warm and dry air.

### Second re-heater

Compressed air from which drainage has been exhausted exchanges heat with refrigerant which has been compressed by the compressor for refrigeration, to give the following effects:

1. The outlet air temperature increases, preventing condensation of the piping on the outlet side.
2. The amount of heat exhausted from the condenser is reduced.
3. Energy saving operation of the air dryer is achieved by reducing the amount of heat exhausted from the condenser.



# Refrigerated Air Dryer **IDF100F/125F/150F Series**

## Standard Specifications: Water-cooled Type



### Symbol

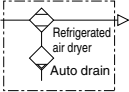

Specifications	Model	IDF100F-30-W	IDF125F-30-W	IDF150F-30-W	
Operating range <sup>1)</sup>	Fluid	Compressed air			
	Inlet air temperature [°C]	5 to 60			
	Inlet air pressure [MPa]	0.15 to 1.0 *10			
	Ambient temperature (Humidity) [°C]	2 to 45 (Relative humidity 85% or less)			
Rated conditions	Air flow capacity [m <sup>3</sup> /min]	Standard condition 50 Hz	16	20.1	25
		(ANR) <sup>4)</sup> 60 Hz	18.8	23.7	30
	Compressor intake condition <sup>12)</sup>	50 Hz	17	21	27
		60 Hz	20	25	32
	Inlet air pressure [MPa]	0.7			
	Inlet air temperature [°C]	40			
	Ambient temperature [°C]	32			
	Outlet air pressure dew point [°C]	10			
	Air dryer outlet air temperature [°C]	37			
	Facility water flow rate <sup>14)</sup> (50/60 Hz) [m <sup>3</sup> /h]	1.29/1.56	1.74/1.98	2.16/2.52	
Facility water inlet temperature [°C]	32				
Facility water pressure drop <sup>15)</sup> (50/60 Hz) [MPa]	0.07/0.1				
Cooling tower capacity <sup>16)</sup> [kW(RT)]	9 (2)	11.5 (2.5)	14.5 (3.2)		
Recommended chiller model <sup>16)</sup> (made by SMC)	HRS100-A		HRS150-A		
Electric specifications	Power supply voltage (Frequency)	Three-phase 200 VAC (50 Hz), 200/220 VAC (60 Hz)			
	Power consumption [kW] 50/60 Hz <sup>17)</sup>	2.4/2.8	2.4/2.8	2.8/3.3	
	Operating current [A] 50/60 Hz <sup>17)</sup>	8.5/9.0	8.5/9.0	10.2/11.5	
Facility water pressure range [MPa]	0.2 to 0.98				
Required facility water flow rate (50/60 Hz) [m <sup>3</sup> /h]	1.29/1.56	1.74/1.98	2.16/2.52		
Facility water inlet temperature range [°C]	5 to 40				
Facility water port size	R1/2		R3/4		
Facility water amount adjusting equipment	Pressure type water regulating valve				
Condenser	Plate type				
Applicable earth leakage capacity <sup>18)</sup> (Sensitivity of leak current of 30 mA) [A]	20		30		
Refrigerant	R407C (HFC)				
Refrigerant charge [kg]	0.9	1.2	1.5		
Auto drain	Heavy-duty auto drain (Normally open)				
Port size	R2	JIS Flange 65A 10K	JIS Flange 80A 10K		
Weight [kg]	226	250	322		
Applicable air compressor output (Reference) For screw type [kW]	100	125	150		

- \*1 Air flow capacity under the standard condition (ANR) [20°C, Atmospheric pressure, and 65% Relative humidity]
- \*2 Air flow capacity converted by the compressor intake condition [32°C, Atmospheric pressure, relative humidity 75%]
- \*3 The operation range does not guarantee the use with normal air flow capacity. Select the model in accordance with Model Selection (pages 40, 41) for models beyond the rated specifications.
- \*4 The facility water flow rate that satisfies the rated conditions with a facility water inlet temperature of 32°C and an output temperature of 37°C ( $\Delta T = 5^\circ\text{C}$ )
- \*5 These values are obtained under rated conditions with a rated facility water flow rate and a facility water inlet pressure of 0.2 MPa.
- \*6 These values are obtained under rated conditions (1 RT = 4.535 kW).
- \*7 These values are reference values under rated conditions, and are not guaranteed. Do not use these values for the thermal set values, etc.
- \*8 Product other than the Option R is not equipped with an earth leakage breaker.
- \*9 Purchase an appropriate earth leakage breaker separately.

### Replacement Parts

Air dryer model	IDF100F-W	IDF125F-W	IDF150F-W
Heavy-duty auto drain replacement part no. <sup>9)</sup>	ADH-E400		
Facility water piping strainer	IDF-S0406	IDF-S0418	

\*9 Part number of only the exhaust mechanism replacement kit excluding the housing

\*10 The maximum operating pressure is 1.0 MPa as standard, but it is possible to achieve 1.6 MPa when selecting Option K.

\* A terminal block for remote operation, stop, operating, and error signal is included as standard equipment.

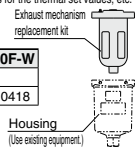

## Construction (Air/Refrigerant Circuit)

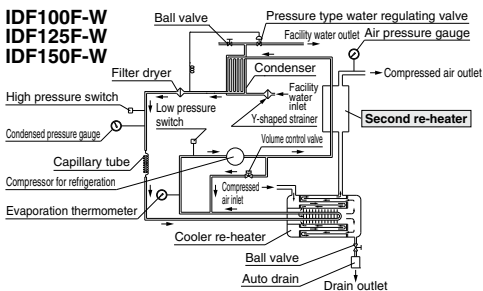

Hot and humid air entering the air dryer is cooled down by the cooler re-heater (heat exchanger). The moisture which is condensed and separated is automatically exhausted by the auto drain. The air which has had its moisture removed is heated in two stages by the re-heater (heat exchanger) in the cooler re-heater and by the second re-heater, and is supplied to the outlet side as warm and dry air.

### Second re-heater

Compressed air from which drainage has been exhausted exchanges heat with refrigerant which has been compressed by the compressor for refrigeration, to give the following effects:

1. The outlet air temperature increases, preventing condensation of the piping on the outlet side.
2. The amount of heat exhausted from the condenser is reduced.
3. Energy saving operation of the air dryer is achieved by reducing the amount of heat exhausted from the condenser.

# IDF100F/125F/150F Series

## Dimensions

### IDF100F: Air-cooled type

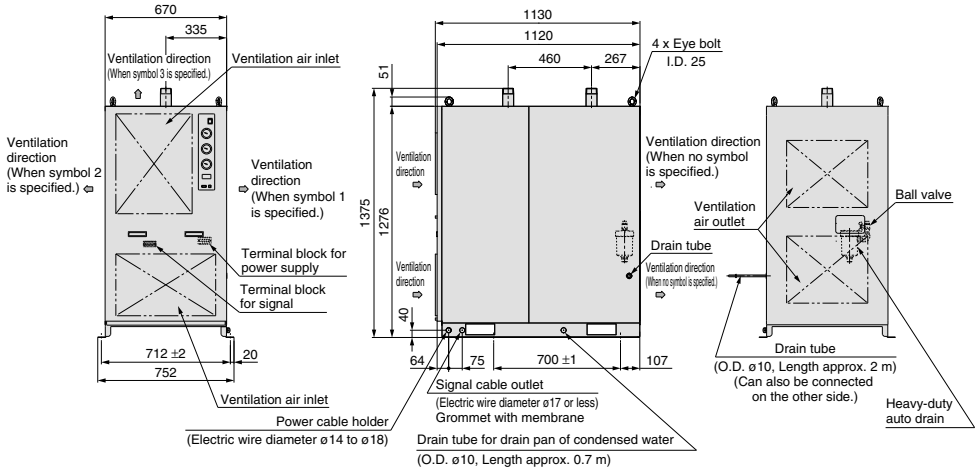

### IDF100F-W: Water-cooled type

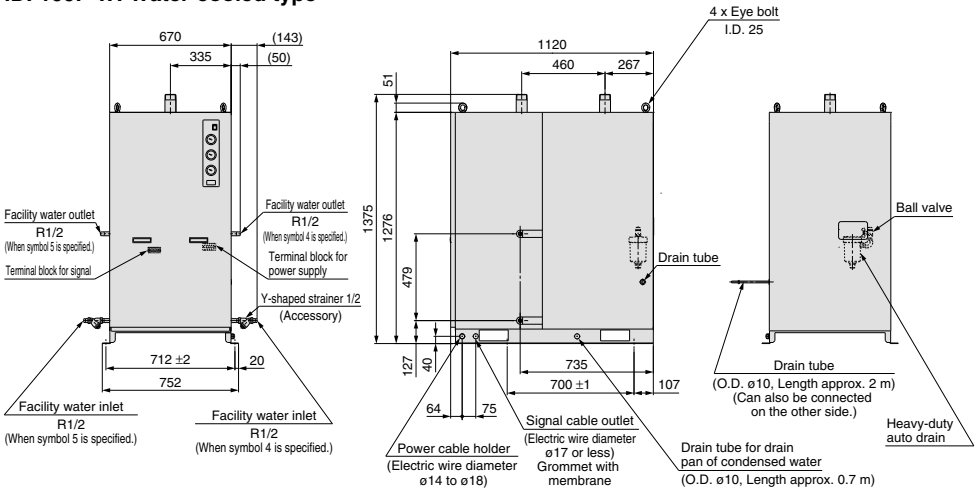

Top view (Air-cooled/Water-cooled)

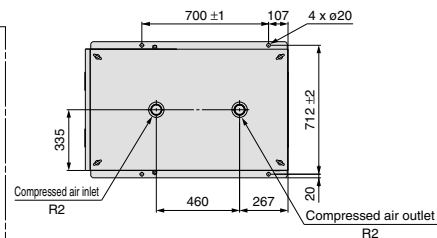
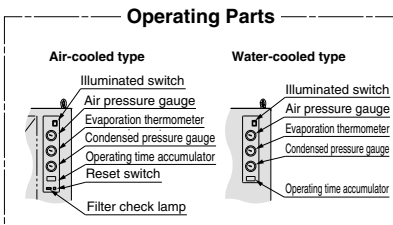

## Dimensions

### IDF125F/150F: Air-cooled type

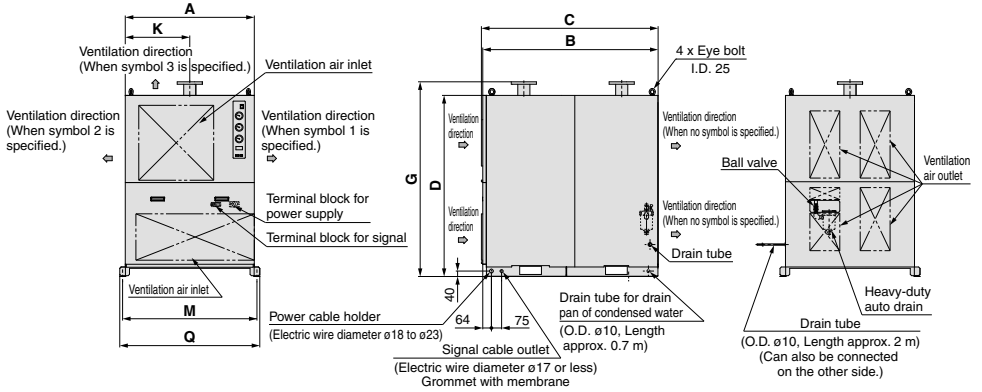

### IDF125F-W/150F-W: Water-cooled type

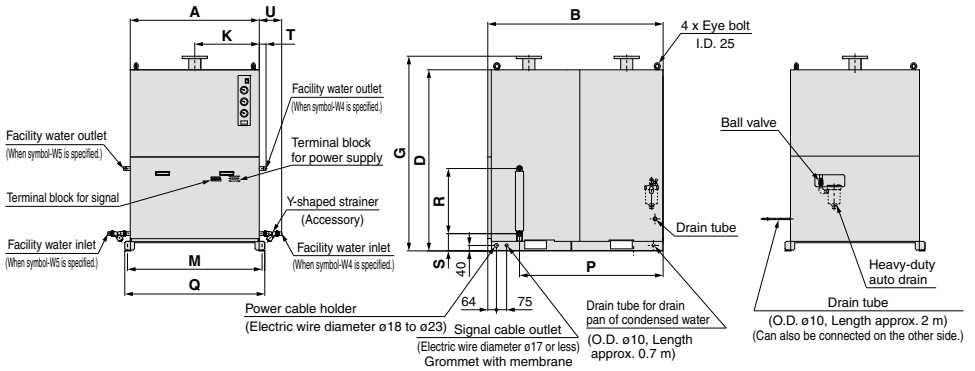

### Operating Parts

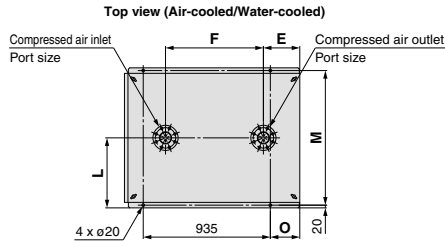
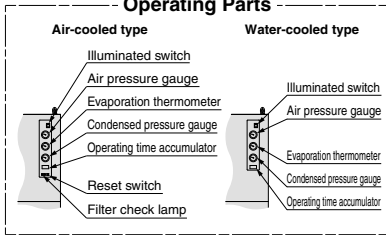

### Dimensions

Model	Port size	A	B	C	D	E	F	G	K	L	M	O	P	Q	R	S	T	U	Facility water inlet/outlet
<b>IDF125F</b>	JIS Flange 65A 10K	700	1120	1130	1276	267	655	1375	350	376	712	78	—	752	—	—	—	—	—
<b>IDF125F-W</b>	JIS Flange 65A 10K	700	1120	1130	1276	267	655	1375	350	376	712	78	885	752	479	127	36	129	R1/2
<b>IDF150F</b>	JIS Flange 80A 10K	950	1290	1300	1332	268	720	1432	475	515	990	217	—	1030	—	—	—	—	—
<b>IDF150F-W</b>	JIS Flange 80A 10K	950	1290	1300	1332	268	720	1432	475	515	990	217	1056	1030	479	127	50	165	R3/4

# Refrigerant R407C (HFC) Standard Inlet Air Temperature

## IDF □ D Series

190D, 240D, 370D

(Inlet air temperature: 40°C (190D, 240D), 35°C (370D),

Outlet air pressure dew point: 10°C)

### How to Order

Refrigerant R407C

IDF190D to IDF370D

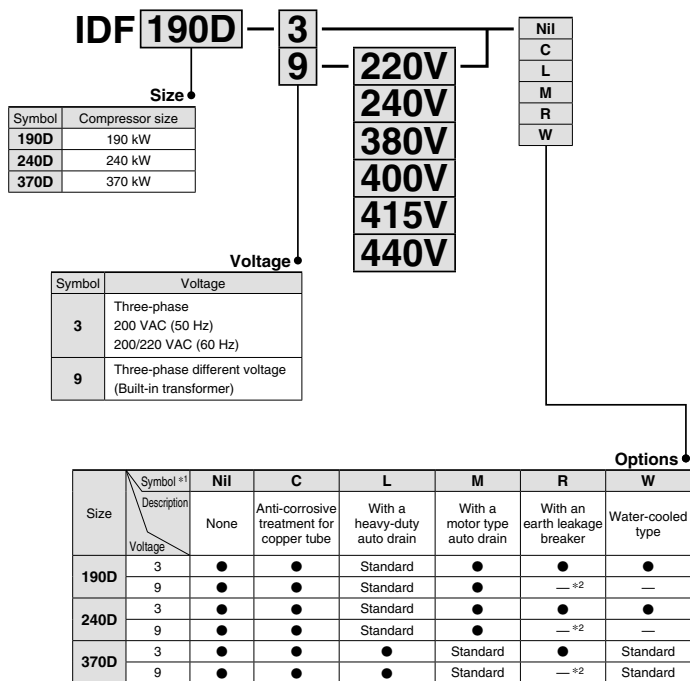

\*1 When multiple options are combined, indicate symbols in alphabetical order.

\*2 Purchase an appropriate earth leakage breaker suitable for the inlet voltage separately.

\* Refer to pages 61 to 66 for further information on options.

\* The standard type (Nil) is equipped with a terminal block for remote operation, stop, operating, and error signals.

## Standard Specifications

Specifications	Model	Standard inlet air temperature			
		IDF190D	IDF240D	IDF370D	
<b>Fluid</b>		Compressed air			
<b>Inlet air temperature</b> [°C]		5 to 50			
<b>Inlet air pressure</b> [MPa]		0.15 to 0.97			
<b>Ambient temperature (Humidity)</b> [°C]		2 to 40 (Relative humidity 85% or less)		2 to 43 (Relative humidity 85% or less)	
<b>Operating range</b> <sup>※4</sup>	Standard condition	50 Hz	32	43	54
	(ANR) <sup>※1</sup>	60 Hz	38	50	65
	Compressor intake condition <sup>※2</sup>	50 Hz	34	46	57
		60 Hz	40	53	69
			0.7		
<b>Rated conditions</b> <sup>※4</sup>	<b>Air flow capacity</b> [m <sup>3</sup> /min]				
	<b>Inlet air pressure</b> [MPa]				
	<b>Inlet air temperature</b> [°C]		40		35
	<b>Ambient temperature</b> [°C]		32		—
	<b>Outlet air pressure dew point</b> [°C]		10		
<b>Power supply voltage (Frequency)</b> <sup>※5</sup>		Three-phase: 200 VAC (50 Hz), 200/220 VAC (60 Hz)		Three-phase: 200 VAC (50/60 Hz)	
<b>Energy specifications</b> <sup>※6</sup>	<b>Power consumption</b> 50/60 Hz <sup>※6</sup> [kW]	Three-phase 200 V	4.9	6.3	11.6
			5.9	7.6	11.6
	<b>Operating current</b> 50/60 Hz <sup>※6</sup> [A]	Three-phase 200 V	19.5	26.1	36.5
			20.1	26.4	36.5
<b>Applicable earth leakage capacity</b> <sup>※7</sup> (Sensitivity of leak current of 30 mA) [A]		50			
<b>Condenser</b>		Air-cooled		Water-cooled	
<b>Air re-heater/Air cooler</b>		Class 2 pressure vessel			
<b>Refrigerant</b>		R407C (HFC)			
<b>Refrigerant charge</b> [kg]		2.48	4.5	11.0	
<b>Auto drain</b>		ADH4000-04		ADM200-042-8	
<b>Port size</b> <sup>※8</sup>		80 (3B) Flange	100 (4B) Flange	150 (6B) Flange	
<b>Weight</b> [kg]		450	660	1100	
<b>Applicable air compressor output (Reference) For screw type</b> [kW]		190	240	370	

- \*1 Air flow capacity under the standard condition (ANR) [20°C, Atmospheric pressure, and 65% Relative humidity]
- \*2 Air flow capacity converted by the compressor intake condition [32°C, Atmospheric pressure, and 75% Relative humidity]
- \*3 The operation range does not guarantee the use with normal air flow capacity.
- \*4 Select the model in accordance with Model Selection (pages 40, 41) for models beyond the rated specifications.
- \*5 When selecting a power supply voltage, refer to the How to Order on page 52.
- \*6 These values are reference values under rated conditions, and are not guaranteed. Do not use these values for the thermal set values, etc.
- \*7 Product other than the Option R is not equipped with an earth leakage breaker. Purchase an appropriate earth leakage breaker separately.
- \*8 JIS 10K FF is used as a flange.

## Construction (Air/Refrigerant Circuit)

### IDF190D

### IDF240D

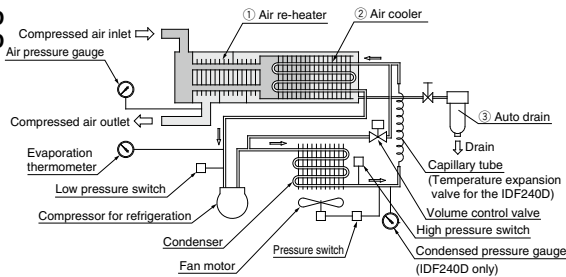

### IDF370D

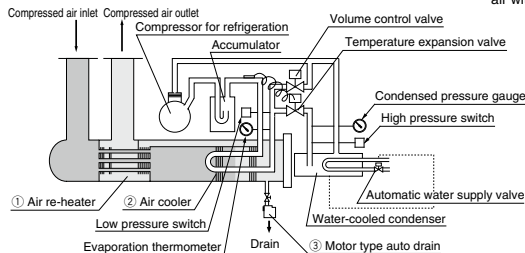

## Water-cooled Condenser (IDF370D)

Condenser	Shell and tube type
<b>Cooling water flow rate</b> <sup>※1</sup>	6 m <sup>3</sup> /h
<b>Cooling tower performance</b> <sup>※2</sup>	10 RT
<b>Water flow regulator</b>	Pressure type automatic water supply valve
<b>Port size for water side</b>	1 1/4 union

\*1 Value with rated load when cooling water inlet temperature is 32°C.

\*2 Calculated at 1 RT = 4,535 kW

## Motor Type Auto Drain

Model	Operating cycle
IDF370D	4 times per minute   for 8 seconds every one minute
<b>Power supply</b>	200 VAC 50/60 Hz
<b>Power consumption</b>	4 W

### Symbol

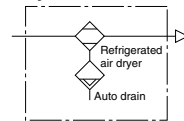

High temperature humid air from the air compressor passes through the air re-heater ① and is pre-cooled by dehumidified cool air. Then, it is cooled to the specified temperature by the air cooler ② using the evaporation heat of refrigerant.

At this time, the oil mist and moisture generated by condensation are automatically exhausted by the auto drain ③. The cooled and dehumidified air goes back to the air re-heater ① and heat is exchanged with hot air that flows into the air re-heater. It is supplied as dry warm air without "sweating" in the piping system.

# IDF□D Series

## Dimensions

### IDF190D, IDF240D

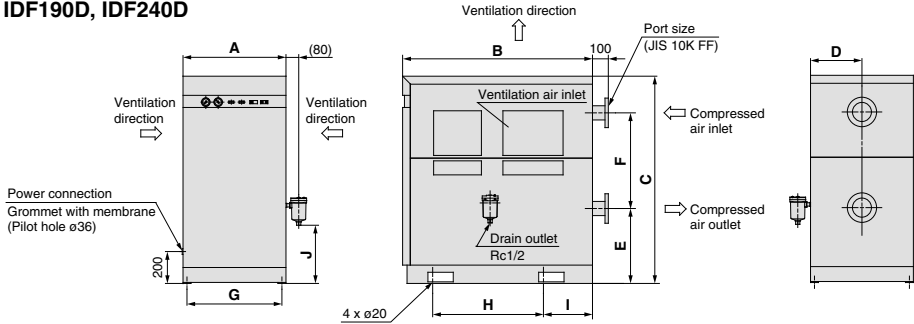

[mm]											
Model	Inlet and outlet port	A	B	C	D	E	F	G	H	J	
<b>IDF190D</b>	JIS 10K FF 80 (3B) Flange	750	1510	1320	375	480	600	700	800	355	427
<b>IDF240D</b>	JIS 10K FF 100 (4B) Flange	770	1550	1640	385	703	730	700	800	355	467

\* The auto drain is enclosed in the same shipping package as the main body. Customers are required to mount the auto drain to the air dryer.

### IDF370D

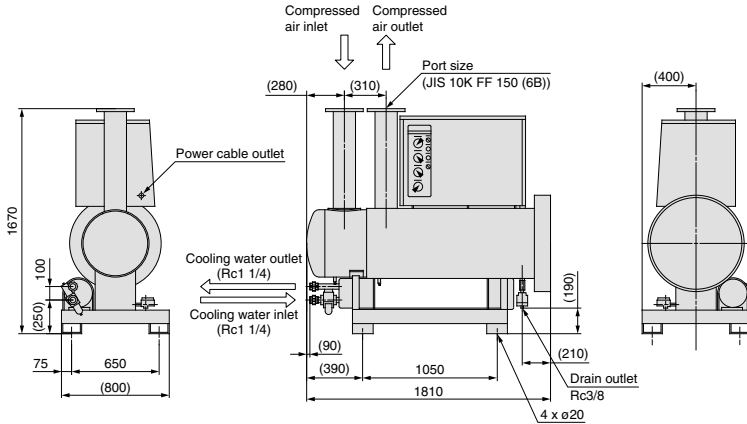

## Power Transformer Integrated Type

### IDF370D

The power transformer marked with the voltage symbol "9" is integrated into the refrigerated air dryer.

### IDF190D to 240D

The power transformer marked with the voltage symbol "9" is built into the main body, and the outside dimensions are the same as those with the voltage symbol "3."

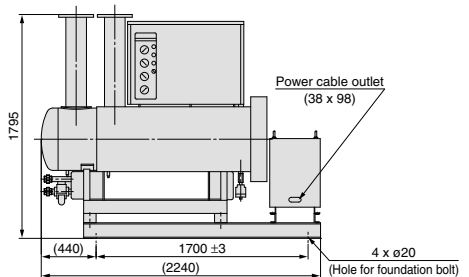

# Refrigerant R134a (HFC) High Inlet Air Temperature **IDU□E Series**

## 3E, 4E, 6E, 8E, 11E, 15E1

(Max. inlet air temperature: 80°C, Max. ambient temperature: 40°C)

### How to Order

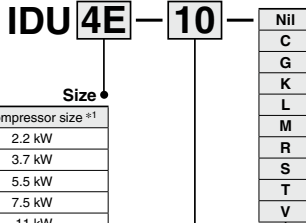

Size ●

Symbol	Air compressor size *1
3E	2.2 kW
4E	3.7 kW
6E	5.5 kW
8E	7.5 kW
11E	11 kW
15E1	15 kW

\*1 Note that the above values are for reference only. Check the actual compressor capacity.

Voltage ●

Symbol	Voltage	Applicable size					
		3E	4E	6E	8E	11E	15E1
10	Single-phase 100 VAC (50 Hz) 100/110 VAC (60 Hz)	●	●	●	●	●	●
	Single-phase 200 VAC (50 Hz) 200/220 VAC (60 Hz)	●	●	●	●	●	●
23	Single-phase 230 VAC (50 Hz)	●	●	●	●	●	●

Options ●

Symbol *1	Nil	C	G	K	L	M	R	S	T	V
	Description	None	Anti-corrosive treatment for copper tube	With Chinese labels and a Chinese operation manual	Moderate pressure specification *2 (Auto drain bowl; Metal) (bowl with level gauge)	With a heavy-duty auto drain (applicable to moderate pressure) *2	With a motor type auto drain (Voltage symbol 10, 20 only)	With an earth leakage breaker	Power supply terminal block connection (Voltage symbol 10 only) *2	With a terminal block for power supply, operating, and error signals
3E	●	●	●	●	●	●	●	●	●	●
4E	●	●	●	●	●	●	●	●	●	●
6E	●	●	●	●	●	●	●	●	●	●
8E	●	●	●	●	●	●	●	●	●	●
11E	●	●	●	●	●	●	●	●	●	●
15E1	●	●	●	●	●	●	●	●	●	●

\*1 When multiple options are combined, indicate symbols in alphabetical order. However, the following combinations are not possible.

- R and S (Because S function is also included in R.)
- S and T (Because S function is also included in T.)
- The combination of K, L, M and V is not possible because an auto drain can only be attached to a single option.

\*2 The maximum operating pressure is 1.6 MPa.

\*3 Voltage symbol 20 (200 VAC) and 23 (230 VAC) are the terminal block connection as standard. The Option S cannot be chosen. Voltage symbol 10 (100 VAC) is the power cable with plug as standard.

\*4 To users who are considering switching from the previous air dryer:

**When switching from the previous air dryer and remote operation are required, select the Made to Order (IDU□E□-X256) product.**

\* Refer to pages 61 to 65 for further information on options.

## Standard Specifications



### Symbol

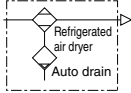

Specifications		Model							
		IDU3E	IDU4E	IDU6E	IDU8E	IDU11E	IDU15E1		
Operating range	Fluid	Compressed air							
	Inlet air temperature [°C]	5 to 80							
	Inlet air pressure [MPa]	0.15 to 1.0 <sup>#10</sup>							
	Ambient temperature (Humidity) [°C]	2 to 40 (Relative humidity 85% or less)							
Rated conditions <sup>#4</sup>	Air flow capacity [m <sup>3</sup> /min]	Standard condition	50 Hz	0.32	0.52	0.75	1.1	1.5	2.6
		(ANR) <sup>#1</sup>	60 Hz	0.37	0.57	0.82	1.2	1.7	2.8
	Compressor intake condition <sup>#2</sup>	50 Hz	0.34	0.55	0.8	1.2	1.6	2.8	
		60 Hz	0.39	0.61	0.87	1.3	1.8	3.0	
	Inlet air pressure [MPa]	0.7							
	Inlet air temperature [°C]	55							
	Ambient temperature [°C]	32							
	Outlet air pressure dew point [°C]	10							
	Power supply voltage (Frequency) <sup>#5</sup>	Single-phase: 100 VAC (50 Hz), 100/110 VAC (60 Hz) <sup>#5</sup> Single-phase: 200 VAC (50 Hz), 200/220 VAC (60 Hz) Single-phase: 230 VAC ±10% (50 Hz)							
	Electric specifications <sup>#4</sup>	Power consumption [W]	Single-phase 100 V	180/202	208/236	385/440	250/290 <sup>#7</sup>	425/470 <sup>#7</sup>	460/530 <sup>#7</sup>
50/60 Hz <sup>#6</sup>		Single-phase 200 V	210	220	400	260	425	450	
		Single-phase 230 V (50 Hz)	210	220	400	260	425	450	
Operating current [A]		100 V	2.4/2.5	3.0/3.1	5.7/5.7	3.4/3.5	5.7/6.0	4.6/4.9	
		200 V	1.2/1.3	1.5/1.5	3.4/3.0	1.7/1.7	3.5/3.2	3.6/3.4	
50/60 Hz <sup>#6</sup>	230 V (50 Hz)	1.5	1.6	2.9	1.7	3.0	3.2		
Applicable earth leakage breaker capacity <sup>#8</sup> (Sensitivity of leak current of 30 mA) [A]	10 (100 VAC), 5 (200 VAC, 230 VAC)						10 (100 VAC) 10 (200 VAC)		
Refrigerant	R134a (HFC)								
Refrigerant charge [kg]	Single-phase 100 V	0.2	0.25	0.26	0.28	0.29	0.35		
	Single-phase 200 V	0.2	0.25	0.26	0.28	0.29	0.35		
	Single-phase 230 V	0.23	0.27	0.29	0.28	0.29	0.35		
Auto drain	Float type (Normally open)								
Port size	Rc3/8	Rc1/2	Rc3/4	Rc1					
Weight [kg]	23	27	28	44	47	71			
Applicable air compressor output (Reference) For screw type [kW]	2.2	3.7	5.5	7.5	11	15			

- <sup>#1</sup> Air flow capacity under the standard condition (ANR) [20°C, Atmospheric pressure, and 65% Relative Humidity]
- <sup>#2</sup> Air flow capacity converted by the compressor intake condition [32°C, Atmospheric pressure, and 75% Relative Humidity]
- <sup>#3</sup> The operation range does not guarantee the use with normal air flow capacity.
- <sup>#4</sup> Select the model in accordance with Model Selection (pages 40, 41) for models beyond the rated specifications.
- <sup>#5</sup> When selecting a power supply voltage, refer to the How to Order on page 55.
- <sup>#6</sup> These values are reference values under rated conditions, and are not guaranteed. Do not use these values for the thermal set values, etc.
- <sup>#7</sup> For the IDU8E to 15E1, cooling with the aftercooler helps reduce power consumption by up to 50%.
- <sup>#8</sup> Product other than the Option R is not equipped with an earth leakage breaker. Purchase an appropriate earth leakage breaker separately.

### Replacement Parts

Model		IDU3E	IDU4E	IDU6E	IDU8E	IDU11E	IDU15E1
Auto drain replacement parts no. <sup>#9</sup>	New	AD48-A					
	Previous	AD48					

- <sup>#9</sup> The part number for the auto drain (Bowl assembly) components only excluding the body part. Body part replacement is not possible. In addition, a new line of auto drain models was recently introduced in March 2019. The previous models and the new models do not have mounting interchangeability. For details, refer to page 76.

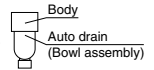

- <sup>#10</sup> The maximum operating pressure is 1.0 MPa as standard, but it is possible to achieve 1.6 MPa when selecting Option K, Option L, or Option V.

## Construction (Air/Refrigerant Circuit)

Humid, hot air coming into the air dryer will be cooled down by a heat exchanger. Water condensed at this time will be removed from the air by a drain separator and drained out automatically. Air separated from the water will be heated by a heat exchanger to obtain the dried air, which goes through to the outlet side. For models IDU8E to 15E1, the humid and hot air introduced to the air dryer will be cooled down by the aftercooler before being cooled down by the heat exchanger.

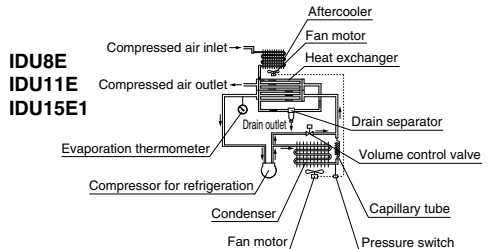
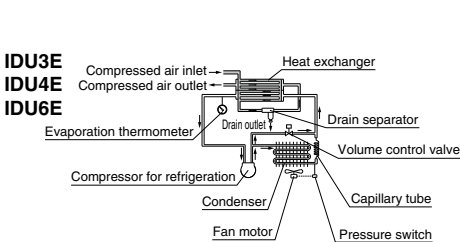



**Dimensions**

**IDU3E to IDU6E**

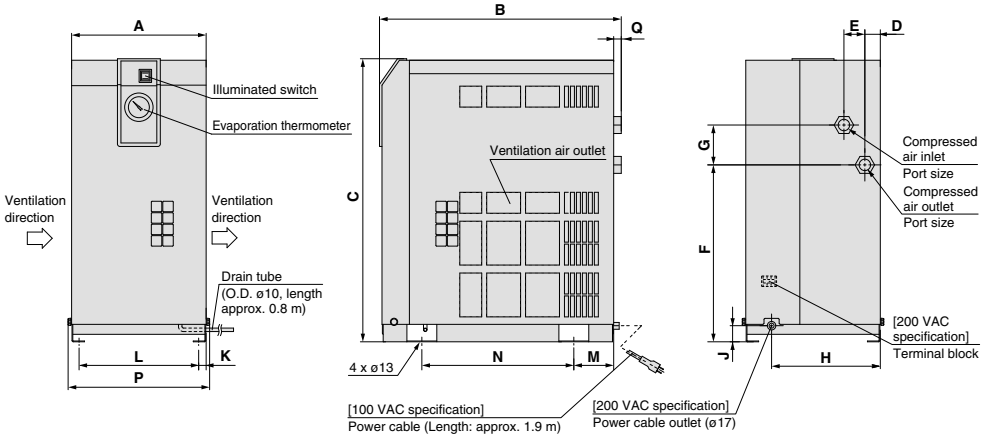

**Dimensions**

Model	Port size	A	B	C	D	E	F	G	H	J	K	L	M	N	P	Q
IDU3E	Rc3/8	270	455	498	31	42	283	80	230	32	15	240	80	300	284	15
IDU4E	Rc1/2		483	568			355									13
IDU6E	Rc3/4		485													15

**IDU8E to IDU15E1**

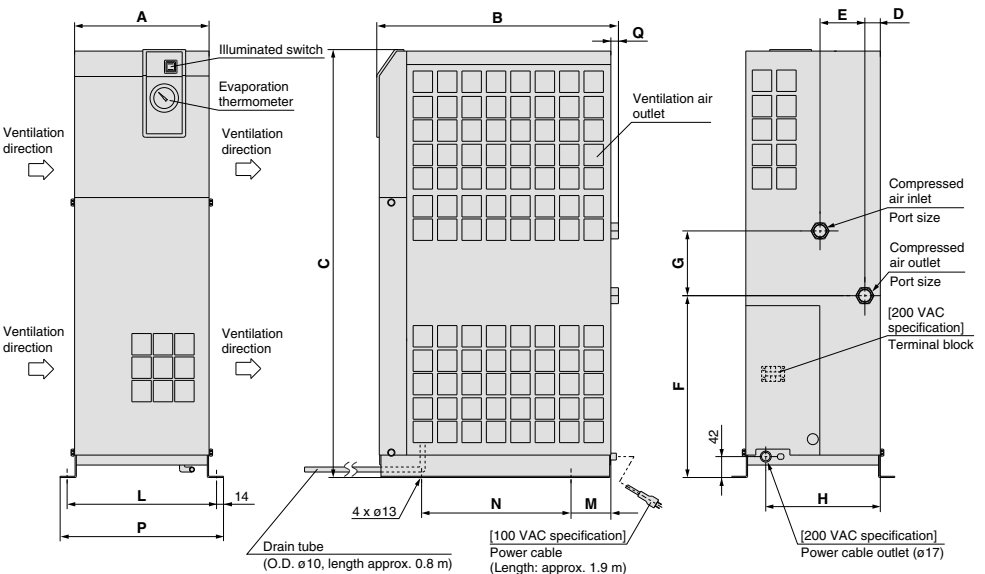

**Dimensions**

Model	Port size	A	B	C	D	E	F	G	H	L	M	N	P	Q
IDU8E	Rc3/4	270	485	859	31	90	365	130	230	300	80	300	328	15
IDU11E			909	425										
IDU15E1	Rc1	300	620	960	79	54	425	93	258	330	66	470	358	16

# Refrigerant R407C (HFC) High Inlet Air Temperature **IDU□E Series**

## 22E, 37E, 55E, 75E

(Max. inlet air temperature: 80°C, Max. ambient temperature: 40°C)

### How to Order

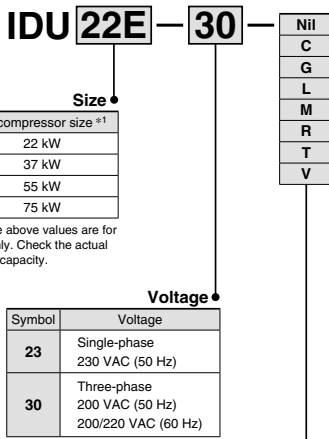

Symbol	Air compressor size *1
22E	22 kW
37E	37 kW
55E	55 kW
75E	75 kW

\*1 Note that the above values are for reference only. Check the actual compressor capacity.

Symbol	Voltage
23	Single-phase 230 VAC (50 Hz)
30	Three-phase 200 VAC (50 Hz) 200/220 VAC (60 Hz)

Symbol *1	Options							
	Nil	C	G	L	M	R	T	V
Description	None	Anti-corrosive treatment for copper tube	With Chinese labels and a Chinese operation manual	With a heavy-duty auto drain (applicable to moderate pressure *2)	With a motor type auto drain (Voltage symbol 30 only)	With an earth leakage breaker	With a terminal block for power supply, operating, and error signals *3	With a timer controlled solenoid valve type auto drain (Voltage symbol 23 only) (applicable to moderate pressure *2)
Size	●	●	●	●	●	●	●	●
22E	●	●	●	●	●	●	●	●
37E	●	●	●	●	●	●	●	●
55E	●	●	●	●	●	●	●	●
75E	●	●	●	●	●	●	●	●

\*1 When multiple options are combined, indicate symbols in alphabetical order. However, the following combinations are not possible.

- The combination of L, M and V is not possible because an auto drain can only be attached to a single option.

\*2 The maximum operating pressure is 1.6 MPa.

\*3 To users who are considering switching from the previous air dryer:

When switching from the previous air dryer and remote operation are required, select the Made to Order (IDU□E-□-X256) product.

\* Refer to pages 61 to 65 for further information on options.

## Standard Specifications



### Symbol

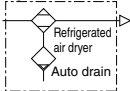

Specifications		Model	High inlet air temperature			
			IDU22E	IDU37E	IDU55E	IDU75E
Operating range <sup>①</sup>	Fluid	Compressed air				
	Inlet air temperature [°C]	5 to 80				
	Inlet air pressure [MPa]	0.15 to 1.0 <sup>②</sup>				
	Ambient temperature (Humidity) [°C]	2 to 40 (Relative humidity 85% or less)				
Air flow capacity <sup>③</sup> [m <sup>3</sup> /min]	Standard condition (ANR) <sup>①</sup>	50 Hz	3.9	5.7	8.4	11.0
		60 Hz	4.3	6.1	9.8	12.5
	Compressor intake condition <sup>②</sup>	50 Hz	4.1	6.1	8.9	11.7
		60 Hz	4.6	6.5	10.4	13.3
Rated conditions <sup>④</sup>	Inlet air pressure [MPa]	0.7				
	Inlet air temperature [°C]	55				
	Ambient temperature [°C]	32				
	Outlet air pressure dew point [°C]	10				
Power supply voltage (Frequency)		Single-phase: 230 VAC ±10% (50 Hz) Three-phase: 200 VAC (50 Hz) Three-phase: 200/220 VAC (60 Hz)				
Electric specifications <sup>⑤</sup>	Power consumption [W]	Three-phase 200 V	1100/1450		1570/2050	2200/2850
		50/60 Hz <sup>⑤,⑥</sup>	Single-phase 230 V (50 Hz)		960	1570
	Operating current [A]	Three-phase 200 V	4.2/4.8		6.7/7.3	8.2/9.3
		50/60 Hz <sup>⑤</sup>	Single-phase 230 V (50 Hz)		4.3	6.9
Applicable earth leakage breaker capacity <sup>⑦</sup> [A] <small>(Sensitivity of leak current of 30 mA)</small>	Three-phase 200 V	10		15	15	
	Single-phase 230 V (50 Hz)	10		10	20	
Refrigerant		R407C (HFC)				
Refrigerant charge [kg]	Three-phase 200 V	0.47	0.83	0.55	0.745	
	Single-phase 230 V	0.45	0.76	0.55	0.745	
Auto drain		Float type (Normally open)				
Port size		R1	R1 1/2	R2		
Weight [kg]		90	130	160	166	
Applicable air compressor output (Reference) For screw type [kW]		22	37	55	75	

① Air flow capacity under the standard condition (ANR) [20°C, Atmospheric pressure, and 65% Relative humidity]

② Air flow capacity converted by the compressor intake condition [32°C, Atmospheric pressure, and 75% Relative humidity]

③ The operation range does not guarantee the use with normal air flow capacity.

④ Select the model in accordance with Model Selection (pages 40, 41) for models beyond the rated specifications.

⑤ These values are reference values under rated conditions, and are not guaranteed. Do not use these values for the thermal set values, etc.

⑥ Product other than the Option R is not equipped with an earth leakage breaker. Purchase an appropriate earth leakage breaker separately.

⑦ For the IDU22 to 75E, cooling with the aftercooler helps reduce power consumption by up to 50%.

### Replacement Parts

Model		IDU22E	IDU37E	IDU55E	IDU75E
Auto drain replacement parts no. <sup>⑧</sup>	New	AD48-A			
	Previous	AD48			

⑧ The part number for the auto drain (Bowl assembly) components only excluding the body part. Body part replacement is not possible.

In addition, a new line of auto drain models was recently introduced in either March or June 2019.

The previous models and the new models do not have mounting interchangeability. For details, refer to page 76.

⑨ The maximum operating pressure is 1.0 MPa as standard, but it is possible to achieve 1.6 MPa when selecting Option L or Option V.

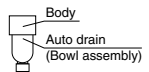

## Construction (Air/Refrigerant Circuit)

### IDU22E, IDU37E, IDU55E, IDU75E

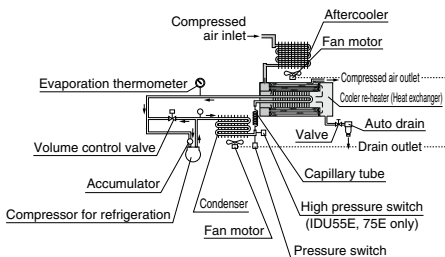

Humid, hot air coming into the air dryer will be cooled down by a heat exchanger. Water condensed at this time will be removed from the air by a drain separator and drained out automatically. Air separated from the water will be heated by a heat exchanger to obtain the dried air, which goes through to the outlet side.

## Dimensions

### IDU22E to 75E

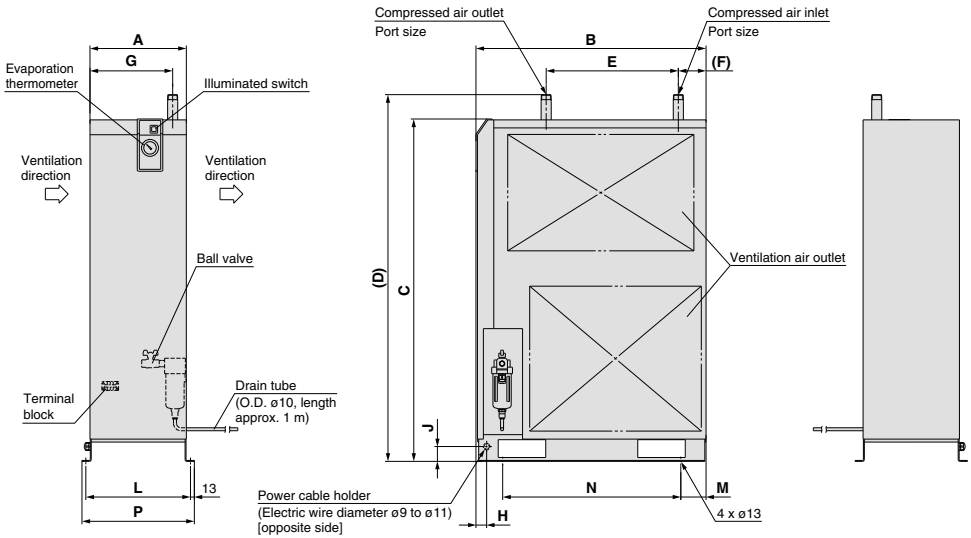

### Dimensions

[mm]

Model	Port size	A	B	C	D	E	F	G	H	J	L	M	N	P
IDU22E	R1	325	775	1153	1235	445	93	279			353	85	600	379
IDU37E	R1 1/2	360		1258	1350	550	64	290	46	50	388		680	414
IDU55E	R2	470	855	1345	1440	530	53	360	30		500	75	700	526
IDU75E				1480	1575					70				

# IDF/IDU Series Options

Refer to “How to Order” on pages 42, 46, 47, 52, 55, and 58 for optional models.

## **A** Option symbol **Cool compressed air output** IDF1E to 15E1

Cool outlet air (10°C) can be supplied.

The air flow with this option is smaller than that of the standard air dryer. (Refer to the table below.)

If the air dryer is used out of the scope of the rated specifications or conditions, select a model according to pages 40 and 41 and apply the air flow capacity shown in the tables below to the data (E).

\*1 Perform thermal insulation treatment for pipings and equipment installed after the dryer to prevent the formation of condensation.

\*2 The Option A cannot be used for the IDF100F to 370D and the IDU series due to the construction of the heat exchanger unit.

### Air Flow Capacity

Model	IDF1E	IDF2E	IDF3E	IDF4E	IDF6E	IDF8E	IDF11E	IDF15E1
Air flow capacity [m <sup>3</sup> /min (ANR)]	50 Hz 0.085	0.12	0.18	0.26	0.32	0.5	0.65	1.2
	60 Hz 0.1	0.14	0.21	0.29	0.375	0.55	0.75	1.3

(Rated conditions): Inlet air pressure: 0.7 MPa, Inlet air temperature: 35°C (IDF1E to 37E), 40°C (IDF5E, 75E), Outlet air temperature: 10°C

## **C** Option symbol **Anti-corrosive treatment for copper tube** IDF, IDU all models

This minimizes the corrosion of the copper and copper alloy parts when the air dryer is used in an atmosphere containing hydrogen sulfide or sulfuric acid gas. (Corrosion cannot be completely prevented.)

Special epoxy coating: Copper tube and copper alloy parts. The coating is not applied on the heat exchanger or around electrical parts, where operation may be affected by the coating.

\* Corrosion is not covered under warranty.

## **G** Option symbol **With Chinese labels and a Chinese operation manual** IDF1E to 15E1, IDU3E to 75E

In addition, Chinese labels are put on the external panels.

A Chinese operation manual is also included.

## **K** Option symbol **Moderate pressure specification (Auto drain bowl: Metal bowl with level gauge)** IDF6E to 15E1, IDU3E to 15E1

The maximum operating pressure is 1.6 MPa.

The auto drain is changed from the standard to the moderate pressure specification.

A metal bowl with a level gauge which can confirm the water level is used for the auto drain.

### Specifications

1. Maximum operating pressure: 1.6 MPa
2. Dimensions ... same as standard products

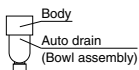

### Replacement Parts

Model	Auto drain replacement parts no.	Note
<b>IDF6E to 15E1</b> <b>IDU3E to 15E1</b>	IDF-S1926	The AD48-8-A-X2112 auto drain (bowl assembly) excluding the body, One-touch fitting: KQ2H10-02AS, and insulator

\* A new line of auto drain models was recently introduced in March 2019. The previous models and the new models do not have mounting interchangeability. For details, refer to page 76.

# IDF/IDU Series

## **K** Option symbol Moderate pressure specification

IDF100F to 150F

The maximum operating pressure is 1.6 MPa.  
The internal drain piping is changed from the nylon tube to the metal.

### Specifications

1. Maximum operating pressure: 1.6 MPa
2. Dimensions ... same as standard products

## **L** Option symbol With a heavy-duty auto drain (applicable to moderate pressure)

IDF4E to 15E1, IDF370D,  
IDU3E to 15E1, IDU22E to 75E

Drainage including dust can also be exhausted.  
The float type auto drain used in the standard air dryer is replaced with a heavy-duty auto drain (ADH4000-04).  
\* The IDF100F to 150F, 190D, 240D standard types are equipped with a heavy-duty auto drain.

Max. operating pressure: 1.6 MPa  
**IDF4E to 15E1**  
**IDU3E to 15E1**

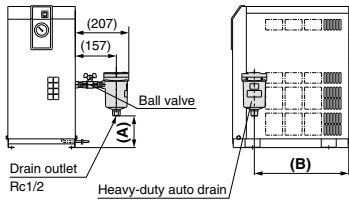

- \* The heavy-duty auto drain and the ball valve are both enclosed in the same shipping package as the main body of the air dryer. Customers are required to mount the parts to the air dryer.
- \* Customers will need to supply the fitting and tubing for the drain piping. (Excludes the IDF/IDU15E1)

### Dimensions [mm]

Model	A	B
IDF4E	55	348
IDF6E, IDU3E	67	
IDF8E, IDF11E	139	378
IDU4E, IDU6E		
IDU8E, IDU11E	149	494
IDF15E1	47	
IDU15E1		

### IDU22E to 75E

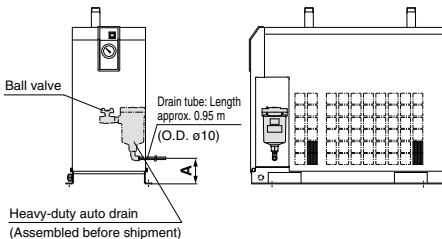

### Dimensions [mm]

Model	A
IDU22E, 37E	Approx. 100
IDU55E	Approx. 120
IDU75E	Approx. 250

Max. operating pressure: 0.97 MPa  
**IDF370D**

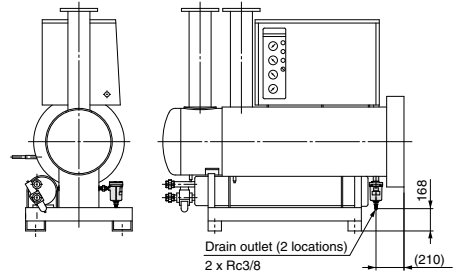

### Replacement Parts: Heavy-Duty Auto Drain

Model	Part no. (Description)	Configuration
IDF4E to 15E1 IDU3E to 15E1 IDF370D	ADH4000-04 (Heavy-duty auto drain)	Heavy-duty auto drain
IDU22E to 75E	ADH-E400 (Exhaust mechanism replacement kit)	Exhaust mechanism replacement kit
		Housing (Use existing equipment.)



Option symbol

**With a motor type auto drain**

**IDF4E to 15E1, 190D, 240D  
IDF3E to 75E**

The float type auto drain used in the standard air dryer is replaced with a motor type auto drain (ADM200).

\* The IDF370D standard type is equipped with a motor type auto drain.

**Air Discharge**

Operating air pressure	Air discharge without drainage
0.3 MPa	0.006 m <sup>3</sup> per cycle (ANR)
0.5 MPa	0.010 m <sup>3</sup> per cycle (ANR)
0.7 MPa	0.014 m <sup>3</sup> per cycle (ANR)

\* The motor type auto drain actuates for 2 seconds per cycle. The operating cycle is as follows. IDF4E to 75E, IDU3E to 37E: Once per minute, IDU55E, 75E: Twice per minute, IDF190D to 370D: 4 times per minute.

**IDF4E to 15E1  
IDU3E to 15E1**

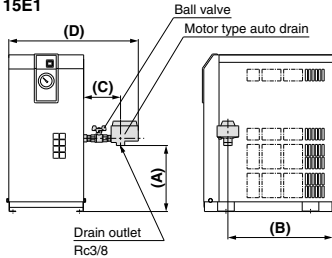

**Dimensions**

Model	A	B	C	D
<b>IDF4E</b>	154	348	133	474
<b>IDF6E, IDU3E</b>	166			
<b>IDF8E, 11E</b>	238			
<b>IDU4E, 6E</b>	238	378		
<b>IDU8E, 11E</b>	248			496
<b>IDF15E1</b>	149	494	146	510
<b>IDU15E1</b>	150	533	137	530

\* The motor type auto drain and the ball valve are both enclosed in the same shipping package as the main body of the air dryer. Customers are required to mount the auto drain to the air dryer.

\* Customers will need to supply the fitting and tubing for the drain piping. (Excludes the IDF/IDU15E1)

**IDU22E to 75E**

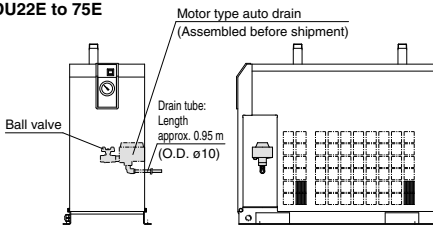

\* When a longer drain tube than the one attached is necessary, remove and replace it with a tube prepared by customers. (After connection with a fitting, the drain may not flow due to a drop in pressure caused by the fitting.)

**IDF190D, 240D**

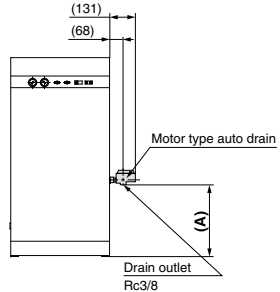

\* The motor type auto drain is enclosed in the same shipping package as the main body of the air dryer. Customers are required to mount the auto drain to the air dryer.

**Dimensions** [mm]

Model	A
<b>IDF190D</b>	525
<b>IDF240D</b>	565

**Replacement Parts: Motor Type Auto Drain Assembly** \*1

Model	Part no.	Note
<b>IDF4E to 15E1-10 IDU3E to 15E1-10</b>	IDF-S0087	Assembly of Motor type auto drain: ADM200-041, Plug housing assembly: 173090-2, Receptacle: 173707-1, Rubber plug: 172888-2
<b>IDF4E to 15E1-20 IDU3E to 15E1-20 IDU22E, 37E-30</b>	IDF-S0090	Assembly of Motor type auto drain: ADM200-042, Plug housing assembly: 173090-2, Receptacle: 173707-1, Rubber plug: 172888-2
<b>IDU55E, 75E</b>	IDF-S0510	Assembly of Motor type auto drain: ADM200-042-4, Plug housing assembly: 173090-2, Receptacle: 173707-1, Rubber plug: 172888-2
<b>IDF190D, 240D</b>	IDF-S0511	Assembly of Motor type auto drain: ADM200-042-8, Plug housing assembly: 173090-2, Receptacle: 173707-1, Rubber plug: 172888-2

\*1 Including electric wire with connector on the end



Option symbol

**With a metal name plate**

**IDF100F to 150F**

The label identifying the model and specifications of the product is changed to a metal plate which has better endurance.

# IDF/IDU Series

## R Option symbol With an earth leakage breaker

Except IDF1E, 2E, 3E

The air dryer is equipped with an earth leakage breaker, reducing the electrical wiring required during installation.  
(The IDF370D does not include the electrical leakage detection function.)

IDF4E to 15E1  
IDU3E to 15E1

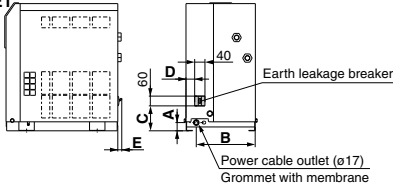

Dimensions [mm]					
Model	A	B	C	D	E
IDF4E, 6E, 8E, 11E	32	230	97	34	15
IDF15E1	43	258	102	82	—
IDU3E, 4E, 6E	32	230	97	34	15
IDU8E	42		100	37	—
IDU11E				75	
IDU15E1	43	258	102	82	

IDU22E to 75E

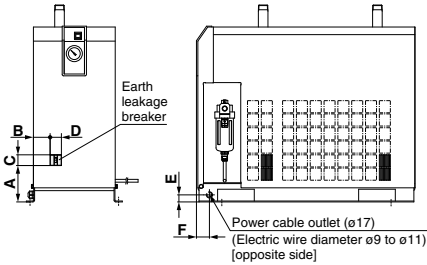

Dimensions [mm]						
Model	A	B	C	D	E	F
IDU22E-30	151	74	60	60	50	46
IDU37E-30	146	122			70	36
IDU55E-30	148	55				
IDU75E-30	166	73				

IDF100F to 150F

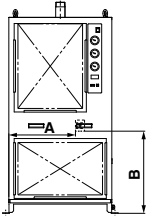

Dimensions [mm]		
Model	A	B
IDF100F	434	535
IDF125F	448	
IDF150F	628	537

IDF190D, 240D

IDF370D

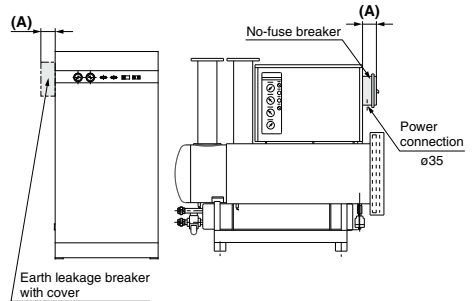

Dimensions [mm]	
Model	A
IDF190D	95
IDF240D	
IDF370D	

### Breaker Capacity and Sensitivity of Leak Current

Voltage	Model	Breaker capacity	Sensitivity of leak current
100 V type	IDF4E-10, IDF6E-10 IDF8E-10, IDF11E-10, IDF15E1-10	10 A	30 mA
	IDU3E-10, IDU4E-10, IDU6E-10 IDU8E-10, IDU11E-10, IDU15E1-10	5 A	
	IDF4E-20, IDF6E-20 IDF8E-20, IDF11E-20	10 A	
	IDU3E-20, IDU4E-20 IDU6E-20, IDU8E-20, IDU11E-20	15 A	
200 V type	IDF15E1-20 IDU15E1-20	30 A	
	IDU22E-30, IDU37E-30, IDU55E-30	50 A	
	IDU75E-30		
	IDF100F		
	IDF125F		
	IDF150F		
	IDF190D IDF240D IDF370D		



**S** Option symbol  
**Power supply terminal block connection** **IDF1E-10 to 15E1-10, IDU3E-10 to 15E1-10**

The option allows the connection of a power cable to a terminal block. This option is supplied with the 200 V model as a standard accessory.

**IDF1E-10 to 3E-10**

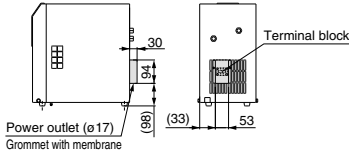

**IDF4E-10 to 15E1-10**  
**IDU3E-10 to 15E1-10**

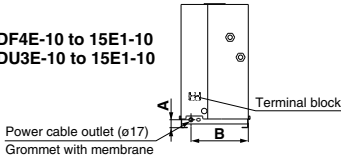

**Dimensions** [mm]

Model	A	B
<b>IDF4E, 6E, 8E, 11E</b>	32	230
<b>IDF15E1</b>	43	258
<b>IDU3E, 4E, 6E</b>	32	230
<b>IDU8E, 11E</b>	42	230
<b>IDU15E1</b>	43	258

**T** Option symbol  
**With a terminal block for power supply, operating, and error signals** **IDF4E to 15E1, IDU3E to 15E1**

In addition to power supply connection, entry of operating and error signals is available. (No-voltage contact)

Additionally, when using the remote operation, select the Made to Order (IDF8E to 15E1-□-X256, IDU8E to 15E1-□-X256) products.

**IDF4E to 15E1**  
**IDU3E to 15E1**

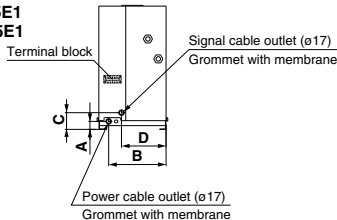

Contact capacity: 200 VAC/2 A  
 24 VDC/2 A  
 (Min. applicable load: 20 V/5 mA)

\* Be sure to confirm the electric circuits with the drawings or Operation Manual before using the operating and error signals.

**Dimensions** [mm]

Model	A	B	C	D
<b>IDF4E, 6E, 8E, 11E</b>	32	230	67	179
<b>IDF15E1</b>	43	258	77	158
<b>IDU3E, 4E, 6E</b>	32	230	67	179
<b>IDU8E, 11E</b>	42	230	77	136
<b>IDU15E1</b>	43	258	77	158

**T** Option symbol  
**With a terminal block for power supply, operating, and error signals** **IDU22E to 75E**

In addition to power supply connection, entry of operating and error signals is available. (No-voltage contact)

**IDU22E to 75E**

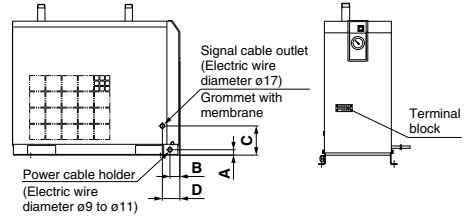

Contact capacity: 200 VAC/2 A  
 24 VDC/2 A  
 (Min. applicable load: 20 V/5 mA)

**Dimensions** [mm]

Model	A	B	C	D
<b>IDU22E, 37E</b>	50	46	166	81
<b>IDU55E</b>		36	230	
<b>IDU75E</b>	70		242	

**V** Option symbol  
**With a timer controlled solenoid valve type auto drain (applicable to moderate pressure)** **IDU3E to 75E-23**  
**IDF100F to 150F**

Drainage is discharged by controlling a solenoid valve with a timer. A strainer for solenoid valve protection and a stop valve are also included. (The external dimensions are the same as the standard product.)

Maximum operating pressure: 1.6 MPa (IDF100F to 150F: 1.0 MPa)

\* The timer controlled solenoid valve actuates once (for 0.5 seconds) every 30 seconds.

**Replacement Parts**

Model	Part no.	Note
<b>IDU3E to 37E-23</b>	IDF-S0198	230 VAC
<b>IDU55E, 75E-23</b>	IDF-S0302	
<b>IDF100F to 150F</b>	IDF-S0405	200 VAC

# IDF/IDU Series

## **W** Option symbol **Water-cooled type** IDF100F to 150F, 190D, 240D

It can be used in a high temperature environment without decreasing air flow capacity. It can also be used in an enclosed environment without increasing the ambient temperature. This option is supplied with the IDF370D as a standard accessory.

Model	IDF100F	IDF125F	IDF150F	IDF190D	IDF240D
Condenser	Plate system			Shell and coil system	
Cooling water flow rate [m <sup>3</sup> /h] *1 50/60 Hz	1.29/1.56	1.74/1.98	2.16/2.52	4.8/4.8	5.4/5.4
Cooling tower performance [RT] *2	2	2.4	3	7.5	7.5
Water flow regulator	Pressure type automatic water supply valve				
Port size for water side	R1/2	R3/4	R1		

\*1 Value with rated load when cooling water inlet temperature is 32°C.

\*2 Calculated at 1 RT = 3300 kcal/h

### IDF100F to 150F

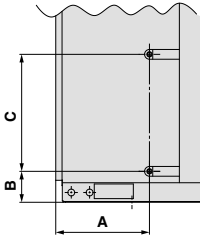

#### Dimensions [mm]

Model	A	B	C
IDF100F	384		479
IDF125F, 150F	234	127	

### IDF190D, 240D

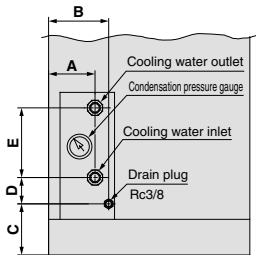





#### Dimensions [mm]

Model	A	B	C	D	E
IDF190D, 240D	180	250	160	48	273

# IDF/IDU Series

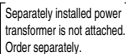
## Optional Accessories

### Specifications

Description	Features	Specifications	Applicable air dryer	Dimensions
<b>Separately installed power transformer</b> *1, 2, 3 	Power supply and voltage for those other than the standard.	Max. ambient temperature 40°C (Relative humidity 85% or less)	IDF1E-10 to IDF15E1-10 IDU3E-10 to 15E1-10, IDU22E to 75E-30 IDF100F to 150F, IDF190D to 370D-3	p. 69, 70
<b>Dedicated base for separately installed power transformer</b> *2 	For integrating the separately installed power transformer and the air dryer. <small>Separately installed power transformer is not attached. Order separately.</small>	—	IDF4E to 15E1-10 IDU3E to 15E1-10	p. 71
<b>Dust-protecting filter set</b> *4 	For preventing a decline in the performance of air dryers, even in a dusty atmosphere.	Max. ambient temperature 40°C	IDF1E to 15E1 IDF190D to 240D IDU3E to 75E	p. 72
<b>Bypass piping set</b> 	Easy bypass piping (connect this set to the air dryer), allowing substantial reduction in the installation time.	Max. operating pressure *5 1.0 MPa Max. operating temperature IDF: 60°C IDU: 80°C	IDF1E to 15E1 IDU3E to 75E	p. 73, 74
<b>Foundation bolt set</b> 	For fixing the air dryer to the foundations. Easy to secure by striking the axle.	Stainless steel	IDF4E to 15E1 IDU3E to 75E IDF100F to 150F	p. 74
<b>Piping adapter</b> 	For converting the thread type of an IN/OUT fitting for air dryers.	Brass	IDF1E to 15E1 IDU3E to 75E IDF100F to 150F	
<b>Conversion piping set</b>	[When bypass piping is already in place] For ensuring conversion to the former models' (IDF6D to 15C) air piping.	Max. operating pressure *5 1.0 MPa Max. operating temperature 60°C	IDF6E to 15E1	p. 75
<b>Conversion bypass piping set</b>	[When there is no bypass piping] For ensuring conversion to the former models' (IDF6D to 15C) air piping.	Max. operating pressure *5 1.0 MPa Max. operating temperature 60°C	IDF6E to 15E1	p. 75

- \*1 When using a power transformer for the IDF1E to 15E1 and IDU3E to 15E1, select the air dryer of 100 V.  
 \*2 When using a power transformer for the IDF190D and 240D, built-in transformer type is also available. (Refer to the How to Order on page 52.)  
 \*3 This transformer does not have CE/UKCA marking and is not compliant with UL standards.  
 \*4 This filter set is supplied with the IDF100F to 150F as a standard accessory.  
 \*5 Not applicable to the moderate pressure specification. Prepare a bypass, conversion or conversion bypass piping set suitable for the specification.

### How to Order

#### [Separately installed power transformer]

This transformer does not have CE/UKCA marking and is not compliant with UL standards.

Single-phase type **IDF — TR500 — 2**

#### Capacity

Symbol	Applicable air dryer	Capacity
500	IDF1E-10 to IDF8E-10 IDU3E-10, IDU4E-10, IDU8E-10	500 VA
1000	IDF11E-10, IDF15E1-10 IDU6E-10, IDU11E-10, IDU15E1-10	1 kVA

#### Power supply voltage

Symbol	Inlet voltage	Outlet voltage	Type
1	110 VAC (50 Hz) 110 to 120 VAC (60 Hz)	100 VAC (50 Hz) 100, 110 VAC (60 Hz)	Single-phase
2	200, 220, 230, 240 VAC (50 Hz) 200 to 260 VAC (60 Hz)		
3	380, 400, 415 VAC (50 Hz) 380 to 420 VAC (60 Hz)		
4	420, 440, 480 VAC (50 Hz) 420 to 520 VAC (60 Hz)		

\* Refer to pages 69 and 70 for dimensions.

Three-phase type **IDF — TR1700 — 5**

#### Capacity

Symbol	Applicable air dryer	Capacity
1700	IDU22E-30, IDU37E-30	1.7 kVA
4000	IDU55E-30, IDU75E-30	4 kVA
7000	IDF100F	7 kVA
9000	IDF125F, 150F	9 kVA
14000	IDF190D, 240D	14 kVA
18000	IDF370D	18 kVA

#### Power supply voltage

Symbol	Inlet voltage	Outlet voltage	Type
5	220 VAC (50 Hz) 220 to 240 VAC (60 Hz)	200 VAC (50 Hz) 200, 220 VAC (60 Hz)	Three-phase
6	380, 400, 415 VAC (50 Hz) 380 to 440 VAC (60 Hz)		
7	440, 460 VAC (50 Hz) 440 to 500 VAC (60 Hz)		
8	220, 240, 380, 400, 415, 440 VAC (50/60 Hz)		

\* Refer to page 70 for dimensions.

# IDF/IDU Series

## How to Order

[Dedicated base for separately installed power transformer]

IDF — TB **403**

IDU — TB **407**

Size ↓

Symbol	Applicable air dryer
<b>403</b>	IDF4E to 11E, IDU3E to 6E
<b>404</b>	IDF15E1

Size ↓

Symbol	Applicable air dryer
<b>407</b>	IDU8E, IDU11E
<b>408</b>	IDU15E1
<b>410</b>	IDU22E
<b>411</b>	IDU37E

\* Not available for the IDF1E to 3E, IDU55E, 75E, IDF100F to 150F, IDF190D, 240D, 370D.  
In the case of the Option S, the part number will be different. Please consult with SMC separately.  
Refer to page 71 for dimensions.

[Dust-protecting filter set]

IDF — FL **201**

IDF — FL **190** D

IDU — FL **210**

Applicable air dryer ↓

Symbol	Applicable air dryer
<b>200</b>	IDF1E, 2E
<b>201</b>	IDF3E
<b>202</b>	IDF4E
<b>203</b>	IDF6E, IDU3E
<b>204</b>	IDF8E, IDU4E
<b>205</b>	IDF11E, IDU6E
<b>206</b>	IDF15E1

Applicable air dryer ↓

Symbol	Applicable air dryer
<b>190</b>	IDF190D
<b>240</b>	IDF240D

\* This filter set is supplied with the IDF100F to 150F as a standard accessory.  
Refer to page 72 for dimensions.

Applicable air dryer ↓

Symbol	Applicable air dryer
<b>210</b>	IDU8E
<b>211</b>	IDU11E
<b>212</b>	IDU15E1
<b>215</b>	IDU22E
<b>216</b>	IDU37E
<b>217</b>	IDU55E
<b>218</b>	IDU75E

[Bypass piping set (Rc, R thread)]

IDF — BP **302**

IDU — BP **305**

IDF — AB **500**

Applicable air dryer ↓

Symbol	Applicable air dryer	Thread type
<b>300</b>	IDF1E	Rc
<b>301</b>	IDF2E	
<b>302</b>	IDF3E	
<b>303</b>	IDF4E	
<b>304</b>	IDF6E to 11E	
<b>316</b>	IDF15E1	

\* Not applicable to the moderate pressure specification (maximum operating pressure 1.6 MPa). Prepare a bypass piping set suitable for the specification by customers.

Applicable air dryer ↓

Symbol	Applicable air dryer
<b>305</b>	IDU3E
<b>306</b>	IDU4E
<b>307</b>	IDU6E
<b>320</b>	IDU8E, IDU11E
<b>322</b>	IDU15E1
<b>336</b>	IDU22E
<b>337</b>	IDU37E
<b>338</b>	IDU55E, IDU75E

\* Refer to pages 73 and 74 for bypass piping set dimensions.

Applicable air dryer ↓

Symbol	Applicable air dryer
<b>500</b>	IDF4E to 75E IDU3E to 15E1
<b>501</b>	IDF100F to 150F IDU22E to 75E

\* Refer to page 74 for dimensions.

[Piping adapter]

IDF — AP **601**

• Applicable air dryer

Symbol	Thread type and port size		Applicable air dryer
	Male thread A side	Female thread B side	
<b>601</b>	R1/2	NPT1/2	IDF4E, IDU4E
<b>603</b>	R3/4	NPT3/4	IDF6E to 11E, IDU6E to 11E
<b>604</b>	NPT1	Rc1	IDU22E
<b>605</b>	R1	NPT1	IDF15E1, IDU15E1
<b>606</b>	NPT1 1/2	Rc1 1/2	IDU37E
<b>607</b>	NPT2	Rc2	IDF100F to 150F
<b>609</b>	R3/8	NPT3/8	IDF1E to 3E, IDU3E

\* Refer to page 74 for dimensions.

[Conversion piping set/  
Conversion bypass piping set]

Applicable to the IDF6E to 15E1.  
Select Conversion Piping Set when bypass piping is already in place, and Conversion Bypass Piping Set when there is no bypass piping.

Part no.		Applicable air dryer
Conversion piping set	Conversion bypass piping set	
<b>IDF-S0186</b>	<b>IDF-S0183</b>	IDF6E
<b>IDF-S0203</b>	<b>IDF-S0202</b>	IDF8E
<b>IDF-S0187</b>	<b>IDF-S0184</b>	IDF11E
<b>IDF-S0188</b>	<b>IDF-S0185</b>	IDF15E1

\* Refer to page 75 for dimensions.

## Specifications/Dimensions

### [Separately installed power transformer]

This transformer does not have CE/UKCA marking and is not compliant with UL standards.

#### IDF-TR□-1

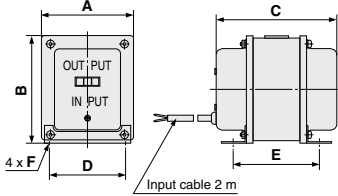

#### Specifications/Dimensions

											[mm]	
Part no.	Applicable air dryer	Capacity	Type	Inlet voltage	Outlet voltage	A	B	C	D	E	F	Weight
IDF-TR500-1	IDF1E-10 to 8E-10 IDU3E-10, 4E-10, 8E-10	500 VA	Single-phase Single-turm	110 VAC (50 Hz)	100 VAC (50 Hz)	78	94	100	64	75	4.2 x 7 (Long hole)	1.5 kg
				110 to 120 VAC (60 Hz)	110 VAC (60 Hz)	104	122	134	75	114	4.2 x 9 (Long hole)	
IDF-TR1000-1	IDF11E-10, 15E1-10 IDU6E-10, 11E-10, 15E1-10	1 kVA										4 kg

#### IDF-TR□-2

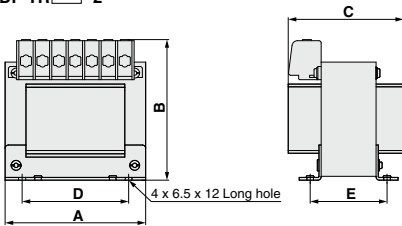

#### Specifications/Dimensions

											[mm]
Part no.	Applicable air dryer	Capacity	Type	Inlet voltage	Outlet voltage	A	B	C	D	E	Weight
IDF-TR500-2	IDF1E-10 to 8E-10 IDU3E-10, 4E-10, 8E-10	500 VA	Single-phase Single-turm	200, 220 230, 240 VAC (50/60 Hz)	100 VAC (50/60 Hz)	128	131	105	97	70	5.8 kg
	IDF-TR1000-2	IDF11E-10, 15E1-10 IDU6E-10, 11E-10, 15E1-10		1 kVA			146	143	132	110	82

#### IDF-TR□-3, 4

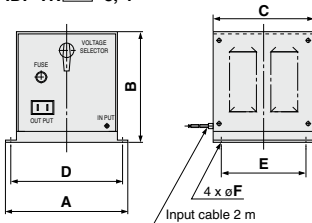

#### Specifications/Dimensions

											[mm]	
Part no.	Applicable air dryer	Capacity	Type	Inlet voltage	Outlet voltage	A	B	C	D	E	F	Weight
IDF-TR500-3	IDF1E-10 to 8E-10 IDU3E-10, 4E-10, 8E-10	500 VA	Single-phase Single-turm	380, 400, 415 VAC (50 Hz)	100 VAC (50 Hz) 110 VAC (60 Hz)	230	207	190	210	160	9	15 kg
IDF-TR1000-3	IDF11E-10, 15E1-10 IDU6E-10, 11E-10, 15E1-10	1 kVA		380 to 420 VAC (60 Hz)								
IDF-TR500-4	IDF1E-10 to 8E-10 IDU3E-10, 4E-10, 8E-10	500 VA		420, 440, 480 VAC (50 Hz)								
IDF-TR1000-4	IDF11E-10, 15E1-10 IDU6E-10, 11E-10, 15E1-10	1 kVA		420 to 520 VAC (60 Hz)								

# IDF/IDU Series

## Specifications/Dimensions

[Separately installed power transformer]

### IDF-TR1700-5

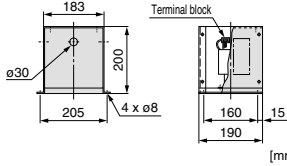

#### Specifications

Part no.	Applicable air dryer	Capacity	Type	Inlet voltage	Outlet voltage	Weight
IDF-TR1700-5	IDU22E-30	1.7 kVA	Three-phase Single-tum	220 VAC (50 Hz)	200 V (50 Hz)	9 kg
	IDU37E-30			220 to 240 VAC (60 Hz)	200, 220 V (60 Hz)	

### IDF-TR1700-6,7

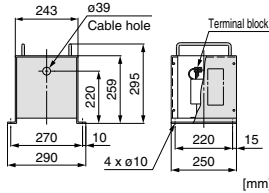

#### Specifications

Part no.	Applicable air dryer	Capacity	Type	Inlet voltage	Outlet voltage	Weight
IDF-TR1700-6	IDU22E-30 IDU37E-30	1.7 kVA	Three-phase Single-tum	380, 400, 415 VAC (50 Hz)	200 V (50 Hz) 200, 220 V (60 Hz)	18 kg
				380 to 400, 400 to 415, 415 to 440 VAC (60 Hz)		
IDF-TR1700-7				440, 460 VAC (50 Hz) 440 to 460, 460 to 500 VAC (60 Hz)		

### IDF-TR4000-5,6,7

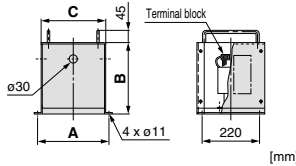

#### Specifications/Dimensions

Part no.	Applicable air dryer	Capacity	Type	Inlet voltage	Outlet voltage	A	B	C	Weight
IDF-TR4000-5	IDU55E-30 IDU75E-30	4 kVA	Three-phase Single-tum	220 V (50 Hz)	200 V (50 Hz)	275	259	240	14 kg
				220 to 240 V (60 Hz)	200, 220 V (60 Hz)				
IDF-TR4000-6				380, 400, 415 V (50 Hz) 380 to 400, 400 to 415, 415 to 440 V (60 Hz)	200 V (50 Hz) 200, 220 V (60 Hz)	355	299	320	35 kg
IDF-TR4000-7				440, 460 V (50 Hz) 440 to 460, 460 to 500 V (60 Hz)	200 V (50 Hz) 200, 220 V (60 Hz)	355	299	320	42 kg

### IDF-TR□-8

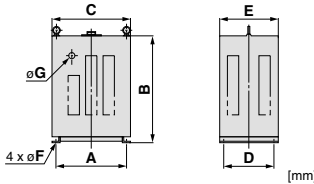

#### Specifications/Dimensions

Part no.	Applicable air dryer	Capacity	Type	Inlet voltage	Outlet voltage	A	B	C	D	E	F	G	Weight
IDF-TR7000-8	IDF100F	7 kVA	Three-phase	220, 240, 380, 400, 415, 440 V (50/60 Hz)	200 V (50/60 Hz)	360	540	400	260	300	11	30	94 kg
IDF-TR9000-8	IDF125F, 150F	9 kVA		400		650	450	300	350	13	40	109 kg	
IDF-TR14000-8	IDF190D, 240D	14 kVA		400		650	450	300	350	13	40	152 kg	
IDF-TR18000-8	IDF370D	18 kVA	turn	440 V (50/60 Hz)		400	650	450	300	350	13	40	179 kg

## Dimensions

[Dedicated base for separately installed power transformer]

IDF4E to 15E1  
IDU3E to 37E

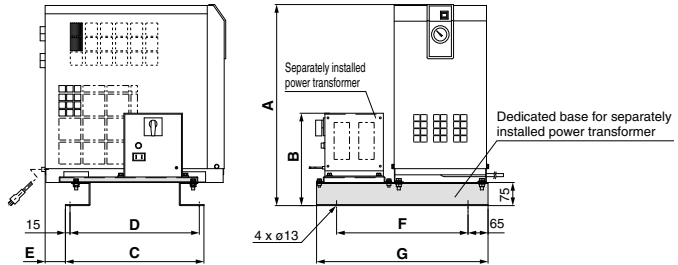

### IDF-TB□/Dimensions

											[mm]								
Part no.	Applicable air dryer	Applicable transformer	A	B	C	D	E	F	G	Unit weight [kg]	Reference weight (including air dryer and transformer) [kg]								
IDF-TB403	IDF4E-10	IDF-TR500-1	573	171	345	315	45	385	515	6	29.5								
		IDF-TR500-2		208							34								
		IDF-TR500-3		284							43								
		IDF-TR500-4		171							50								
	IDF6E-10 IDU3E-10	IDF-TR500-1	643	171	370	340	45	385	515	6	30.5								
		IDF-TR500-2		208							35								
		IDF-TR500-3		284							44								
		IDF-TR500-4		171							51								
	IDF8E-10 IDU4E-10	IDF-TR500-1	643	171	370	340	45	385	515	6	34.5								
		IDF-TR500-2		208							39								
		IDF-TR500-3		284							48								
		IDF-TR500-4		171							55								
		IDF11E-10 IDU6E-10		IDF-TR1000-1							643	199	370	340	45	385	515	6	38
				IDF-TR1000-2								220							44
IDF-TR1000-3	284		49																
IDF-TR1000-4	171		56																
IDF15E-10	IDF-TR1000-1	653	199	450	420	66	427	557	7	57									
	IDF-TR1000-2		220							63									
	IDF-TR1000-3		284							68									
	IDF-TR1000-4		171							75									

### IDU-TB□/Dimensions

												[mm]
Part no.	Applicable air dryer	Applicable transformer	A	B	C	D	E	F	G	Unit weight [kg]	Reference weight (including air dryer and transformer) [kg]	
IDU-TB407	IDU8E-10	IDF-TR500-1	934	171	370	340	45	475	605	6	51.5	
		IDF-TR500-2		208							56	
		IDF-TR500-3		284							65	
		IDF-TR500-4		171							72	
	IDU11E-10	IDF-TR1000-1	984	199	370	340	45	475	605	6	57	
		IDF-TR1000-2		220							63	
IDU-TB408	IDU15E-10	IDF-TR1000-1	1035	199	540	510	31	487	617	10	85	
		IDF-TR1000-2		220							91	
		IDF-TR1000-3		284							96	
		IDF-TR1000-4		171							103	
IDU-TB410	IDU22E-30	IDF-TR1700-5	1310	293	630	600	70	715	845	12	111	
		IDF-TR1700-6, 7		352							120	
IDU-TB411	IDU37E-30	IDF-TR1700-5	1425	293	710	680	70	750	880	13	152	
		IDF-TR1700-6, 7		352							161	

# IDF/IDU Series

## Dimensions

[Dust-protecting filter set]

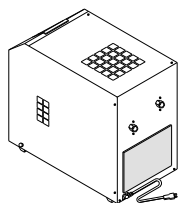

(IDF-FL200, 201)

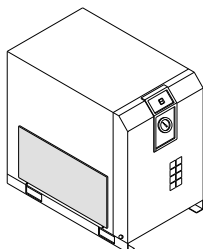

(IDF-FL202 to 214)

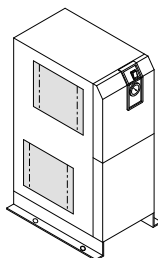

(IDU-FL210 to 218)

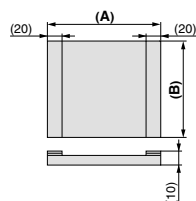

Dimensions		[mm]		
Part no.	Applicable air dryer	A	B	Weight [g]
IDF-FL200	IDF1E, 2E	220	150	20
			200	30
IDF-FL201	IDF3E	310	195	45
IDF-FL202	IDF4E			55
IDF-FL203	IDF6E, IDU3E	340	265	70
IDF-FL204	IDF8E, IDU4E	375		75
IDF-FL205	IDF11E, IDU6E	440	375	120
IDF-FL206	IDF15E1	440	375	120

\* A filter set for the IDF-FL200 to 214 consists of 1 filter.

Dimensions		[mm]		
Part no.	Applicable air dryer	A	B	Weight [g]
IDU-FL210	IDU8E	375	265	75
		375	265	75
IDU-FL211	IDU11E	375	265	75
		360	320	90
IDU-FL212	IDU15E1	440	370	120
		440	375	120

\* A filter set for the IDU-FL210 to 212, 215 to 218 consists of 2 filters.

Dimensions		[mm]	
Part no.	Applicable air dryer	A	B
IDF-FL190D	IDF190D	250	480
		750	480
		440	670
IDF-FL240D	IDF240D	600	670

\* A filter set for the IDF-FL190D to 240D consists of 4 filters.



## Dimensions

### [Bypass piping set] IDF1E to 3E

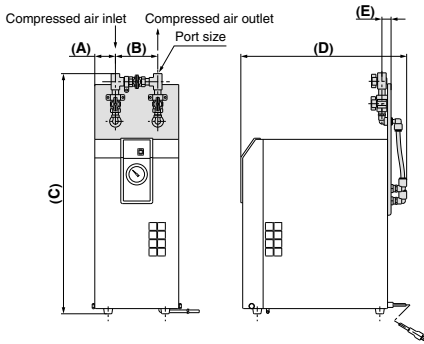

### Dimensions

[mm]								
Part no.	Applicable air dryer	Port size Rc	A	B	C	D	E	Weight [kg]
<b>IDF-BP300</b>	IDF1E	3/8	56	114	549	440	21	1.5
<b>IDF-BP301</b>	IDF2E				628	443		1.6
<b>IDF-BP302</b>	IDF3E				642	445		

### IDF4E to 15E1 IDU3E to 6E

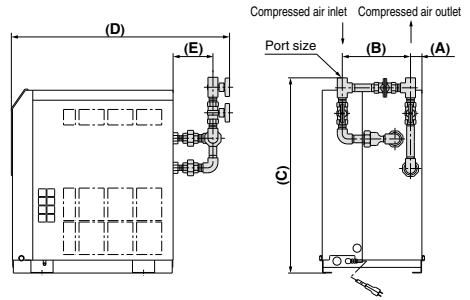

### Dimensions

[mm]								
Part no.	Applicable air dryer	Port size Rc	A	B	C	D	E	Weight [kg]
<b>IDF</b>	<b>IDF-BP303</b>	IDF4E	31	175	531	595	110	2.3
		IDF6E			555	617		
	<b>IDF-BP304</b>	IDF8E	3/4	187	627	647	129	3.3
		IDF11E						
<b>IDU</b>	<b>IDF-BP316</b>	IDF15E1	41	210	710	774	136	5.3
	<b>IDU-BP305</b>	IDU3E	31	175	506	572	100	1.6
	<b>IDU-BP306</b>	IDU4E			603	625		110
	<b>IDU-BP307</b>	IDU6E	3/4	187	627	647	129	3.3

### IDU22E to 75E

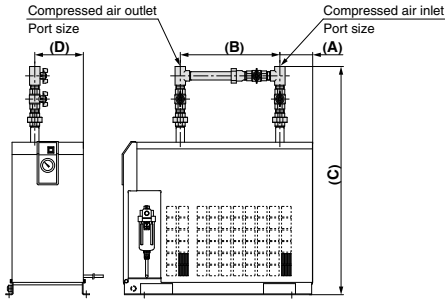

### Dimensions

[mm]								
Part no.	Applicable air dryer	Port size Rc	A	B	C	D	Weight [kg]	
<b>IDU</b>	<b>IDU-BP336</b>	IDU22E	1	93	445	1465	46	4.5
	<b>IDU-BP337</b>	IDU37E	1 1/2	64	550	1635	70	8.0
	<b>IDU-BP338</b>	IDU55E	2	53	530	1783	110	12.3
		IDU75E				1918		

# IDF/IDU Series

## Dimensions

[Bypass piping set]  
IDU8E to 15E1

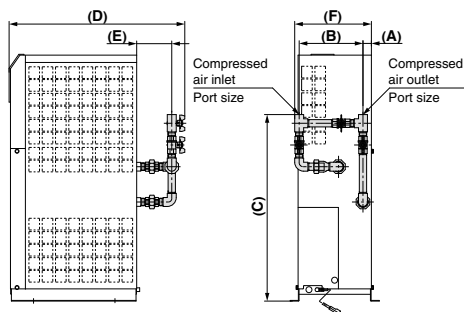

### Dimensions

Part no.	Applicable air dryer	Port size Rc	[mm]					Weight [kg]
			A	B	C	D	E	
IDU-BP320	IDU8E	3/4	31	210	687	647	129	3.6
	IDU11E				745	791		
IDU-BP322	IDU15E1	1	79			136	5.3	

[Foundation bolt set]

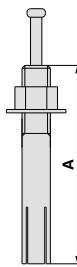

Mounting hole dia.:  $\phi 10.5$

### Dimensions

Part no.	Applicable air dryer	Nominal thread size	Material	Number of 1 set	[mm]
					A
IDF-AB500	IDF4E to 75E	M10	Stainless steel	4	50
	IDU3E to 15E1				70
IDF-AB501	IDU22E to 75E	M10	Stainless steel	4	70
	IDF100 to 150F				

[Piping adapter]

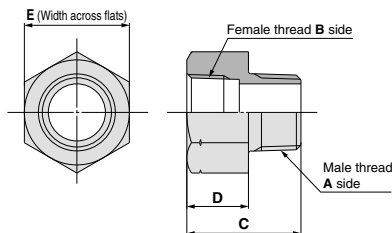

### Dimensions

Part no.	Thread type and port size		Applicable air dryer	C	D	E	Material	Number of 1 set
	Male thread A side	Female thread B side						
IDF-AP601	R1/2	NPT1/2	IDF4E IDU4E	38	20	26	Brass	2
IDF-AP603	R3/4	NPT3/4	IDF6E to 11E IDU6E to 11E	43	23	32		
IDF-AP604	NPT1	Rc1	IDF22E, IDU22E	50	27	46		
IDF-AP605	R1	NPT1	IDF15E1, IDU15E1					
IDF-AP606	NPT1 1/2	Rc1 1/2	IDU37E	55	31	54		
IDF-AP607	NPT2	Rc2	IDU55E, 75E IDF100 to 150F	65	35	70		
IDF-AP609	R3/8	NPT3/8	IDF1E to 3E IDU3E	30	15	22		

## Dimensions

### [Conversion piping set]

**IDF6E**

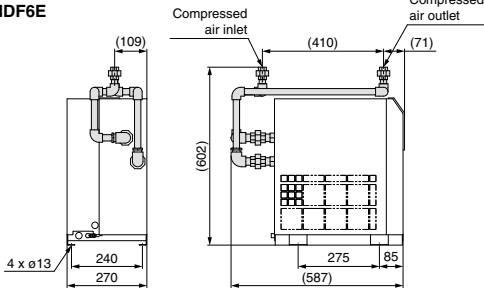

### Port Size

Part no.	Applicable air dryer	Port size Rc	Weight [kg]
<b>IDF-S0186</b>	IDF6E	1/2	3.5

### [Conversion piping set]

**IDF15E1**

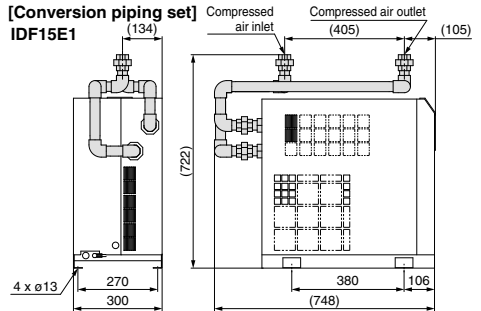

### Port Size

Part no.	Applicable air dryer	Port size Rc	Weight [kg]
<b>IDF-S0188</b>	IDF15E1	1	6.7

**IDF8E, 11E**

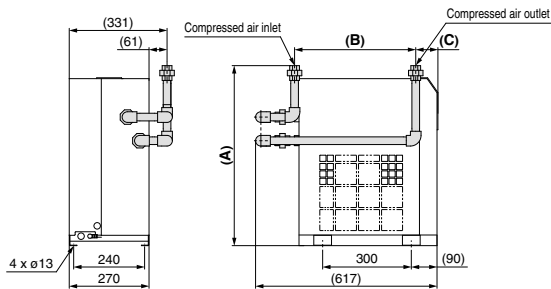

### Dimensions

Part no.	Applicable air dryer	Port size Rc	A	B	C	Weight [kg]
<b>IDF-S0203</b>	IDF8E	3/4	609	410	75	3.8
<b>IDF-S0187</b>	IDF11E	3/4	669	405	89	4.0

### [Conversion bypass piping set]

**IDF6E to 15E1**

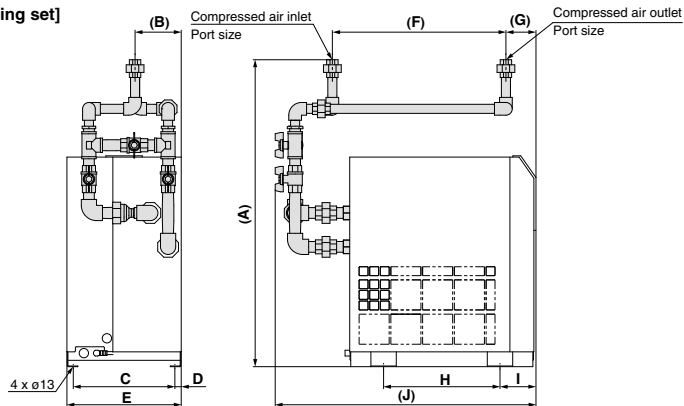

### Dimensions

Part no.	Applicable air dryer	Port size Rc	A	B	C	D	E	F	G	H	I	J	Weight [kg]
<b>IDF-S0183</b>	IDF6E	1/2	725	109	240	15	270	410	71	275	85	616	5.6
<b>IDF-S0202</b>	IDF8E	3/4	749	111	240	15	270	410	75	300	90	646	6.1
<b>IDF-S0184</b>	IDF11E	3/4	815	138	240	15	270	405	89	300	90	653	6.3
<b>IDF-S0185</b>	IDF15E1	1	897	135	270	15	300	405	105	380	106	775	10.2

# IDF/IDU Series

## Auto Drain Replacement Parts: Previous and New Model Product Nos.

A new line of auto drain models, which feature new product numbers and a new shape, was recently introduced, with manufacturing starting in either March or June 2019 (depending on the model). The previous auto drain models and the new auto drain models do not have mounting interchangeability. Please check the serial number on the dryer specification label before ordering.

### Auto drain (Bowl assembly)

Previous model



Metal bowl guard

New model



Transparent bowl guard  
(Polycarbonate)

Dryer model	Auto drain (Bowl assembly) part no.	Manufacturing date	SERIAL No.
IDF1E	Previous <b>AD37</b>	Manufactured in February 2019 and before	<b>XP and before</b>
	New <b>AD37-A</b>	Manufactured in March 2019 and after	<b>XQ and after</b>
IDF2E/3E/4E	Previous <b>AD38</b>	Manufactured in February 2019 and before	<b>XP and before</b>
	New <b>AD38-A</b>	Manufactured in March 2019 and after	<b>XQ and after</b>
IDF6E/8E/11E/15E1/22E/37E IDU3E/4E/6E/8E/11E/15E1/22E/37E	Previous <b>AD48</b>	Manufactured in February 2019 and before	<b>XP and before</b>
	New <b>AD48-A</b>	Manufactured in March 2019 and after	<b>XQ and after</b>
IDF55E/75E IDU55E/75E	Previous <b>AD48</b>	Manufactured in May 2019 and before	<b>XS and before</b>
	New <b>AD48-A</b>	Manufactured in June 2019 and after	<b>XT and after</b>

### Option: K Moderate pressure specification (Auto drain bowl type: Metal bowl with level gauge)

Previous model



New model



Dryer model	Auto drain (Bowl assembly) part no.	Manufacturing date	SERIAL No.
IDF6E/8E/11E/15E1 -K IDU3E/4E/6E/8E/11E/15E1 -K	Previous <b>IDF-S0086</b> <sup>*1</sup>	Manufactured in February 2019 and before	<b>XP and before</b>
	New <b>IDF-S1926</b> <sup>*2</sup>	Manufactured in March 2019 and after	<b>XQ and after</b>
IDF22E/37E -K	Previous <b>AD48-8-X2110</b>	Manufactured in February 2019 and before	<b>XP and before</b>
	New <b>AD48-8-A-X2112</b>	Manufactured in March 2019 and after	<b>XQ and after</b>

\*1 Assembly of auto drain: AD48-8-X2110, One-touch fitting: KQ2H10-02AS, and insulator  
\*2 Assembly of auto drain: AD48-8-A-X2112, One-touch fitting: KQ2H10-02AS, and insulator

### Dryer specification label Serial number confirmation method

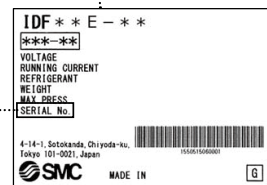
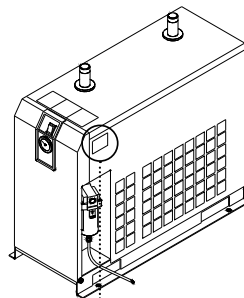

Specification Label

SERIAL No.: **X** **Q**

Manufacturing  
year

Symbol	Year
<b>A</b>	1996
<b>B</b>	1997
:	:
<b>W</b>	2018
<b>X</b>	2019
<b>Y</b>	2020
:	:

Manufacturing  
month

Symbol	Month
<b>o</b>	1
<b>P</b>	2
<b>Q</b>	3
<b>R</b>	4
<b>S</b>	5
<b>T</b>	6
<b>U</b>	7
<b>V</b>	8
<b>W</b>	9
<b>X</b>	10
<b>y</b>	11
<b>Z</b>	12



## IDF/IDU Series

# Specific Product Precautions 1

Be sure to read this before handling the products. For safety instructions and air preparation equipment precautions, refer to the “Handling Precautions for SMC Products” and the “Operation Manual” on the SMC website: <https://www.smcworld.com>

### Installation

#### Caution

- Avoid locations where the air dryer will be in direct contact with wind and rain. (Avoid locations where relative humidity is 85% or more.)
- Avoid exposure to direct sunlight.
- Avoid locations that contain much dust, corrosive gases, or flammable gases. Failure due to corrosion is not covered under warranty. However, when the risk of corrosion is high, select the Option C (anti-corrosive treatment for copper tube).
- Avoid locations of poor ventilation and high temperature.
- Avoid locations where the air dryer is too close to a wall, etc. Leave a sufficient space between the air dryer and the wall according to the Maintenance Space in the Operation Manual.
- Avoid locations where the air dryer could draw in high temperature air discharged from an air compressor or other dryer.

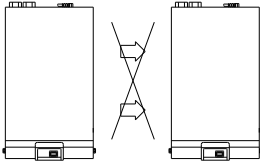

Confirm that the exhaust air does not flow into the neighboring equipment.

- Avoid locations where vibrations occur.
- Avoid possible locations where the drain can freeze.
- Avoid locations with an ambient temperature 40°C or higher (IDF100F to 150F: 45°C or higher).
- Avoid installation on machines for transporting, such as vehicles, ships, etc.
- Avoid locations where rapid pressure fluctuation or flow speed change is generated.
- When installing in locations where the dripping of condensation is a problem  
Depending on the operating conditions, the product and its downstream pipes could drip water due to condensation formed by supercooling.  
If this is a problem, install a drain receiver below this product or the condensation points and empty it regularly.  
Alternatively, wind additional insulation around the condensation points.

### Drain Tube

#### Caution

- A polyurethane tube is attached as a drain tube for the IDF1E to 150F, IDU3E to 75E. Use this tube to discharge drainage to a drain tank, etc.
- Do not use the drain tube in an upward direction. Do not bend or crush the drain tube. (Otherwise, the operation of an auto drain will stop and drainage will discharge through the air outlet.) If it is unavoidable that the tube goes upward, make sure it only goes as far as the position of the auto drain outlet.
- The drain tube comes with a tube fitting. Pipe a 10 mm O.D. tube with a length of 5 m or less.

### Power Supply

#### Caution

##### <100 VAC>

- Insert the power supply plug to an exclusive 100 VAC power outlet.
- Install an earth leakage breaker\*1 suitable to each model for the power supply.
- Maintain voltage range within  $\pm 10\%$  of the rated voltage.
- Be sure to ground the power supply prior to use.
- Multiple-branch wiring is dangerous since it causes overheating.
- Do not extend the power cable by using a table tap, etc.  
A voltage drop may cause the air dryer to stop operating.

\*1 Select an earth leakage breaker with a sensitivity of leak current of 30 mA and a rated current of 10 A.

##### <200 VAC>

- Connect the power supply to the terminal block.
  - Install an earth leakage breaker\*2 suitable to each model for the power supply.
  - Maintain voltage range within  $\pm 10\%$  of the rated voltage.
- \*2 Select an earth leakage breaker with a sensitivity of leak current of 30 mA. As regards rated current, refer to Applicable Earth Leakage Breaker Capacity on pages 43, 48, 49, 53, 56, and 59.

When using with other voltages than specified for a standard product, use a separately installed power transformer. (page 67)



## IDF/IDU Series

# Specific Product Precautions 2

Be sure to read this before handling the products. For safety instructions and air preparation equipment precautions, refer to the "Handling Precautions for SMC Products" and the "Operation Manual" on the SMC website: <https://www.smcworld.com>

### Air Piping

#### ⚠ Caution

- Be careful to avoid an error in connecting the air piping at the compressed air inlet (IN) and outlet (OUT).
- Install bypass piping since it is needed for maintenance.

Use the bypass piping set on pages 73 and 74.

#### IDF1E to 3E

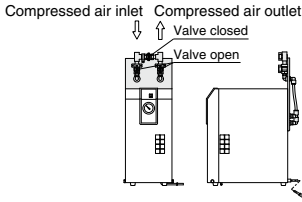

#### IDF4E to 15E1

#### IDU3E to 15E1

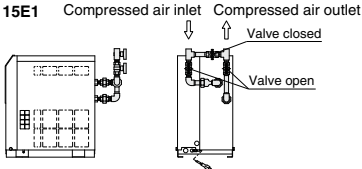

#### IDU22E to 75E

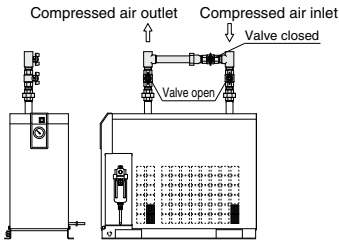

- When tightening the inlet/outlet air piping, firmly hold the hexagonal parts of the port on the air dryer side or piping with a wrench or adjustable angle wrench.
- Variations in operating conditions may cause condensation to form on the surface of the outlet piping. Apply thermal insulation around the piping to prevent condensation from forming.
- Confirm that vibrations resulting from the compressor are not transmitted through the air piping to the air dryer.
- Do not allow the weight of the piping to lie directly on the air dryer.
- If a metallic flexible tubing is used for the inlet/outlet air piping, abnormal noise might be generated in the piping. In that case, please change it to the steel tubing.

### Protection Circuit

#### ⚠ Caution

When the air dryer is operated in the following cases, the protection circuit will activate, the light will turn off and the air dryer will come to stop.

- The compressed air temperature is too high.
- The compressed air flow rate is too high.
- The ambient temperature is too high. (40°C or higher (IDF100F to 150F: 45°C or higher))
- The fluctuation of the power supply voltage is beyond  $\pm 10\%$  of the rated voltage.
- The air dryer is drawing in high temperature air exhausted from an air compressor or other dryer.
- The ventilation grille is obstructed by a wall or clogged with dust.

### Transportation and Installation

#### ⚠ Warning

Be sure to follow the instructions below for transporting the product.

- The product is filled with refrigerant. Transport it (by land, sea or air) in accordance with laws and regulations specified.
- When carrying the product, be careful not to let it drop or fall over. Lift it by using a forklift or rope and lifting hook. The lifting angle should be 45° or more.

- Note) The lifting hooks are installed on the IDF100F to 150F.
- Do not lift the product by holding the panel, fittings or piping.
  - Never lay the product down for transportation. This may lead to damage to the product.

- The product is heavy and has potential dangers in transportation. Be sure to follow the instructions above.
- Be sure to use a forklift or lifting hook for transporting the product.

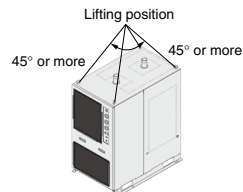



## IDF/IDU Series

# Specific Product Precautions 3

Be sure to read this before handling the products. For safety instructions and air preparation equipment precautions, refer to the "Handling Precautions for SMC Products" and the "Operation Manual" on the SMC website: <https://www.smcworld.com>

### Compressor Air Delivery

#### ⚠ Caution

Use an air compressor with an air delivery of 100 L/min or more for a model other than the IDF1E.

Since the auto drain of the IDF2E to 15E1, IDU3E to 75E is designed in such a way that the valve remains open unless the air pressure rises to 0.1 MPa or higher, air will blow out from the drain outlet at the time of air compressor start up until the pressure increases. Therefore, if an air compressor has a small air delivery, the pressure may not be sufficient.

### Auto Drain

#### ⚠ Caution

The auto drain may not function properly, depending on the quality of the compressed air. Check the operation once a day.

### Cleaning of Ventilation Area (Air-cooled)

#### ⚠ Caution

Remove dust from the ventilation area once a month using a vacuum cleaner or an air blow nozzle.

### Time Delay for Restarting

#### ⚠ Caution

- Allow at least three minutes before restarting the air dryer. Otherwise, the protection circuit will activate, the light will turn off and the air dryer will not start up.
- The residual drainage in the air dryer may splash over the outlet when the operation is re-started, so it is recommended to install a filter on the outlet of the air dryer.

### Modifying the Standard Specifications

#### ⚠ Caution

Do not modify the standard product using any of the optional specifications once the product has been supplied to a customer. Check the specifications carefully before selecting an air dryer. In addition, do not disassemble or modify the product. Products which have been disassembled and/or modified cannot be guaranteed.

### Facility Water Supply (Water-cooled)

#### ⚠ Warning

##### 1. Be certain to supply the facility water.

- Prohibition of water-cut operation, very little flow rate of water operation.

Do not operate under the condition that there is no facility water or where there is very little flow rate of water is flowing. In this kind of operation, facility water temperature may become extremely higher. It is dangerous enough the material of hose may soften and burst when the piping supplying the facility water is connected with hose.

- Actions to be taken when an emergency stop occurs due to high temperature.

In case a stop occurs due to extremely high temperature resulting from a decrease in the facility water flow rate, do not immediately flow facility water. It is dangerous enough the material of hose may soften and burst when the piping supplying the facility water is connected with hose.

First, naturally let it cool down by removing the cause of the flow rate reduction. Secondly, confirm that there is no leakage again.

#### ⚠ Caution

##### 1. Facility water quality

- Use the facility water within the specified range as shown below. When using with other fluids than facility water, please consult with SMC.
- When it is likely that foreign matter may enter the fluid, install a filter (20 mesh or equivalent).

#### <Facility Water Quality Standard>

The Japan Refrigeration and Air Conditioning Industry Association JRA GL-02-1994 "Cooling water system - Circulation type - Circulating water"

	Item	Unit	Standard value
Standard item	pH (at 25°C)	—	6.5 to 8.2
	Electric conductivity (25°C)	[μS/cm]	100 <sup>*1</sup> to 800 <sup>*1</sup>
	Chloride ion (Cl <sup>-</sup> )	[mg/L]	200 or less
	Sulfuric acid ion (SO <sub>4</sub> <sup>2-</sup> )	[mg/L]	200 or less
	Acid consumption amount (at pH4.8)	[mg/L]	100 or less
	Total hardness	[mg/L]	200 or less
Reference item	Calcium hardness (CaCO <sub>3</sub> )	[mg/L]	150 or less
	Ionic state silica (SiO <sub>2</sub> )	[mg/L]	50 or less
	Iron (Fe)	[mg/L]	1.0 or less
	Copper (Cu)	[mg/L]	0.3 or less
	Sulfide ion (S <sub>2</sub> <sup>-</sup> )	[mg/L]	Should not be detected.
	Ammonium ion (NH <sub>4</sub> <sup>+</sup> )	[mg/L]	1.0 or less
	Residual chlorine (Cl)	[mg/L]	0.3 or less
	Free carbon (CO <sub>2</sub> )	[mg/L]	4.0 or less

\*1 In the case of [M2-cm], it will be 0.00125 to 0.01.

### Refrigerant with GWP Reference

Refrigerant	Global Warming Potential (GWP)		
	Regulation (EU) No 517/2014 (Based on the IPCC AR4)	Fluorocarbon Emissions Control Act (Japan) GWP value labeled on products	GWP value to be used for reporting the calculated amount of leakage
R134a	1430	1430	1300
R404A	3922	3920	3940
R407C	1774	1770	1620
R410A	2088	2090	1920

\* This product is hermetically sealed and contains fluorinated greenhouse gases (HFC). When this product is sold on the market in the EU after January 1, 2017, it needs to be compliant with the quota system of the F-Gas Regulation in the EU.

\* See specification table for refrigerant used in the product.