

Refrigerated Air Dryer

IDF100FS/125FS/150FS Series

Double energy saving function series

Second re-heater

Digital scroll compressor

Stainless steel heat exchanger

Ozone depletion potential **ZERO** refrigerant

RoHS

Saves energy by up to 76%
by using second re-heater and digital scroll compressor!!

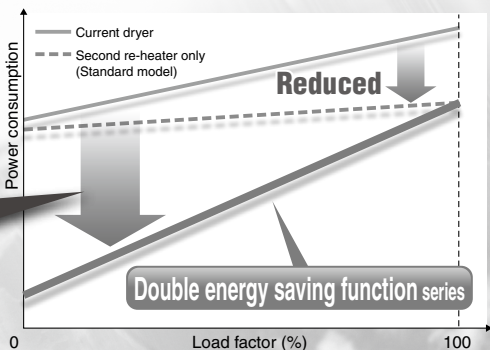

Energy saving design

By up to **76%** Power consumption (1 kW)^{*1} reduced

*1. Operating conditions: The IDF125FS operated in the energy saving operation mode
 ● Ambient temperature 32°C ● Inlet air temperature 40°C
 ● Inlet air pressure 0.7 MPa ● Air flow rate = Rated flow x 0.4
 ● Power supply frequency 60 Hz ● Power supply voltage 200 V ● Set dew point = 30°C

By up to **25%** Exhaust heat reduced^{*2}

*2. Under the rated conditions



Tolerant of high temperature environment!

- Ambient temperature : Up to 45°C
- Inlet air temperature : Up to 60°C

ECO switch

Optimal operation by switching between the energy saving operation mode and the normal operation mode depending on the season and operating environment

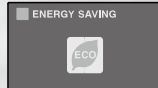

* Refer to page 99 for details.

Applicable air compressor **100 kW/125 kW/150 kW**

Refrigerated Air Dryer

Energy saving effects of the double energy

Energy saving design

Second re-heater

Second re-heater

Digital scroll compressor

Digital scroll compressor

Double energy saving function series reduces power consumption

by up to **76%!**

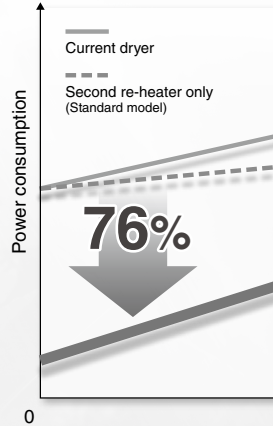

Operating conditions: The ID125FS operated in the energy saving operation mode

● Ambient temperature 32°C ● Inlet air temperature 40°C ● Inlet air pressure 0.7 MPa ● Air flow rate = Rated flow x 0.4 ● Power supply frequency 60 Hz ● Power supply voltage 200 V ● Set dew point = 30°C

Second re-heater

Energy saving effect of the second re-heater

Exhaust heat from dryer

By up to **25% reduced** (SMC comparison)

Condition: The ID100FS is operated with the rated condition of 60 Hz.

Effective for downsizing and energy saving operation of the air conditioner!

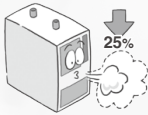

Exhaust heat from dryer

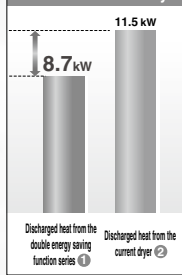

Ambient temperature

45°C

Second re-heater helps heat discharge from the condenser!

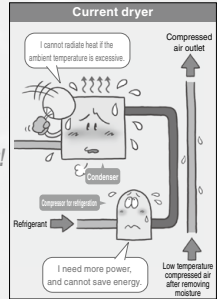

Suppresses ambient temperature increase

Second re-heater reduces heat discharge from the dryer by up to 25% (SMC comparison) by reducing the load to the condenser, and this suppresses ambient temperature increase.

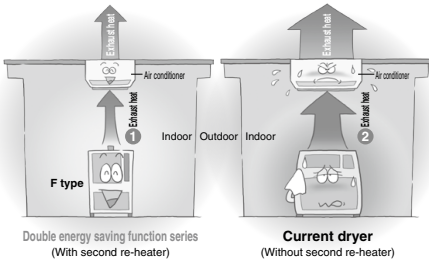

Double energy saving function series

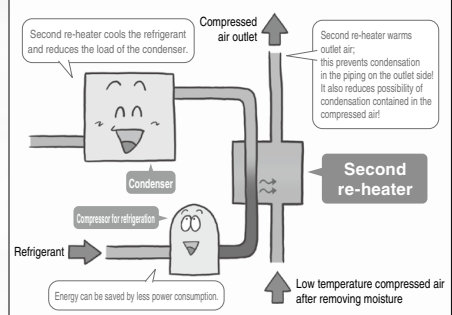

saving function series

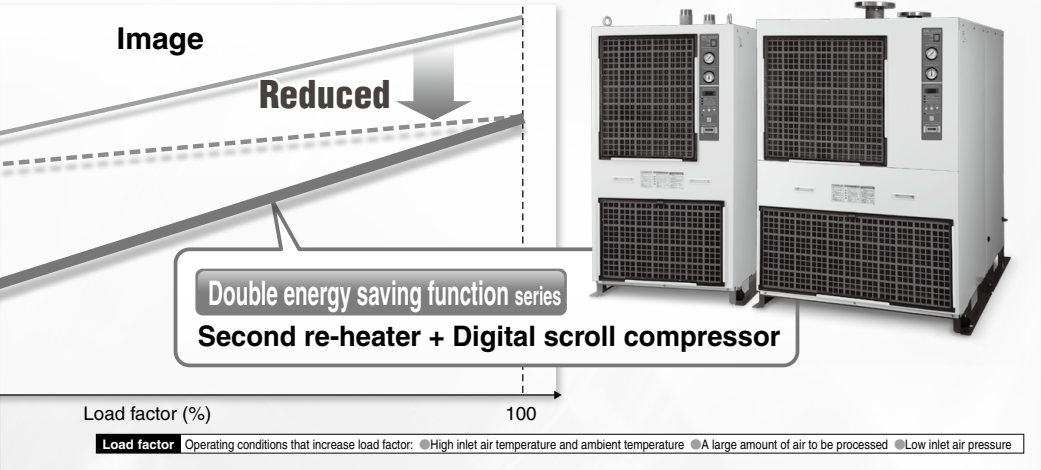

Digital scroll compressor Difference in the energy saving efficiency between different kinds of compressors

Double energy saving function series

controls the compressor output depending on the load factor.

Reduces power consumption of the dryer!

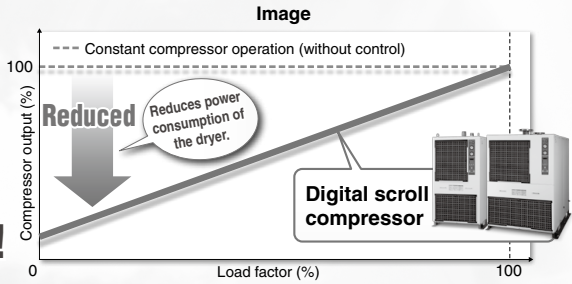

Load factor Operating conditions that increase load factor: ● High inlet air temperature and ambient temperature ● A large amount of air to be processed ● Low inlet air pressure

Output control method of the compressor (with load factor 50%)

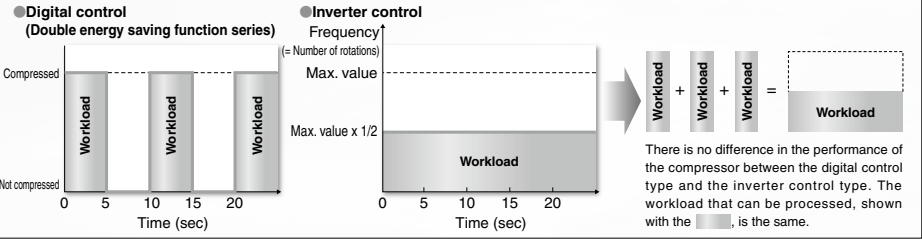

Digital control Digital scroll compressor, which has the unloading function, controls the compressor output depending on the load by repeating compression and no-compression as shown in the figure above. By automatically changing the compression/no-compression time, it is possible to change the dehumidification capacity (cooling capacity) of the dryer.

Refrigerated Air Dryer

Effect example 1 year (Spring to Winter) Power consumption Reduced



Compared with the standard model (constant compressor operation),

double energy saving function series

reduces power consumption by 43%!! (Note)

(Note) The IDF125FS is used for this example.

Double energy saving function series (IDF125FS)

Standard model (IDF125F)

(Note) [Trial calculation conditions] Days of operation per year = 240 days (60 days each in spring, summer, autumn and winter), Operation hours per day = 12 hours, Operating conditions = Refer to the conditions shown below.

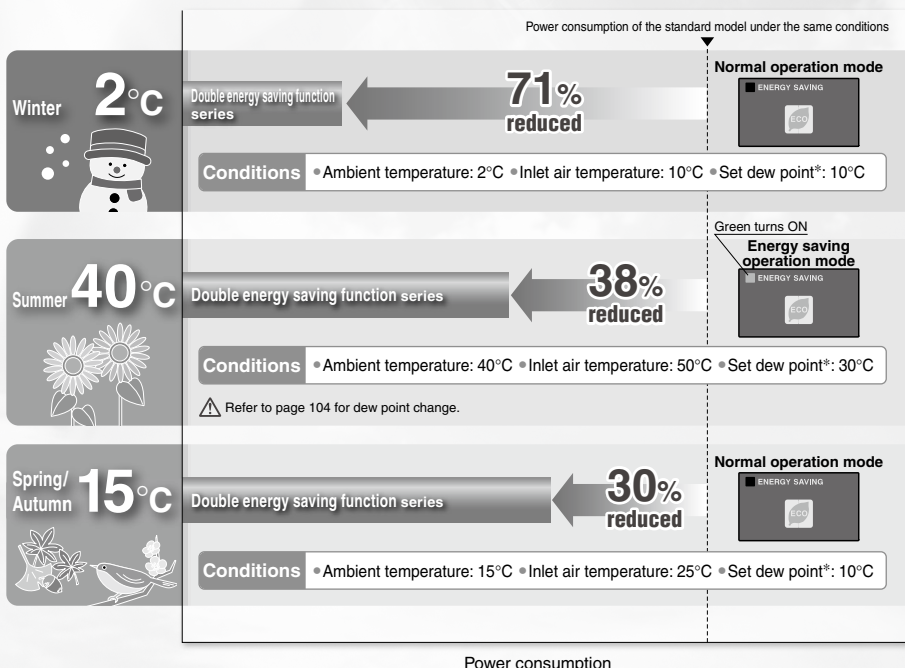

Common conditions

• Air flow rate = Rated flow • Inlet air pressure: 0.5 MPa • Power supply frequency: 60 Hz • Power supply voltage: 200 V

* Dew point can be set for the double energy saving function series only. The dew point setting function is not equipped with the standard model.

Convenient functions

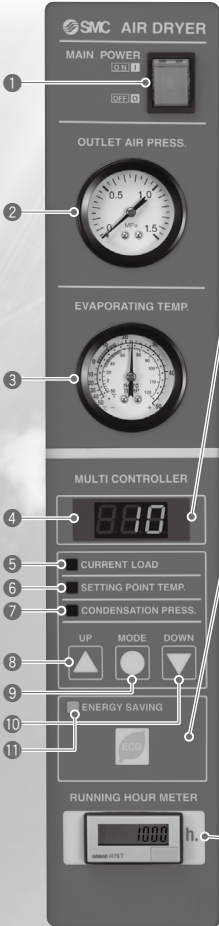

Clear digital display (This displays the operation factor (dryer output) as an example.)

Easy-to-see LED even in a dark place
Fault diagnosis with alarm codes

Example **E02** Fan motor failure



Alarm code	Alarm name	Operation	Main cause
E00	Abnormal phase	Stop	Phase sequence reversal or open phase
E01	Thermal trip	Stop	Clogging of the dust filter, overload, or compressor failure
E02	Fan motor failure	Stop	Fan motor failure
E03	Compression pressure failure	Stop	Clogging of the dust filter or overload
e00	Compression pressure warning	Continue	Clogging of the dust filter or overload

ECO switch

Operation mode can be set either in the energy saving operation mode^{*1} or normal operation mode^{*2} by using the ECO (economical mode) switch. In the energy saving operation mode, changing the set dew point can save more energy.

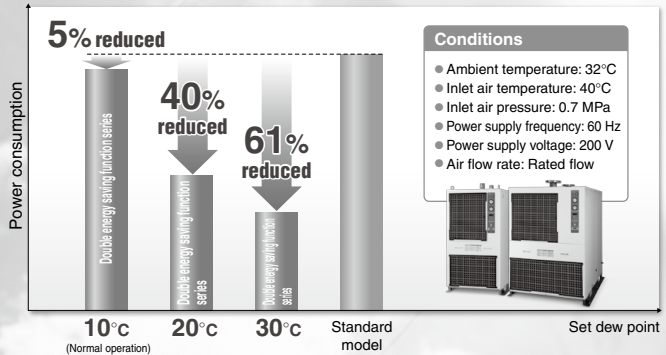

Accumulated running hours display

Helps maintenance control of the dryer.
Gives notice of the maintenance timing etc.

*1. Energy saving operation (ECO LED is ON green): Dew point can be set manually between 10 to 30°C.
*2. Normal operation (ECO LED is OFF): Dew point is fixed to 10°C.

No.	Description	Function
①	Illuminated switch	Operate or stop the dryer. Green LED turns ON during operation.
②	Air pressure gauge	Displays air pressure inside the heat exchanger.
③	Evaporation thermometer	Displays evaporating temperature of refrigerant.
④	Multi-display	Displays operation factor (output) of the dryer, set dew point, condensation pressure, or alarm code.
⑤	Operation factor LED	The dryer output is displayed on the multi-display while this LED is ON.
⑥	Set dew point LED	The set dew point is displayed on the multi-display while this LED is ON.
⑦	Condensation pressure LED	The condensation pressure of the refrigerant is displayed on the multi-display while this LED is ON.
⑧	UP key	Increase the set dew point.
⑨	MODE key	Pressing this key changes the display on the multi-display in sequence from operation factor, set dew point, condensation pressure, and back to operation factor.
⑩	DOWN key	Decrease the set dew point.
⑪	ECO LED	Operate in the energy saving mode while this LED is ON green.

Maintenance

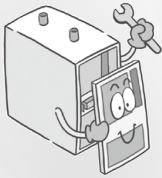

- Reduces maintenance hours by using a stainless steel heat exchanger with higher corrosion resistance.
- Dustproof filter
- Only access from front side is required to check electrical equipment and dustproof filter.

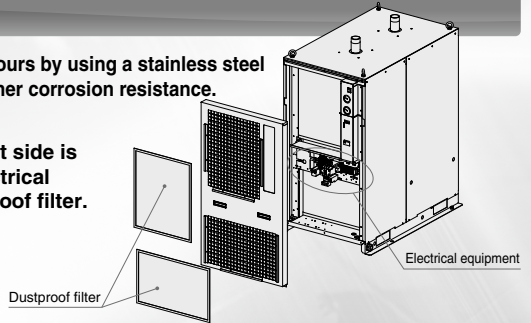

Selection of layout

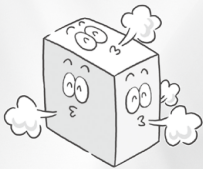

- Exhausting direction can be selected from four directions!!
- Auto drain tube can be connected in two directions, left or right.

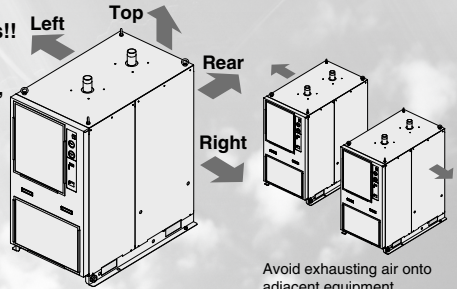

Space saving

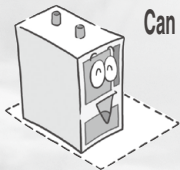

Can be installed flat against a wall*1!

*1: One side only (either left or right)

- Exhausting direction can be selected from four directions!! (Rear, right, left, and top)
- Main maintenance can be performed on the front and rear sides.

Leave at least 600 mm on the sides indicated with \longleftrightarrow .

Note) Leave a space of at least 600 mm between the heat exhausting face and the wall.

Installation space reduced by up to 1.5 m²

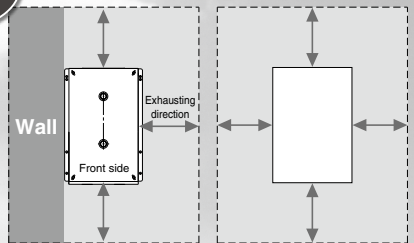

Installation space of the IDF100FS (Example of heat exhausting direction from right side)

Installation space of the current type

IDF100FS/125FS/150FS Series Model Selection

The corrected air flow capacity, which considers the user's operating conditions, is required for selecting air dryer. Select using the following procedures.

1 Read the correction factors.

Obtain the correction factors **A** to **D** suitable for your operating condition from the table on the next page.

IDF100FS/125FS/150FS Selection Example

Conditions		Data symbol	Correction factor ^(Note)
Inlet air temperature	45°C	A	0.92
Ambient temperature	40°C	B	0.98
Outlet air pressure dew point	10°C	C	1
Inlet air pressure	0.5 MPa	D	0.93
Air flow rate	12 m ³ /min	—	—
Power supply frequency	50 Hz	—	—

Note) Values obtained from "Correction Factors" below.

2 Check the coefficient.

Correction factor = 0.92 x 0.98 x 1 x 0.93 = 0.84

Max. coefficient value is 1.5. Correction factor is 1.5 when the calculation result is 1.5 or greater.

3 Calculate the corrected air flow capacity.

Obtain the corrected air flow capacity from the following formula.

Corrected air flow capacity = Air flow rate ÷
(Correction factor **A** x **B** x **C** x **D**)

Corrected air flow capacity = 12 m³/min ÷ (0.92 x 0.98 x 1 x 0.93)
= 14.3 m³/min

4 Select the model.

Select the model with air flow capacity which exceeds the corrected air flow capacity from the specification table. (For air flow capacity, refer to the Data **E** below.)

According to the corrected air flow capacity of 14.3 m³/min, the **IDF100FS** will be selected which air flow capacity is 16 m³/min at 50 Hz.

5 Options

Refer to page 100.

6 Finalize the model number.

Refer to page 103.

7 Select the optional accessories.

Refer to page 111.

Correction Factors

Data **A**: Inlet Air Temperature

Inlet air temp. (°C)	Correction factor
5 to 30	1.41
35	1.21
40	1
45	0.92
50	0.75
55	0.63
60	0.53

Data **C**: Outlet Air Pressure Dew Point

Outlet air pressure dew point (°C)	Correction factor
10	1
15	1.4
16 or more	1.5*

* The maximum coefficient value is 1.5 due to the drainage separation performance.

Data **E**: Air Flow Capacity

Model		IDF100FS	IDF125FS	IDF150FS
		Air flow capacity m ³ /min (ANR)	50 Hz	16
	60 Hz	18.8	23.7	27

Data **B**: Ambient Temperature

Ambient temp. (°C)	Correction factor
2 to 25	1.06
30	1.02
32	1
35	0.99
40	0.98
45	0.92

Data **D**: Inlet Air Pressure

Inlet air pressure (MPa)	Correction factor
0.2	0.84
0.3	0.87
0.4	0.9
0.5	0.93
0.6	0.96
0.7	1
0.8	1.03
0.9	1.06
1 to 1.6	1.09

Refrigerant R407C (HFC)

IDF100FS/125FS/150FS Series

Applicable Compressor Size: 100 kW, 125 kW, 150 kW
(Max. inlet air temperature: 60°C, Max. ambient temperature: 45°C)



How to Order

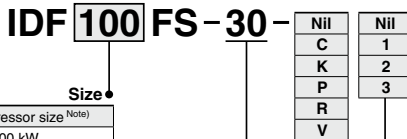

Size

Size	Air compressor size ^{Note)}
100	100 kW
125	125 kW
150	150 kW

Note) Note that the above values are for reference only. Check the actual compressor capacity.

Voltage

Symbol	Voltage
30	Three-phase 200 VAC (50 Hz) 200/220 VAC (60 Hz)

Heat exhausting direction

Symbol	Description
Nil	Heat exhaust from the rear
1	Heat exhaust from the right ^{Note)}
2	Heat exhaust from the left ^{Note)}
3	Heat exhaust from the top ^{Note)}

Note) The combination of 1, 2 and 3 is not available. (Heat exhausting face can be specified on one side only.)

Options

Symbol ^{Note)}	Description
Nil	None
C	Anti-corrosive treatment for copper tube
K	Moderate pressure specification
P	With a metal name plate
R	With an earth leakage breaker
V	With a timer controlled solenoid valve type auto drain

Note) Enter alphabetically when multiple options are combined.

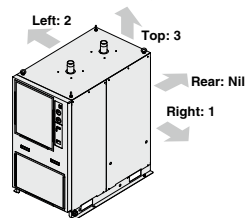

IDF100FS/125FS/150FS Series



Symbol

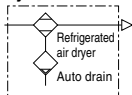

△ Outlet air pressure dew point set range

When setting the dew point of outlet air pressure, it should be set to a lower temperature than the ambient temperature of the downstream piping of the dryer. If the dew point is set at a higher temperature than the ambient temperature, the dehumidified compressed air at the outlet of the dryer will be cooled down, and moisture in the compressed air condenses, resulting in a failure of the pneumatic equipment on the downstream side of the dryer or splashing of the condensation over the workpieces.

When there is a possibility of such risks due to ambient temperature change etc., a compact dryer or filter for removing water droplets should be installed.

When changing the set dew point, the following points should be noted.

- Temperature change due to season change
- Outside temperature between compressor room and facility
- Manufacturing site that is locally cooled

△ Product specifications

Please refer to the "Product Specifications" that is available separately for utility. Please contact SMC sales representative for the "Product Specifications".

Standard Specifications

Item	Model	IDF100FS-30	IDF125FS-30	IDF150FS-30	
Operating range					
Fluid					
Compressed air					
Inlet air temperature (°C)					
5 to 60					
Inlet air pressure (MPa)					
0.15 to 1.0/0.15 to 1.6 (Option K)					
Ambient temperature (humidity) (°C)					
2 to 45 (Relative humidity 85% or less)					
Outlet air pressure dew point set range (Note 2) (Note 3) (°C)					
10 to 30					
Rated conditions					
Air flow capacity (m ³ /min)	Standard condition (ANR) (Note 4)	50 Hz	16	20.1	25
	Compressor intake condition (Note 5)	60 Hz	18.8	23.7	27
		50 Hz	16.7	20.9	26
		60 Hz	19.6	24.7	28.1
Inlet air pressure (MPa)					
0.7					
Inlet air temperature (°C)					
40					
Ambient temperature (°C)					
32					
Outlet air pressure dew point (Note 6) (°C)					
10					
Exhaust heat from condenser (50/60 Hz) (kW)					
7.5/8.7 9.2/10.8 10.4/12.4					
Energy efficiency					
Power supply voltage (Frequency) (Note 7)					
Three-phase 200 VAC (50 Hz)/200, 220 VAC (60 Hz)					
Power consumption (50/60 Hz) (Note 8) (kW)					
2.8/3.3 3.8/4.5 3.8/4.5					
Operating current (50/60 Hz) (Note 8) (A)					
8.9/9.9 13.0/14.5 13.0/14.5					
Applicable earth leakage breaker capacity (Note 9) (A)					
20 30					
Condenser					
Air-cooled					
Refrigerant					
R407C (HFC)					
Refrigerant charge (kg)					
1.38 1.46 1.98					
Auto drain					
Heavy duty auto drain (Normally open)					
Port size					
R2 JIS flange 65A 10K JIS flange 80A 10K					
Weight (kg)					
228 255 340					
Applicable air compressor output (Reference) For screw type (kW)					
100 125 150					

Note 1) The operation range does not guarantee the use with normal air flow capacity. When operating conditions are different from the rated specifications, please select a model in accordance with Model Selection on page 102.

Note 2) This function is used to reduce the energy consumption of the dryer operation by changing the outlet air pressure dew point depending on the season and operating environment.

As this is not a function for the purpose of setting the dew point of the outlet air pressure to the required dew point, SMC does not warrant the offset and stability of the dew point of the outlet air pressure.

Note 3) It is not possible to set the dew point of the outlet air pressure higher than the dew point of the inlet air pressure. (This dryer does not have a humidifying function.) When the load (e.g. air flow rate, inlet air temperature) is small, dew point of the outlet air pressure may be lower than the set dew point. When the load is large, dew point of the outlet air pressure may not decrease to the set dew point.

Note 4) Air flow capacity under the standard condition (ANR) [at 20°C, atmospheric pressure, relative humidity 65%]

Note 5) Air flow capacity converted by the compressor intake condition [at 32°C, atmospheric pressure]

Note 6) Dew point of the outlet air pressure shown in this table is the value that is obtained when the air flow rate, inlet air temperature, inlet air pressure and ambient temperature are stable. The stated dew point of the outlet air pressure may not be obtained in an unstable condition, such as soon after compressed air is supplied.

Note 7) The voltage fluctuation should be maintained within $\pm 10\%$ of the rated voltage.

Note 8) Value with the power supply voltage 200 V

Note 9) Install an earth leakage breaker with a sensitivity 30 mA.

Replacement Parts

Air dryer model	IDF100FS	IDF125FS	IDF150FS
Heavy duty auto drain replacement part no. (Note 10)	ADH-E400		
Dustproof filter set for condenser	IDF-FL219	IDF-FL220	

Note 10) Part number of only the exhaust mechanism replacement kit excluding the housing

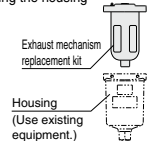

Construction (Air/Refrigerant Circuit)

Hot and humid air entering the air dryer is cooled down by the cooler re-heater (heat exchanger). The moisture which is condensed and separated is automatically exhausted by the auto drain. The air which has had its moisture removed is heated in two stages by the re-heater (heat exchanger) in the cooler re-heater and by the second re-heater, and is supplied to the outlet side as warm and dry air.

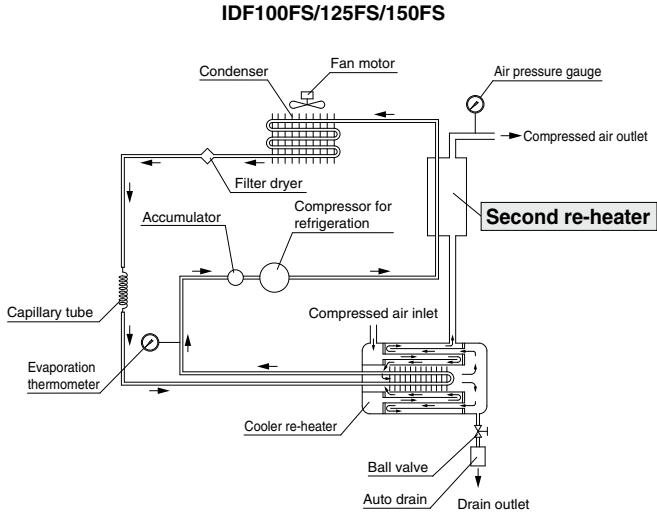

Second re-heater

Compressed air from which drainage has been exhausted exchanges heat with refrigerant which has been compressed by the refrigerator, to give the following effects:

1. The outlet air temperature increases, preventing condensation of the piping on the outlet side.
2. The amount of heat exhausted from the condenser is reduced.
3. Energy saving operation of the dryer is achieved by reducing the amount of heat exhausted from the condenser.

IDF100FS/125FS/150FS Series

Dimensions

IDF100FS

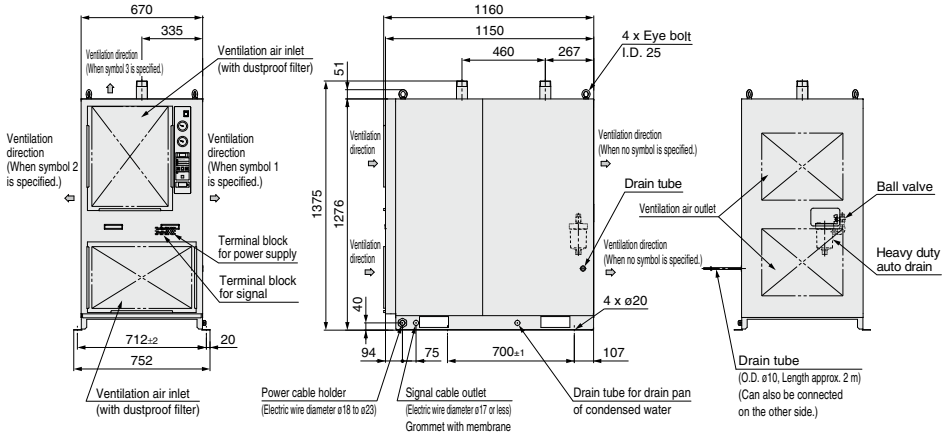

Top view

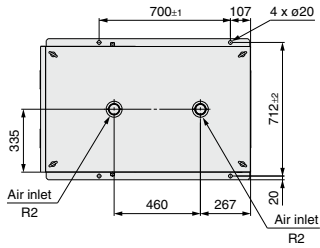

Refrigerated Air Dryer **IDF100FS/125FS/150FS Series**

Dimensions

IDF125FS/150FS

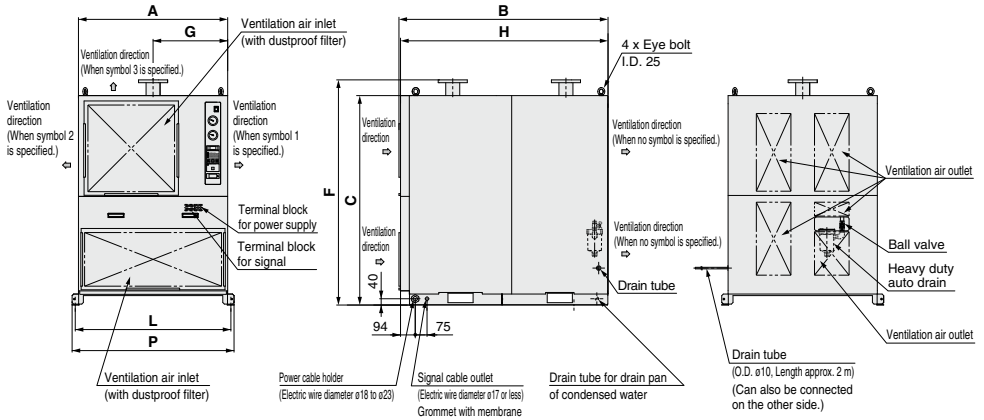

Top view

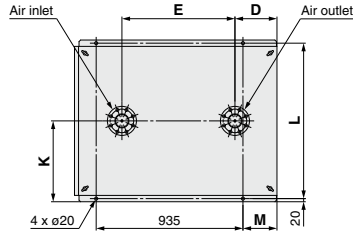

Dimensions

Model	Port size	A	B	C	D	E	F	G	H	K	L	M	P
IDF125FS	JIS flange 65A 10K	700	1160	1276	267	655	1375	350	1150	376	712	78	752
IDF150FS	JIS flange 80A 10K	950	1330	1332	268	720	1432	475	1320	515	990	217	1030

(mm)

IDF100FS/125FS/150FS Series

Slit Dimensions

IDF100FS

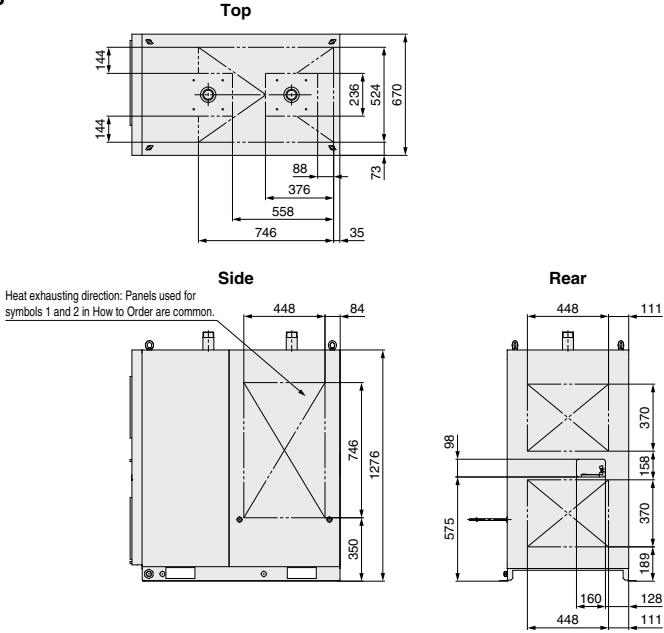

IDF125FS

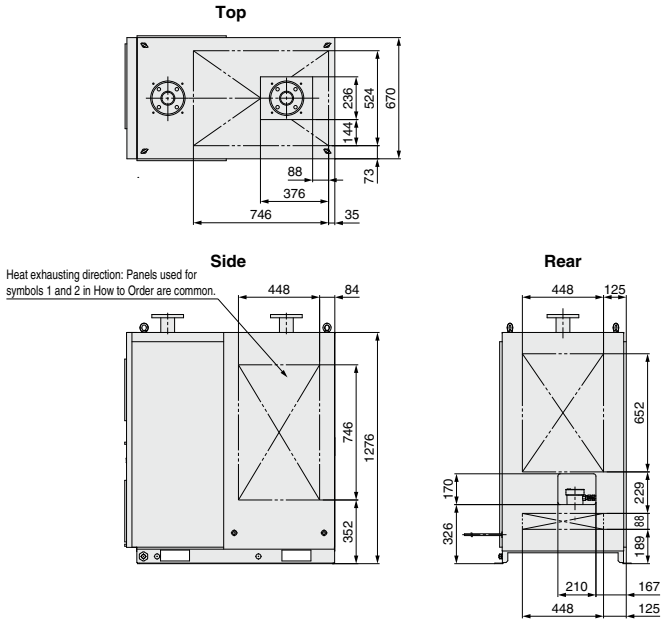

Slit Dimensions

IDF150FS

Top

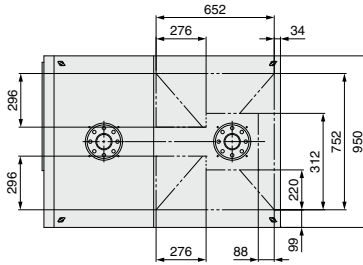

Side

Heat exhausting direction: Panels used for symbols 1 and 2 in How to Order are common.

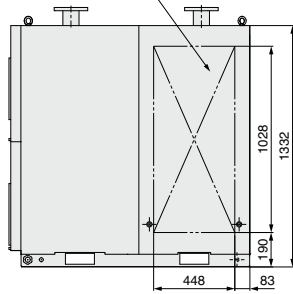

Rear

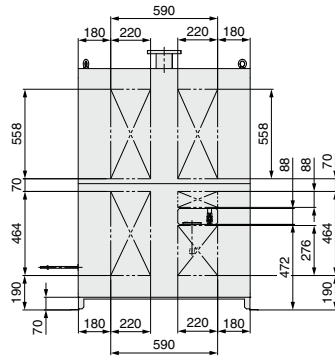

IDF100FS/125FS/150FS Series

Options

Refer to "How to Order" on page 103 for optional models.

C Option symbol

Anti-corrosive treatment for copper tube

This minimizes the corrosion of the copper and copper alloy parts when the air dryer is used in an atmosphere containing hydrogen sulfide or sulfurous acid gas. (Corrosion cannot be completely prevented.)

Special epoxy coating: Copper tube and copper alloy parts

The coating is not applied on the heat exchanger or around electrical parts, where operation may be affected by the coating.

* Corrosion is not covered under warranty.

K Option symbol

Moderate pressure specification

The maximum operating pressure is 1.6 MPa.

The internal drain piping material is changed from nylon to metal.

Specifications

1. Maximum operating pressure: 1.6 MPa
2. Dimensions ... same as standard products

P Option symbol

With a metal name plate

The label identifying the model and specifications of the product is changed to a metal plate which has better endurance.

R Option symbol

With an earth leakage breaker

An earth leakage breaker is installed in the air dryer.

This saves additional electrical wiring at the time of installation.

Air dryer model	IDF100FS-30-R	IDF125FS-30-R IDF150FS-30-R
Breaker capacity	20 A	30 A

Sensitivity current: 30 mA

V Option symbol

With a timer controlled solenoid valve type auto drain



Float type heavy duty auto drain is changed to the solenoid valve type auto drain. Drainage is discharged by controlling a solenoid valve with a timer. A strainer for solenoid valve protection and stop valve are also included.

Replacement Parts

Description	Part no.	Note
Timer type solenoid valve	IDF-S0405	200 VAC

IDF100FS/125FS/150FS Series Optional Accessories

Specifications

Description	Contents	Specifications
Separately installed power transformer *1 	Power supply and voltage for those other than the standard	Max. ambient temperature 40°C (Relative humidity 85% or less)
Foundation bolt set 	For fixing the air dryer to the foundations Easy to secure by striking the axle	Stainless steel
Piping adapter 	For converting the thread type of an IN/OUT fitting for air dryers from Rc to NPT	Copper alloy
Panel for changing heat exhausting direction	For changing the heat exhausting direction of the air-cooled type on site. A slit panel and a panel without slit are used in combination.	Refer to the operation manual for details.

*1 This transformer does not have CE/UKCA marking and is not compliant with UL standards.

Dimensions

[Separately installed power transformer]

This transformer does not have CE/UKCA marking and is not compliant with UL standards.

IDF-TR7000-8

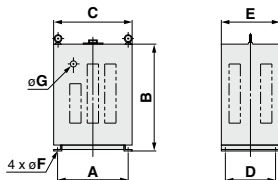

Specifications/Dimensions

Transformer	Applicable dryer	Capacity	Type	Inlet voltage	Outlet voltage	A	B	C	D	E	F	G	Weight
IDF-TR7000-8	IDF100FS	7 kVA	Three-phase	220, 240	200 V (50/60 Hz)	360	540	400	260	300	11	30	94 kg
IDF-TR9000-8	IDF125FS IDF150FS	9 kVA	Compound winding	380, 400, 415 440 V (50/60 Hz)		400	650	450	300	350	13	40	109 kg

(mm)

[Foundation bolt set]

Specifications

Part no.	Applicable dryer	Nominal thread size	Material	Number of 1 set
IDF-AB501	IDF100FS to 150FS	M10	Stainless steel	4

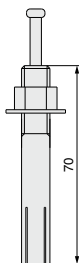

* Use a large flat washer when it is used.
Mounting hole dia.: $\phi 10.5$

[Piping adapter]

IDF-AP607

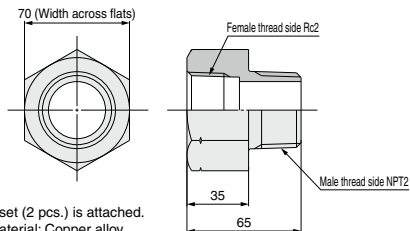

* 1 set (2 pcs.) is attached.
* Material: Copper alloy

IDF100FS/125FS/150FS Series Data

Condensed Water Calculation

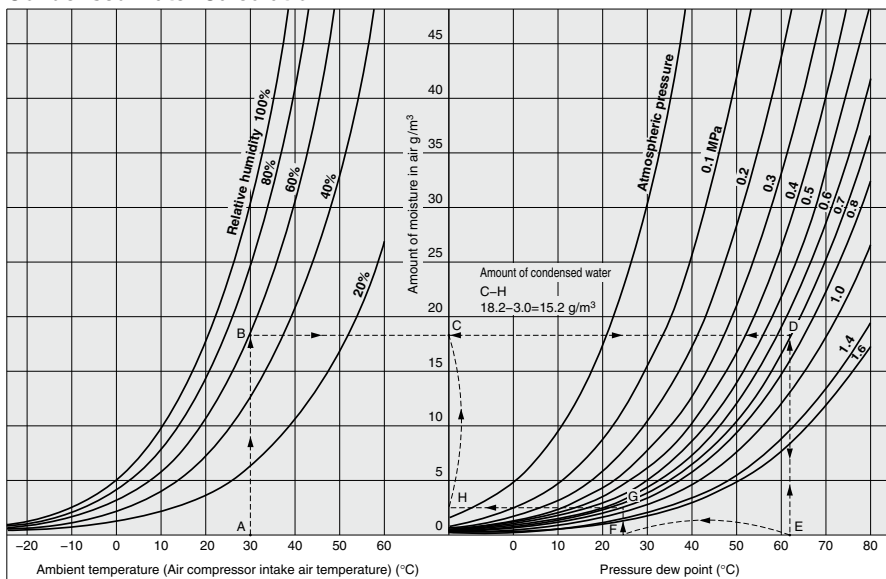

How to calculate the amount of condensed water

Example) To obtain the amount of condensed water when the pressure is applied to air up to 0.7 MPa with an air compressor, then cooled down to 25°C. Given an ambient temperature at 30°C and a relative humidity 60%.

- Trace the arrow mark from the point A at an ambient temperature 30°C to obtain the intersection B on the curved line for the relative humidity 60%.
- Trace the arrow mark from the intersection B to obtain the intersection D on the pressure characteristic line for 0.7 MPa.
- Trace the arrow mark from the intersection D to obtain the intersection E.
- The intersection E is the dew point under pressure 0.7 MPa with an ambient temperature 30°C and a relative humidity 60%. The value for E is 62°C.
- Trace the intersection E upward, and trace from the intersection D leftward to obtain the intersection C.
- The intersection C is the amount of moisture included in the compressed air 1 m³ at 0.7 MPa and a pressure dew point 62°C.

The amount of moisture is 18.2 g/m³.

- Trace the arrow mark, starting from F for cooling temperature 25°C (pressure dew point 25°C) to obtain the intersection G on the pressure characteristic line for 0.7 MPa.
- From the intersection G, trace the arrow mark to obtain the intersection H on the vertical axis.
- The intersection H is the amount of moisture included in the compressed air 1 m³ at 0.7 MPa, and a pressure dew point 25°C.
- The amount of moisture is 3.0 g/m³.**
- Therefore, the amount of condensed water is as follows.

(per 1 m³)
The amount of moisture at the intersection C
- the amount of moisture at the intersection H
= the amount of condensed water
18.2 - 3.0 = 15.2 g/m³

Dew Point Conversion Chart

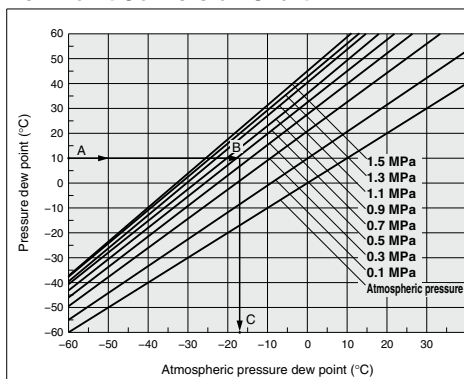

How to read the dew point conversion chart

Example) To obtain the atmospheric pressure dew point at a pressure dew point 10°C and a pressure 0.7 MPa.

- Trace the arrow mark → starting from the point A at a pressure dew point 10°C to obtain the intersection B on the pressure characteristic line for 0.7 MPa.
- Trace the arrow mark → starting from the point B to obtain the intersection C at the dew point under atmospheric pressure.
- The intersection C is the conversion value -17°C under atmospheric pressure dew point.

IDF100FS/125FS/150FS Series Specific Product Precautions 1



Be sure to read this before handling the products. For safety instructions and air preparation equipment precautions, refer to the “Handling Precautions for SMC Products” and the “Operation Manual” on the SMC website: <https://www.smcworld.com>

Installation

⚠ Caution

- Avoid locations where the air dryer will be in direct contact with wind and rain. (Avoid locations where relative humidity is 85% or more.)
- Avoid exposure to direct sunlight.
- Avoid locations that contain much dust, corrosive gases, or flammable gases. Failure due to corrosion is not covered under warranty. However, when the risk of corrosion is high, select the option C (anti-corrosive treatment for copper tube).
- Avoid locations of poor ventilation and high temperature.
- Avoid locations where the air dryer is too close to a wall etc. Leave a sufficient space between the air dryer and the wall according to the “Maintenance Space” in the operation manual.
- Avoid locations where the air dryer could draw in high temperature air discharged from an air compressor or other dryer.

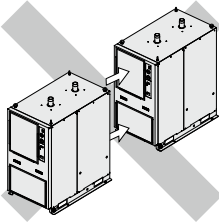

Check that the exhaust air does not flow into the neighboring equipment.

- Avoid locations subjected to vibration.
- Avoid possible locations where the drain can freeze.
- Avoid locations with an ambient temperature over 45°C.
- Avoid installation on machines for transporting, such as vehicles, ships, etc.
- Avoid locations which experience sudden pressure/flow rate changes.

Drain Tube

⚠ Caution

- A polyurethane tube is attached as a drain tube for this product. Use this tube to discharge drainage to a drain tank etc.
- Do not use the drain tube in an upward direction. Do not bend or crush the drain tube. (Operation of the auto drain will stop water vapor from discharging through the air outlet.) If it is unavoidable that the tube goes upward, make sure it only goes as far as the position of the auto drain.
- The drain tube comes with a tube fitting. Pipe a 10 mm O.D. tube with a length of 5 m or less.

Power Supply

⚠ Caution

<200 VAC>

- Connect the power supply to the terminal block.
 - Install an earth leakage breaker ^(Note) suitable to each model for the power supply.
 - Maintain voltage fluctuation within $\pm 10\%$ of the rated voltage.
- Note) Select an earth leakage breaker with a sensitivity current of 30 mA. As regards rated current, refer to “Applicable earth leakage breaker capacity” on page 104.

When the voltage is different from the standard specifications, use a separately installed power transformer on page 111.

Air Piping

⚠ Caution

- Be careful to avoid an error in connecting the air piping at the compressed air inlet (IN) and outlet (OUT).
- Install bypass piping since it is needed for maintenance.
- When tightening the inlet/outlet air piping, hold the dryer-side piping firmly in place with a pipe wrench.
- The piping surface may reach temperatures around 60°C depending on usage conditions. When adjusting valves or performing other such operations, a temperature check is necessary, wear gloves before proceeding.
- Check that vibrations resulting from the compressor are not transmitted through the air piping to the air dryer.
- Do not allow the weight of the piping to lie directly on the air dryer.

Protection Circuit

⚠ Caution

When the air dryer is operated in the following cases, which will activate the protection circuit and turn off the lamp, the air dryer will come to stop.

- The compressed air temperature is too high.
- The compressed air flow rate is too high.
- The ambient temperature is too high. (over 45°C)
- The fluctuation of the power supply is beyond the rated voltage $\pm 10\%$.
- The air dryer is drawing in high temperature air that is exhausted from an air compressor or other dryer.
- The ventilation port is obstructed by a wall or clogged with dust.

Transportation and Installation

⚠ Warning

Be sure to follow the below instructions for transporting the product.

- The product is filled with refrigerant. Transport it (by land, sea or air) in accordance with laws and regulations specified.
- When carrying the product, be careful not to let it drop or fall over. Lift it by using a fork lift or rope and lifting hook. The lifting angle should be 45° or more.
- Do not lift the product by holding the panel, fittings or piping.
- Never lay the product down for transportation. This may lead to damage to the product.
- The product is heavy and has potential dangers in transportation. Be sure to follow the above instructions.
- Be sure to use a fork lift or lifting hook for transporting the product.

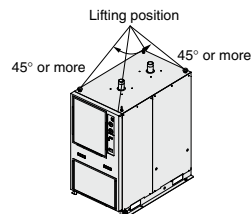



IDF100FS/125FS/150FS Series

Specific Product Precautions 2

Be sure to read this before handling the products. For safety instructions and air preparation equipment precautions, refer to the “Handling Precautions for SMC Products” and the “Operation Manual” on the SMC website: <https://www.smcworld.com>

Compressor Air Delivery

Caution

Use an air compressor with an air delivery of 50 L/min or larger.

Since the auto drain is designed in such a way that the valve remains open unless the air pressure rises to 0.05 MPa or higher, air will blow out from the drain outlet at the time of air compressor start up until the pressure increases. Therefore, if an air compressor has a small air delivery, the pressure may not be sufficient.

Auto Drain

Caution

The auto drain may not function properly, depending on the quality of the compressed air. Check the operation once a day.

Cleaning of Ventilation Area

Caution

Remove dust from the ventilation area once a month using a vacuum cleaner or an air blow nozzle.

Delay for Restarting

Caution

- Allow at least three minutes before restarting the air dryer. Otherwise, the protection circuit will activate, the lamp will be turned off and the air dryer will not start up.
- The residual drainage in the air dryer may splash over the outlet when the operation is re-started, so it is recommended to install a filter on the outlet of the air dryer.

Modifying the Standard Specifications

Caution

The heat exhausting direction of the air dryer can be changed using the “panel for changing heat exhausting direction” which is sold separately. Refer to the operation manual.

The other optional specifications cannot be modified once the product has been supplied to a customer. Check the specifications carefully before selecting an air dryer.

■ Refrigerant with GWP reference

Refrigerant	Global Warming Potential (GWP)		
	Regulation (EU) No 517/2014 (Based on the IPCC AR4)	Fluorocarbon Emissions Control Act (Japan) GWP value labeled on products	GWP value to be used for reporting the calculated amount of leakage
R134a	1,430	1,430	1,300
R404A	3,922	3,920	3,940
R407C	1,774	1,770	1,620
R410A	2,088	2,090	1,920

Note 1) This product is hermetically sealed and contains fluorinated greenhouse gases (HFC). When this product is sold on the market in the EU after January 1, 2017, it needs to be compliant with the quota system of the F-Gas Regulation in the EU.

Note 2) See specification table for refrigerant used in the product.