

Stopper Cylinder

RSQ Series (Fixed mounting height)

RSG Series (Adjustable mounting height)

ø12, ø16, ø20, ø32, ø40, ø50 ø40, ø50

Realize labor saving and automation of conveyor line

A through-hole type and a both ends tapped type are available.
RSQ series (Fixed mounting height type)
 ø12, ø16, ø20, ø32, ø40, ø50

Mounting position can be adjusted arbitrarily by changing the attached flange height.
RSG series (Adjustable mounting height type)
 ø40, ø50

Numerous variations

It is possible to select option for many applications.
 Type: Fixed mounting height (RSQ), Adjustable mounting height (RSG)
 Action: Double acting, Single acting (Spring extend), Double acting with spring
 Rod end configuration: Round bar type, Round bar with female rod end, Chamfered type, Chamfered with female rod end, Roller type, Lever type
 Mounting: Through-hole, Both ends tapped (RSQ)
 Flange: (RSG)

Equipped with an easy-to-maintain shock absorber.

The shock absorber incorporated in the lever type is adjustment-free and easy-to-maintain. (ø32, ø40, ø50)

Auto switch option available

Compact auto switch mounting to enable miniaturization of machines and designs.

Lever type selected according to applications

- Prevention of repulsion by light pallets...Locking mechanism
- Partial passing of work.....With cancel



Lock Mechanism

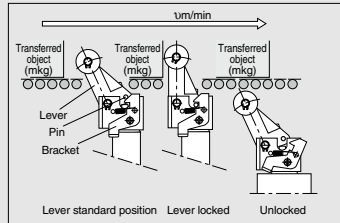

Cancel Cap (Mechanism to hold lever horizontally)

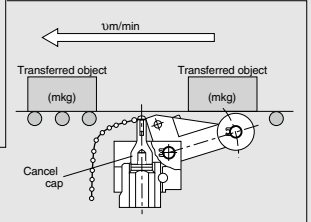

Series Variations

Series	Mounting	Action	Rod end configuration	Standard variations			Bore size (mm)	Standard stroke (mm)						
				Built-in magnet	With lock mechanism	With cancel		Built-in One-touch fittings	10	15	20	25	30	
RSQ	Through-hole	Double acting	Round bar type	•	•	•	•	•	•	•	•	•	•	•
			Round bar with female rod end	•	•	•	•	•	•	•	•	•	•	•
			Chamfered type	•	•	•	•	•	•	•	•	•	•	•
	Both ends tapped type	Double acting with spring loaded	Chamfered with female rod end	•	•	•	•	•	•	•	•	•	•	•
			Roller type	•	•	•	•	•	•	•	•	•	•	•
			Lever type	Fixed	•	•	•	•	•	•	•	•	•	•
Adjustable	•	•	•	•	•	•	•	•	•	•	•			
RSG	Flange type	Double acting	Round bar type	•	•	•	•	•	•	•	•	•	•	•
			Roller type	•	•	•	•	•	•	•	•	•	•	•
			Chamfered type	•	•	•	•	•	•	•	•	•	•	•
		Double acting with spring loaded	Lever type	Fixed	•	•	•	•	•	•	•	•	•	•
			Adjustable	•	•	•	•	•	•	•	•	•	•	•
			Single acting	•	•	•	•	•	•	•	•	•	•	•
Spring extend	•	•	•	•	•	•	•	•	•	•	•			

ø12, ø16, ø20, ø32, ø40, ø50

Additional variations now include the option to have a female rod end on the “**round bar type**” and the “**chamfered type**”.

8 types → **10 types**

(Excluding ø12)

The new body allows for auto switch mounting on 4 faces.

(Excluding ø12)

Mounting brackets are not required. Compact auto switches are mountable.

Solid state auto switch
D-M9□

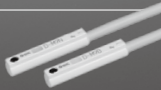

Reed auto switch
D-A9□





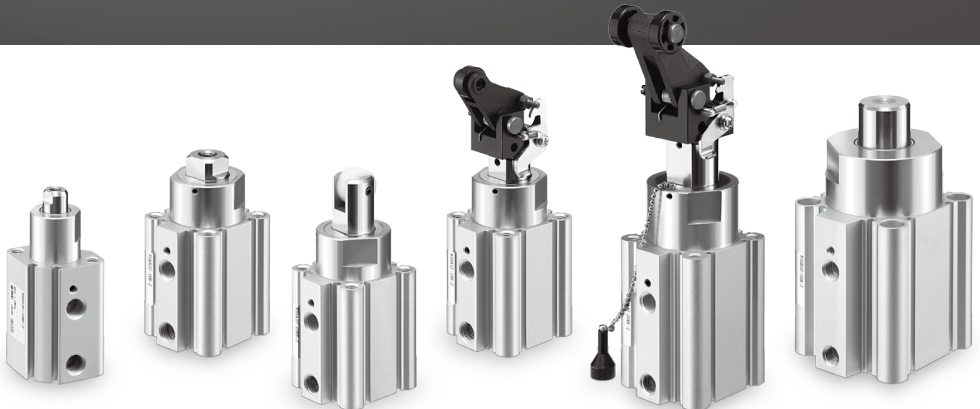



Magnetic field-resistant auto switch
D-P3DWA



Various rod end configurations

Shape can be selected to suit the intended application.

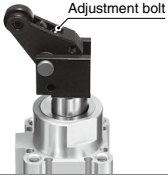
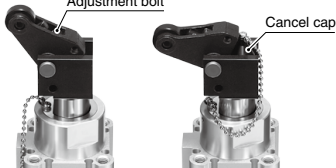
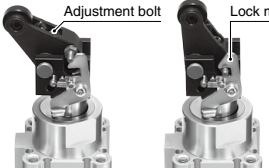
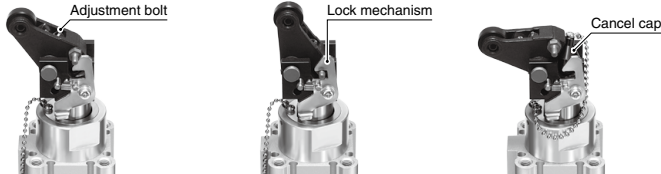
<p>Nil Round Bar</p> 	<p>F Round Bar with Female Rod End (Excluding $\phi 12$)</p> 	<p>K Chamfered</p> 	<p>G Chamfered with Female Rod End (Excluding $\phi 12$)</p> 	<p>R Roller</p> 
<p>L Lever (Fixed Absorber Type)</p> 		<p>B Lever (Adjustable Absorber Type)</p> 		
<p>C Lever (Adjustable Absorber Type) with Cancel Cap</p> 		<p>D Lever (Adjustable Absorber Type) with Lock Mechanism</p> 		
<p>E Lever (Adjustable Absorber Type) with Lock Mechanism and Cancel Cap</p> 				

* Only sizes $\phi 32$, $\phi 40$, and $\phi 50$ are applicable to the lever type.

Easy replacement of shock absorbers

- The shock absorber incorporated in the lever type is adjustment-free and easy-to maintain. ($\phi 32$, $\phi 40$, $\phi 50$)
- Replaceable just by loosening the set screw

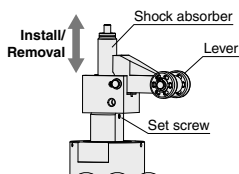

Three types of mounting

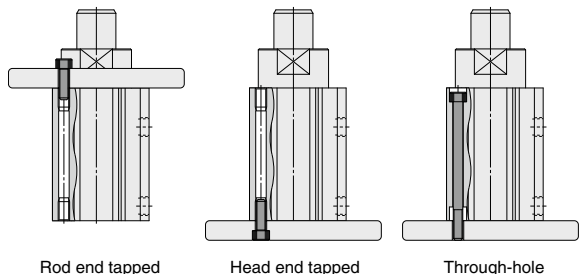







Rod end tapped

Head end tapped

Through-hole

CONTENTS

Stopper Cylinder *RSQ Series*

■ Model Selection	p. 605	
■ How to Order	p. 606	
■ Specifications	p. 607	
■ Weight	p. 608	
■ Construction	p. 610	
■ Dimensions		
	Rod End Configuration Round Bar	p. 612
	Rod End Configuration Chamfered (Non-rotating Piston Rod)	p. 613
	Rod End Configuration Roller	p. 614
	Rod End Configuration Lever (Fixed Absorber Type)	p. 615
	Rod End Configuration Lever (Adjustable Absorber Type)	p. 616
	Rod End Configuration Lever (Adjustable Absorber Type) with Lock Mechanism	p. 617
■ Auto Switch Mounting	p. 618	
■ Specific Product Precautions	p. 634	

RSQ Series Model Selection

Operating Range

Example 1 Transfer speed: 15 m/min
Weight of transferred object: 30 kg
Rod end configuration: Roller

<Selection method>

Find the intersection of the transfer speed of 15 m/min on the horizontal axis and the weight of the transferred object of 30 kg on the vertical axis in graph [1], and select the **RSQ□40-□□RZ** that falls in the cylinder operating range.

Graph 1
Round Bar/Chamfered/Roller

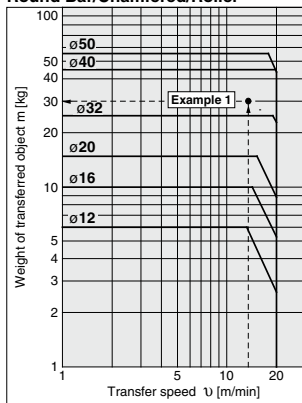

Example 2 Transfer speed: 15 m/min
Weight of transferred object: 60 kg
Friction coefficient $\mu = 0.1$
Rod end configuration: Lever

<Selection method>

Find the intersection of the transfer speed of 15 m/min on the horizontal axis and the weight of the transferred object of 60 kg on the vertical axis in graph [2], and select the **RSQ□40-□□LZ** that falls in the cylinder operating range.

Graph 2
Lever

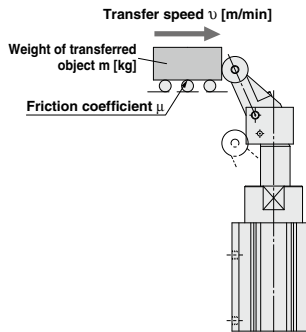
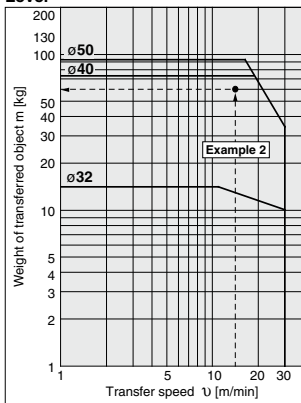

- * Graph [2] shows the case of a Lever Type with a friction coefficient $\mu = 0.1$ and at room temperature (20 to 25°C).
- * When selecting cylinders, confirm the Specific Product Precautions as well.

Lateral Load and Operating Pressure

The larger the lateral load, the higher the operating pressure required for the stopper cylinder. Set the operating pressure using the graphs shown on the right as a guide. (Applicable to round bar, chamfered, roller type rod end configurations.)

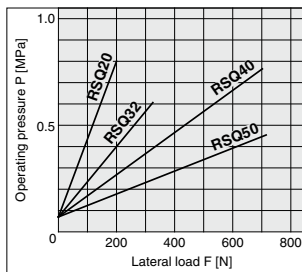
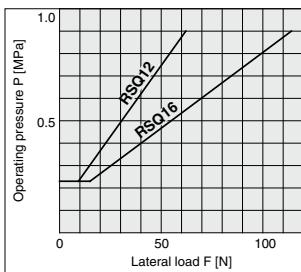

Stopper Cylinder Fixed Mounting Height

RSQ Series

ø12, ø16, ø20, ø32, ø40, ø50

RoHS

How to Order

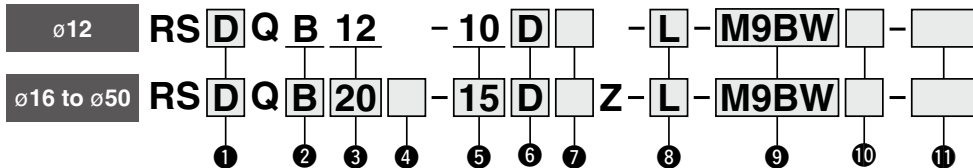

1 With auto switch

Nil	Without magnet for switch*1
D	With auto switch (Built-in magnet)

*1 In the case of without magnet for switch, auto switch cannot be mounted.

2 Mounting

B	Through-hole
A	Both ends tapped

* Since ø12 uses a common tube for both A and B, only B is used for part no. denotation.

3 Bore size

12	12 mm
16	16 mm
20	20 mm
32	32 mm
40	40 mm
50	50 mm

4 Port thread type

Nil	M thread	ø12, ø16
	Rc	
TN	NPT	ø20 to ø50
TF	G	
F	Built-in One-touch fittings*2	

*2 Bore sizes available w/ One-touch fittings are ø20 to ø50.
* TF for ø20 indicates M5.

5 Cylinder stroke

	[mm]
12	10
16	10, 15
20	10, 15, 20
32	10, 15, 20
40	20, 25, 30
50	20, 25, 30

6 Action

D	Double acting
B	Double acting with spring loaded
T	Single acting / spring extend

7 Rod end configuration

Nil	Round bar
F	Round bar with female rod end*3
K	Chamfered
G	Chamfered with female rod end*3
R	Roller
L	Lever (Fixed absorber type)
B	Lever (Adjustable absorber type)
C	Lever (Adjustable absorber type) with cancel cap
D	Lever (Adjustable absorber type) with lock mechanism
E	Lever (Adjustable absorber type) with lock mechanism and cancel cap

* The lever type rod end is applicable only to bore sizes ø32, ø40, and ø50.
*3 Excluding ø12

8 Mounting bolt

Nil	None
L	Shipped together

* Mounting bolt is shipped together only when the "Mounting" symbol is B. For details about the mounting bolt sizes, refer to page 608.

9 Auto switch

Nil	Without auto switch
------------	---------------------

* For applicable auto switches, refer to the table below.

10 Number of auto switches

Nil	2
S	1

11 Made to order

For details, refer to page 607.

Applicable Auto Switches/Refer to pages 1341 to 1435 for further information on auto switches.

Type	Special function	Electrical entry	Indicator light	Wiring (Output)	Load voltage		Auto switch model		Lead wire length [m]					Pre-wired connector	Applicable load		
					DC	AC	Perpendicular	In-line	0.5 (Nil)	1 (M)	3 (L)	5 (Z)	None (N)				
Solid state auto switch	—	Grommet	Yes	3-wire (NPN)	24 V	5 V, 12 V	—	M9NV	M9N	●	●	●	○	—	○	IC circuit	
				3-wire (PNP)				M9PV	M9P	●	●	●	○	—	○		
				2-wire				M9BV	M9B	●	●	●	○	—	○		
				2-wire				M9BV	M9B	●	●	●	○	—	○		
	Diagnostic indication (2-color indicator)			3-wire (NPN)				M9NVW	M9NW	●	●	●	○	—	○		IC circuit
				3-wire (PNP)				M9PVW	M9PW	●	●	●	○	—	○		
				2-wire				M9BWW	M9BW	●	●	●	○	—	○		
				2-wire				M9BWW	M9BW	●	●	●	○	—	○		
Water-resistant (2-color indicator)	3-wire (NPN)	M9NAV ⁻¹	M9NA ⁻¹	○	○	○	○	—	○	IC circuit							
	3-wire (PNP)	M9PAV ⁻¹	M9PA ⁻¹	○	○	○	○	—	○								
	2-wire	M9BAV ⁻¹	M9BA ⁻¹	○	○	○	○	—	○								
	2-wire	M9BAV ⁻¹	M9BA ⁻¹	○	○	○	○	—	○								
Reed auto switch	—	Grommet	Yes	2-wire (Non-polar)	24 V	5 V, 12 V	100 V or less	—	P3DWA	●	—	●	—	○	—		
				3-wire (NPN equivalent)				A96V	A96	●	—	●	—	○			
				2-wire				A93V ⁻²	A93	●	●	●	—	—		—	
—	—	No	2-wire	24 V	5 V, 12 V	100 V or less	A90V	A90	●	—	●	—	—	—	IC circuit		
							—	—	—	—	—	—	—	—	—	—	—

*1 Water-resistant type auto switches can be mounted on the above models, but SMC cannot guarantee water resistance.

Please contact SMC regarding water-resistant types with the above model numbers.

*2 The 1 m lead wire is only applicable to the D-A93.

* Lead wire length symbols: 0.5 m..... Nil (Example) M9NW
1 m..... M (Example) M9NWM
3 m..... L (Example) M9NWL
5 m..... Z (Example) M9NWX

* Solid state auto switches marked with "○" are produced upon receipt of order.
* The D-P3DWA□ is mountable on bore size ø32 to ø50.

* Since there are applicable auto switches other than those listed above, refer to page 621 for details.



Symbol

Rubber bumper

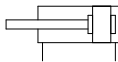

Made to Order
Common Specifications
[Click here for details](#)

Symbol	Specifications
-XA□	Change of rod end shape
-XB11	Long stroke type*1
-XC3	Special port location

*1 Double acting, Round bar type only.

For details on the water-resistant cylinder and the series compatible with secondary batteries (25A-), refer to the **Web Catalog**.

For details of cylinders with auto switches ⇨ pages 618 to 621

- Auto Switch Proper Mounting Position (Detection at stroke end) and Mounting Height
- Operating Range
- Auto Switch Mounting Brackets/Part Nos.

Specifications

Bore size [mm]	12	16	20	32	40	50
Action	Double acting, Double acting with spring loaded, Single acting / spring extend					
Fluid	Air					
Proof pressure	1.5 MPa					
Maximum operating pressure	1.0 MPa					
Ambient and fluid temperatures	Without auto switch: -10°C to 70°C With auto switch: -10°C to 60°C (No freezing)					
Lubricant	Not required (Non-lube)					
Cushion	Rubber bumper					
Stroke length tolerance	$+1.4+1$ 0					
Piston speed	50 to 500 mm/s					
Mounting	Through-hole, Both ends tapped					

*1 Stroke length tolerance does not include the amount of bumper change.

Standard Strokes

Bore size	Rod end configuration [mm]	
	Round bar, Chamfered, Roller	Lever
12	10	—
16	10, 15	—
20	10, 15, 20	—
32		10, 15, 20
40	20, 25, 30	20, 25, 30
50		20, 25, 30

Spring Force (Single acting / spring extend)

Bore size [mm]	Extended [N]	Compressed [N]
12	3.9	9.6
16	4.9	14.9
20	3.4	14.9
32	8.8	18.6
40, 50	13.7	27.5

* Applicable only to round bar, chamfered, and roller type rod end configurations.

RSQ Series

Type

Bore size [mm]		12	16	20	32	40	50
Mounting	Through-hole	●*1	●	●	●	●	●
	Both ends tapped	●	●	●	●	●	●
Built-in magnet			●	●	●	●	●
Piping	Screw-in	M5 x 0.8			1/8*2		
	Built-in One-touch fittings	—			ø6/4		ø8/6
Action		Double acting, Double acting with spring loaded, Single acting / spring extend					
Rod end configuration	Round bar				●		
	Chamfered				●		
	Roller				●		
	Lever	—				●	

*1 ø12 tubes can have both through-hole and tap mountings in the same tube.

*2 TF (G thread) for ø20 indicates M5 x 0.8.

Weight

Action	Bore size [mm]	Rod end configuration	Cylinder stroke [mm]					[kg]
			10	15	20	25	30	
Double acting	12	Round bar, Chamfered, Roller	0.07	—	—	—	—	
	16	Round bar, Chamfered, Roller	0.13	0.14	—	—	—	
	20	Round bar, Chamfered, Roller	0.22	0.23	0.24	—	—	
Double acting with spring loaded	32	Round bar, Chamfered, Roller	0.41	0.43	0.45	—	—	
		Lever	0.50	0.52	0.54	—	—	
Single acting / spring extend	40	Round bar, Chamfered, Roller	—	—	0.73	0.79	0.85	
		Lever	—	—	0.96	1.00	1.04	
	50	Round bar, Chamfered, Roller	—	—	0.98	1.02	1.06	
		Lever	—	—	1.21	1.25	1.29	

Mounting Bolt for RSQB

Mounting bolts for the RSQB are available. Refer to the following mounting bolt part numbers.

Order the actual number of bolts that will be used.

Example) CQ-M3X55L 2 pcs.

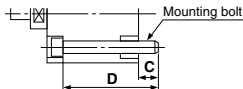

Cylinder model	C	D	Mounting bolt part no.
*1RSQB12-10□	5	45	CQ-M3X45L
RSQB16-10□	7.5	55	CQ-M3X55L
-15□		60	X60L
RSQB20-10□	7	55	CQ-M5X55L
-15□		60	X60L
-20□		65	X65L
RSQB32-10□	9	60	CQ-M5X60L
-15□		65	X65L
-20□		70	X70L
RSQB40-20□	9.5	75	CQ-M5X75L
-25□		80	CQ-M5X80L
-30□		85	X85L
RSQB50-20□	9	75	CQ-M6X75L
-25□		80	X80L
-30□		85	X85L

*1 Be sure to use the attached flat washers when mounting ø12 cylinders with through-holes.

RSQ Series

Construction

Double acting (D)

Rod end configuration: Roller (R)

ø12

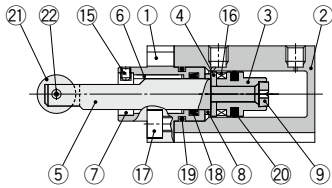

ø16

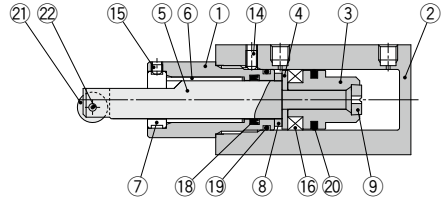

ø20

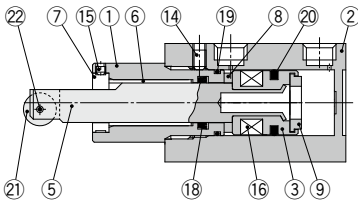

ø32, ø40, ø50

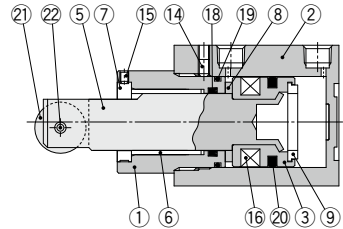

Double acting with spring loaded (B)

ø12, ø16

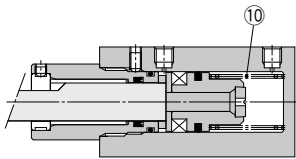

ø20, ø32, ø40, ø50

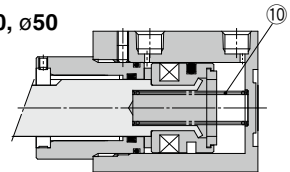

Single acting / spring extend (T)

ø12, ø16

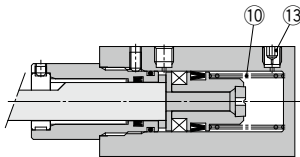

ø20, ø32, ø40, ø50

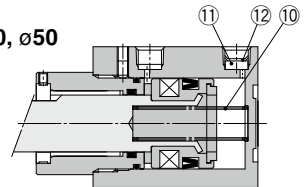

Component Parts

No.	Description	Material	Note
1	Rod cover	Aluminum alloy	Anodized
2	Cylinder tube	Aluminum alloy	Hard anodized
3	Piston	Aluminum alloy	
4	Spacer for switch	Aluminum alloy	ø12, ø16 only
5	Piston rod	ø12, ø16, ø20: Stainless steel ø32, ø40, ø50: Carbon steel	Hard chrome plating
6	Bushing	Bearing alloy	
7	Non-rotating guide	Rolled steel	Non-rotating type only Excluding the round bar type rod end
8	Bumper A	Urethane	
9	Bumper B	Urethane	
10	Return spring	Steel wire	Zinc chromated (Excluding double acting)
11	Element	Sintered metallic BC	ø20 to ø50 only (Single acting only)

No.	Description	Material	Note
12	Retaining ring	Carbon tool steel	ø20 to ø50 only (Single acting only)
13	Plug with fixed orifice	Alloy steel	ø12, ø16 only (Single acting only)
14	Hexagon socket head set screw	Chromium molybdenum steel	Excluding ø12
15	Hexagon socket head set screw	Chromium molybdenum steel	Non-rotating type only Excluding the round bar type rod end
16	Magnet	—	
17	Hexagon socket head cap screw	Alloy steel	ø12 only
18	Rod seal	NBR	
19	Gasket	NBR	
20	Piston seal	NBR	
21	Roller A	Resin	
22	Spring pin	Carbon tool steel	

Construction

Rod end configuration:

Round bar (NII)

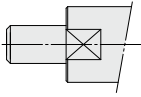

Round bar with female thread (F)

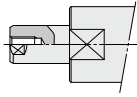

Chamfered (K)

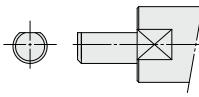

Chamfered with female thread (G)

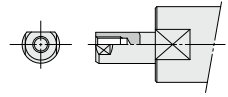

Lever (Fixed absorber type)

(ø32, ø40, ø50 only)

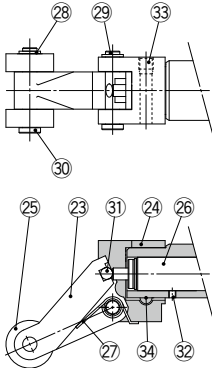

Lever (Adjustable absorber type)

(ø32, ø40, ø50 only)

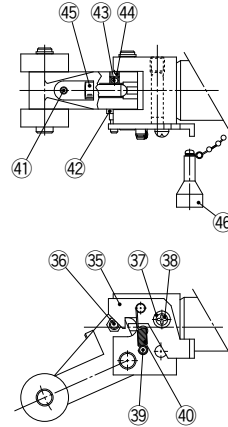

Only one roller is provided for ø32.

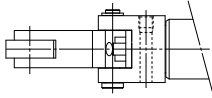

Component Parts

No.	Description	Material	Note
23	Lever	Cast iron	
24	Lever holder	Rolled steel	
25	Roller B	Resin	
26	Shock absorber	—	
27	Lever spring	Stainless steel wire	
28	C retaining ring for axis	Carbon tool steel	
29	Lever pin	Carbon steel	
30	Roller pin	Carbon steel	
31	Steel ball	High carbon chrome bearing steel	
32	Hexagon socket head set screw	Chromium molybdenum steel	
33	Hexagon socket head set screw	Chromium molybdenum steel	
34	One-side tapered pin	Carbon steel	

No.	Description	Material	Note
35	Bracket	Carbon steel	
36	Pin B	Carbon steel	
37	Spacer	Carbon steel	
38	Cross recessed round head screw	Rolled steel	
39	Pin A	Rolled steel	
40	Bracket spring	Steel wire	
41	Hexagon socket head set screw	Chromium molybdenum steel	
42	Spring washer	Steel wire	
43	Urethane ball	Urethane	
44	Hexagon socket head set screw	Chromium molybdenum steel	
45	Adjustment bolt	Bearing steel	
46	Cancel cap	Aluminum alloy	

Replacement Parts: Seal Kit

Bore size [mm]	Kit no.			Contents
	Double acting	Double acting with spring loaded	Single acting / spring extend	
12	RSQ12D-PS		RSQ12T-PS	Set of nos. 18, 19, 20 on page 610
16	RSQ16D-PS	RSQ16B-PS	RSQ16T-PS	
20	RSQ20D-PS	RSQ20B-PS	RSQ20T-PS	
32	RSQ32D-PS	RSQ32B-PS	RSQ32T-PS	
40	RSQ40D-PS	RSQ40B-PS	RSQ40T-PS	
50	RSQ50D-PS	RSQ50B-PS	RSQ50T-PS	

Replacement Parts: Shock Absorber

Bore size [mm]	Kit no.
32	RB1007-X225
40, 50	RB1407-X552

* The seal kit includes 18, 19, and 20. Order the seal kit based on each bore size.

* The seal kit does not include a grease pack. Order it separately.

Grease pack part number: GR-S-010 (10 g)

RSQ Series

These six figures show the piston rod extended.

The dimensions of the double acting type with spring loaded, and single acting/spring extend type are the same as those of the double acting type.

Dimensions

Rod end configuration: Round bar, Mounting: Through-hole

Bore size: $\phi 12$ RS□QB12-10D (Double acting)

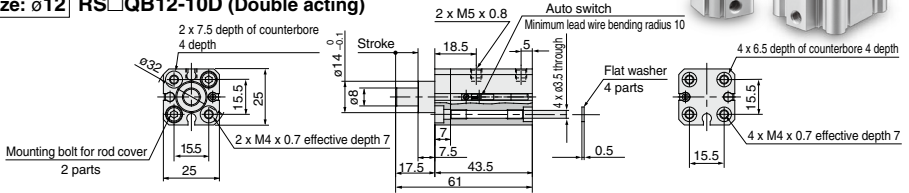

Bore size: $\phi 16$, $\phi 20$ RS□QB¹⁶/₂₀-□DZ (Double acting)

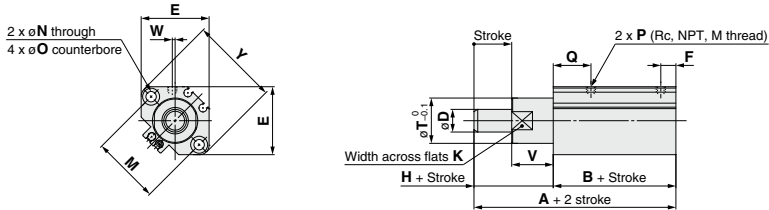

Bore size: $\phi 32$, $\phi 40$, $\phi 50$ RS□QB³²/₄₀/₅₀-□DZ (Double acting)

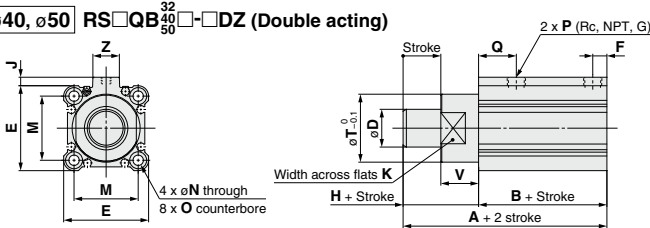

Mounting: Both ends tapped

RS□QA

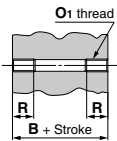

Bore size	B	O1	R
16	41.5	M4 x 0.7	7
20	45	M6 x 1	10
32	48	M6 x 1	10
40	52.5	M6 x 1	10
50	54	M8 x 1.25	14

* Dimensions other than those shown above are the same as the drawings above.

Female rod end

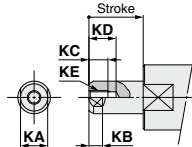

Bore size	KA	KB	KC	KD	KE
16	8	4.5	8	10.5	M4 x 0.7
20	10	5	7	10	M5 x 0.8
32	17	7.5	13	16.5	M8 x 1.25
40	22	9.5	13	16.5	M8 x 1.25
50	22	9.5	13	16.5	M8 x 1.25

Built-in One-touch fittings ($\phi 20$ to $\phi 50$)

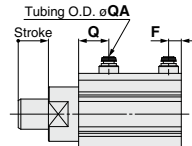
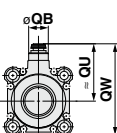
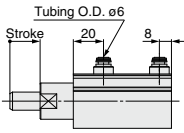
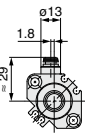

Bore size	QA	F	Q	QB	QU	QW
32	6	7.5	20	13	38	60.5
40	6	8	24.5	13	42	68
50	8	9.5	26	16	50	82

Bore size	A	B	D	E	F	H	J	K	M	N	O	P			Q	T	V	Y	Z	W		
												Rc	NPT	G						Rc	NPT	G
16	59.5	41.5	10	29	6	18	—	18	28	3.5	6.5 depth 4	M5 x 0.8	M5 x 0.8	M5 x 0.8	17	20	18	37	—	0	0	0
20	67	45	12	36	8	22	—	22	36	5.5	9 depth 7	1/8	1/8	M5 x 0.8	20	24	22	47	—	1.5	1.5	0
32	68	48	20	45	7.5	20	4.5	32	34	5.5	9 depth 7	1/8	1/8	1/8	20	36	20	—	14	—	—	—
40	80.5	52.5	25	52	8	28	5	41	40	5.5	9 depth 7	1/8	1/8	1/8	24.5	44	28	—	15	—	—	—
50	82	54	25	64	8	28	7	50	50	6.6	11 depth 8	1/8	1/8	1/8	24.5	56	28	—	19	—	—	—

* Refer to pages 618 and 619 for the auto switch proper mounting position and mounting height.

* For the single acting type, a One-touch fitting is on the rod end only. * The position of the width across flats (K) is arbitrary and is not specified.

Stopper Cylinder **RSQ Series**

These 4 figures show the piston rod extended.
The dimensions of the double acting type with spring loaded, and single acting/
spring extend type are the same as those of the double acting type.



Dimensions

Rod end configuration: Chamfered (Non-rotating piston rod)

Mounting: Through-hole

Bore size: $\phi 12$ RS□QB12-10DK (Double acting)

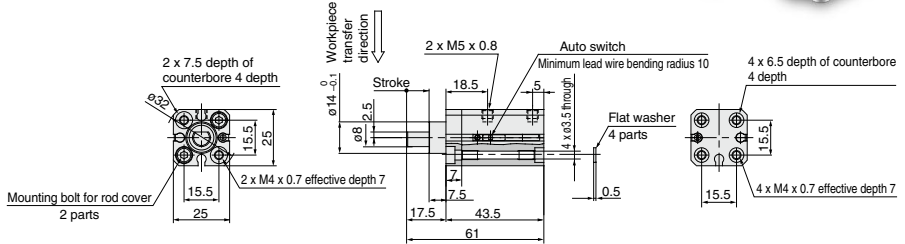

Bore size: $\phi 16$, $\phi 20$ RS□QB₂₀□-□DKZ (Double acting)

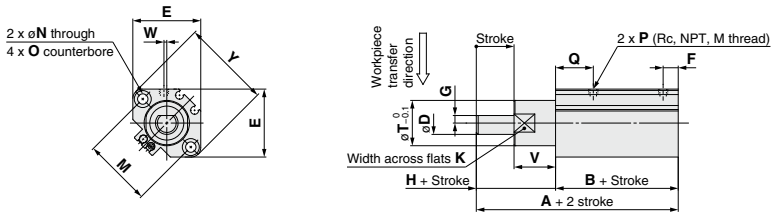

Bore size: $\phi 32$, $\phi 40$, $\phi 50$ RS□QB_{32/40/50}□-□DKZ (Double acting)

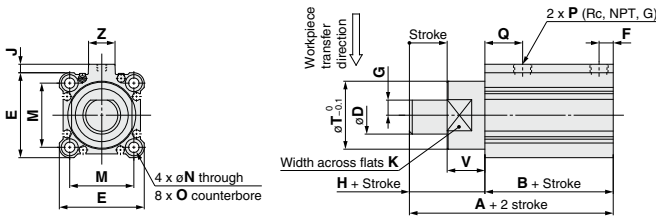

Mounting: Both ends tapped

RS□QA

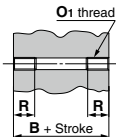

Bore size	B	O ₁	[mm]
16	41.5	M4 x 0.7	7
20	45	M6 x 1	10
32	48	M6 x 1	10
40	52.5	M6 x 1	10
50	54	M8 x 1.25	14

* Dimensions other than those shown above are the same as the drawings above.

Female rod end

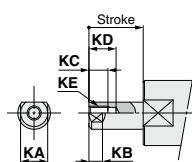

Bore size	KA	KB	KC	KD	KE	[mm]
16	8	4.5	8	10.5	M4 x 0.7	
20	10	5	7	10	M5 x 0.8	
32	17	7.5	13	16.5	M8 x 1.25	
40	22	9.5	13	16.5	M8 x 1.25	
50	22	9.5	13	16.5	M8 x 1.25	

Refer to page 612 for dimensions of the model with built-in One-touch fittings.

Bore size	A	B	D	E	F	G	H	J	K	M	N	O	P			Q	T	V	Y	Z	W		
													Rc	NPT	G						Rc	NPT	G
16	59.5	41.5	10	29	6	3	18	—	18	28	3.5	6.5 depth 4	M5 x 0.8	M5 x 0.8	M5 x 0.8	17	20	18	37	—	0	0	0
20	67	45	12	36	8	4	22	—	22	36	5.5	9 depth 7	1/8	1/8	M5 x 0.8	20	24	22	47	—	1.5	1.5	0
32	68	48	20	45	7.5	8	20	4.5	32	34	5.5	9 depth 7	1/8	1/8	1/8	20	36	20	—	—	—	—	—
40	80.5	52.5	25	52	8	10	28	5	41	40	5.5	9 depth 7	1/8	1/8	1/8	24.5	44	28	—	—	—	—	—
50	82	54	25	64	8	10	28	7	50	50	6.6	11 depth 8	1/8	1/8	1/8	24.5	56	28	—	—	—	—	—

* Refer to pages 618 and 619 for the auto switch proper mounting position and mounting height.

* For the single acting type, a One-touch fitting is on the rod end only. * The position of the width across flats (K) is arbitrary and is not specified.

RSQ Series

These 3 figures show the piston rod extended.
The dimensions of the double acting type with spring loaded, and single acting/
spring extend type are the same as those of the double acting type.



Dimensions

Rod end configuration: Roller type, Mounting: Through-hole

Bore size: $\phi 12$ RS□QB12-10DR (Double acting)

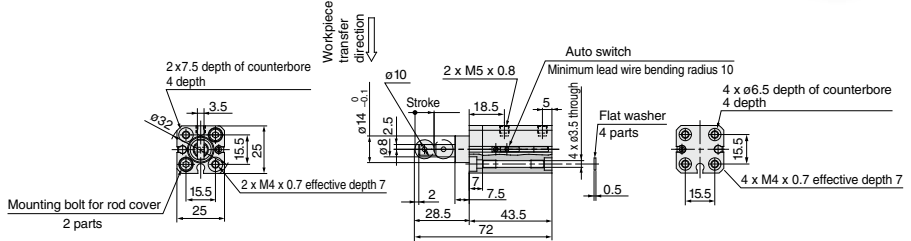

Bore size: $\phi 16, \phi 20$ RS□QB¹⁶/₂₀□-□DRZ (Double acting)

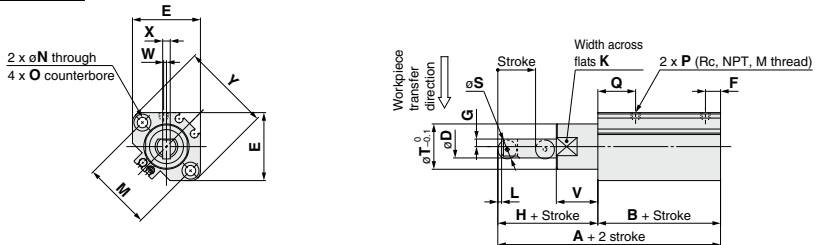

Bore size: $\phi 32, \phi 40, \phi 50$ RS□QB³²/₄₀/₅₀□-□DRZ (Double acting)

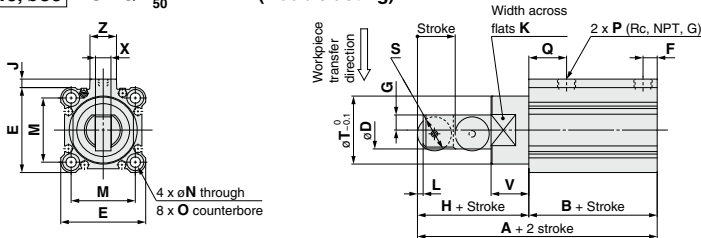

Mounting: Both ends tapped

RS□QA

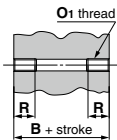

Bore size	B	O ₁	R
16	41.5	M4 x 0.7	7
20	45	M6 x 1	10
32	48	M6 x 1	10
40	52.5	M6 x 1	10
50	54	M8 x 1.25	14

* Dimensions other than those shown above are the same as the drawings above.

Refer to page 612 for dimensions of the model with built-in One-touch fittings.

Bore size	A	B	D	E	F	G	H	J	K	L	M	N	O	P			Q	S	T	V	X	Y	Z	W		
														Rc	NPT	G								Rc	NPT	G
														16	68	41.5								10	29	6
20	78	45	12	36	8	4	33	—	22	2	36	5.5	9 depth 7	1/8	1/8	M5 x 0.8	20	10	24	22	4	47	—	1.5	1.5	0
32	87	48	20	45	7.5	8	39	4.5	32	3	34	5.5	9 depth 7	1/8	1/8	1/8	20	18	36	20	8	—	14	—	—	—
40	105.5	52.5	25	52	8	10	53	5	41	4	40	5.5	9 depth 7	1/8	1/8	1/8	24.5	24	44	28	9	—	19	—	—	—
50	107	54	25	64	8	10	53	7	50	4	50	6.6	11 depth 8	1/8	1/8	1/8	24.5	24	56	28	9	—	19	—	—	—

* Refer to pages 618 and 619 for the auto switch proper mounting position and mounting height.

* For the single acting type, a One-touch fitting is on the rod end only.

* The position of the width across flats (K) is arbitrary and is not specified.

Stopper Cylinder **RSQ Series**

These 2 figures show the piston rod extended.
 The dimensions of the double acting type with spring loaded, and single acting/spring extend type are the same as those of the double acting type.



Dimensions

Rod end configuration: Lever (Fixed extensor type), Mounting: Through-hole

Bore size: $\phi 32$ RS□QB32□-□DLZ (Double acting)

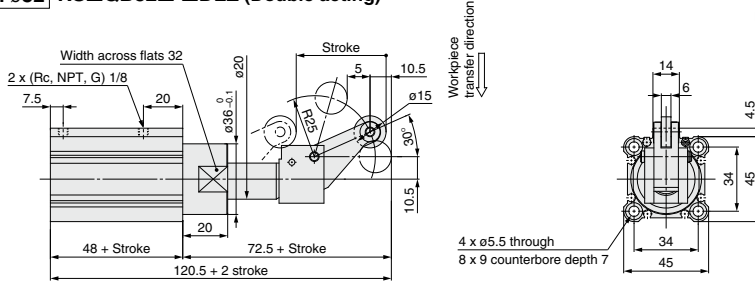

Bore size: $\phi 40, \phi 50$ RS□QB $\begin{smallmatrix} 40 \\ 50 \end{smallmatrix}$ □-□DLZ (Double acting)

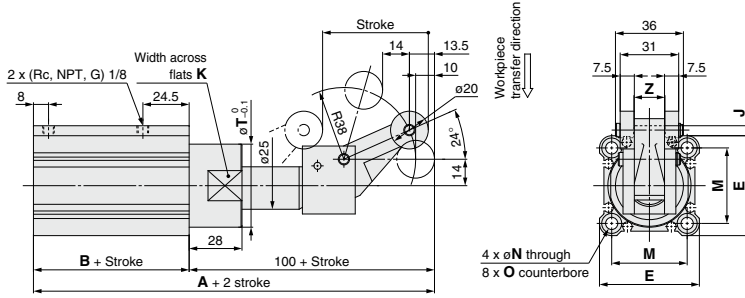

Mounting: Both ends tapped

RS□QA

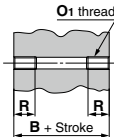

Bore size	B	O ₁	R	[mm]
32	48	M6 x 1	10	
40	52.5	M6 x 1	10	
50	54	M8 x 1.25	14	

* Dimensions other than those shown above are the same as the drawings above.

Refer to page 612 for dimensions of the model with built-in One-touch fittings.

Bore size	A	B	E	J	K	M	N	O	T	Z	[mm]
40	152.5	52.5	52	5	41	40	5.5	9 depth 7	44	15	
50	154	54	64	7	50	50	6.6	11 depth 8	56	19	

- * Refer to pages 618 and 619 for the auto switch proper mounting position and mounting height.
- * For the single acting type, a One-touch fitting is on the rod end only.
- * The position of the width across flats (K) is arbitrary and is not specified.

RSQ Series

These 3 figures show the piston rod extended.
The dimensions of the double acting type with spring loaded, and single acting/
spring extend type are the same as those of the double acting type.

Dimensions

Rod end configuration: Lever (Adjustable absorber type)
Mounting: Through-hole

Bore size: $\phi 32$ RS□QB32□□DBZ (Double acting)

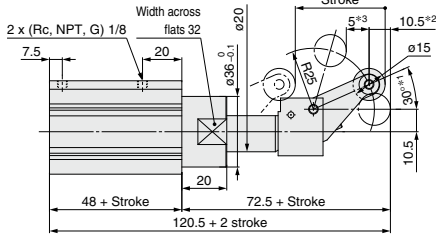

Workpiece transfer direction

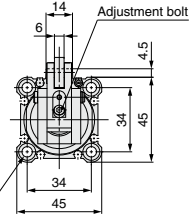

Bore size: $\phi 40, \phi 50$ RS□QB $\frac{40}{50}$ □□DBZ (Double acting)

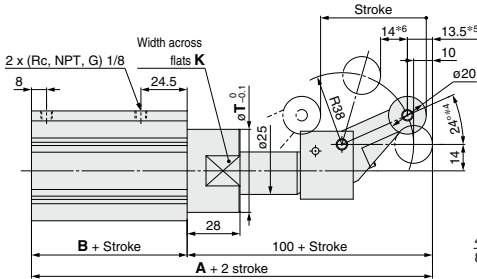

Workpiece transfer direction

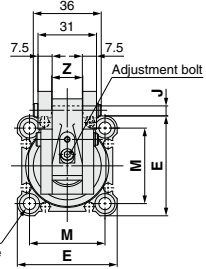

With cancel cap RS□QB□□□DCZ (Double acting)

* Dimensions are the same as the drawings above.

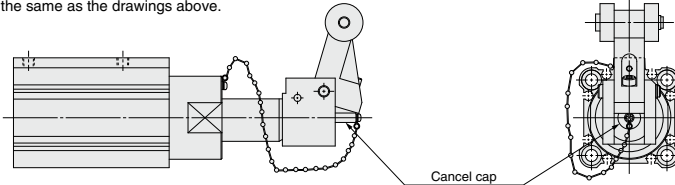

Mounting: Both ends tapped

RS□QA

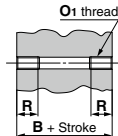

Bore size	B	O1	R
32	48	M6 x 1	10
40	52.5	M6 x 1	10
50	54	M8 x 1.25	14

* Dimensions other than those shown above are the same as the drawings above.

Bore size	A	B	E	J	K	M	N	O	T	Z
40	152.5	52.5	52	5	41	40	5.5	9 depth 7	44	15
50	154	54	64	7	50	50	6.6	11 depth 8	56	19

* Refer to pages 618 and 619 for the auto switch proper mounting position and mounting height.

* For the single acting type, a One-touch fitting is on the rod end only.

* The figures show the dimensions when the adjustment bolt is lowered (when energy absorption is at its maximum). However, these dimensions with asterisk change within the ranges shown below as the adjustment bolt is raised (energy absorption is reduced).

$\phi 32 \dots 30^{*0.1} \rightarrow 20^\circ, 10.5^{*2} \rightarrow 9, 5^{*3} \rightarrow 6$

$\phi 40, 50 \dots 24^{*0.4} \rightarrow 16^\circ, 13.5^{*5} \rightarrow 11.5, 14^{*6} \rightarrow 16$

* The position of the width across flats (K) is arbitrary and is not specified.

Refer to page 612 for dimensions of the model with built-in One-touch fittings.

These 3 figures show the piston rod extended.
The dimensions of the double acting type with spring loaded, and single acting/
spring extend type are the same as those of the double acting type.



Dimensions

Rod end configuration: Lever (Adjustable absorber type), With lock mechanism
Mounting: Through-hole

Bore size: $\phi 32$ RS□QB32□□DDZ (Double acting)

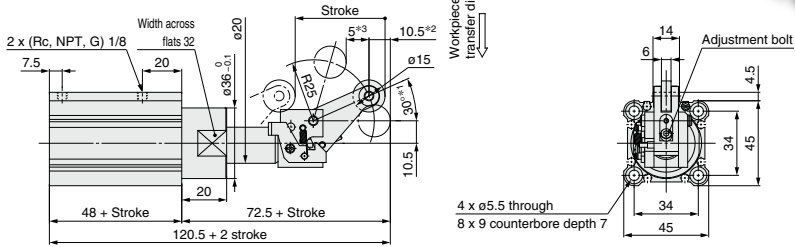

Bore size: $\phi 40, \phi 50$ RS□QB₅₀□□DDZ (Double acting)

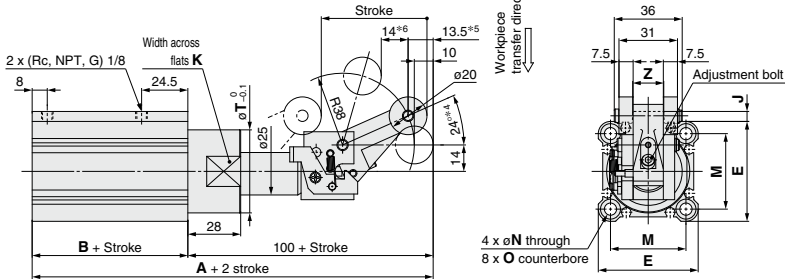

With lock mechanism + cancel cap RS□QB□□□DEZ (Double acting)

* Dimensions are the same as the drawings above.

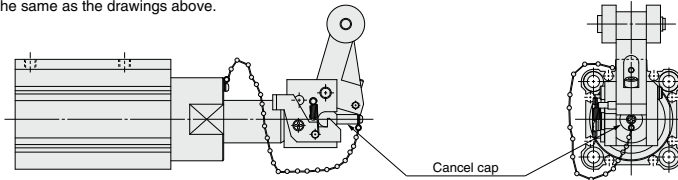

Mounting: Both ends tapped

RS□QA

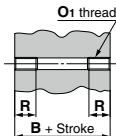

Bore size	B	O ₁	R
32	48	M6 x 1	10
40	52.5	M6 x 1	10
50	54	M8 x 1.25	14

* Dimensions other than those shown above are the same as the drawings above.

Bore size	A	B	E	J	K	M	N	O	T	Z
40	152.5	52.5	52	5	41	40	5.5	9 depth 7	44	15
50	154	54	64	7	50	50	6.6	11 depth 8	56	19

Refer to page 612 for dimensions of the model with built-in One-touch fittings.

* Refer to pages 618 and 619 for the auto switch proper mounting position and mounting height.

* For the single acting type, a One-touch fitting is on the rod end only.

* The figures show the dimensions when the adjustment bolt is lowered (when energy absorption is at its maximum). However, these dimensions with asterisk change within the ranges shown below as the adjustment bolt is raised (energy absorption is reduced).

$\phi 32 \dots 30^{*0.1} \rightarrow 20^\circ, 10.5^{*2} \rightarrow 9, 5^{*3} \rightarrow 6$

$\phi 40, 50 \dots 24^{*0.4} \rightarrow 16^\circ, 13.5^{*5} \rightarrow 11.5, 14^{*6} \rightarrow 16$

* The position of the width across flats (K) is arbitrary and is not specified.

RSQ Series

Auto Switch Mounting

Auto Switch Proper Mounting Position (Detection at stroke end) and Mounting Height

D-M9□/M9□V
 D-M9□W/M9□WV
 D-M9□A/M9□AV
 D-A9□/A9□V

φ12

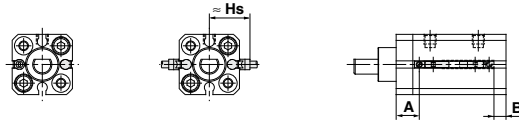

φ16, φ20

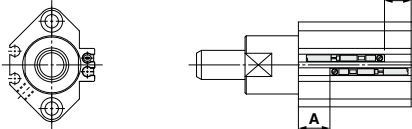

φ32 to φ50

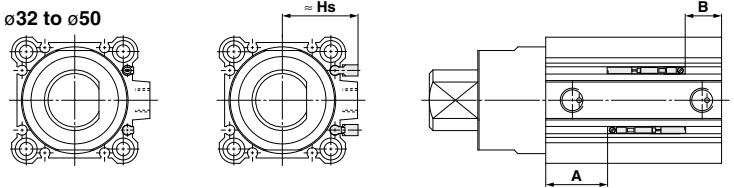

D-A7□
 D-A80
 D-A7□H
 D-A80H
 D-F7□
 D-J79
 D-F7□W
 D-J79W
 D-F79F
 D-F7NT
 D-F7BA
 D-A73C
 D-A80C
 D-J79C
 D-A79W
 D-F7□WV
 D-F7□V
 D-F7BAV

φ16, φ20

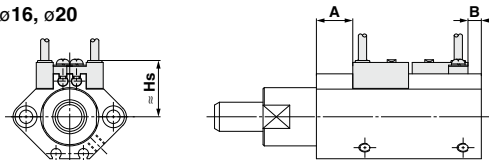

φ32 to φ50

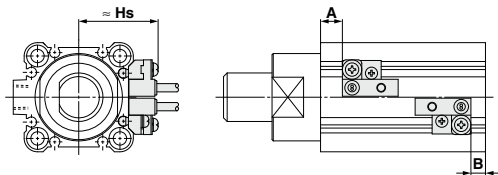

D-P3DWA

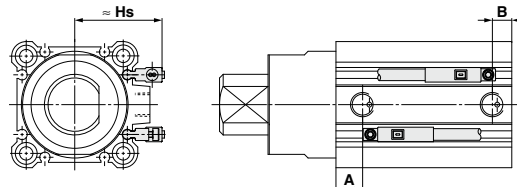

Auto Switch Proper Mounting Position (Detection at Stroke End) and Its Mounting Height

Auto Switch Proper Mounting Position

(mm)

Auto switch model	D-M9□ D-M9□V D-M9□W D-M9□WV D-M9□A D-M9□AV		D-A9□ D-A9□V		D-A73 D-A80		D-A72/A7□H/A80H D-A73C/A80C D-F7□/J79 D-F7□V/J79C D-F7BAV/F7BA D-F7□W/J79W D-F7□WV/F79F		D-F7NT		D-A79W		D-P3DWA	
	A	B	A	B	A	B	A	B	A	B	A	B	A	B
12	13	11	9	7	—	—	—	—	—	—	—	—	—	—
16	13	13	9	9	11.5	11.5	12	12	17	17	9	9	—	—
20	19	11	15	7	17.5	9.5	18	10	23	15	15	7	—	—
32	21	15	17	11	18	12	18.5	12.5	23.5	17.5	15.5	9.5	16.5	10.5
40	25.5	15	21.5	11	22.5	12	23	12.5	28	17.5	20	9.5	21	10.5
50	33.5	8.5	29.5	4.5	30.5	5.5	31	6	36	11	28	3	29	4

Note) Adjust the auto switch after confirming the operating conditions in the actual setting.

Auto Switch Mounting Height

(mm)

Auto switch model	D-M9□V D-M9□WV D-M9□AV		D-A9□V	D-A7□ D-A80	D-A7□H D-A80H/F7□ D-J79/F7□W D-F7BA D-J79W D-F79F D-F7NT	D-A73C D-A80C	D-F7□V D-F7□WV D-F7BAV	D-J79C	D-A79W	D-P3DWA
	Hs	Hs	Hs	Hs	Hs	Hs	Hs	Hs	Hs	Hs
12	19.5	17	—	—	—	—	—	—	—	—
16	22.5	20	22	22.5	28.5	24.5	27.5	25.5	—	—
20	25	23	24.5	25.5	31	27.5	30	28	—	—
32	30	27.5	34	36	40.5	36.5	39.5	37.5	35.5	—
40	32	30	37.5	38	43.5	40	42.5	40.5	38	—
50	37.5	35	43	43.5	49	45	48	46	43	—

Operating Range



(mm)

Auto switch model	Bore size (mm)					
	12	16	20	32	40	50
D-M9□/M9□V D-M9□W/M9□WV D-M9□A/M9□AV	3	5	5.5	6	6	7
D-A9□/A9□V	6	9.5	9	9.5	9.5	9.5
D-A7□/A80 D-A7H/A80H D-A73C/A80C	—	12	12	12	11	10
D-A79W	—	13	13	13	14	14
D-F7□/J79 D-F7□V/J79C D-F7□W/J7□WV D-F7BA/F7BAV D-F79F/F7NT	—	6	5.5	6	6	6
D-P3DWA	—	—	—	5.5	5	6

* Since this is a guideline including hysteresis, not meant to be guaranteed. (Assuming approximately ±30% dispersion) There may be the case to change substantially depending on an ambient environment.

* The values above for a bore size ø12 and over ø32 of D-A9□(V)/M9□(V)/M9□(V)/M9□(A)(V) types are measured when the current switch installation groove is attached without using the auto switch mounting bracket BQ2-012.

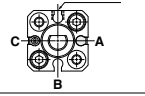
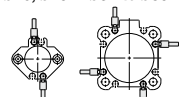
Auto Switch Mounting Brackets/Parts Nos.

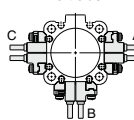
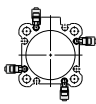
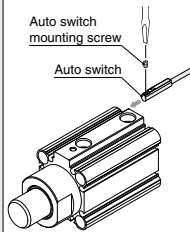
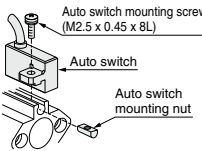
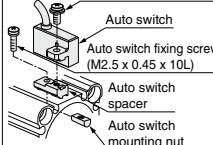
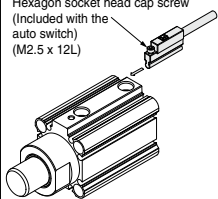
Applicable auto switch	D-M9□/M9□V D-M9□W/M9□WV D-M9□A/M9□AV D-A9□/A9□V	D-F7□/F7□V/J79/J79C/F7□W/J79W/F7□WV D-F7BA/F7BAV/F79F/F7NT D-A7□/A80/A7□H/A80H/A73C/A80C/A79W	D-P3DWA											
Bore size [mm]	ø12 to ø50	ø16, ø20	ø32 to ø50											
Auto switch mounting bracket part no.	—	BQ4-012	BQ5-032											
Auto switch mounting bracket fitting parts lineup/weight	—	<ul style="list-style-type: none"> Auto switch mounting screw (M2.5 x 8L) Auto switch mounting nut Weight: 1.5 g 	<ul style="list-style-type: none"> Auto switch fixing screw (M2.5 x 10L) Auto switch mounting screw (M3 x 8L) Auto switch spacer Auto switch mounting nut Weight: 3.5 g 											
Auto switch mounting surface	A/B/C side except port side (ø12) Surfaces with auto switch mounting slot ø12 Port side  ø16, ø20 ø32 to ø50 	Auto switch mounting rail side only 	A/B/C side except port side Port side 	Surfaces with auto switch mounting slot 										
Mounting of auto switch	 <ul style="list-style-type: none"> Auto switch mounting screw Auto switch <p>• When tightening the auto switch mounting screw, use a watchmakers screwdriver with a handle diameter of 5 to 6 mm.</p> <p>Tightening Torque of Auto Switch Mounting Screw [N·m]</p> <table border="1"> <thead> <tr> <th>Auto switch model</th> <th>Tightening torque</th> </tr> </thead> <tbody> <tr> <td>D-M9□(V)</td> <td rowspan="3">0.05 to 0.15</td> </tr> <tr> <td>D-M9□W(V)</td> </tr> <tr> <td>D-A93</td> </tr> <tr> <td>D-M9□A(V)</td> <td>0.05 to 0.10</td> </tr> <tr> <td>D-A9□(V) (Excludes the D-A93)</td> <td>0.10 to 0.20</td> </tr> </tbody> </table>	Auto switch model	Tightening torque	D-M9□(V)	0.05 to 0.15	D-M9□W(V)	D-A93	D-M9□A(V)	0.05 to 0.10	D-A9□(V) (Excludes the D-A93)	0.10 to 0.20	<ol style="list-style-type: none"> Insert the nut into the auto switch mounting slot on the cylinder tube, and place it in the roughly estimated setting position. Engage the ridge on the auto switch mounting arm with the recess in the cylinder tube rail, and slide it to the position of the nut. Gently screw the auto switch mounting screw into the thread of the auto switch mounting nut through the mounting hole on the auto switch mounting arm. Confirm where the mounting position is, and tighten the auto switch mounting screw to fix the auto switch. The tightening torque of the M2.5 screw must be 0.25 to 0.35 N·m. The detecting position can be changed under the conditions in step ③. 	<ol style="list-style-type: none"> Insert the nut into the auto switch mounting slot on the cylinder tube, and place it in the roughly estimated setting position. With the lower tapered part of the auto switch spacer facing the outside of the cylinder tube, line up the M2.5 through hole with the M2.5 female of the auto switch mounting nut. Gently screw the auto switch mounting nut fixing screw (M2.5) into the thread of the auto switch mounting nut through the mounting hole. Engage the ridge on the auto switch mounting arm with the recess in the auto switch spacer. Tighten the auto switch mounting screw (M3) to fix the auto switch. The tightening torque of the M3 screw must be 0.35 to 0.45 N·m. Confirm where the mounting position is, and tighten the auto switch fixing screw (M2.5) to fix the auto switch mounting nut. The tightening torque of the M2.5 screw must be 0.25 to 0.35 N·m. The detecting position can be changed under the conditions in step ⑤. Auto switch mounting screw (M3 x 0.5 x 8L) 	<ol style="list-style-type: none"> Insert the auto switch into the slot on the cylinder tube. Confirm where the detecting position is, and tighten the hexagon socket head cap screw (M2.5 x 12L) to fix the auto switch. If the detecting position is changed, go back to step ①. <ul style="list-style-type: none"> Ensure that the auto switch is inserted into the auto switch mounting slot to protect the auto switch. The tightening torque for the hexagon socket head cap screw (M2.5 x 12L) is 0.2 to 0.3 N·m. 
Auto switch model	Tightening torque													
D-M9□(V)	0.05 to 0.15													
D-M9□W(V)														
D-A93														
D-M9□A(V)	0.05 to 0.10													
D-A9□(V) (Excludes the D-A93)	0.10 to 0.20													

* Auto switch mounting bracket and auto switch are enclosed with the cylinder for shipment.
 For an environment that needs the water-resistant auto switch, select the D-M9□A(V) type.
 Auto switch mounting bracket for the D-F7BA(V) model uses BQ4-012 and BQ5-032 normal specifications (metal screw).

Auto Switch Mounting Brackets/Part Nos.

[Stainless Steel Mounting Screw]

The following stainless steel mounting screw kit (including nuts) is available. Use it in accordance with the operating environment. (Please order BQ-2 separately, since auto switch spacers (for BQ-2) are not included.)

BBA2: For D-A7/A8/F7/J7 models

The stainless steel screws above are used when a cylinder is shipped with the D-F7BA/F7BAV auto switches. When only one auto switch is shipped independently, the BBA2 is attached.

- * When mounting D-M9□A(V) on a port other than the ports for ø32, ø40, and ø50, order auto switch mounting brackets BQ2-012S, BQ-2, and stainless steel screw set BBA2 separately.
- * Refer to page 1443 for details on the BBA2.

Auto Switch Mounting Bracket Weight

Auto switch mounting bracket part no.	Weight [g]
BQ-1	1.5
BQ-2	1.5
BQ2-012	5

Other than the applicable auto switches listed in "How to Order," the following auto switches are also mountable.

Other Applicable Auto Switches (Refer to pages 1341 to 1435 for further information on auto switches.)

Type	Model	Electrical entry	Features
Reed	D-A73	Grommet (Perpendicular)	—
	D-A80		Without indicator light
	D-A73H, A76H	Grommet (In-line)	—
	D-A80H		Without indicator light
Solid state	D-F7NV, F7PV, F7BV	Grommet (Perpendicular)	—
	D-F7NWW, F7BWV		Diagnostic indication (2-color indicator)
	D-F7BAV		Water-resistant (2-color indicator)
	D-F79, F7P, J79	Grommet (In-line)	—
	D-F79W, F7PW, J79W		Diagnostic indication (2-color indicator)
	D-F7BA		Water-resistant (2-color indicator)
	D-F7NT		With timer

- * With pre-wired connector is also available for solid state auto switches. For details, refer to pages 1410 and 1411.
- * Normally closed (NC = b contact) solid state auto switches (D-M9□E(V)) are also available. For details, refer to page 1360.

Stopper Cylinder/Adjustable Mounting Height

RSG Series

ø40, ø50

How to Order

With auto switch RSDG 40 - 30 D - M9BW - C

With auto switch (Built-in magnet) RSG 40 - 30 D

Bore size

40	40 mm
50	50 mm

Port type

Nil	Rc
TN	NPT
TF	G
F	Built-in One-touch fittings

Cylinder stroke (mm)

40, 50	20, 25, 30
--------	------------

Action

D	Double acting
B	Double acting with spring loaded
T	Single acting (Spring extend)

Number of auto switches

Nil	2 pcs.
S	1 pc.

Auto switch

Nil	Without auto switch
-----	---------------------

Made to Order Specifications
For details, refer to page 623.

Auto switch mounting bracket^{Note)}
Note) This symbol is indicated when the D-A9□ or M9□ type auto switch is specified. This mounting bracket does not apply to other auto switches (D-C7□ and H7□, etc.) (Nil)

Rod end configuration

Symbol	Configuration	Application
Nil	Round bar type	—
K	Chamfered type	—
R	Roller type	—
L	Lever type (Non-adjustable)	Basic type
B	Lever type (Energy absorbing Adjustable deformation)	—
C		With cancel cap
D		With lock mechanism
E		With lock & cancel

Built-in Magnet Cylinder Model

If a built-in magnet cylinder without an auto switch is required, there is no need to enter the symbol for the auto switch. (Example) RSDG50-25D

Applicable Auto Switches/Refer to pages 1341 to 1435 for further information on auto switches.

Type	Special function	Electrical entry	Indicator/light	Wiring (Output)	Load voltage		Auto switch model		Lead wire length (m)					Pre-wired connector	Applicable load			
					DC	AC	Perpendicular	In-line	0.5 (Nil)	1 (M)	3 (L)	5 (Z)	None (N)					
Solid state auto switch	—	Grommet	No	3-wire (NPN)	5 V, 12 V	—	M9NV	M9N	●	—	●	○	—	○	IC circuit	Relay, PLC		
				3-wire (PNP)			M9PV	M9P	●	—	●	○	—	○				
		Connector		2-wire	M9BV		M9B	●	—	●	○	—	○					
				—	H7C		●	—	●	○	—	○						
	Diagnostic indication (2-color indicator)	Grommet	Yes	3-wire (NPN)	5 V, 12 V		M9NWV	M9NW	●	●	●	○	—	○			IC circuit	Relay, PLC
				3-wire (PNP)			M9PWV	M9PW	●	●	●	○	—	○				
		Connector		2-wire	M9BWW		M9BW	●	●	●	○	—	○					
				—	H7NF		●	—	●	○	—	○						
Water resistant (2-color indicator)	Grommet	Yes	3-wire (NPN)	5 V, 12 V	M9NAV*1	M9NA*1	○	○	●	○	—	○	IC circuit	Relay, PLC				
			3-wire (PNP)		M9PAV*1	M9PA*1	○	○	●	○	—	○						
	Connector		2-wire	M9BAV*1	M9BA*1	○	○	○	○	—	○							
			4-wire (NPN)	—	H7NF	●	—	●	○	—	○							
Reed auto switch	—	Grommet	No	3-wire (NPN equivalent)	5 V	—	A96V	A96	●	—	●	—	—	IC circuit	—			
				2-wire			A93V*2	A93	●	●	●	—	—					
		Connector		12 V	100 V or less		A90V	A90	●	—	●	—	—					
					24 V or less		—	C73C	●	—	●	●	—					
Connector	12 V	24 V or less	—	C80C	●	—	●	●	—									

*1 Water resistant type auto switches can be mounted on the above models, but in such case SMC cannot guarantee water resistance.

Consult with SMC regarding water resistant types with the above model numbers.

*2 1 m type lead wire is only applicable to D-A93.

* Lead wire length symbols: 0.5 m..... Nil (Example) M9NW
1 m..... M (Example) M9NW
3 m..... L (Example) M9NW
5 m..... Z (Example) M9WZ
None..... N (Example) H7CN

* Solid state auto switches marked with "○" are produced upon receipt of order.

* Since there are other applicable auto switches than listed, refer to page 633 for details.

* For details about auto switches with pre-wired connector, refer to pages 1410 and 1411.

* D-A9□/M9□/M9□W auto switches are shipped together (not assembled). (Only auto switch mounting brackets are assembled before shipped.)

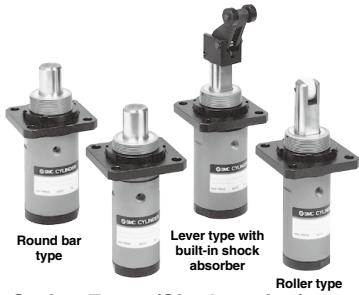

Spring Force (Single acting)

Bore size (mm)	Extended	Compressed
40, 50	13.7	27.5

(N)

* For Round bar type, Chamfered type and Roller type.

Symbol

Rubber bumper

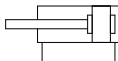

Made to Order Specifications

[Click here for details](#)

Symbol	Specifications
-XA□	Change of rod end shape
-XC3	Special port position

Model

Bore size (mm)		40	50
Mounting	Flange	●	●
Built-in magnet		●	●
Piping	Screw-in type	Rc 1/8	
	Built-in One-touch fittings	ø6/4	ø8/6
Action		Double acting, Single acting (Spring extended), Double acting with spring loaded	
Rod end configuration	Round bar type	●	●
	Chamfered type	●	●
	Roller type	●	●
	Lever type	●	●

Specifications

Action	Double acting, Double acting with spring loaded, Single acting (Spring extended)
Fluid	Air
Proof pressure	1.5 MPa
Maximum operating pressure	1.0 MPa
Ambient and fluid temperature	Without auto switch: -10 to 70°C* With auto switch: -10 to 60°C
Lubrication	Not required (Non-lube)
Cushion	Rubber bumper
Stroke length tolerance	+1.4 0
Mounting	Flange type

* No freezing (for cylinders with or without an auto switch)

Bore Size/Standard Stroke

Bore size (mm)	Rod end configuration	
	40	Round bar type, Chamfered type, Roller type, Lever type with shock absorber
50	20, 25, 30	

(mm)

Weight

Action	Bore size (mm)	Rod end configuration	Cylinder stroke (mm)		
			20	25	30
Double acting Single acting, Spring extend	40	Round bar type, Chamfered type, Roller type	1.14	1.17	1.2
		Lever type with built-in shock absorber	1.38	1.41	1.44
Double acting with spring loaded	50	Round bar type, Chamfered type, Roller type	1.34	1.37	1.4
		Lever type with built-in shock absorber	1.56	1.59	1.62

(kg)

Operating Ranges by Rod End Configuration

(Example 1) For roller type with transfer speed of 15 m/min. and the weight of transferred object of 30 kg.

<How to read the graphs>

To select a cylinder based on the specifications above, find the intersection of the speed of 15 m/min. on the horizontal axis and the weight of 30 kg on the vertical axis in graph (1) below, and select RSG□40-□□R that falls in the cylinder operating range.

(Example 2) Transfer speed of 15 m/min., Weight of transferred object of 60 kg, Friction coefficient $\mu = 0.1$, Lever type (Lever type with lock mechanism)

<How to read the graphs>

To select a cylinder based on the specifications above, find the intersection of the speed of 15 m/min. on the horizontal axis and the weight of 60 kg on the vertical axis in graph (3) below, and select RSG□40-□□D that falls in the cylinder operating range.

Roller Type/Round Bar Type/ Chamfered Type

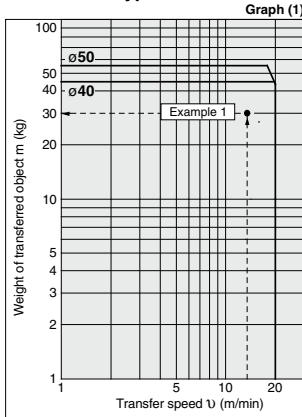

Lever Type (With shock absorber) Friction coefficient $\mu = 0$

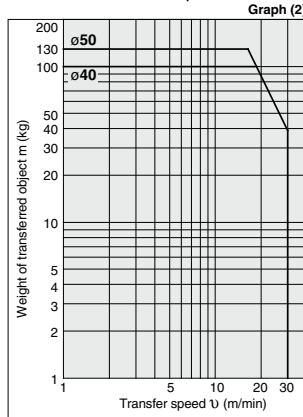

Lever Type (With shock absorber) Friction coefficient $\mu = 0.1$

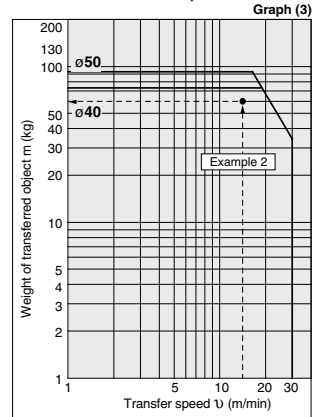

- * Lever-type weight of transferred object and transfer speed graphs (graphs (2) and (3)) show the values at room temperature (20 to 25°C).
- * When selecting cylinders, confirm the Specific Product Precautions as well.

Lateral Load and Operating Pressure

The larger the lateral load, the higher the operating pressure required for the stopper cylinder. Set the operating pressure using the graphs as a guide.

(Applicable for round bar, roller and chamfered type rod end configurations.)

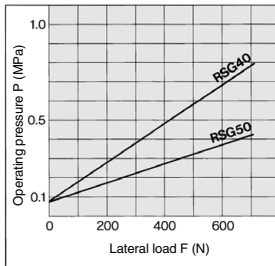

Construction

Roller rod end

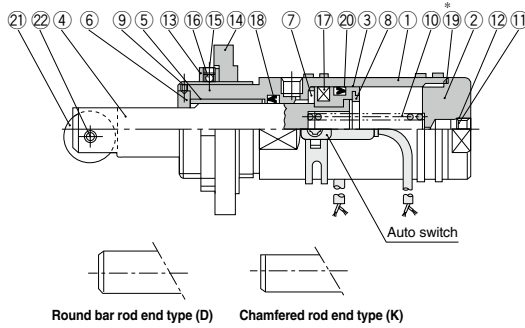

Lever rod end with shock absorber type (Fixed)

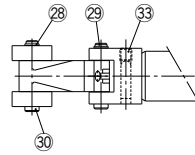

Lever rod end type (With lock mechanism and cancel cap)

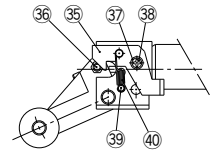
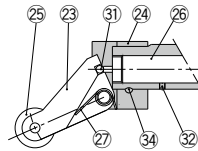
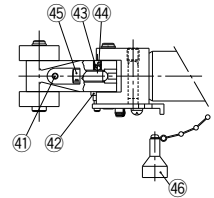

Component Parts

No.	Description	Material	Note
1	Tube cover	Aluminum alloy	Hard anodized
2	Head cover	Aluminum alloy	Anodized
3	Piston	Aluminum alloy	Chromated
4	Piston rod	Carbon steel	Hard chrome plated
5	Bushing	Bearing alloy	
6	Non-rotating guide	Rolled steel	Use collar for round bar type.
7	Bumper A	Urethane	
8	Bumper B	Urethane	
9	Hexagon socket head set screw	Chromium molybdenum steel	
10	Return spring	Steel wire	Zinc chromated (Except double acting)
11	Retaining ring	Carbon tool steel	(Single acting only)
12	Element	Sintered metallic BC	(Single acting only)
13	Lock nut	Carbon steel	
14	Flange	Cast iron	
15	Hexagon socket head set screw	Chromium molybdenum steel	
16	Ball	Resin	
17	Magnet	—	
18	Rod seal	NBR	
19	Gasket	NBR	Used Only for double acting and double acting with spring loaded.
20	Piston seal	NBR	

Replacement Parts/Seal Kit

Bore size (mm)	Kit no.			Contents
	Double acting	Double acting with spring loaded	Single acting	
40	RSG40D-PS	RSG40B-PS	RSG40T-PS	Set of above nos.
50	RSG50D-PS	RSG50B-PS	RSG50T-PS	⑬, ⑰, ⑳

* Seal kit includes ⑬, ⑰, ⑳. Order the seal kit, based on each bore size.

* Since the seal kit does not include a grease pack, order it separately.

Grease pack part no.: GR-S-010 (10 g)

Component Parts

No.	Description	Material	Note
Roller type			
21	Roller A	Resin	
22	Spring pin	Carbon tool steel	
Lever type			
23	Lever	Cast iron	
24	Lever holder	Rolled steel	
25	Roller B	Resin	
26	Shock absorber	—	RB1407-X552
27	Lever spring	Stainless steel wire	
28	Type C retaining ring for shaft	Carbon tool steel	
29	Lever pin	Carbon steel	
30	Roller pin	Carbon steel	
31	Steel balls	High carbon chrome bearing steel	
32	Hexagon socket head set screw	Chromium molybdenum steel	
33	Hexagon socket head set screw	Chromium molybdenum steel	
34	One-side tapered pin	Carbon steel	

With lock mechanism

35	Bracket	Carbon steel	
36	Pin B	Carbon steel	
37	Spacer	Carbon steel	
38	Round head Phillips screw	Rolled steel	
39	Pin A	Rolled steel	
40	Bracket spring	Steel wire	
41	Hexagon socket head cap set screw	Chromium molybdenum steel	
42	Spring washer	Steel wire	
43	Urethane ball	Urethane	
44	Hexagon socket head cap set screw	Chromium molybdenum steel	
45	Adjustment bolt	Bearing steel	

With cancel cap

46	Cancel cap	Aluminum alloy	
----	------------	----------------	--

Replacement Parts: Shock Absorber

Bore size (mm)	Kit no.
40, 50	RB1407-X552

RSG Series

Rod End Configuration: Round Bar Type

Basic type: Flange mounting

These 2 figures show the piston rod extended.

Bore size: $\varnothing 40, \varnothing 50$ RS□G□-□□

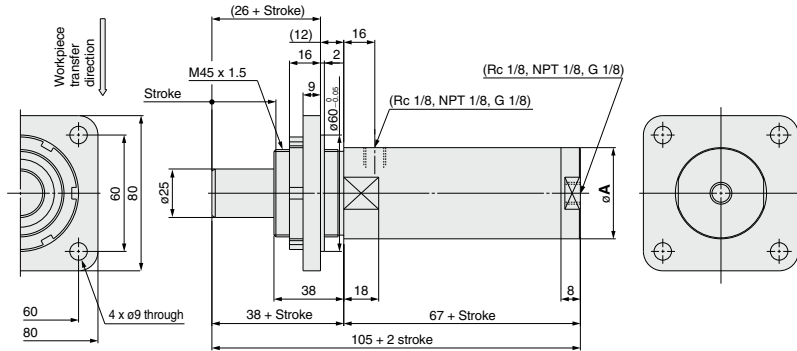

Built-in One-touch fittings

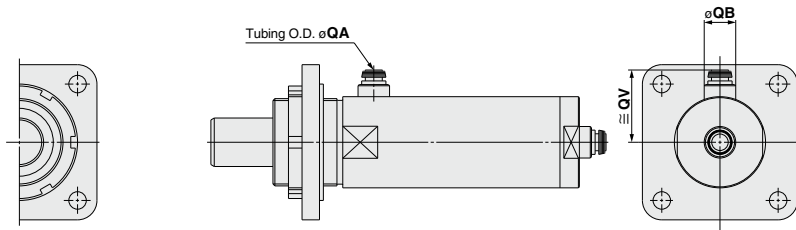

(mm)

Bore size (mm)	A	QA	QB	QV
40	47	6	13	33
50	58	8	16	38.5

Note 1) In the case of single acting type, a One-touch fitting is on the rod side only.

Note 2) These figures show the piston rod extended.

Note 3) For the auto switch mounting position and its mounting height, refer to page 632.

Rod End Configuration: Chamfered Type (Non-rotating piston rod)

Basic type: Flange mounting

These 2 figures show the piston rod extended.

Bore size: $\varnothing 40, \varnothing 50$ RS□G□-□□K

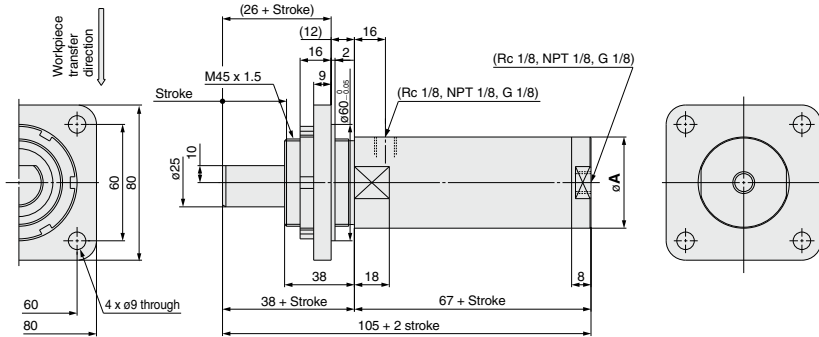

Built-in One-touch fittings

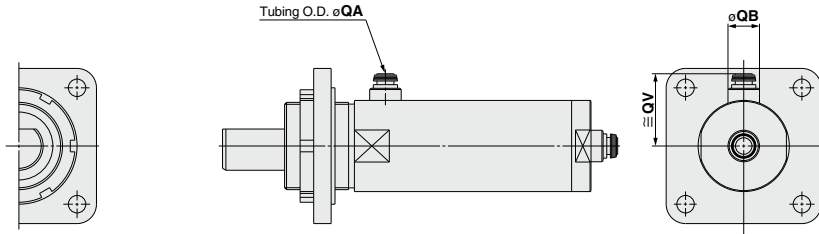

(mm)

Bore size (mm)	A	QA	QB	QV
40	47	6	13	33
50	58	8	16	38.5

Note 1) In the case of single acting type, a One-touch fitting is on the rod side only.

Note 2) These figures show the piston rod extended.

Note 3) For the auto switch mounting position and its mounting height, refer to page 632.

RSG Series

Rod End Configuration: Roller Type

Basic type: Flange mounting

These 2 figures show the piston rod extended.

Bore size: $\varnothing 40$, $\varnothing 50$ RS□G□-□□R

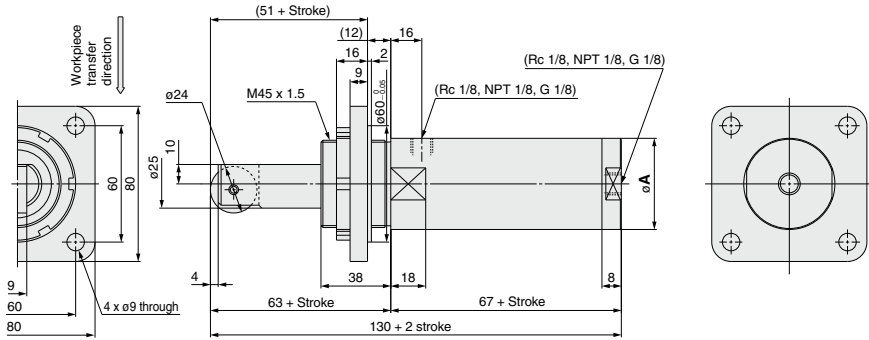

Built-in One-touch fittings

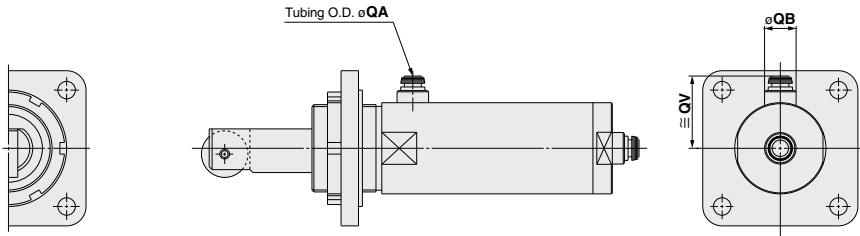

(mm)				
Bore size (mm)	A	QA	QB	QV
40	47	6	13	33
50	58	8	16	38.5

Note 1) In the case of single acting type, a One-touch fitting is on the rod side only.

Note 2) These figures show the piston rod extended.

Note 3) For the auto switch mounting position and its mounting height, refer to page 632.

Rod End Configuration: Lever Type with Shock Absorber

Basic type: Flange mounting

These 2 figures show the piston rod extended.

Bore size: $\phi 40, \phi 50$ RS□G□-□□L

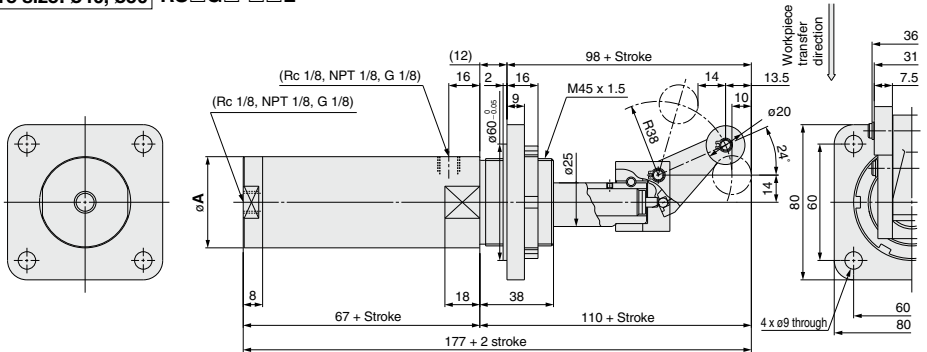

Built-in One-touch fittings

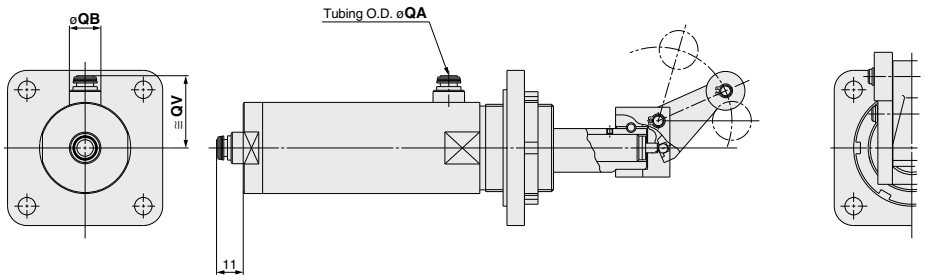

(mm)				
Bore size (mm)	A	QA	QB	QV
40	47	6	13	33
50	58	8	16	38.5

Note 1) In the case of single acting type, a One-touch fitting is on the rod side only.
 Note 2) These figures show the piston rod extended.
 Note 3) For the auto switch mounting position and its mounting height, refer to page 632.

Rod End Configuration: Lever Type with Shock Absorber

Variable energy absorbing type/Flange mounting type

These 2 figures show the piston rod extended.

Adjustable shock absorber stroke RS□G□-□□B

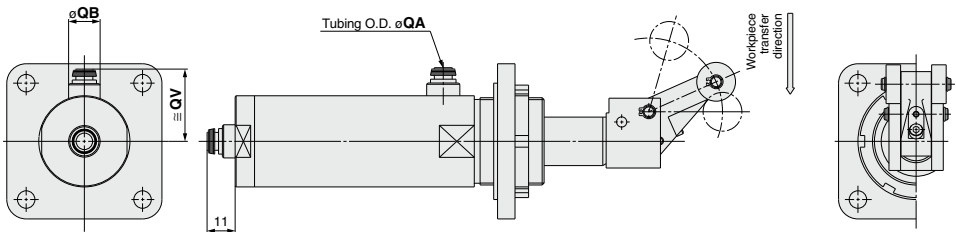
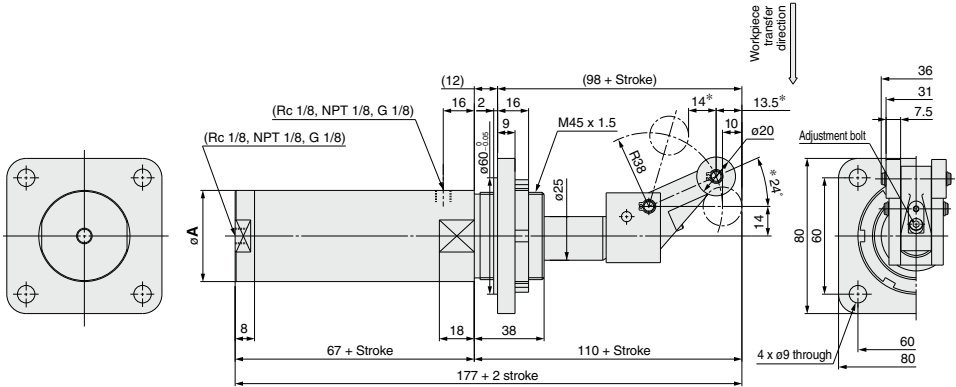

With cancel cap RS□G□-□□C

* Dimensions when equipped with cancel cap are the same as the drawing above.

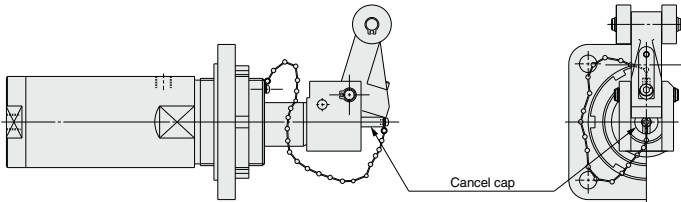

		(mm)			
Bore size (mm)	A	QA	QB	QV	
40	47	6	13	33	
50	58	8	16	38.5	

Note 1) In the case of single acting type, a One-touch fitting is on the rod side only.

Note 2) These figures show the piston rod extended.

Note 3) For the auto switch mounting position and its mounting height, refer to page 632.

Note 4) The figure shows these dimensions when the adjustment bolt is lowered (when energy absorption is at its maximum).

However, these dimensions change within the ranges shown below as the adjusting bolt is raised (energy absorption is reduced).

24° → 16°, 13.5° → 11.5°, 14° → 16°

Rod End Configuration: Lever Type with Shock Absorber

Variable energy absorbing type/Flange mounting type

These 2 figures show the piston rod extended.

With lock mechanism **RS□G□-□□D**

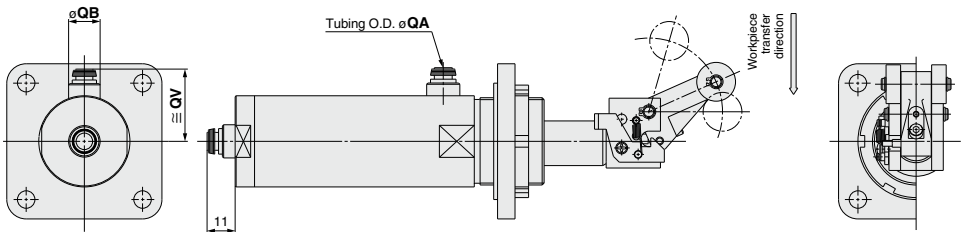
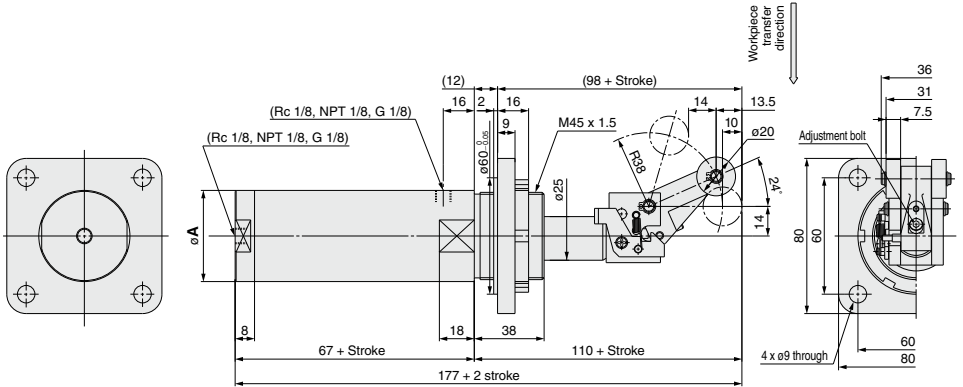

With lock mechanism + Cancel cap **RS□G□-□□E**

* Dimensions when equipped with lock and cancel cap are the same as the figure drawing.

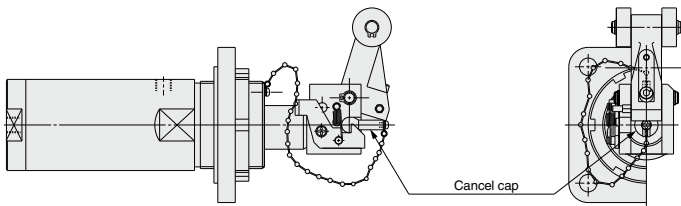

Bore size (mm)	A	QA	QB	QV
40	47	6	13	33
50	58	8	16	38.5

Note 1) In the case of single acting type, a One-touch fitting is on the rod side only.

Note 2) These figures show the piston rod extended.

Note 3) The figure shows these dimensions when the adjustment bolt is lowered (when energy absorption is at its maximum).

However, these dimensions change within the ranges shown below as the adjusting bolt is raised (energy absorption is reduced).

24° → 16°, 13.5° → 11.5°, 14° → 16°

Auto Switch Mounting

Auto Switch Proper Mounting Position (Detection at Stroke End) and Its Mounting Height

Reed Auto Switch

D-A9□

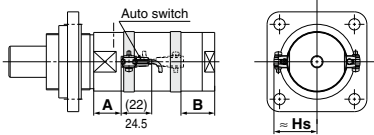

(): For D-A96 type

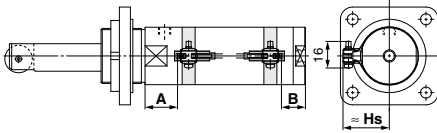

D-C7
D-C8
D-C73C
D-C80C

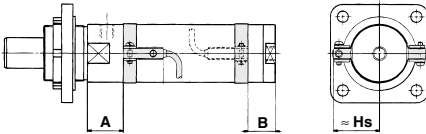

Solid State Auto Switch

D-M9□
D-M9□W
D-M9□A

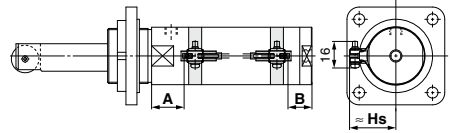
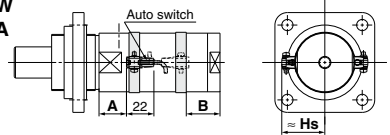

D-H7
D-H7□W
D-H7NF
D-H7BA
D-H7C

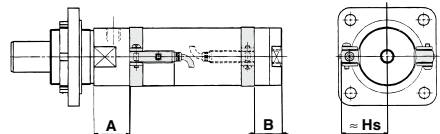

Auto Switch Proper Mounting Position (mm)

Auto switch model	(mm)							
	D-A9□ (Note 2)		D-M9□(V) (Note 2)		D-C7□		D-H7BA	
Bore size (mm)	A	B	A	B	A	B	A	B
	40	21.5	25.5	25.5	29.5	22.0	26.0	21.0
50	29.5	17.5	33.5	21.5	30.0	18	29.0	17.0

Auto Switch Mounting Height (mm)

Auto switch model	(mm)				
	D-M9□V	D-M9□WV	D-M9□AV	D-M9□A	D-A9□
Bore size (mm)	Hs	Hs	Hs	Hs	Hs
	40	36.0	35.0	38.0	37.5
50	41.5	40.5	43.5	43.0	43.0

Note 1) Adjust the auto switch after confirming the operating conditions in the actual setting.
Note 2) Auto switch mounting (The adjustment as shown in the figures below is required)

Auto switch model	With 2 auto switches	
	Different surfaces	Same surface
	<p>The proper auto switch mounting position is 6 mm inward from the switch holder edge.</p>	<p>The auto switch is mounted by slightly displacing it in a direction (cylinder tube circumferential exterior) so that the auto switch and lead wire do not interfere with each other.</p>

Operating Range

Auto switch model	Bore size (mm)	
	40	50
D-A9□(V)	8	8
D-M9□(V) D-M9□W(V) D-M9□A(V)	4.5	5
D-C7□/C80 D-C73C/C80C	10	10
D-H7□/H7□W D-H7BA/H7NF	5	6
D-H7C	10	9.5

* Since this is a guideline including hysteresis, not meant to be guaranteed. (Assuming approximately ±30% dispersion) There may be the case to change substantially depending on an ambient environment.

Auto Switch Mounting Bracket: Part No.

Auto switch model	Bore size (mm)	
	ø40	ø50
D-A9□(V) D-M9□(V) D-M9□W(V)	Note 1) BMA3-040	Note 1) BMA3-050
D-M9□A(V)	Note 2) BMA3-040S	Note 2) BMA3-050S
D-C7□/C80 D-C73C/C80C D-H7□ D-H7□W D-H7BA D-H7NF	BMA2-040A	BMA2-050A

Note 1) Set part number which includes the auto switch mounting band (BMA2-□□□A) and the holder kit (BJ5-1/Switch bracket: Transparent). Since the switch bracket (made from nylon) are affected in an environment where alcohol, chloroform, methylamines, hydrochloric acid or sulfuric acid is splashed over, so it cannot be used. Please consult SMC regarding other chemicals.

Note 2) Set part number which includes the auto switch mounting band (BMA2-□□□AS/Stainless steel screw) and the holder kit (BJ4-1/Switch bracket: White).

Note 3) For the D-M9 A(V) type auto switch, do not install the switch bracket on the indicator light.

[Mounting screw set made of stainless steel]

The following set of mounting screws made of stainless steel is available. Use it in accordance with the operating environment. (Please order the auto switch mounting bracket separately, since it is not included.)

D-H7BA auto switch is set on the cylinder with the stainless steel screws above when shipped. When an auto switch is shipped independently, BBA4 is attached.

Note 4) Refer to page 1440 for the details of BBA4.

- (1) BJ□-1 is a set of "a" and "b".
BJ4-1 (Switch bracket: White)
BJ5-1 (Switch bracket: Transparent)
- (2) BMA2-□□□A(S) is a set of "c" and "d".
Band (c) is mounted so that the projected part is on the internal side (contact side with the tube).

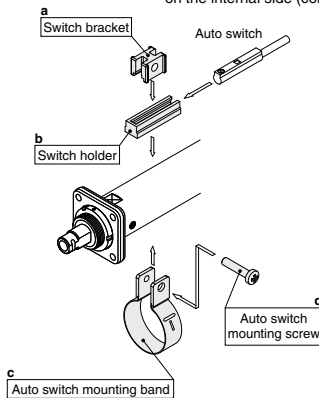

Besides the models listed in How to Order, the following auto switches are applicable. Refer to pages 1341 to 1435 for detailed specifications.

Auto switch type	Part no.	Electrical entry (Direction)	Features
Reed	D-C73, C76	Grommet (In-line)	—
	D-C80		Without indicator light
Solid state	D-H7A1, H7A2, H7B		—
	D-H7NW, H7PW, H7BW		Diagnostic indication (2-color)
	D-H7BA		

* For solid state auto switches, auto switches with a pre-wired connector are also available. Refer to pages 1410 and 1411 for details.

* Normally closed (NC = b contact) solid state auto switches (D-M9□E(V)) are also available. Refer to page 1360 for details.



RSQ/RSG Series

Specific Product Precautions 1

Be sure to read this before handling the products.

Refer to page 9 for safety instructions and pages 10 to 19 for actuator and auto switch precautions.

Selection

⚠ Danger

1. Use within the range of specifications.

If used beyond the specifications, excessive impacts or vibrations could be applied to the stopper cylinder and might cause breakage.

⚠ Caution

1. Do not allow a pallet to collide with the cylinder when the lever is upright.

In the case of the lever type with built-in shock absorber, if the next pallet runs into the lever when it is in the upright position (after the shock absorber has assimilated energy), the cylinder body will receive the full energy of the impact, and this should not be permitted.

2. Do not apply pressure from the head side of a single acting type cylinder.

If air is supplied from the head side of a single acting cylinder, blow-by of the air will occur.

3. Do not scratch or gouge the sliding portion of a piston.

Quenching of the piston rod has not been performed. If there is a danger of scratching or nicking the piston rod due to sharp edges, etc. on the contact area of a pallet, the pallet should not be used, as this can cause a malfunction.

4. When using a stopper cylinder for intermediate stopping of a load connected directly to a cylinder, etc.

The operating ranges shown in this catalog apply only for stopping of a pallet on a conveyor. When using a stopper cylinder to stop a load connected directly to a cylinder, etc., the cylinder thrust will become a lateral load. In this case, refer to the operation manual and select a cylinder remaining within the allowable energy and allowable lateral load ranges.

5. For the lever type with a built-in shock absorber (without a lock mechanism), the lever may be pushed back in the opposite direction to the transfer direction due to the return force of the shock absorber, if 10N of thrust or more in the transfer direction is not applied to the lever after the pallet collides with the lever.

If the lever must be continuously upright, select a lever with a lock mechanism.

6. The operating range for the lever type with a built-in shock absorber indicates the range in which the lever is not damaged due to the shock absorber's performance and cylinder rigidity. It is not the same as the range in which the lever can stop softly and fully.

Near the upper limit, collision may occur at the end. If a soft stop is required, sufficient clearance is necessary. Consult with SMC when a reliable soft stop is required near the upper limit.

Mounting

⚠ Caution

1. Do not apply rotational torque to the cylinder rod.

In order to prevent rotational torque from acting upon the cylinder rod, mount it so that the contacting surfaces of the pallet and cylinder are parallel to one another.

When mounting a cylinder, tighten the body lock nut, and then tighten the set screws (2 locations) which are included with the lock nut. (Except RSQ)

2. When the lever type with a built-in shock absorber is installed from the direction of the lever side, mounting holes must be machined in accordance with recommend hole diameters in the table below.

When it is installed from the direction of the lever side of the stopper cylinder as shown below, note that the lever's outer

Mounting

⚠ Caution

diameter is larger than the rod cover boss diameter.

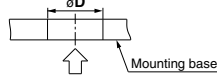

Lever type models

RS (D) □32/40/50-□□L
RS (D) □32/40/50-□□B
RS (D) □32/40/50-□□C
RS (D) □32/40/50-□□D
RS (D) □32/40/50-□□E

Table 1 Recommended hole diameter

Model	Recommended hole diameter for mounting base	
	oT	oD
RS (D) □32	36	38
RS (D) □40	44	48
RS (D) □50	56	57

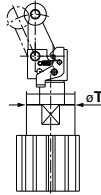

Figure 1

Operation

⚠ Caution

1. For the lever type model with a lock mechanism, do not remove the grease applied to the pin B and the bracket.

When using the cylinder continuously with no grease applied, the lock and unlock may not operate correctly due to unusual wear of the pin B or rod cover.

Check the grease application state periodically and apply the grease when necessary. The grease to be applied is available as grease pack. When the grease pack is required, order it using the part number shown below.

Grease pack part number: GR-S-010 (10 g)

(* The grease to be applied is the same as that used for the cylinder.)

Similarly, be careful not to remove the grease from the piston rod end of the built-in shock absorber. Check the grease application state periodically.

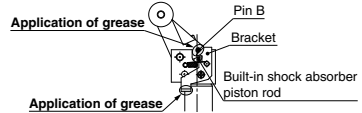

2. For models having the rod end configuration with the lever type with lock mechanism, do not apply any external force from the opposite side when the lever is locked. Doing so may cause the lock mechanism to break.

When moving pallets during conveyor adjustments, first lower the cylinder.

3. Some structural backlash is present in the lever lock mechanism.

As the stopping position of the pallet can be affected by the weight of the object being transferred, the operating conditions of the conveyor, etc., the stopping position may vary. Please contact SMC if a higher level of stopping accuracy is required for the pallet.

4. Do not use oil, etc. on the sliding parts of the piston rod.

This can cause trouble with retraction or other malfunctions.

5. Do not get your hands caught during cylinder operation.

Since the lever section moves up and down when the cylinder is in operation, take sufficient care to avoid getting your hands caught between the rod cover and the lever holder.

6. Do not expose the shock absorber to machining oil, water, or dust.

This can cause oil leakage and malfunction of the shock absorber.



RSQ/RSG Series

Specific Product Precautions 2

Be sure to read this before handling the products.

Refer to page 9 for safety instructions and pages 10 to 19 for actuator and auto switch precautions.

Maintenance

⚠ Caution

1. How to replace the shock absorber

- 1) Loosen the hexagon socket head set screw (M3) on the piston rod.

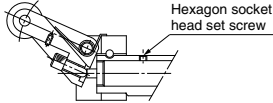

- 2) With the lever laid down as shown in the figure, pull out the shock absorber to remove it and replace this shock absorber with a new one.

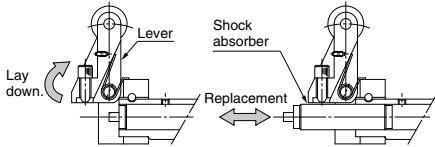

- 3) Insert the hexagon socket head set screw into the piston rod, and then tighten it.
After the hexagon socket head set screw has been in contact with the end, tighten it further 1/4 turn as a guideline. If the hexagon socket head set screw is tightened excessively, this may cause it to break or the shock absorber to malfunction.
Tightening torque: 0.29 N·m
- 4) After replacement, apply grease to the piston rod end of the shock absorber.

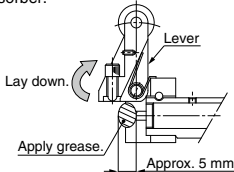

2. How to change the piston rod orientation

For the roller type and lever type, put the pallet in contact with the piston rod in the direction shown in the figure. (The piping port position has been made flush with the pallet contact surface at the factory shipment.)

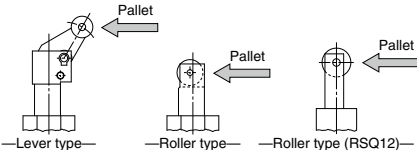

RSQ12 / How to change the piston rod orientation

- 1) Loosen the hexagon socket head cap screws (2 locations) that secure the rod cover and cylinder tube.
- 2) Adjust the orientation of the rod cover to a desired position.
The orientation of the rod cover can be changed in 90° steps.
- 3) Tighten two hexagon socket head cap screws on the diagonal line to secure the rod cover and cylinder tube.
When tightening the hexagon socket head cap screws, apply the thread locking agent.
Tightening torque: 1.5 N·m
- 4) Make sure that the cylinder operates smoothly.

⚠ Caution

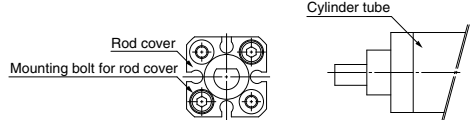

RSQ20 to 50 / How to change the piston rod orientation

- 1) Loosen two hexagon socket head cap screws (M3) on the rod cover that secure the non-rotating guide.
- 2) Adjust the orientation of the piston rod to a desired position.
Note) Put the pallet contact surface in parallel to the cylinder contact surface so that the rotational torque does not apply to the piston rod.
- 3) Tighten two hexagon socket head cap screws to secure the non-rotating guide. When tightening the hexagon socket head cap screws, apply the thread locking agent.
Tightening torque: 0.63 N·m
Note) The non-rotating guide is secured by two hexagon socket head cap screws. If one hexagon socket head cap screw is tightened excessively, the non-rotating guide may be in contact with the piston rod, causing malfunction. Therefore, tighten the hexagon socket head cap screws alternately and pay special attention so that the non-rotating guide is not in contact with the piston rod.
- 4) Make sure that the cylinder operates smoothly.

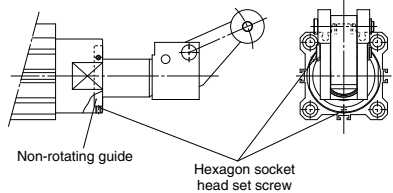

3. How to adjust the lever type, variable energy absorbing type

For the lever type, variable energy absorbing type, strokes of the shock absorber can be adjusted with an adjustment bolt included in order to stop in accordance with the transfer conditions. Follow the procedures below to adjust strokes.

Procedures

- 1) Loosen the set screw (M4) on the lever side.
- 2) Adjust the adjustment bolt in accordance with the energy of the transferred object.
(The stroke of the shock absorber becomes larger (absorbing energy becomes bigger) when tightening the adjustment bolt, while it becomes smaller when loosening the bolt.)
- 3) After adjusting the adjustment bolt, fix the bolt with the set screw (M4) loosened in 1).
Tightening torque M4: 1.5 N·m

