

Pin Clamp Cylinder

C(L)KQG□/C(L)KQP□ Series

ø50

Possible to mount on 4 surfaces, and 2 auto switches on the same surface. Improved flexibility of system design

The auto switch can be mounted in any desired position. This can reduce design labor.

Applicable Auto Switches:
Magnetic field resistant auto switch
D-P3DWA
(Only for C(L)KQG□ series)



Protrusion of auto switch shortened by 5 mm

The protrusion of the auto switch can be reduced compared with the current product. This is ideal for machine designs with small space requirements.

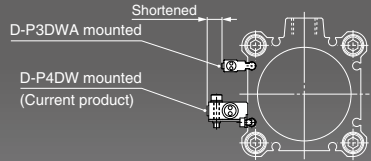

Can be mounted directly.

Mounting workability improved, as mounting brackets are not required.

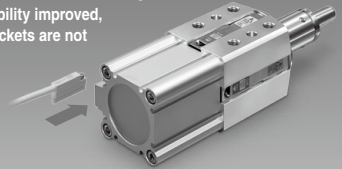

Adjustable height for clamping a workpiece

LOW type

HIGH type

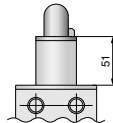
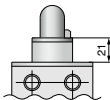

55 types of guide pins

Guide pin diameter Guide pin diameter

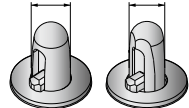

Round type Diamond type

Guide pin diameter	ø12.5 to ø30 mm
Guide pin type	*Round type: 35 types *Diamond type: 20 types
Applicable hole diameter of workpiece	ø13 to ø30 mm
Applicable type of workpiece	7 types

Application examples

Positioning Clamp and clamping at one time!

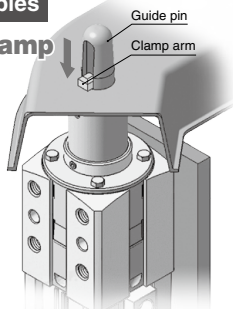

Precision adjustment of clamping height is possible by choosing the with-shim type. [Adjustment range: 0.5 to 3 mm]

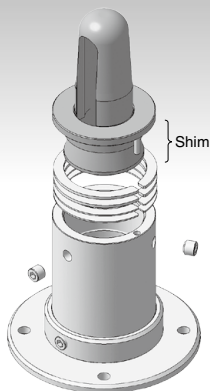

A total shim height of 3 mm consists of 2 shims with a thickness of 1 mm each and 2 shims with a thickness of 0.5 mm each. (assembled before shipping)

Optional locking mechanism is available.

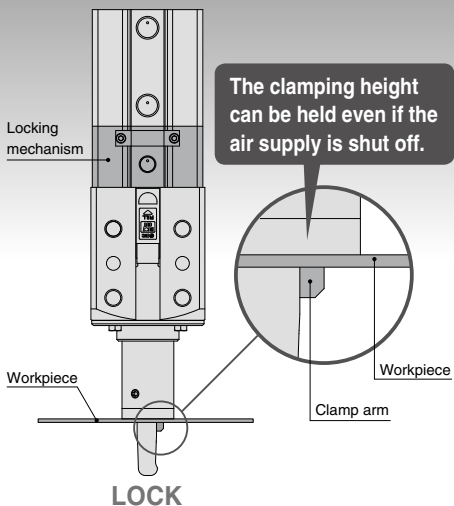

4 body types for a broad range of installation conditions

D series

Mounting tap: 4 x M10 x 1.5
Pin hole: 2 x ø8H7

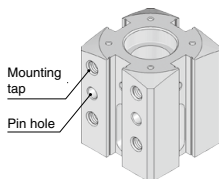

U series

Mounting tap: 2 x M10 x 1.5
Pin hole: 2 x ø8H7

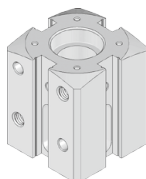

K series

Mounting tap: 2 x M10 x 1.5
Pin hole: 2 x ø10H7

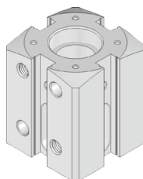

M series

Mounting tap: 2 x M12 x 1.75
Pin hole: 2 x ø10H7

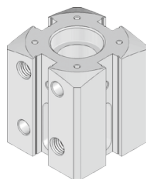



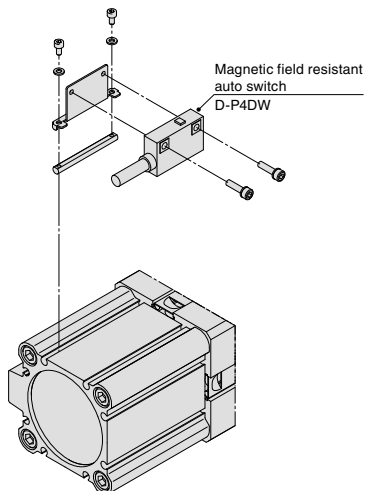



The D-P4DW auto switch is also mountable. 2 switches can be mounted on the same surface. Refer to page 536.

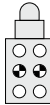
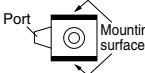
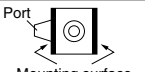

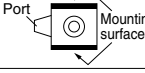
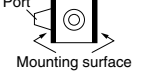
Pin Clamp Cylinder Mounting Variations

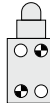
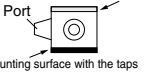
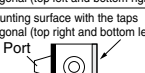
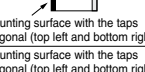
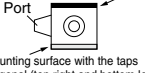
C(L)KQG□/C(L)KQP□ Series

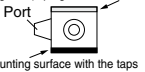
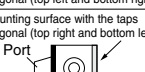
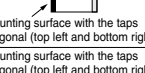
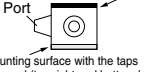
Series	Body shape symbol	Dimension	Mounting	Mounting hole (tap, pin hole) arrangement	Mounting surface (viewed from top)		Page						
					Symbol	Port location							
C(L)KQG (Built-in standard magnet) C(L)KQP (Built-in strong magnet)	D	□66	Mounting tap: 4 x M10 x 1.5 Pin hole: 2 x ø8H7	Taps are parallel.  ○: Mounting tap ⊕: Pin hole	A	 Port	518						
					B	 Port Mounting surface							
	U		Mounting tap: 2 x M10 x 1.5 Pin hole: 2 x ø8H7	Taps diagonal (top right and bottom left)  ○: Mounting tap ⊕: Pin hole	A	 Port Mounting surface	524						
					B	 Port Mounting surface							
	K		Mounting tap: 2 x M10 x 1.5 Pin hole: 2 x ø10H7	Taps diagonal (top right and bottom left)  ○: Mounting tap ⊕: Pin hole	Taps diagonal (top left and bottom right) 	C	Mounting surface with the taps diagonal (top right and bottom left)  Port Mounting surface with the taps diagonal (top left and bottom right)	528					
						D	Mounting surface with the taps diagonal (top right and bottom left)  Port Mounting surface with the taps diagonal (top left and bottom right)						
						E	Mounting surface with the taps diagonal (top left and bottom right)  Port Mounting surface with the taps diagonal (top right and bottom left)						
						F	Mounting surface with the taps diagonal (top left and bottom right)  Port Mounting surface with the taps diagonal (top right and bottom left)						
						M	Mounting tap: 2 x M12 x 1.75 Pin hole: 2 x ø10H7		Taps diagonal (top right and bottom left)  ○: Mounting tap ⊕: Pin hole	Taps diagonal (top left and bottom right) 	C	Mounting surface with the taps diagonal (top right and bottom left)  Port Mounting surface with the taps diagonal (top left and bottom right)	532
											D	Mounting surface with the taps diagonal (top right and bottom left)  Port Mounting surface with the taps diagonal (top left and bottom right)	
	E		Mounting surface with the taps diagonal (top left and bottom right)  Port Mounting surface with the taps diagonal (top right and bottom left)										
	F		Mounting surface with the taps diagonal (top left and bottom right)  Port Mounting surface with the taps diagonal (top right and bottom left)										

Pin Clamp Cylinder **D series**

CKQ_P^GD/CLKQ_P^GD Series



How to Order

Built-in standard magnet C KQG D A 50 - 177 R A L Z - P3DWASC

Built-in strong magnet C KQP D A 50 - 198 R A L - P79WSE

With lock on the clamp side

Nil	Without lock
L	With lock

Number of auto switches

Nil	2 pcs.
S	1 pc. (Unclamp side)

* The D-P7 type is different-surface mounting. (Refer to page 536.)

Mounting surface (viewed from top)

Symbol	Port location
A	
B	

Bore size

50	50 mm
----	-------

Port thread type

Nil	Rc
TN	NPT
TF	G

Guide pin diameter

* For guide pin diameter, refer to Table 1 below.

Guide pin shape

R	Round type	
D	Diamond type*	

* Diamond type guide pin diameter is $\phi 17.5$ or more.

Auto switch type

Nil	Without auto switch (Built-in magnet)
-----	---------------------------------------

* For applicable auto switch models, refer to page 519.
* Auto switches are included, (but not assembled).

Shim

Nil	Without shims
S	With 3 mm shims*

* When a model includes shims, two 1 mm shims and two 0.5 mm shims are attached.

Clamping height (Refer to the below figure.)

L	LOW type (60 mm)
H	HIGH type (90 mm)

LOW type HIGH type

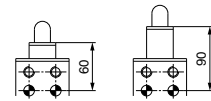

Clamping height

Body shape

Symbol	Dimension	Mounting hole (tap, pin hole) arrangement	Mounting	Mounting surface (viewed from top)
D	$\square 66$	 ○: Mounting tap ●: Pin hole	Mounting tap: 4 x M10 x 1.5 Pin hole: 2 x $\phi 8H7$	 Mounting surface (Two facing sides)

Clamp arm position (clockwise viewed from top)

Symbol	Same direction as port	180° from port
A		C
B		D

Table 1. Guide Pin Diameter

Symbol	125	127	128	129	130	145	147	148	149	150	155	157	158	159	160
Guide pin diameter	12.5	12.7	12.8	12.9	13.0	14.5	14.7	14.8	14.9	15.0	15.5	15.7	15.8	15.9	16.0
Applicable hole diameter of workpiece	For $\phi 13$					For $\phi 15$					For $\phi 16$				
Guide pin shape	Round type														

Symbol	175	177	178	179	180	195	197	198	199	200	245	247	248	249	250	295	297	298	299	300
Guide pin diameter	17.5	17.7	17.8	17.9	18.0	19.5	19.7	19.8	19.9	20.0	24.5	24.7	24.8	24.9	25.0	29.5	29.7	29.8	29.9	30.0
Applicable hole diameter of workpiece	For $\phi 18$					For $\phi 20$					For $\phi 25$					For $\phi 30$				
Guide pin shape	Round type, Diamond type																			

Table 2. Applicable Auto Switches/Refer to pages 1341 to 1435 for further information on auto switches.

Applicable cylinder series	Type	Auto switch model	Applicable magnetic field	Electrical entry	Indicator light	Wiring (Pin no in use)	Load voltage	Lead wire length	Applicable load	
C(L)KQG series	Solid state auto switch	D-P3DWASC	AC magnetic field (Single-phase AC welding magnetic field)	Pre-wired connector	2-color indicator	2-wire (3-4)	24 VDC	0.3 m	Relay, PLC	
		D-P3DWASE								2-wire (1-4)
		D-P3DWA				2-wire				
		D-P3DWAL								
		D-P3DWAZ		Pre-wired connector	2-wire (3-4)	0.3 m				
		D-P4DWSC						2-wire (1-4)		
		D-P4DWSE								2-wire
		D-P4DWL								
D-P4DWZ	3 m									
		Grommet	2-wire	5 m						
					24 VDC	0.3 m				
							24 VDC	3 m		
	100 VAC								5 m	
		DC/AC magnetic field	Pre-wired connector	2-color indicator						2-wire (1-4)
					Grommet	1-color indicator				
							24 VDC	3 m		
	5 m									

Refer to pages 536 and 537 for cylinders with auto switches.

- Auto switch proper mounting position, mounting height and operating distance
- Operating range
- Auto switch mounting

Symbol

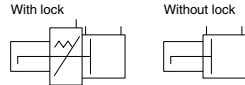

Basic Specifications

Action		Double acting	
Bore size		50 mm	
Fluid		Air	
Minimum operating pressure		CKQ□: 0.1 MPa	CLKQ□ (With lock): 0.15 MPa*
Maximum operating pressure	Guide pin diameter	ø12.5 to ø13.0	0.7 MPa
		ø14.5 to ø30.0	1.0 MPa
Proof pressure	Guide pin diameter	ø12.5 to ø13.0	1.0 MPa
		ø14.5 to ø30.0	1.5 MPa
Ambient and fluid temperature		-10 to 60°C (No freezing)	
Cushion		None	
Lubrication		Non-lube	
Piston speed (Clamp speed)		50 to 150 mm/sec	
Port size (Cylinder port)		1/4 (Rc, NPT, G)	

* Minimum operating pressure is 0.2 MPa when cylinder part and locking part use the same piping.

Lock Specifications

Locking action	Spring locking (Exhaust locking)
Unlocking pressure	0.2 MPa or more
Lock starting pressure	0.05 MPa or less
Locking direction	Lock at extended direction (Clamp holding)
Port size (Lock release port)	1/8 (Rc, NPT, G)
Holding force (Maximum static load)	982 N

Clamping Force

Model	Guide pin diameter	Operating pressure [MPa]								
		0.2	0.3	0.4	0.5	0.6	0.7	0.8	0.9	1.0
C(L)KQ ^G □	ø12.5 to ø13.0	164.9	329.8	494.7	659.6	824.5	989.4	—	—	—
	ø14.5 to ø30.0	164.9	329.8	494.7	659.6	824.5	989.4	Note 1) 1154.3	Note 1) 1319.2	Note 1) 1484.1

Note 1) Lock holding force of the CLKQ□ is 982 N. Design the circuit such that the lock holding force is taken into consideration when the operating pressure exceeds 0.75 MPa.

The operating pressure should be not greater than the lock holding force as it may cause wearing out and/or damage of the locking part and shorten lock life and may lead to possible failure if applied with a load larger than the lock holding force.

Note 2) It takes approximately 0.3 seconds for the cylinder to operate to generate clamping force from an unclamping state (when no speed controller is installed). Design circuit taking into consideration the time before the clamping force is generated.

Note 3) Determine the clamping force according to the strength of the workpiece. It can be damaged if the clamping force is too large.

Weight

Model	C(L)KQ ^G D				
	Guide pin diameter [mm]	Without lock		With lock	
		LOW	HIGH	LOW	HIGH
ø12.5 to ø13.0	1.62	1.79	2.14	2.3	
ø14.5 to ø15.0	1.62	1.79	2.14	2.3	
ø15.5 to ø16.0	1.63	1.79	2.14	2.31	
ø17.5 to ø18.0	1.67	1.84	2.18	2.36	
ø19.5 to ø20.0	1.68	1.85	2.19	2.37	
ø24.5 to ø25.0	1.74	1.94	2.25	2.46	
ø29.5 to ø30.0	1.78	1.98	2.29	2.5	

CKQ_PD/CLKQ_PD Series

Replacement Parts

■ Seal Kit (For type without lock only)

Kit no.	Contents/Quantity		
	Rod seal	Piston seal	Tube gasket
CQ2B50-PS	1	1	1

Storage of Seals (for long term storage)

- 1) Enclose seals by packaging and store.
- 2) Avoid locations exposed to direct sunlight and high temperature and humidity. In particular, isolate from equipment that can generate heat, radiation and ozone.
- 3) Do not stack a lot of seals, and deform or damage it by putting a heavy object on it.
- 4) White particles can emerge from the surface of seals during storage, but they do not affect its performance.

■ Grease Pack

Use a grease pack when adding grease during the replacement of the seals or maintenance of the cylinder.

Kit no.	Grease weight
GR-S-010	10 g

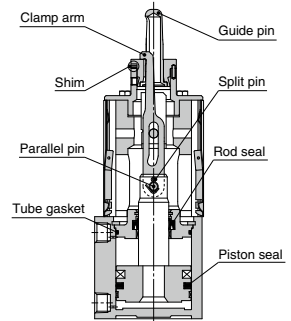

CKQ□D□50
(With shims)

■ Guide Pin Order No.

CKQG - R 125 □

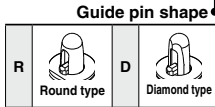

Shim	
Nil	Without shims
S	With shims*

* The guide pin comes with 1 parallel pin for positioning.

Guide pin diameter
* Refer to Table 1 (Symbol 2) below.

■ Clamp Arm Order No.

CKQG - 13 A

Applicable hole diameter of workpiece
* Refer to Table 1 (Symbol 1) below.

Clamp arm
* The clamp arm includes a split pin.

Table 1. Guide pin

Symbol 1	Applicable hole diameter of workpiece	Symbol 2	Guide pin diameter	Shape
13	13	125	12.5	Round type
		127	12.7	
		128	12.8	
		129	12.9	
		130	13.0	
15	15	145	14.5	
		147	14.7	
		148	14.8	
		149	14.9	
		150	15.0	
16	16	155	15.5	
		157	15.7	
		158	15.8	
		159	15.9	
		160	16.0	

Symbol 1	Applicable hole diameter of workpiece	Symbol 2	Guide pin diameter	Shape
18	18	175	17.5	Round type Diamond type
		177	17.7	
		178	17.8	
		179	17.9	
		180	18.0	
		20	20	
197	19.7			
198	19.8			
199	19.9			
200	20.0			
25	25			
		247	24.7	
		248	24.8	
		249	24.9	
		250	25.0	
		30	30	
297	29.7			
298	29.8			
299	29.9			
300	30.0			

Dimensions

CKQ^GDA50

- * Refer to "How to Order" on page 518 for positional relationship of the mounting surface and port.
- * The figures below indicate the CKQ^GDA50-□RAHZ.

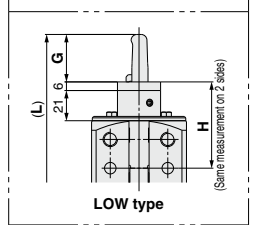
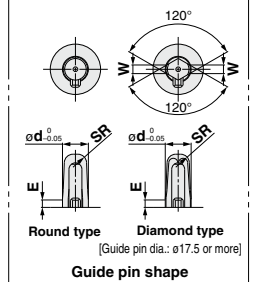
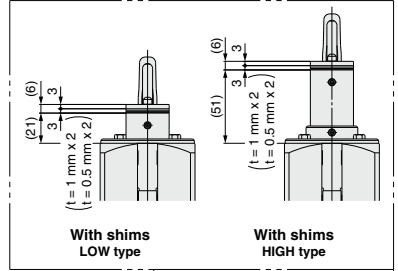
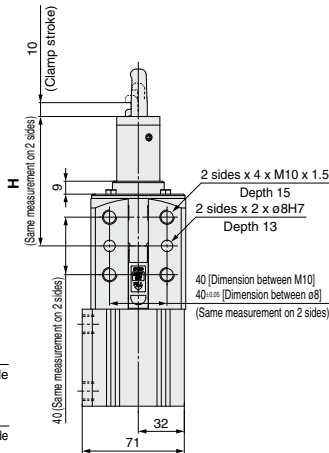
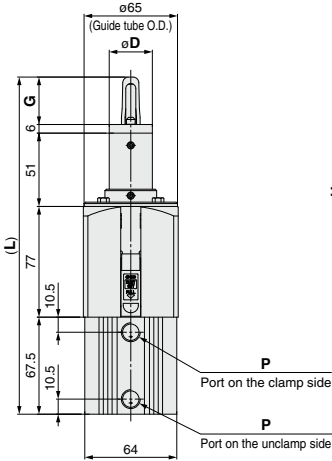
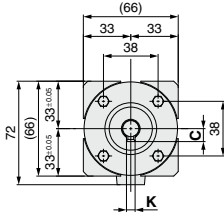

Bore diameter of workplace	C	øD	ød	E	G	H		K	L		SR	W	øZ
						LOW type	HIGH type		LOW type	HIGH type			
ø13	9	ø30	ø12.5 = 10	33	6	204.5	234.5	4	—	ø36	—	—	—
			ø12.7 = 9										
			ø12.8 = 8										
			ø12.9 = 8										
			ø13.0 = 7										
ø15	11	ø30	ø14.5 = 9	34	7	205.5	235.5	5	—	ø36	—	—	—
			ø14.7 = 8										
			ø14.8 = 8										
			ø14.9 = 7										
			ø15.0 = 7										
ø16	11	ø30	ø15.5 = 10	34	7	205.5	235.5	5.5	—	ø36	—	—	—
			ø15.7 = 9										
			ø15.8 = 8										
			ø15.9 = 8										
			ø16.0 = 7										

Bore diameter of workplace	C	øD	ød	E	G	H		K	L		SR	W	øZ
						LOW type	HIGH type		LOW type	HIGH type			
ø18	12	ø35	ø17.5 = 10	37	7	208.5	238.5	6	6	ø40	—	—	—
			ø17.7 = 9										
			ø17.8 = 8										
			ø17.9 = 8										
			ø18.0 = 7										
ø20	13	ø35	ø19.5 = 10	39	8	210.5	240.5	7	7	ø40	—	—	—
			ø19.7 = 9										
			ø19.8 = 8										
			ø19.9 = 8										
			ø20.0 = 7										
ø25	16	ø40	ø24.5 = 10	39	8	210.5	240.5	9.5	7	ø47	—	—	—
			ø24.7 = 9										
			ø24.8 = 8										
			ø24.9 = 8										
			ø25.0 = 7										
ø30	18	ø40	ø29.5 = 10	39	8	210.5	240.5	11	9	ø47	—	—	—
			ø29.7 = 9										
			ø29.8 = 8										
			ø29.9 = 8										
			ø30.0 = 7										

P		
NII	TN	TF
Rc1/4	NPT1/4	G1/4

CKQ_PD/CLKQ_PD Series

Dimensions

CLKQ_PDA50

* Refer to "How to Order" on page 518 for positional relationship of the mounting surface and port.

* The figures below indicate the CLKQGDA50-□RAHZ.

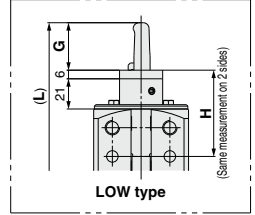
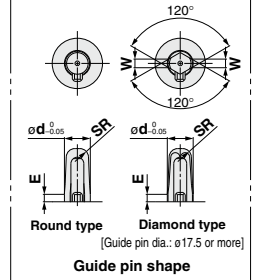
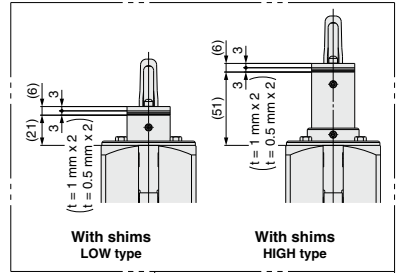
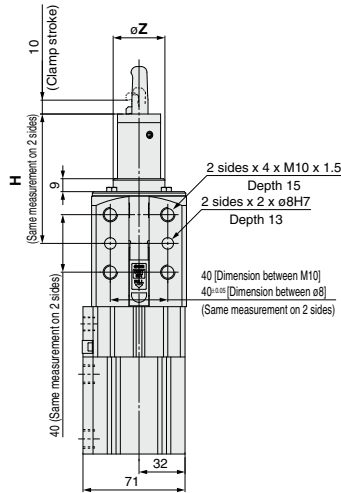
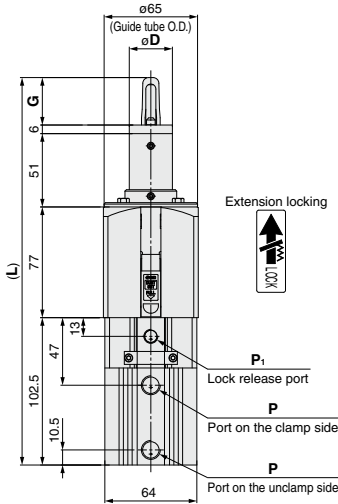
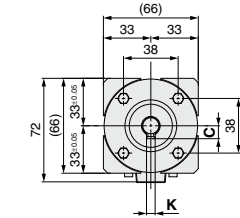

Rise direction of workpiece	C	øD	ød	E	G	H		K	L		SR	W	øZ
						LOW type	HIGH type		LOW type	HIGH type			
ø13	9	ø30	ø12.5 = 10	33	Without shims 60±0.05	Without shims 90±0.05	6	239.5	269.5	4	—	ø36	
			ø12.7 = 9										
			ø12.8 = 8										
			ø12.9 = 8										
			ø13.0 = 7										
ø15	11	ø30	ø14.5 = 9	34	Without shims 60±0.05	Without shims 90±0.05	7	240.5	270.5	5	—	ø36	
			ø14.7 = 8										
			ø14.8 = 8										
			ø14.9 = 7										
			ø15.0 = 7										
ø16	11	ø30	ø15.5 = 10	34	Without shims 60±0.05	Without shims 90±0.05	7	240.5	270.5	5.5	—	ø36	
			ø15.7 = 9										
			ø15.8 = 8										
			ø15.9 = 8										
			ø16.0 = 7										

Rise direction of workpiece	C	øD	ød	E	G	H		K	L		SR	W	øZ
						LOW type	HIGH type		LOW type	HIGH type			
ø18	12	ø35	ø17.5 = 10	37	Without shims 60±0.05	Without shims 90±0.05	7	243.5	273.5	6	6	ø40	
			ø17.7 = 9										
			ø17.8 = 8										
			ø17.9 = 8										
			ø18.0 = 7										
ø20	13	ø35	ø19.5 = 10	39	Without shims 60±0.05	Without shims 90±0.05	8	245.5	275.5	7	7	ø40	
			ø19.7 = 9										
			ø19.8 = 8										
			ø19.9 = 8										
			ø20.0 = 7										
ø25	16	ø40	ø24.5 = 10	39	Without shims 60±0.05	Without shims 90±0.05	8	245.5	275.5	9.5	7	ø47	
			ø24.7 = 9										
			ø24.8 = 8										
			ø24.9 = 8										
			ø25.0 = 7										
ø30	18	ø40	ø29.5 = 10	39	Without shims 60±0.05	Without shims 90±0.05	8	245.5	275.5	11	9	ø47	
			ø29.7 = 9										
			ø29.8 = 8										
			ø29.9 = 8										
			ø30.0 = 7										

P			P ₁		
Nll	TN	TF	Nll	TN	TF
Rc1/4	NPT1/4	G1/4	Rc1/8	NPT1/8	G1/8

Pin Clamp Cylinder **U series**

CKQ_P^GU/CLKQ_P^GU Series

How to Order

Built-in standard magnet C **KQGU A 50** - **177 R A L** **Z** - **P3DWASC**

Built-in strong magnet C **KQP U A 50** - **198 R A L** - **P79WSE**

With lock on the clamp side

Nil	Without lock
L	With lock

Number of auto switches

Nil	2 pcs.
S	1 pc. (Unclamp side)

* The D-P7 type is different-surface mounting. (Refer to page 536.)

Auto switch type

Nil	Without auto switch (Built-in magnet)
------------	---------------------------------------

* For applicable auto switch models, refer to page 525.
* Auto switches are included, (but not assembled).

Shim

Nil	Without shims
S	With 3 mm shims*

* When a model includes shims, two 1 mm shims and two 0.5 mm shims are attached.

Mounting surface (viewed from top)

Symbol	Port location
A	
B	

Bore size
50 50 mm

Port thread type

Nil	Rc
TN	NPT
TF	G

Guide pin diameter

* For guide pin diameter, refer to Table 1 below.

Guide pin shape

R	Round type
D	Diamond type*

* Diamond type guide pin diameter is ø17.5 or more.

Clamping height (Refer to the below figure.)

L	LOW type (40 mm)
H	HIGH type (70 mm)

LOW type **HIGH type**

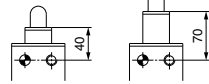

Clamping height

Body shape

Symbol	Dimension	Mounting hole (tap, pin hole) arrangement	Mounting	Mounting surface (viewed from top)
U	□66		Mounting tap: 2 x M10 x 1.5 Pin hole: 2 x øH7	

Clamp arm position (clockwise viewed from top)

Symbol	Position	Diagram
A	Same direction as port	
B	90° from port	
C	180° from port	
D	270° from port	

Table 1. Guide Pin Diameter

Symbol	125	127	128	129	130	145	147	148	149	150	155	157	158	159	160
Guide pin diameter	12.5	12.7	12.8	12.9	13.0	14.5	14.7	14.8	14.9	15.0	15.5	15.7	15.8	15.9	16.0
Applicable hole diameter of workpiece	For ø13					For ø15					For ø16				
Guide pin shape	Round type														

Symbol	175	177	178	179	180	195	197	198	199	200	245	247	248	249	250	295	297	298	299	300
Guide pin diameter	17.5	17.7	17.8	17.9	18.0	19.5	19.7	19.8	19.9	20.0	24.5	24.7	24.8	24.9	25.0	29.5	29.7	29.8	29.9	30.0
Applicable hole diameter of workpiece	For ø18					For ø20					For ø25					For ø30				
Guide pin shape	Round type, Diamond type																			

Table 2. Applicable Auto Switches/Refer to pages 1341 and 1435 for further information on auto switches.

Applicable cylinder series	Type	Auto switch model	Applicable magnetic field	Electrical entry	Indicator light	Wiring (Pin no in use)	Load voltage	Lead wire length	Applicable load
C(L)KQG series	Solid state auto switch	D-P3DWASC	AC magnetic field (Single-phase AC welding magnetic field)	Pre-wired connector	2-color indicator	2-wire (3-4)	24 VDC	0.3 m	Relay, PLC
		D-P3DWASE				2-wire (1-4)		0.5 m	
		D-P3DWA				2-wire		3 m	
		D-P3DWAL						5 m	
		D-P4DWSC		Pre-wired connector	2-wire (3-4)	0.3 m			
		D-P4DWSE			2-wire (1-4)	3 m			
		D-P4DWL			2-wire	5 m			
		D-P4DWZ							
C(L)KQP series	Reed auto switch	D-P79WSE	DC/AC magnetic field	Pre-wired connector	2-color indicator	2-wire (1-4)	24 VDC	0.3 m	
		D-P74L		Grommet	1-color indicator	2-wire	24 VDC 100 VAC	3 m	
		D-P74Z						5 m	

Refer to pages 536 and 537 for cylinders with auto switches.

- Auto switch proper mounting position, mounting height and operating distance
- Operating range
- Auto switch mounting

Basic Specifications

Action	Double acting	
Bore size	50 mm	
Fluid	Air	
Minimum operating pressure	CKQ□: 0.1 MPa	CLKQ□ (With lock): 0.15 MPa*
Maximum operating pressure	Guide pin diameter	0.7 MPa
	ø12.5 to ø13.0	1.0 MPa
	ø14.5 to ø30.0	1.0 MPa
Proof pressure	Guide pin diameter	1.0 MPa
	ø12.5 to ø13.0	1.5 MPa
	ø14.5 to ø30.0	1.5 MPa
Ambient and fluid temperature	-10 to 60°C (No freezing)	
Cushion	None	
Lubrication	Non-lube	
Piston speed (Clamp speed)	50 to 150 mm/sec	
Port size (Cylinder port)	1/4 (Rc, NPT, G)	

* Minimum operating pressure is 0.2 MPa when cylinder part and locking part use the same piping.

Lock Specifications

Locking action	Spring locking (Exhaust locking)
Unlocking pressure	0.2 MPa or more
Lock starting pressure	0.05 MPa or less
Locking direction	Lock at extended direction (Clamp holding)
Port size (Lock release port)	1/8 (Rc, NPT, G)
Holding force (Maximum static load)	982 N

Clamping Force

Model	Guide pin diameter	Operating pressure [MPa]								
		0.2	0.3	0.4	0.5	0.6	0.7	0.8	0.9	1.0
C(L)KQ [®] □	ø12.5 to ø13.0	164.9	329.8	494.7	659.6	824.5	989.4	—	—	—
	ø14.5 to ø30.0	164.9	329.8	494.7	659.6	824.5	989.4	Note 1) 1154.3	Note 1) 1319.2	Note 1) 1484.1

Note 1) Lock holding force of the CLKQ□ is 982 N. Design the circuit such that the lock holding force is taken into consideration when the operating pressure exceeds 0.75 MPa.

The operating pressure should be not greater than the lock holding force as it may cause wearing out and/or damage of the locking part and shorten lock life and may lead to possible failure if applied with a load larger than the lock holding force.

Note 2) It takes approximately 0.3 seconds for the cylinder to operate to generate clamping force from an unclamping state (when no speed controller is installed). Design circuit taking into consideration the time before the clamping force is generated.

Note 3) Determine the clamping force according to the strength of the workpiece. It can be damaged if the clamping force is too large.

Weight

Model	C(L)KQ [®] U				
	Guide pin diameter [mm]	Without lock		With lock	
		LOW	HIGH	LOW	HIGH
ø12.5 to ø13.0	1.63	1.8	2.15	2.32	
ø14.5 to ø15.0	1.63	1.8	2.15	2.32	
ø15.5 to ø16.0	1.64	1.81	2.15	2.32	
ø17.5 to ø18.0	1.68	1.86	2.2	2.37	
ø19.5 to ø20.0	1.69	1.87	2.2	2.38	
ø24.5 to ø25.0	1.75	1.96	2.26	2.47	
ø29.5 to ø30.0	1.79	2	2.31	2.51	

Replacement Parts

The guide pin and clamp arm are the same as those of the D series. For details, refer to page 520.

CKQ_PU/CLKQ_PU Series

Dimensions

CKQ_PUA50

* Refer to "How to Order" on page 524 for positional relationship of the mounting surface and port.

* The figures below indicate the CKQGUA50-□RAHZ.

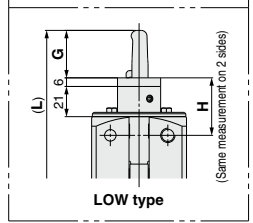
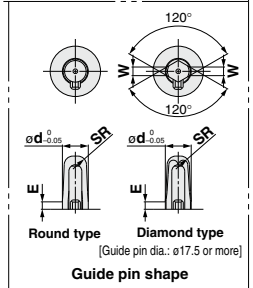
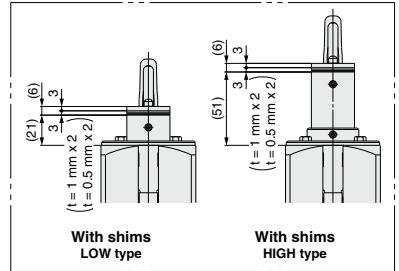
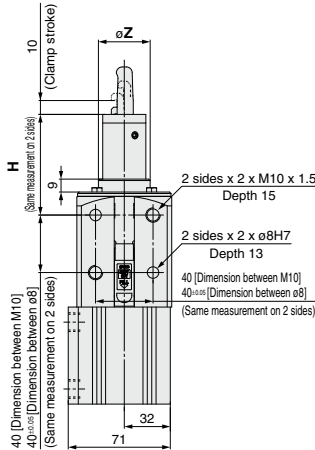
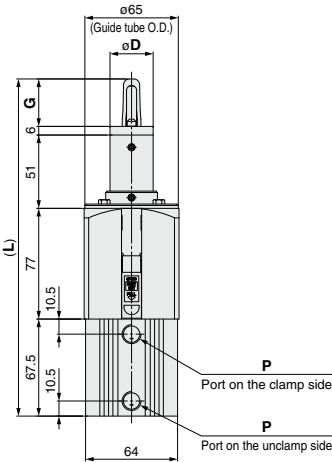
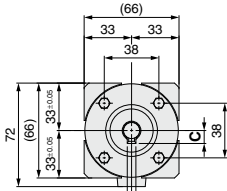

Hole diameter of workplace	C	øD	ød	E	G	H		K	L		SR	W	øZ
						LOW type	HIGH type		LOW type	HIGH type			
ø13	9	ø30	33	ø12.5 = 10	33	Without shims	Without shims	6	204.5	234.5	4	—	ø36
				ø12.7 = 9		Without shims	Without shims						
				ø12.8 = 8		With shims	With shims						
				ø12.9 = 8		With shims	With shims						
				ø13.0 = 7		With shims	With shims						
ø15	11	ø30	34	ø14.5 = 9	34	Without shims	Without shims	7	205.5	235.5	5	—	ø36
				ø14.7 = 8		Without shims	Without shims						
				ø14.8 = 8		With shims	With shims						
				ø14.9 = 7		With shims	With shims						
				ø15.0 = 7		With shims	With shims						
ø16	11	ø30	34	ø15.5 = 10	34	Without shims	Without shims	7	205.5	235.5	5.5	—	ø36
				ø15.7 = 9		Without shims	Without shims						
				ø15.8 = 8		With shims	With shims						
				ø15.9 = 8		With shims	With shims						
				ø16.0 = 7		With shims	With shims						

P		
NII	TN	TF
Rc1/4	NPT1/4	G1/4

Hole diameter of workplace	C	øD	ød	E	G	H		K	L		SR	W	øZ
						LOW type	HIGH type		LOW type	HIGH type			
ø18	12	ø35	37	ø17.5 = 10	37	Without shims	Without shims	7	208.5	238.5	6	6	ø40
				ø17.7 = 9		Without shims	Without shims						
				ø17.8 = 8		With shims	With shims						
				ø17.9 = 8		With shims	With shims						
				ø18.0 = 7		With shims	With shims						
ø20	13	ø35	39	ø19.5 = 10	39	Without shims	Without shims	8	210.5	240.5	7	7	ø40
				ø19.7 = 9		Without shims	Without shims						
				ø19.8 = 8		With shims	With shims						
				ø19.9 = 8		With shims	With shims						
				ø20.0 = 7		With shims	With shims						
ø25	16	ø40	39	ø24.5 = 10	39	Without shims	Without shims	8	210.5	240.5	9.5	7	ø47
				ø24.7 = 9		Without shims	Without shims						
				ø24.8 = 8		With shims	With shims						
				ø24.9 = 8		With shims	With shims						
				ø25.0 = 7		With shims	With shims						
ø30	18	ø40	39	ø29.5 = 10	39	Without shims	Without shims	8	210.5	240.5	11	9	ø47
				ø29.7 = 9		Without shims	Without shims						
				ø29.8 = 8		With shims	With shims						
				ø29.9 = 8		With shims	With shims						
				ø30.0 = 7		With shims	With shims						

Dimensions

CLKQ^GUA50

- * Refer to "How to Order" on page 524 for positional relationship of the mounting surface and port.
- * The figures below indicate the CLKQ^GUA50-□RAHZ.

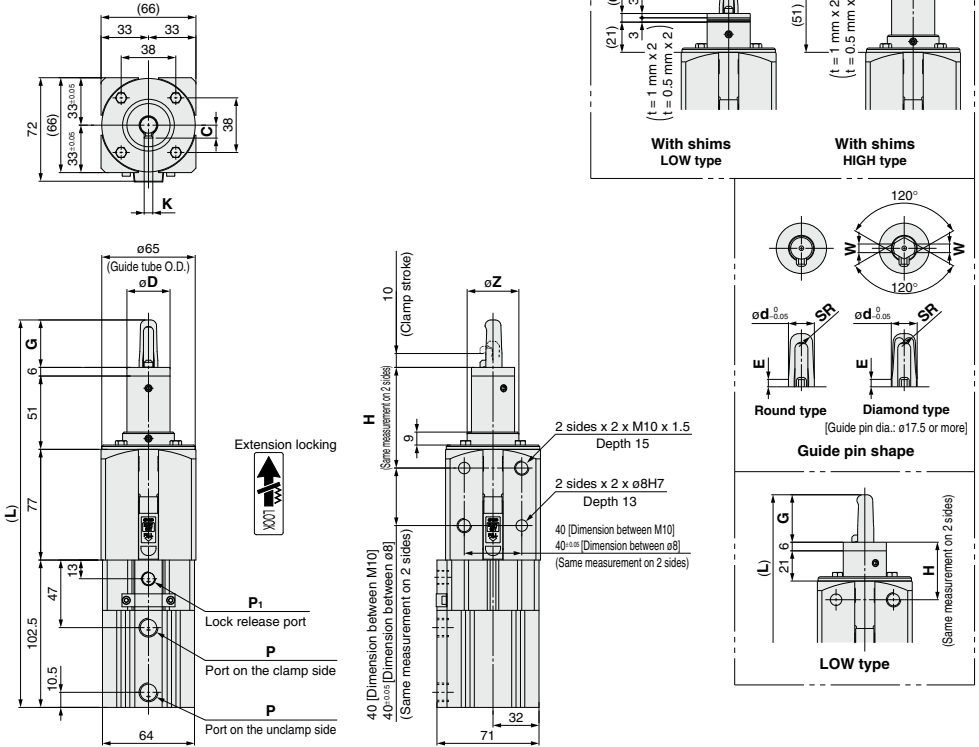

Bore diameter of workpiece	C	øD	ød	E	G	H		K	L		SR	W	øZ
						LOW type	HIGH type		LOW type	HIGH type			
ø13	9	ø30	ø12.5 = 10	33	Without shims	Without shims	6	239.5	269.5	4	—	ø36	
			ø12.7 = 9										
			ø12.8 = 8										
			ø12.9 = 8										
			ø13.0 = 7										
ø15	11	ø30	ø14.5 = 9	34	Without shims	Without shims	7	240.5	270.5	5	—	ø36	
			ø14.7 = 8										
			ø14.8 = 8										
			ø14.9 = 7										
			ø15.0 = 7										
ø16	11	ø30	ø15.5 = 10	34	Without shims	Without shims	7	240.5	270.5	5.5	—	ø36	
			ø15.7 = 9										
			ø15.8 = 8										
			ø15.9 = 8										
			ø16.0 = 7										

Bore diameter of workpiece	C	øD	ød	E	G	H		K	L		SR	W	øZ
						LOW type	HIGH type		LOW type	HIGH type			
ø18	12	ø35	ø17.5 = 10	37	Without shims	Without shims	7	243.5	273.5	6	6	ø40	
			ø17.7 = 9										
			ø17.8 = 8										
			ø17.9 = 8										
			ø18.0 = 7										
ø20	13	ø35	ø19.5 = 10	39	Without shims	Without shims	8	245.5	275.5	7	7	ø40	
			ø19.7 = 9										
			ø19.8 = 8										
			ø19.9 = 8										
			ø20.0 = 7										
ø25	16	ø40	ø24.5 = 10	39	Without shims	Without shims	8	245.5	275.5	9.5	7	ø47	
			ø24.7 = 9										
			ø24.8 = 8										
			ø24.9 = 8										
			ø25.0 = 7										
ø30	18	ø40	ø29.5 = 10	39	Without shims	Without shims	8	245.5	275.5	11	9	ø47	
			ø29.7 = 9										
			ø29.8 = 8										
			ø29.9 = 8										
			ø30.0 = 7										

P			P ₁		
NII	TN	TF	NII	TN	TF
Rc1/4	NPT1/4	G1/4	Rc1/8	NPT1/8	G1/8

Pin Clamp Cylinder **K series**

CKQ_P^GK/CLKQ_P^GK Series

How to Order

Built-in standard magnet C □ KQGK C 50 - 177 R A L □ Z - P3DWASC □

Built-in strong magnet C □ KQP K C 50 - 198 R A L □ - P79WSE □

With lock on the clamp side

Nil	Without lock
L	With lock

Mounting surface (viewed from top)

Symbol	Port location	Symbol	Port location
C	Mounting surface with the taps diagonal (top right and bottom left) Port	E	Mounting surface with the taps diagonal (top left and bottom right) Port
D	Mounting surface with the taps diagonal (top left and bottom right) Port	F	Mounting surface with the taps diagonal (top right and bottom left) Port

Bore size

50	50 mm
----	-------

Port thread type

Nil	Rc
TN	NPT
TF	G

Guide pin diameter
* For guide pin diameter, refer to Table 1 below.

Guide pin shape

R	Round type	
D	Diamond type*	

* Diamond type guide pin diameter is ø17.5 or more.

Body shape

Symbol	Dimension	Mounting hole (tap, pin hole) arrangement	Mounting	Mounting surface (viewed from top)
K	□66		Mounting tap: 2 x M10 x 1.5 Pin hole: 2 x ø10H7	 Mounting surface (Two facing sides)

Table 1. Guide Pin Diameter

Symbol	125	127	128	129	130	145	147	148	149	150	155	157	158	159	160
Guide pin diameter	12.5	12.7	12.8	12.9	13.0	14.5	14.7	14.8	14.9	15.0	15.5	15.7	15.8	15.9	16.0
Applicable hole diameter of workpiece	For ø13					For ø15					For ø16				
Guide pin shape	Round type														

Symbol	175	177	178	179	180	195	197	198	199	200	245	247	248	249	250	295	297	298	299	300
Guide pin diameter	17.5	17.7	17.8	17.9	18.0	19.5	19.7	19.8	19.9	20.0	24.5	24.7	24.8	24.9	25.0	29.5	29.7	29.8	29.9	30.0
Applicable hole diameter of workpiece	For ø18					For ø20					For ø25					For ø30				
Guide pin shape	Round type, Diamond type																			

Number of auto switches

Nil	2 pcs.
S	1 pc. (Unclamp side)

* The D-P7 type is different-surface mounting. (Refer to page 536.)

Auto switch type

Nil	Without auto switch (Built-in magnet)
-----	---------------------------------------

* For applicable auto switch models, refer to page 529.
* Auto switches are included, (but not assembled).

Shim

Nil	Without shims
S	With 3 mm shims*

* When a model includes shims, two 1 mm shims and two 0.5 mm shims are attached.

Clamping height (Refer to the below figure.)

L	LOW type (40 mm)
H	HIGH type (70 mm)

LOW type HIGH type

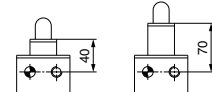

Clamping height

Clamp arm position (clockwise viewed from top)

Symbol	Port location	Guide pin location
A	Same direction as port	180° from port
B	90° from port	270° from port
C	180° from port	Same direction as port
D	270° from port	90° from port

Table 2. Applicable Auto Switches/Refer to pages 1341 to 1435 for further information on auto switches.

Applicable cylinder series	Type	Auto switch model	Applicable magnetic field	Electrical entry	Indicator light	Wiring (Pin no in use)	Load voltage	Lead wire length	Applicable load
C(L)KQG series	Solid state auto switch	D-P3DWASC	AC magnetic field (Single-phase AC welding magnetic field)	Pre-wired connector	2-color indicator	2-wire (3-4)	24 VDC	0.3 m	Relay, PLC
		D-P3DWASE				2-wire (1-4)		0.5 m	
		D-P3DWA				2-wire		3 m	
		D-P3DWAL						5 m	
		D-P4DWSC		Pre-wired connector	2-wire (3-4)	0.3 m			
		D-P4DWSE			2-wire (1-4)	3 m			
		D-P4DWL			2-wire	5 m			
		D-P4DWZ							
C(L)KQP series	Reed auto switch	D-P79WSE	DC/AC magnetic field	Pre-wired connector	2-color indicator	2-wire (1-4)	24 VDC	0.3 m	
		D-P74L		Grommet	1-color indicator	2-wire	24 VDC 100 VAC	3 m	
		D-P74Z						5 m	

Refer to pages 536 and 537 for cylinders with auto switches.

- Auto switch proper mounting position, mounting height and operating distance
- Operating range
- Auto switch mounting

Basic Specifications

Action	Double acting	
Bore size	50 mm	
Fluid	Air	
Minimum operating pressure	CKQ□: 0.1 MPa	CLKQ□ (With lock): 0.15 MPa*
Maximum operating pressure	Guide pin diameter	0.7 MPa
	ø12.5 to ø13.0	1.0 MPa
	ø14.5 to ø30.0	1.0 MPa
Proof pressure	Guide pin diameter	1.0 MPa
	ø12.5 to ø13.0	1.5 MPa
	ø14.5 to ø30.0	1.5 MPa
Ambient and fluid temperature	-10 to 60°C (No freezing)	
Cushion	None	
Lubrication	Non-lube	
Piston speed (Clamp speed)	50 to 150 mm/sec	
Port size (Cylinder port)	1/4 (Rc, NPT, G)	

* Minimum operating pressure is 0.2 MPa when cylinder part and locking part use the same piping.

Lock Specifications

Locking action	Spring locking (Exhaust locking)
Unlocking pressure	0.2 MPa or more
Lock starting pressure	0.05 MPa or less
Locking direction	Lock at extended direction (Clamp holding)
Port size (Lock release port)	1/8 (Rc, NPT, G)
Holding force (Maximum static load)	982 N

Clamping Force

Model	Guide pin diameter	Operating pressure [MPa]								
		0.2	0.3	0.4	0.5	0.6	0.7	0.8	0.9	1.0
C(L)KQ _P □	ø12.5 to ø13.0	164.9	329.8	494.7	659.6	824.5	989.4	—	—	—
	ø14.5 to ø30.0	164.9	329.8	494.7	659.6	824.5	989.4	Note 1) 1154.3	Note 1) 1319.2	Note 1) 1484.1

Note 1) Lock holding force of the CLKQ□ is 982 N. Design the circuit such that the lock holding force is taken into consideration when the operating pressure exceeds 0.75 MPa.

The operating pressure should be not greater than the lock holding force as it may cause wearing out and/or damage of the locking part and shorten lock life and may lead to possible failure if applied with a load larger than the lock holding force.

Note 2) It takes approximately 0.3 seconds for the cylinder to operate to generate clamping force from an unclamping state (when no speed controller is installed). Design circuit taking into consideration the time before the clamping force is generated.

Note 3) Determine the clamping force according to the strength of the workpiece. It can be damaged if the clamping force is too large.

Weight

Model	C(L)KQ _P K [kg]				
	Guide pin diameter [mm]	Without lock		With lock	
		LOW	HIGH	LOW	HIGH
ø12.5 to ø13.0	1.63	1.8	2.15	2.32	
ø14.5 to ø15.0	1.63	1.8	2.15	2.32	
ø15.5 to ø16.0	1.64	1.81	2.15	2.32	
ø17.5 to ø18.0	1.68	1.86	2.2	2.37	
ø19.5 to ø20.0	1.69	1.87	2.2	2.38	
ø24.5 to ø25.0	1.75	1.96	2.26	2.47	
ø29.5 to ø30.0	1.79	2	2.31	2.51	

Replacement Parts

The guide pin and clamp arm are the same as those of the D series. For details, refer to page 520.

Pin Clamp Cylinder **M series**

CKQ_P^GM/CLKQ_P^GM Series

How to Order

Built-in standard magnet C □ KQGM C 50 □ - 177 R A L □ Z - P3DWASC □

Built-in strong magnet C □ KQP M C 50 □ - 198 R A L □ - P79WSE □

With lock on the clamp side

Nil	Without lock
L	With lock

Mounting surface (viewed from top)

Symbol	Port location	Symbol	Port location
C	Mounting surface with the taps diagonal (top right and bottom left) Port	E	Mounting surface with the taps diagonal (top left and bottom right) Port
D	Mounting surface with the taps diagonal (top left and bottom right) Port	F	Mounting surface with the taps diagonal (top right and bottom left) Port

Bore size

50	50 mm
----	-------

Port thread type

Nil	Rc
TN	NPT
TF	G

Guide pin diameter
* For guide pin diameter, refer to Table 1 below.

Guide pin shape

R	Round type	
D	Diamond type*	

* Diamond type guide pin diameter is $\phi 17.5$ or more.

Body shape

Symbol	Dimension	Mounting hole (tap, pin hole) arrangement	Mounting	Mounting surface (viewed from top)
M	□66		Mounting tap: 2 x M12 x 1.75 Pin hole: 2 x $\phi 10H7$	

Number of auto switches

Nil	2 pcs.
S	1 pc. (Unclamp side)

* The D-P7 type is different-surface mounting. (Refer to page 536.)

Auto switch type

Nil	Without auto switch (Built-in magnet)
-----	---------------------------------------

* For applicable auto switch models, refer to page 533.
* Auto switches are included, (but not assembled).

Shim

Nil	Without shims
S	With 3 mm shims*

* When a model includes shims, two 1 mm shims and two 0.5 mm shims are attached.

Clamping height (Refer to the below figure.)

L	LOW type (40 mm)
H	HIGH type (70 mm)

LOW type HIGH type

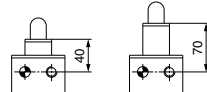

Clamping height

Clamp arm position (clockwise viewed from top)

Symbol	Position	Symbol	Position
A	Same direction as port Port Clamp arm Guide pin.	C	180° from port Port Clamp arm Guide pin.
B	90° from port Port Clamp arm Guide pin.	D	270° from port Port Clamp arm Guide pin.

Table 1. Guide Pin Diameter

Symbol	125	127	128	129	130	145	147	148	149	150	155	157	158	159	160
Guide pin diameter	12.5	12.7	12.8	12.9	13.0	14.5	14.7	14.8	14.9	15.0	15.5	15.7	15.8	15.9	16.0
Applicable hole diameter of workpiece	For $\phi 13$					For $\phi 15$					For $\phi 16$				
Guide pin shape	Round type														

Symbol	175	177	178	179	180	195	197	198	199	200	245	247	248	249	250	295	297	298	299	300
Guide pin diameter	17.5	17.7	17.8	17.9	18.0	19.5	19.7	19.8	19.9	20.0	24.5	24.7	24.8	24.9	25.0	29.5	29.7	29.8	29.9	30.0
Applicable hole diameter of workpiece	For $\phi 18$					For $\phi 20$					For $\phi 25$					For $\phi 30$				
Guide pin shape	Round type, Diamond type																			

Table 2. Applicable Auto Switches/Refer to pages 1341 to 1435 for further information on auto switches.

Applicable cylinder series	Type	Auto switch model	Applicable magnetic field	Electrical entry	Indicator light	Wiring (Pin no in use)	Load voltage	Lead wire length	Applicable load
C(L)KQG series	Solid state auto switch	D-P3DWASC	AC magnetic field (Single-phase AC welding magnetic field)	Pre-wired connector	2-color indicator	2-wire (3-4)	24 VDC	0.3 m	Relay, PLC
		D-P3DWASE				2-wire (1-4)		0.5 m	
		D-P3DWA				2-wire		3 m	
		D-P3DWAL						5 m	
		D-P3DWAZ		Pre-wired connector	2-wire (3-4)	0.3 m			
		D-P4DWSC			2-wire (1-4)	3 m			
		D-P4DWSE			2-wire	5 m			
		D-P4DWL							
D-P4DWZ									
C(L)KQP series	Reed auto switch	D-P79WSE	DC/AC magnetic field	Pre-wired connector	2-color indicator	2-wire (1-4)	24 VDC	0.3 m	
		D-P74L		Grommet	1-color indicator	2-wire	24 VDC 100 VAC	3 m	
		D-P74Z						5 m	

Refer to pages 536 and 537 for cylinders with auto switches.

- Auto switch proper mounting position, mounting height and operating distance
- Operating range
- Auto switch mounting

Basic Specifications

Action	Double acting	
Bore size	50 mm	
Fluid	Air	
Minimum operating pressure	CKQ□: 0.1 MPa	CLKQ□ (With lock): 0.15 MPa*
Maximum operating pressure	Guide pin diameter	0.7 MPa
	ø12.5 to ø13.0	1.0 MPa
	ø14.5 to ø30.0	1.0 MPa
Proof pressure	Guide pin diameter	1.0 MPa
	ø12.5 to ø13.0	1.5 MPa
	ø14.5 to ø30.0	1.5 MPa
Ambient and fluid temperature	-10 to 60°C (No freezing)	
Cushion	None	
Lubrication	Non-lube	
Piston speed (Clamp speed)	50 to 150 mm/sec	
Port size (Cylinder port)	1/4 (Rc, NPT, G)	

* Minimum operating pressure is 0.2 MPa when cylinder part and locking part use the same piping.

Lock Specifications

Locking action	Spring locking (Exhaust locking)
Unlocking pressure	0.2 MPa or more
Lock starting pressure	0.05 MPa or less
Locking direction	Lock at extended direction (Clamp holding)
Port size (Lock release port)	1/8 (Rc, NPT, G)
Holding force (Maximum static load)	982 N

Clamping Force

Model	Guide pin diameter	Operating pressure [MPa]								
		0.2	0.3	0.4	0.5	0.6	0.7	0.8	0.9	1.0
C(L)KQP□	ø12.5 to ø13.0	164.9	329.8	494.7	659.6	824.5	989.4	—	—	—
	ø14.5 to ø30.0	164.9	329.8	494.7	659.6	824.5	989.4	Note 1) 1154.3	Note 1) 1319.2	Note 1) 1484.1

Note 1) Lock holding force of the CLKQ□ is 982 N. Design the circuit such that the lock holding force is taken into consideration when the operating pressure exceeds 0.75 MPa.

The operating pressure should be not greater than the lock holding force as it may cause wearing out and/or damage of the locking part and shorten lock life and may lead to possible failure if applied with a load larger than the lock holding force.

Note 2) It takes approximately 0.3 seconds for the cylinder to operate to generate clamping force from an unclamping state (when no speed controller is installed). Design circuit taking into consideration the time before the clamping force is generated.

Note 3) Determine the clamping force according to the strength of the workpiece. It can be damaged if the clamping force is too large.

Weight

Model	C(L)KQP□M				
	Guide pin diameter [mm]	Without lock		With lock	
		LOW	HIGH	LOW	HIGH
ø12.5 to ø13.0	1.63	1.8	2.14	2.31	
ø14.5 to ø15.0	1.63	1.8	2.14	2.31	
ø15.5 to ø16.0	1.63	1.8	2.15	2.32	
ø17.5 to ø18.0	1.68	1.85	2.19	2.37	
ø19.5 to ø20.0	1.68	1.86	2.2	2.38	
ø24.5 to ø25.0	1.74	1.95	2.26	2.47	
ø29.5 to ø30.0	1.79	1.99	2.3	2.51	

Replacement Parts

The guide pin and clamp arm are the same as those of the D series. For details, refer to page 520.

CKQG^G□/CLKQG^G□ Series Auto Switch Mounting

Auto Switch Proper Mounting Position, Mounting Height and Operating Distance

Auto Switch Proper Mounting Position

Mounting	Round groove mounting				Rail mounting	
	D-P3DWA□		D-P4DW□		D-P74□ D-P79WSE	
	A	B	A	B	A	B
CKQG	9.5	22.5	7	17 or more	—	—
CLKQG	44.5	54.5	42	52 or more	—	—
CKQP	—	—	—	—	5.5	20.5 or more
CLKQP	—	—	—	—	40.5	55.5 or more

Note) Adjust the auto switch after confirming the operating conditions in the actual setting.

Auto Switch Proper Mounting Height

Mounting	Round groove mounting		Rail mounting
	D-P3DWA□	D-P4DW□	D-P74□ D-P79WSE
	= U		
C(L)KQG	45	50	—
C(L)KQP	—	—	50

D-P3DWA□ [CKQG]

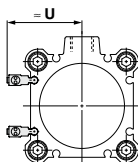
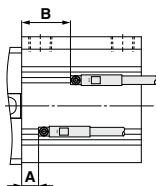

[CLKQG]

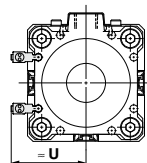
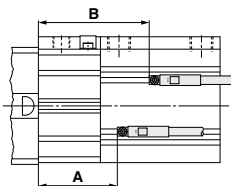

D-P4DW□ [CKQG]

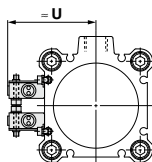
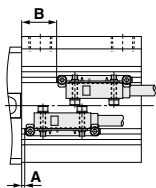

[CLKQG]

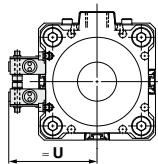
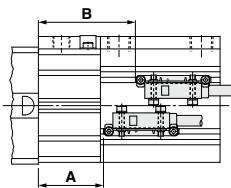

D-P74□ D-P79WSE [CKQP]

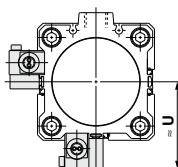
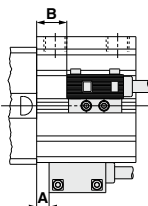

[CLKQP]

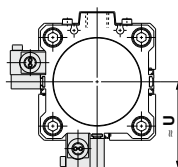
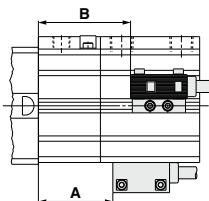

Operating Range

Cylinder model	Auto switch model	Operating range
C(L)KQG	D-P3DWA□	7
	D-P4DW□	6.5
C(L)KQP	D-P74□ D-P79WSE	10

* Values which include hysteresis are for guideline purposes only, they are not a guarantee (assuming approximately ±30% dispersion) and may change substantially depending on the ambient environment.

Auto Switch Mounting

For D-P3DWA□ (Fig. 1)

1. Insert the auto switch into the mating groove of the cylinder tube.
2. Check the detecting position of the auto switch and fix the auto switch firmly with the hexagon socket head cap screw (M2.5 x 12 L).
3. If the detecting position is changed, go back to step 1.

Note 1) Ensure that the auto switch is covered with the mating groove to protect the auto switch.

Note 2) The tightening torque for the hexagon socket head cap screw (M2.5 x 12 L) is 0.2 to 0.3 N-m.

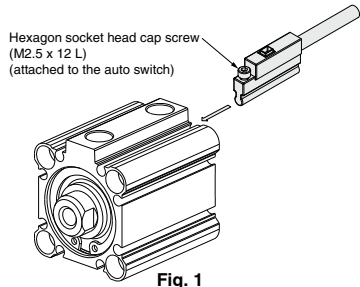

Fig. 1

For D-P4DW□ (Fig. 2)

1. Mount the auto switch mounting bracket onto the auto switch mounting nut by tightening the bracket mounting screws (M2.5) lightly.
2. Insert the auto switch mounting nut into the switch groove.
3. Fix the auto switch and the auto switch mounting bracket temporarily with the auto switch mounting screw (M3).
4. Check the detecting position of the auto switch and fix the auto switch firmly with the auto switch mounting screws and bracket mounting screws. (The tightening torque is 0.25 to 0.35 N-m for M2.5 and 0.5 to 0.6 N-m for M3.)

Auto switch mounting bracket part number	Contents/Quantity
BQ7-050	<ul style="list-style-type: none"> · Auto switch mounting bracket x 1 · Auto switch mounting nut x 1 · Hexagon socket head cap screw x 2 · Hexagon socket head cap screw x 2 (With spring washer) · Spring washer x 2

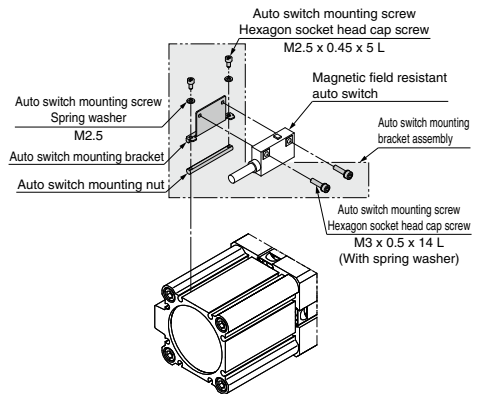

Fig. 2

For D-P74□ and P79WSE (Fig. 3)

1. Mount the auto switch mounting bracket onto the auto switch mounting nut by tightening the bracket mounting screws lightly through the hole on the top of bracket.
2. Insert the nut section of the auto switch mounting bracket assembly (bracket + nut) into the groove of the rail and set it at the auto switch mounting position.
3. Insert the auto switch mounting screws into the through hole of the auto switch, and fix the auto switch mounting bracket and auto switch temporarily.
4. Check the detecting position of the auto switch and fix the auto switch firmly with the auto switch mounting screws and bracket mounting screws. (The tightening torque is 0.5 to 0.7 N-m.)

* Be careful of the mounting direction of the D-P79WSE when installed to the auto switch mounting bracket. Be sure the soft-resin mold surface faces the auto switch mounting bracket side when mounting.

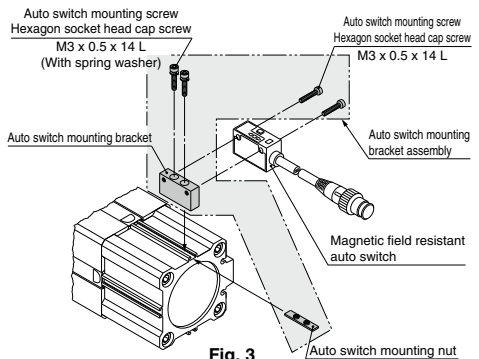

Fig. 3

Auto switch mounting bracket part number	Contents/Quantity
BQP1T-050	<ul style="list-style-type: none"> · Auto switch mounting bracket x 1 · Auto switch mounting nut x 1 · Hexagon socket head cap screw x 2 · Hexagon socket head cap screw x 2 (With spring washer)



CKQ^G_P□/CLKQ^G_P□ Series

Specific Product Precautions 1

Be sure to read this before handling the products. Refer to page 9 for safety instructions and pages 10 to 19 for actuator and auto switch precautions.

Design

⚠ Warning

- 1. There is a possibility of dangerous sudden action by cylinders if sliding parts of machinery are twisted due to external forces, etc.**

In such cases, human injury may occur; e.g., by catching hands or feet in the machinery, or damage to the machinery itself may occur. Therefore, the machine should be adjusted to operate smoothly and designed to avoid such dangers.

- 2. A protective cover is recommended to minimize the risk of personal injury.**

If a stationary object and moving parts of a cylinder are in close proximity, personal injury may occur. Design the structure to avoid contact with the human body.

- 3. Securely tighten all stationary parts and connected parts so that they will not become loose.**

Especially when a cylinder operates with high frequency or is installed where there is a lot of vibration, ensure that all parts remain secure.

- 4. Design the equipment so that the maximum theoretical force is not applied to the cylinder.**

If the cylinder becomes damaged there is a danger of human injury and or equipment damage.

- 5. Select the mounting base by taking into consideration its rigidity because the cylinder applies a large amount of force.**

Otherwise there is a danger of human injury and or equipment damage.

- 6. Consider the possibility of a decrease in circuit pressure when power is turned off.**

If the cylinder is used for a clamping application there is a danger of the workpiece being released since the circuit pressure decreases when the power is turned off. Install safety equipment to prevent human injury and damage to machine and or equipment. The same consideration should be given for hanging or lift applications to prevent dropping of a workpiece.

- 7. Consider a possible loss of power source.**

Measures should be taken to protect against bodily injury and equipment damage in the event that there is a loss of power to equipment controlled by pneumatics, electricity, or hydraulics.

- 8. Consider emergency stops.**

Design so that human injury and/or damage to machinery and equipment will not be caused when machinery is stopped by a safety device under abnormal conditions, a power outage or a manual emergency stop.

- 9. Consider the action when operation is restarted after an emergency stop or abnormal stop.**

Design the machinery so that human injury or equipment damage will not occur upon restart of operation.

When the cylinder has to be reset at the starting position, install manual safety equipment.

- 10. Intermediate stop**

In the case of 3-position closed center of a valve, it is difficult to make a piston stop at the required position as accurately and precisely as with hydraulic pressure due to compressibility of air. Furthermore, since valves and cylinders, etc. are not guaranteed for zero air leakage, it may not be possible to hold a stopped position for an extended period of time. Contact SMC in the case it is necessary to hold a stopped position for an extended period. Do not intermediately stop the CLKQ cylinder during a locking operation because it will shorten the life of the cylinder.

Selection

⚠ Warning

- 1. Confirm the specifications.**

The products featured in this catalog are designed for use in industrial compressed air systems. If the products are used in conditions where pressure and/or temperature are outside the range of specifications, damage and/or malfunctions may occur. Do not use in these conditions. (Refer to the specifications.)

Consult SMC if you use a fluid other than compressed air.

- 2. Do not use for applications other than clamping.**

Since the cylinder performs both positioning and clamping simultaneously, any other application may cause an accident or damage to the cylinder.

- 3. Do not modify the cylinder.**

Do not modify the cylinder because it may cause damage to it, shorten the protect life, and or cause an accident.

- 4. The following table shows the maximum thickness of workpieces that be clamped.**

Model	Without shims	With shims
CKQG	10 mm	10 to 13 mm
CLKQG	10 mm	10 to 13 mm
CKQP	10 mm	10 to 13 mm
CLKQP	10 mm	10 to 13 mm

Workpieces to be clamped should not be thicker than those shown in the table.

- 5. Clamp only the flat side of a workpiece.**

- 6. If a workpiece is transferred three dimensionally and at high speed by a robot after it is clamped, the work weight must be 1/10 or less of the theoretical thrust (clamping force), or stoppers should be installed as a preventive measure for the movement of the workpiece.**

- 7. Do not clamp without setting the workpiece on a work surface.**

If the clamp arm makes contact with the seat surface without clamping a workpiece, the surface flatness condition of the seat surface and the clamp arm (the clamping surface) will be adversely effected.

- 8. Do not apply an impact load, strong vibrations or rotating force to the product.**

Since the cylinder is composed of precisely manufactured parts, they may be damaged and the life may be shortened if a strong impact load, strong vibration or rotating force are applied.



CKQ^G_P□/CLKQ^G_P□ Series

Specific Product Precautions 2

Be sure to read this before handling the products. Refer to page 9 for safety instructions and pages 10 to 19 for actuator and auto switch precautions.

Selection

Warning

[For the CLKQG/P series only]

9. Do not use for intermediate cylinder stops.

This cylinder is designed to lock in a clamped condition to prevent unwanted movement. Do not perform any intermediate stops while the cylinder is operating, since it will shorten the product life.

10. Select the correct locking position since this cylinder does not generate a holding force opposite to the locking direction.

The forwarded lock type (F type) clamp does not generate a holding force in the opposite direction (clamping direction). In addition the locking direction can not be changed.

11. Even when locked, there may be a stroke movement of approximately 1 mm in the locking direction due to external forces, such as the weight of the workpiece.

Even when locked, if air pressure drops, a stroke movement of approximately 1 mm may occur in the locking direction. This is caused by external forces, such as, the workpiece weight due to the general characteristics of the locking mechanism.



CKQG_P□/CLKQG_P□ Series

Specific Product Precautions 3

Be sure to read this before handling the products. Refer to page 9 for safety instructions and pages 10 to 19 for actuator and auto switch precautions.

Pneumatic Circuit

Warning

1. Recommended pneumatic circuit for the CKQG/P series

The following is an example of a basic meter-out control circuit for operating a cylinder using an air filter, a regulator, a solenoid valve and a speed controller.

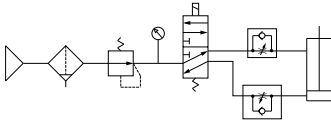

Recommended pneumatic circuit

2. Recommended pneumatic circuit for the CLKQG/P series

• Drop prevention circuit

1) Do not use 3 position valves with circuit example 1.

The lock may be released due to inflow of the unlocking pressure.

2) Install speed controllers as meter-out control. (Circuit example 1)

When they are not installed or they are used under meter-in control, it may cause malfunction.

3) Branch off the compressed air piping for the lock unit between the cylinder and the speed controller. (Circuit example 1)

Note that branching off in other sections may shorten the service life.

4) Perform piping so that the unlocking port side going from the piping junction is short. (Circuit example 1)

If the piping of unlocking port side is longer than that of the cylinder port from the piping junction, this may cause unlocking malfunction or shorten the service life.

5) Be aware of reverse exhaust pressure flow from common exhaust type valve manifolds. (Circuit example 1)

Since the lock may be released due to reverse exhaust pressure flow, use an individual exhaust type manifold or single type valve.

6) Be sure to release the lock before operating the cylinder. (Circuit example 2)

When the lock release delays, a cylinder may eject at high speed, which is extremely dangerous. It may also damage the cylinder, greatly shorten the service life or cause locking malfunction. Even when the cylinder moves freely, be sure to release the lock and operate the cylinder.

7) Be aware that the locking action may be delayed due to the piping length or the timing of exhaust. (Circuit example 2)

The locking action may be delayed due to the piping length or the timing of exhaust, which also makes the stroke movement toward the lock larger. Install the solenoid valve for locking closer to the cylinder than the cylinder drive solenoid valve.

• Emergency stop circuit

1) Perform emergency stops with the pneumatic circuit. (Circuit examples 3 and 4)

This cylinder is designed for locking against inadvertent movement from a stationary condition. Do not perform intermediate stops while the cylinder is operating, as this may damage the cylinder, cause unlocking malfunction or shorten the service life. Emergency stops must be performed with the pneumatic circuit, and workpieces must be held with the locking mechanism after the cylinder fully stops.

2) When restarting the cylinder from the locked state, remove the workpiece and exhaust the residual pressure in the cylinder. (Circuit examples 3 and 4)

A cylinder may eject at high speed, which is extremely dangerous. It may also damage the cylinder, greatly shorten the service life or cause locking malfunction.

3) Be sure to release the lock before operating the cylinder. (Circuit example 4)

When the lock release delays, the cylinder may eject at high speed, which is extremely dangerous. It may also damage the cylinder, greatly shorten the service life or cause locking malfunction. Even when the cylinder moves freely, be sure to release the lock and operate the cylinder.

• Drop prevention circuit, Emergency stop circuit

1) If installing a solenoid valve for a lock unit, be aware that repeated supply and exhaustion of air may cause condensation. (Circuit examples 2 and 4)

The lock unit operating stroke is very small and so the pipe is long. If supplying and exhausting air repeatedly, condensation, which occurs by adiabatic expansion, accumulates in the lock unit. This may then cause air leakage and an unlocking malfunction due to corrosion of internal parts.

Circuit example

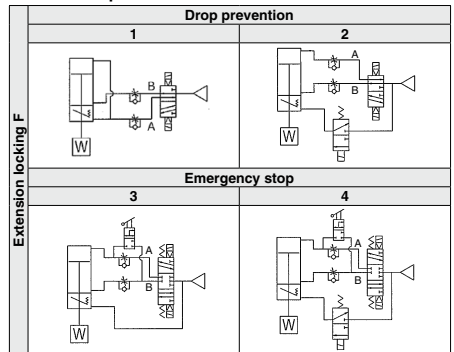

Mounting

Caution

1. Do not use the cylinder until it is confirmed that the equipment is operating correctly.

After installation, maintenance or replacement, connect the compressed air or electricity and verify that the installation is correct by performing appropriate function and/or leakage tests.

2. Do not dent the cylinder tube or the guide pin parts.

Slight deformation will cause a malfunction since the tube I.D. is manufactured with a tight tolerance. Excessive impact will cause damage to the guide pin because it is heat treated.

3. Prevent any foreign materials, such as machining chips, from entering into internal cylinder from the air supply port.

When the mounting holes for the cylinder are made, machined chips may enter the cylinder from the air supply port if the cylinder is left near the installation site. Prevent the machining chips from entering into the cylinder.

4. The opening part of a guide pin should not face in the same direction as oncoming spatter.

If the spatter enters the cylinder from the opening part of the guide pin, it will shorten the product life and cause a malfunction.



CKQ^G_P□/CLKQ^G_P□ Series

Specific Product Precautions 4

Be sure to read this before handling the products. Refer to page 9 for safety instructions and pages 10 to 19 for actuator and auto switch precautions.

Mounting

⚠ Caution

5. Consider the welding point of the guide pin when determining the direction of the clamp arm setting.

The clamp arm will be damaged if clamping is performed at the welded point of the guide pin. Therefore, set the clamping direction as illustrated below, so that the welded point is not effected by clamping.

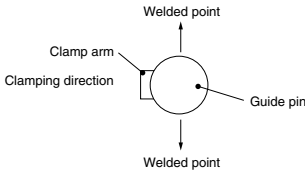

6. When assembling and adjusting the product, begin the task by applying pressure only to the unlocking port (for the CLKQG/P series only).

7. When attaching a cylinder to the equipment, use the tightening torque specified in the below table.

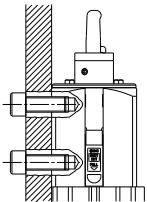

Thread size	Tightening torque [N·m]
M10	20 to 25
M12	35 to 42

8. Check the auto switch operation when the product is used where welding is performed.

9. When installing a cylinder with an auto switch, secure enough space on the bottom side of the cylinder providing the minimum bending radius for the lead wire to permit better serviceability (such as replacement of groove mounting auto switches).

10. Operating manual

Install the products and operate them only after reading the operating manual carefully and understanding its contents. Also, keep the manual where it can be referred to as necessary.

Piping

⚠ Caution

1. Before piping

Before piping, it should be thoroughly blown out with air (flushing) or washed to remove chips, cutting oil and other debris from inside the pipe.

2. Wrapping of sealant tape

When screwing piping or fittings into ports, ensure that chips from the pipe threads or sealing material do not get inside the piping. Also, when the sealant tape is used, leave 1.5 to 2 thread ridges exposed at the end of the threads.

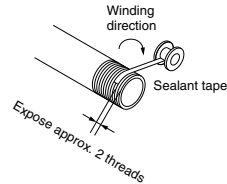

3. Piping length should be short.

If the piping to the cylinder is too long, the volume of water vapor in the internal tubing increases beyond that of the internal cylinder due to the generation of water vapor by adiabatic expansion. Since the water vapor stays inside of the tubing without being released into the air, repeated operation results in the generation of water. Grease in the cylinder is drained out as it flows away with the water. This action lowers the smoothness in the cylinder, resulting in air leakage due to worn out seals, and or malfunction due to increased friction resistance. Please do the following to prevent this problem:

- 1) Tubing from a solenoid valve to a cylinder should be as short as possible to assure the evacuation of the generated water vapor into the air. As a guide, the air capacity in the cylinder, which when converted to atmospheric pressure x 0.7 should be \geq the piped tubing capacity.
- 2) Pipe a speed exhaust controller ASV and a quick exhaust valve to a cylinder to exhaust the exhaust pressure directly to the air.
- 3) Piping port should face downward so that the generated moisture inside tubing does not easily return to the cylinder.



CKQG^G□/CLKQG^G□ Series

Specific Product Precautions 5

Be sure to read this before handling the products. Refer to page 9 for safety instructions and pages 10 to 19 for actuator and auto switch precautions.

Lubrication

⚠ Caution

1. Lubrication for the CKQG/P cylinder

The cylinder is lubricated at the factory, and can be used without further lubrication.

In the event that lubricant is used, install a lubricator in the circuit and use Class 1 turbine oil (without additives) ISO VG-32. A malfunction can occur due to loss of the original lubricant if lubrication is stopped in the future. Therefore, once lubrication is applied, it must be used continuously.

2. Lubrication for the CLKQG/P cylinder

Do not lubricate because it may considerably lower the locking performance.

Maintenance

⚠ Caution

1. If spatter enters the cylinder body, remove it by first detaching the covers. Do not scratch or make dents on the sliding parts of the piston rod by striking it with other objects or grasping them with other objects.

Since the outside diameter of a piston rod is manufactured with a tight tolerance, even a slight deformation can cause an operation malfunction.

Any scratches and dents on the sliding parts of the piston rod can cause damage to the seals, resulting in air leakage.

2. To release the cover, insert a flat head screwdriver in the notch on the cover and apply force.

If a finger is used to remove the cover, the edge of the cover's notch may injure the finger.

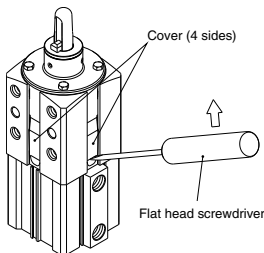

3. Drain flushing

Remove drainage from air filters regularly. (Refer to the specifications.)

Handling

Magnetic field resistant auto switches D-P79WSE/D-P74□ type are specifically for use with magnetic field resistant cylinders and are not compatible with general auto switches or cylinders. Magnetic field resistant cylinders are labeled as follows.

Magnetic field resistant cylinder with built-in magnet
(For use with auto switch D-P7 type)

Mounting

1. In order to fully use the capacity of magnetic field resistant auto switches, strictly observe the following precautions.

- 1) Do not allow the magnetic field to occur when the cylinder piston is moving.
- 2) When a welding cable or welding gun electrodes are near the cylinder, change the auto switch position to fall within the operational ranges shown in the graphs on page 543, or move the welding cable away from the cylinder.
- 3) Cannot be used in an environment where welding cables surround the cylinder.
- 4) Consult SMC when a welding cable and welding gun electrodes (something energized with secondary current) are near multiple switches.

2. In an environment where spatter directly hits the lead wire, cover the lead wire with protective tubing. Use protective tubing I.D. $\phi 8$ or more that has excellent heat resistance and flexibility.

Contact Capacity

Never operate a load that exceeds the maximum contact capacity of the auto switch.



CKQ^G□/CLKQ^G□ Series

Specific Product Precautions 6

Be sure to read this before handling the products. Refer to page 9 for safety instructions and pages 10 to 19 for actuator and auto switch precautions.

Data: Magnetic Field Resistant Reed Switch (D-P79WSE type, D-P74□ type) Safety Distance

Safety Distance from Side of Auto Switch

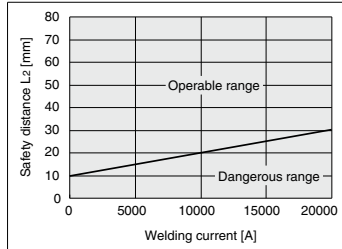
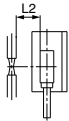
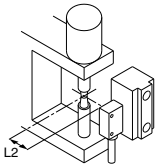
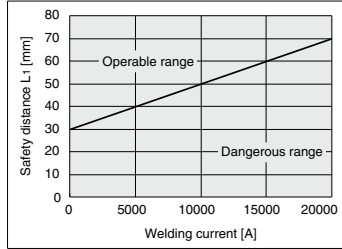
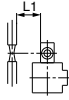
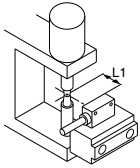

Safety Distance from Top of Auto Switch

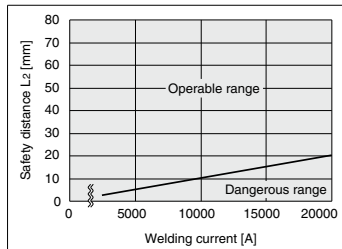
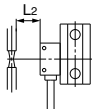
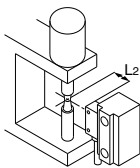
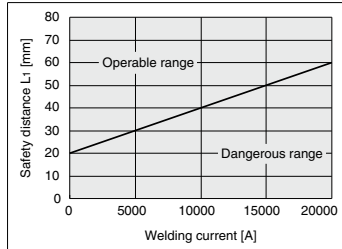
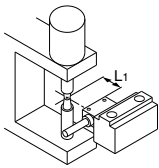



CKQ^G_P□/CLKQ^G_P□ Series

Specific Product Precautions 7

Be sure to read this before handling the products. Refer to page 9 for safety instructions and pages 10 to 19 for actuator and auto switch precautions.

Operation

⚠ Warning

1. Do not unlock when an external force, such as a load or spring force is being applied.

This is very dangerous because the cylinder will move suddenly. Take the following steps.

- 1) Restore the air pressure in the B line of the pneumatic circuit to operating pressure. Once restored, gradually let the air pressure drop.
- 2) If air pressure cannot be used, prevent cylinder movement with a lifting device such as a jack, then release the lock.

2. After all safety precautions have been confirmed, perform the manual release by following the steps shown below.

Carefully confirm that no one is inside the load movement range, that there is no danger even if the load moves suddenly, etc.

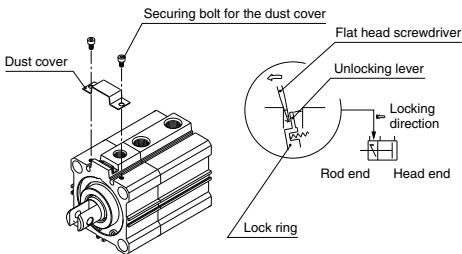

How to unlock manually

- 1) Remove the dust cover.
- 2) Insert a flat head screwdriver on the rod end of the manual unlocking lever as shown in the figure above, and lightly push the screwdriver in the direction of the arrow (rod end) to unlock.