

# Fine Lock Cylinders



## CL□ Series

ø16, ø20, ø25, ø32, ø40

Locking method	Spring locking	Pneumatic locking	Spring and pneumatic locking
Features	<ul style="list-style-type: none"> <li>• Unlocking Discharging the air causes the lock to operate.</li> </ul>	<ul style="list-style-type: none"> <li>• Pressure locking The holding power can be varied according to the air pressure that is applied to the port.</li> </ul>	<ul style="list-style-type: none"> <li>• Pressure locking The holding power can be varied according to the air pressure that is applied to the port.</li> <li>• Unlocking Discharging the air causes the lock to operate.</li> </ul>

**Locking in both directions is possible.**  
Locking in either side of cylinder stroke is possible, too.

### Series Variations

Series	Action	Rod	Standard variations		Locking direction	Locking method			Bore size (mm)	Standard stroke (mm)	Page
			Auto switch built-in magnet	With rod boot		Spring locking	Pneumatic locking	Spring and pneumatic locking			
<b>CLJ2 Series</b> 	Double acting	Single rod	●		Both directions	●	●	●	16	15 to 200	965
<b>CLM2 Series</b> 	Double acting	Single rod	●	●	Both directions	●	●	●	20 25 32 40	25 to 300	975
<b>CLG1 Series</b> 	Double acting	Single rod	●	●	Both directions	●	●	●	20 25 32 40	25 to 300	992

# CL□ Series Prior to Use

## Construction Principle/Applicable Series: CLJ2, CLM2, CLG1, MLGC

### Spring locking type

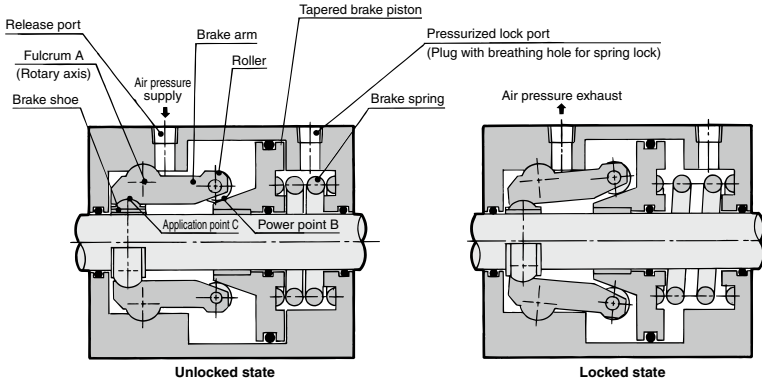

#### Spring locking (Exhaust locking)

The spring force that is applied to the tapered brake piston becomes amplified through the wedge effect. This force becomes further amplified to the power of AB/AC through the mechanical advantage of a lever and acts on the brake shoe, which in turn, applies a large force to tighten and lock the piston rod. To disengage the lock, air pressure is supplied through the unlocking port, thus disengaging the brake spring force.

### Pneumatic locking type

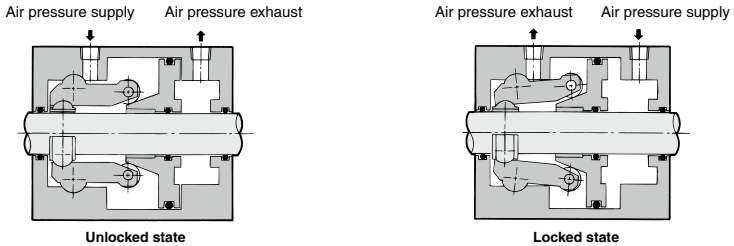

Brake piston is operated by air pressure.

### Spring and pneumatic locking type

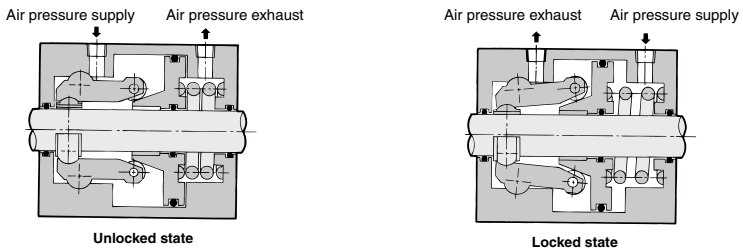

Brake piston is operated by air pressure and spring force.

# Fine Lock Cylinder

## Double Acting, Single Rod

# CLJ2 Series

ø16

### How to Order

**CLJ2 L 16 - 60 R - E - [ ]**

**With auto switch** **CDLJ2 L 16 - 60 R - E - M9BW [ ] - C - [ ]**

**With auto switch**  
(Built-in magnet)

**Mounting type**

B	Basic type
L	Axial foot type
F	Rod side flange type
D	Double clevis type

**Bore size**  
16 | 16 mm

**Standard stroke (mm)**  
ø16 15, 30, 45, 60, 75, 100, 125, 150, 175, 200

**Port location on head cover**

Nil	Perpendicular to axis
R	Axial direction

**Lock operation**

E	Spring locking (Exhaust locking)
P	Pneumatic locking (Pressure locking)
D	Spring and pneumatic locking

**Auto switch**

Nil	Without auto switch
-----	---------------------

**Number of auto switches**

Nil	2 pcs.
S	1 pc.
n	"n" pcs.

**Made to Order**  
Refer to page 966 for details.

**Auto switch mounting bracket**<sup>(Note)</sup>  
Note) This symbol is indicated when the D-A9□ or M9□ type auto switch is specified. This mounting bracket does not apply to other auto switches (D-C7□ and H7□, etc.) (Nil)

**Built-in Magnet Cylinder Model**

If a built-in magnet cylinder without an auto switch is required, there is no need to enter the symbol for the auto switch.  
(Example) CDLJ2B16-45-P

\* For the applicable auto switch model, refer to the table below.

### Applicable Auto Switches

Refer to pages 1341 to 1435 for further information on auto switches.

Type	Special function	Electrical entry	Indicator light	Wiring (Output)	Load voltage		Auto switch model				Lead wire length (m)				Pre-wired connector	Applicable load				
					DC	AC	Band mounting		Rail mounting		0.5 (Nil)	1 (M)	3 (L)	5 (Z)			None (N)			
							Perpendicular	In-line	Perpendicular	In-line										
Solid state auto switch	—	Grommet	—	3-wire (NPN)	5 V, 12 V	—	M9NV	M9N	M9NV	M9N	●	●	●	○	○	IC circuit				
				3-wire (PNP)			M9PV	M9P	M9PV	M9P	●	●	●	○	○					
		Connector	—	2-wire	M9BV	M9B	M9BV	M9B	●	●	●	○	○	—						
				—	H7C	J79C	—	●	●	●	●	—	—							
	Diagnostic indication (2-color indicator)	Grommet	Yes	—	3-wire (NPN)	5 V, 12 V	—	M9NVV	M9NW	M9NVV	M9NW	●	●	●	○	○	Relay, PLC			
					3-wire (PNP)			M9PVV	M9PW	M9PVV	M9PW	●	●	●	○	○				
					2-wire			M9BVV	M9BV	M9BVV	M9BV	●	●	●	○	○				
					3-wire (NPN)			M9NAV*1	M9NA*1	M9NAV*1	M9NA*1	○	○	●	○	○		IC circuit		
					3-wire (PNP)			M9PAV*1	M9PA*1	M9PAV*1	M9PA*1	○	○	●	○	○				
					2-wire			M9BAV*1	M9BA*1	M9BAV*1	M9BA*1	○	○	●	○	○				
4-wire (NPN)	—	H7NF	—	F79F	●	—	●	○	○	○	IC circuit									
Reed auto switch	—	Grommet	Yes	3-wire (NPN equivalent)	5 V	—	A96V	A96	A96V	A96	●	—	●	—	—	IC circuit				
							—	200 V	—	A72	A72H	●	—	●	—		—			
							100 V	A93V*2	A93	A93V*2	A93	●	●	●	●		—	—		
							100 V or less	A90V	A90	A90V	A90	●	●	●	●		—	IC circuit		
		Connector	No	2-wire	—	24 V	12 V	—	—	C73C	A73C	—	●	—	●	●	—	IC circuit		
									—	—	A79W	—	●	—	●	●	—		—	
									24 V or less	C80C	A80C	—	●	—	●	●	●		—	IC circuit
									—	—	A79W	—	●	—	●	●	●		—	—

\*1 Water resistant type auto switches can be mounted on the above models, but in such case SMC cannot guarantee water resistance. Consult with SMC regarding water resistant types with the above model numbers.

\*2 1 m type lead wire is only applicable to D-A93.

\* Lead wire length symbols: 0.5 m ..... Nil (Example) M9NW  
1 m ..... M (Example) M9NWM  
3 m ..... L (Example) M9NWL  
5 m ..... Z (Example) M9NWZ  
None ..... N (Example) H7CN

\* Since there are other applicable auto switches than listed, refer to page 974 for details.

\* For details about auto switches with pre-wired connector, refer to pages 1410 and 1411.

\* Solid state auto switches marked with "○" are produced upon receipt of order.

\* The D-A9□, M9□, M9□W, A7□□, A80□, F7□□, J7□□ auto switches are shipped together, (but not assembled).

(However, only the auto switch mounting brackets are assembled for band mounting before shipment.)

# CLJ2 Series

**Provided with a compact lock mechanism, it is suitable for intermediate stop, emergency stop, and drop prevention.**

## Locking in both directions

The piston rod can be locked in either direction of its cylinder stroke.

## Maximum piston speed: 500 mm/s

It can be used at 50 to 500 mm/s provided that it is within the allowable kinetic energy range.

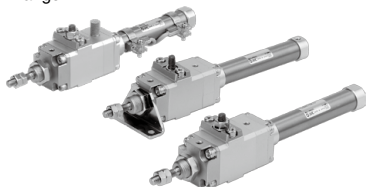

## Head Cover Port Location

Either perpendicular to the cylinder axis or in-line with the cylinder axis is available for basic type.



Axial



Perpendicular

## Symbol

Rubber bumper

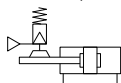

## Made to Order Specifications

[Click here for details](#)

Symbol	Specifications
-XA□	Change of rod end shape

Refer to pages 972 to 974 for cylinders with auto switches.

- Minimum auto switch mounting stroke
- Proper auto switch mounting position (detection at stroke end) and mounting height
- Operating range
- Switch mounting bracket: Part no.

## Specifications

Bore size (mm)	16
Action	Double acting, Single rod
Lubricant	Not required (Non-lube)
Lock operation	Spring locking (Exhaust locking) Pneumatic locking (Pressure locking) Spring and pneumatic locking
Fluid	Air
Proof pressure	1.05 MPa
Maximum operating pressure	0.7 MPa
Minimum operating pressure	0.08 MPa
Ambient and fluid temperature	Without auto switch: -10 to 70°C (No freezing) With auto switch: -10 to 60°C (No freezing)
Piston speed	50 to 500 mm/s *
Cushion	Rubber bumper
Stroke length tolerance	$\begin{matrix} +1.0 \\ 0 \end{matrix}$
Mounting	Basic type, Axial foot type, Rod side flange type, Double clevis type

\* Constraints associated with the allowable kinetic energy are imposed on the speeds at which the piston can be locked.  
The maximum speed of 750 mm/s can be accommodated if the piston is to be locked in the stationary state for the purpose of drop prevention.

## Fine Lock Specifications

Lock operation	Spring locking (Exhaust locking)	Spring and pneumatic locking	Pneumatic locking (Pressure locking)
Fluid	Air		
Maximum operating pressure	0.5 MPa		
Unlocking pressure	0.3 MPa or more		0.1 MPa or more
Lock starting pressure	0.25 MPa or less		0.05 MPa or more
Locking direction	Both directions		

## Standard Stroke

Refer to the minimum auto switch mounting stroke (page 973) for those with an auto switch. (mm)

Bore size (mm)	Standard stroke
16	15, 30, 45, 60, 75, 100, 125, 150, 175, 200

\* Manufacture of intermediate strokes at 1 mm intervals is possible. (Spacers are not used.)

## Mounting Bracket and Accessory

For details about part numbers and dimensions, refer to page 971.

Mounting		Basic type	Axial foot type	Rod side flange type	Double clevis type
Standard equipment	Mounting nut	●	●	●	—
	Rod end nut	●	●	●	●
	Clevis pin	—	—	—	●
Option	Single knuckle joint	●	●	●	●
	Double knuckle joint (With pin) *	●	●	●	●
	T-bracket	—	—	—	●

\* Pins and retaining rings are packaged together with double clevis and double knuckle joint.

## Mounting Bracket Part No.

Mounting bracket	Part no.
Foot	CLJ-L016B
Flange	CLJ-F016B
T-bracket *	CJ-T016C

\* T-bracket is used with double clevis (D).

### Weight

(g)

Bore size (mm)		<b>16</b>
Standard weight *		320
Additional weight per each 15 mm of stroke		6.5
Mounting bracket Weight	Axial foot type	27
	Rod side flange type	21
	Double clevis type (With pin) **	10

\* Mounting nut and rod end nut are included in the basic weight.

\*\* Mounting nut is not included in double clevis type.

Calculation: (Example) **CLJ2L16-60**

- Basic weight.....320 (ø16)
  - Additional weight.....6.5/15 stroke
  - Cylinder stroke.....60 stroke
- 320 + 6.5/15 x 60 + 27 = 373 g

### Stopping Accuracy (Not including tolerance of control system.) (mm)

Lock type	Piston speed (mm/s)			
	50	100	300	500
Spring locking (Exhaust locking)	± 0.4	± 0.5	± 1.0	± 2.0
Pneumatic locking (Pressure locking) Spring and pneumatic locking	± 0.2	± 0.3	± 0.5	± 1.5

Condition: Load: 2 kg

Solenoid valve: Lock port mounting

### ⚠ Caution

Selection/Recommended Pneumatic Circuit/Caution on Handling

For detailed specifications of the fine lock cylinder, CLJ2 series mentioned above, refer to pages 1004 to 1007.

### ⚠ Caution/Allowable Kinetic Energy when Locking

Bore size (mm)	<b>16</b>
Allowable kinetic energy (J)	0.17

1. In terms of specific load conditions, this allowable kinetic energy is equivalent to a load of 3.7 kg in mass, and a piston speed of 300 mm/sec. Therefore, if the operating conditions are below these values, there is no need to calculate.
2. Apply the following formula to obtain the kinetic energy of the load.  

$$E_k = \frac{1}{2} m v^2$$

$$E_k: \text{Kinetic energy of load (J)}$$

$$m: \text{Load mass (kg)}$$

$$v: \text{Piston speed (m/s)}$$
3. The piston speed will exceed the average speed immediately before locking. To determine the piston speed for the purpose of obtaining the kinetic energy of load, use 1.2 times the average speed as a guide.
4. The relationship between the speed and the load is indicated in the graph below. The area below the line is the allowable kinetic energy range.
5. There is an upper limit to the size of the load that can be sustained. Thus, a horizontally mounted cylinder must be operated below the solid line, and a vertically mounted cylinder must be operated below the dotted line.

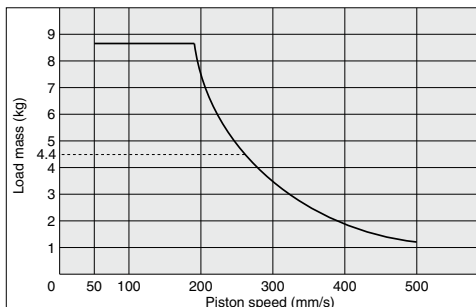

### Holding Force of Spring Locking (Maximum static load)

Bore size (mm)	<b>16</b>
Holding force (N)	122

Note) Holding force at piston rod extended side decreases approximately 15%.

### Holding Force of Pneumatic Locking (Maximum static load)

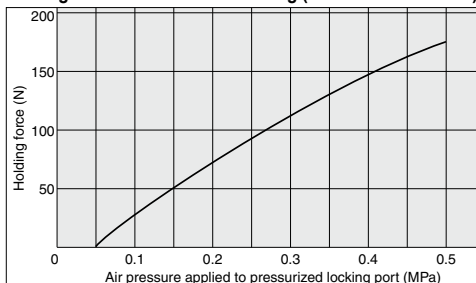

\* When selecting cylinders, refer to the Precautions and allowable kinetic energy when locking on page 1004, and then select a cylinder.

### ⚠ Caution

#### Caution when Locking

Holding force (maximum static load) means the maximum capability of holding a static load that is not accompanied by vibration or impact under the condition that no load is applied. Therefore, it does not refer to a load that cannot be held constantly.

When using (selecting) this product, carefully check the following points.

- If the piston rod slips because the lock's holding force has been exceeded, the brake shoe could be damaged, resulting in a reduced holding force or shortened life.
- The upper limit of the load that is used under the conditions not associated with the kinetic energy when locking, such as drop prevention must be 35% or less of the holding force.
- Do not use the cylinder in the locked state to sustain a load that involves impact.

# CLJ2 Series

## Construction (Not able to disassemble)

### Spring locking (Exhaust locking) Spring and pneumatic locking

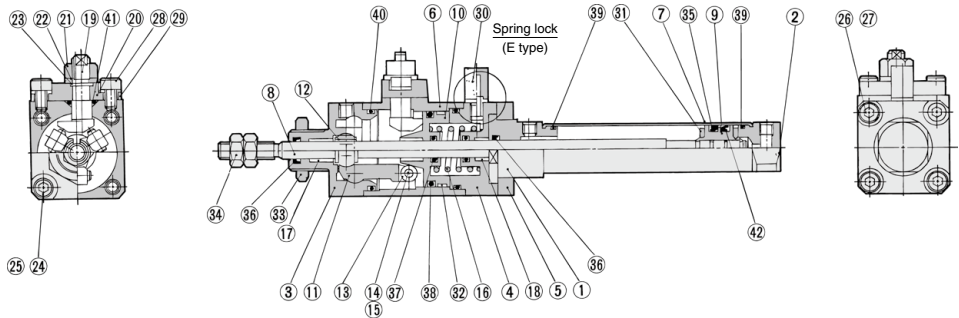

### Pneumatic locking (Pressure locking)

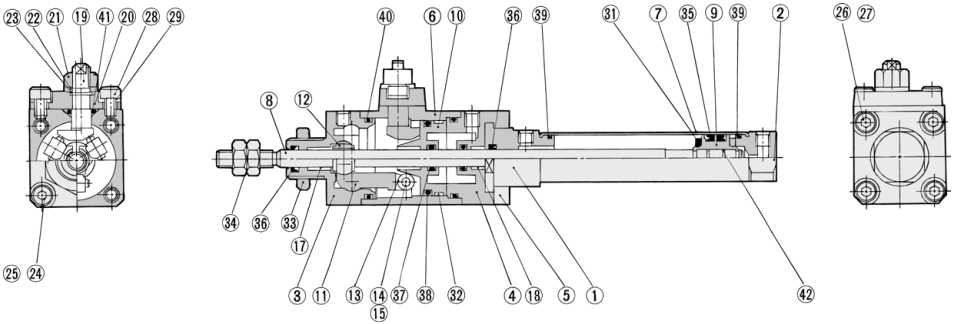

### Component Parts

No.	Description	Material	Note
1	Rod cover	Aluminum alloy	Clear anodized
2	Head cover	Aluminum alloy	Clear anodized
3	Cover A	Carbon steel	Nitrided, nickel chrome plated
4	Cover B	Aluminum alloy	Hard anodized
5	Cover C	Aluminum alloy	Hard anodized
6	Intermediate cover	Aluminum alloy	Hard anodized
7	Cylinder tube	Stainless steel	
8	Piston rod	Stainless steel	Hard chrome plated
9	Piston	Aluminum alloy	Chromated
10	Brake piston	Carbon steel	Nitrided
11	Brake arm	Carbon steel	Nitrided
12	Brake shoe	Special friction material	
13	Roller	Carbon steel	Nitrided
14	Pin	Carbon steel	Heat treated
15	Retaining ring	Carbon tool steel	
16	Brake spring	Steel wire	Zinc chromated
17	Bushing A	Bearing alloy	
18	Bushing B	Bearing alloy	
19	Manual lock release cam	Chromium molybdenum steel	Nitrided
20	Cam guide	Carbon steel	Nitrided, platinum silver painted
21	Lock nut	Rolled steel	

No.	Description	Material	Note
22	Plain washer	Rolled steel	
23	Retaining ring	Carbon tool steel	
24	Hexagon socket head cap screw	Chromium molybdenum steel	
25	Spring washer	Steel wire	
26	Hexagon socket head cap screw	Chromium molybdenum steel	
27	Spring washer	Steel wire	
28	Hexagon socket head cap screw	Chromium molybdenum steel	
29	Spring washer	Steel wire	
30	Silencer	Bronze	Type E only
31	Bumper	Urethane	
32	Wear ring	Resin	
33	Mounting nut	Brass	
34	Rod end nut	Rolled steel	
35	Piston seal	NBR	
36	Rod seal A	NBR	
37	Rod seal B	NBR	
38	Brake piston seal	NBR	
39	Cylinder tube gasket	NBR	
40	Intermediate cover gasket	NBR	
41	Cam gasket	NBR	
42	Piston gasket	NBR	

### Basic Type (B)

CLJ2B16-□□-□<sub>B</sub>

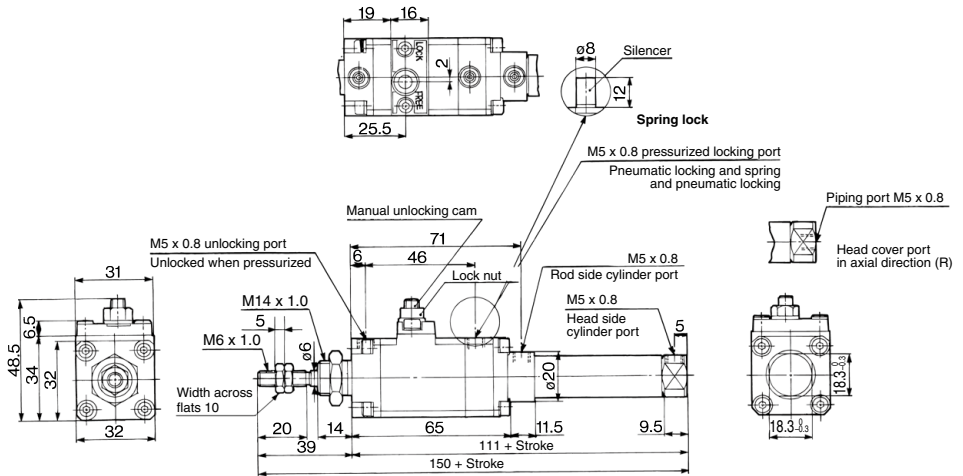

### Axial Foot Type (L)

CLJ2L16-□□-□<sub>L</sub>

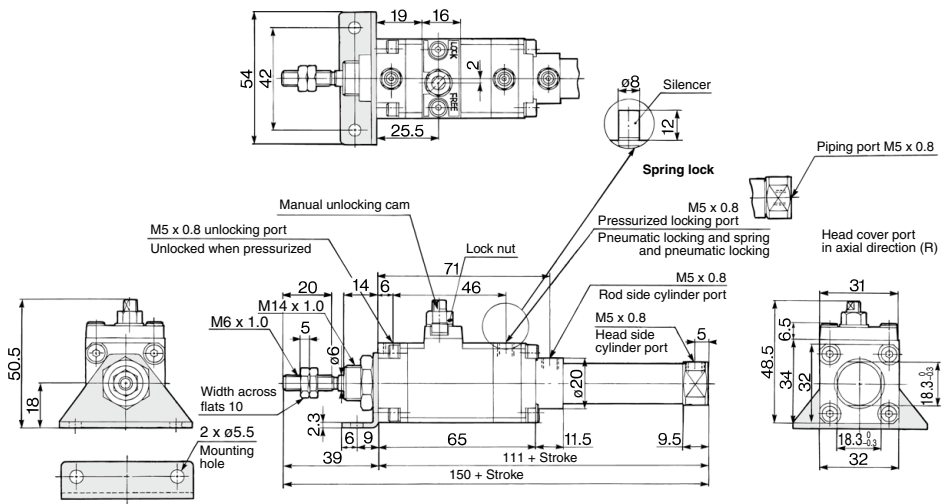

# CLJ2 Series

## Rod Side Flange Type (F)

CLJ2F16-□□- $\frac{F}{P}$

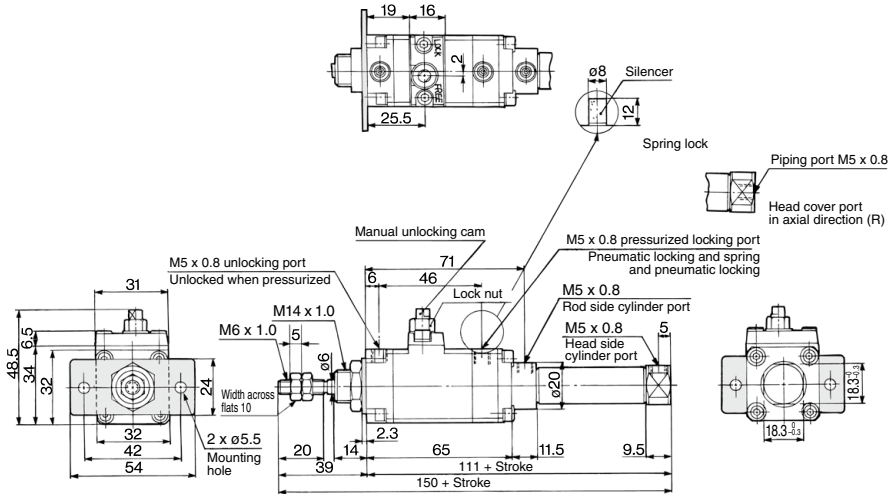

## Double Clevis Type (D) \* Clevis pin and retaining ring are shipped together.

CLJ2D16-□□- $\frac{F}{P}$

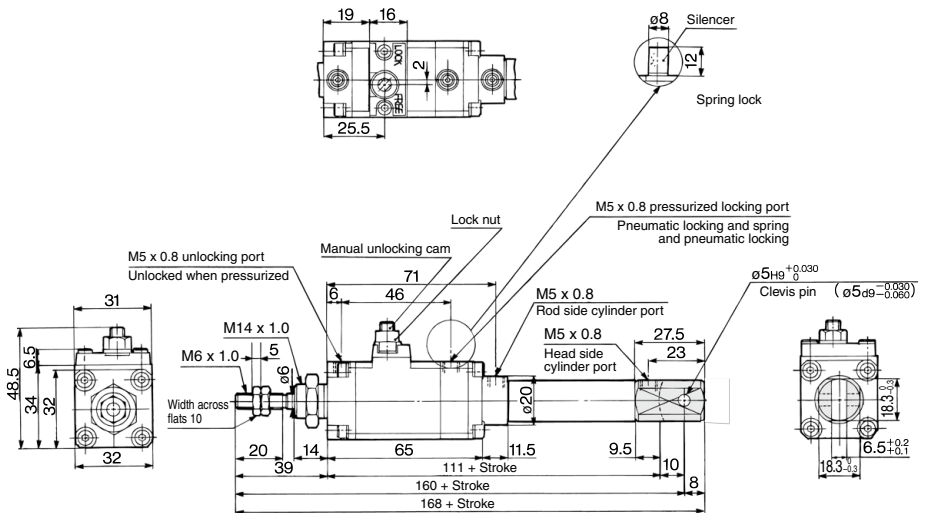



# Accessory Bracket Dimensions

## Accessory Bracket Dimensions

### Single Knuckle Joint: I-LJ016B

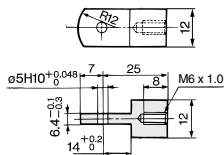

Material: Rolled steel

### Double Knuckle Joint: Y-LJ016B

\* Knuckle pin and retaining ring are shipped together.

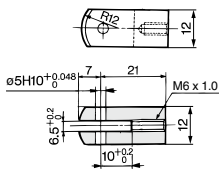

Material: Rolled steel

### Rod End Nut: NT-015A

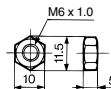

Material: Rolled steel

### Clevis Pin: CD-Z015

\* Retaining rings are shipped together.

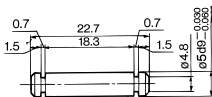

Material: Stainless steel

### Knuckle Pin: IY-J015A

\* Retaining rings are shipped together.

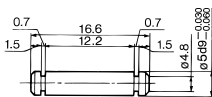

Material: Stainless steel

### Mounting Nut: SNLJ-016C

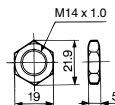

Material: Brass

### T-bracket: CJ-T016C

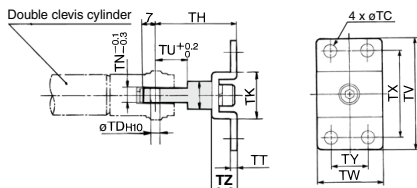

Material: Rolled steel

Part no.	Bore size (mm)	TC	TDH10	TH	TK	TN	TT	TU	TV	TW	TX	TY	TZ
<b>CJ-T016C</b>	<b>16</b>	5.5	5 <sup>+0.048</sup>	35	20	6.4	2.3	14	48	28	38	16	10

\* T-bracket includes a T-bracket base, single knuckle joint, hexagon socket head cap screw and spring washer.

# Auto Switch Mounting 1

## Auto Switch Proper Mounting Position (Detection at Stroke End) and Its Mounting Height

Reed auto switch  
<Band Mounting>

D-A9□

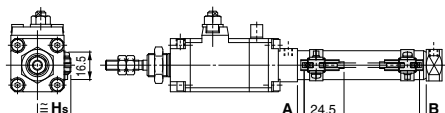

( ) : For D-A96

D-C7□/C80

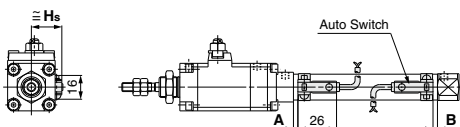

D-C73C□/C80C

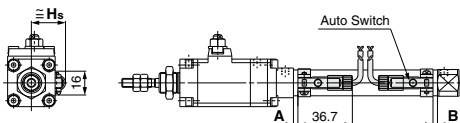

Solid state auto switch  
<Band Mounting>

D-M9□  
D-M9□A  
D-M9□W

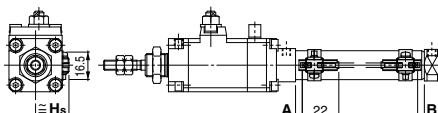

( ) : For D-M9□A

D-H7□  
D-H7□W  
D-H7BA  
D-H7NF

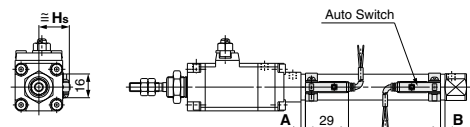

D-H7C

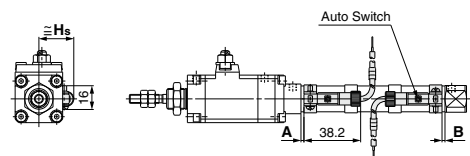

## Auto Switch Proper Mounting Position (Detection at Stroke End) and Its Mounting Height

### Auto Switch Proper Mounting Position

(mm)

Auto switch model	D-M9□(V) D-M9□W(V) D-M9□A(V)		D-A9□(V)		D-C7/C8 D-C73C D-C80C		D-H7□ D-H7C D-H7□W D-H7BA D-H7NF	
	A	B	A	B	A	B	A	B
Bore size (mm) <b>16</b>	6.5	6.5	2.5	2.5	3	3	2	2

Note) Adjust the auto switch after confirming the operating conditions in the actual setting.

### Auto Switch Mounting Height

(mm)

Auto switch model	D-M9□(V) D-M9□W(V) D-M9□A(V) D-A9□(V)		D-C7/C8 D-H7□ D-H7□W D-H7NF D-H7BA		D-C73C D-C80C		D-H7C	
	Hs		Hs		Hs		Hs	
Bore size (mm) <b>16</b>	21		20.5		23		23.5	

### Minimum Auto Switch Mounting Stroke

		(mm)				
Auto switch mounting	Auto switch model	No. of auto switches mounted				
		1	2		n (n: No. of auto switches)	
			Different surfaces	Same surface	Different surfaces	Same surface
Band mounting	D-M9□ D-M9□W D-M9□A D-A9□	10	15 Note 1)	45 Note 1)	$15 + 35 \frac{(n-2)}{2}$ (n = 2, 4, 6... Note 3)	45 + 15 (n - 2) (n = 2, 3, 4, 5...)
	D-M9□V	5	15 Note 1)	35	$15 + 35 \frac{(n-2)}{2}$ (n = 2, 4, 6... Note 3)	35 + 25 (n - 2) (n = 2, 3, 4, 5...)
	D-M9□WV D-M9□AV	10	15 Note 1)	35	$15 + 35 \frac{(n-2)}{2}$ (n = 2, 4, 6... Note 3)	35 + 25 (n - 2) (n = 2, 3, 4, 5...)
	D-A9□V	5	10	35	$10 + 35 \frac{(n-2)}{2}$ (n = 2, 4, 6... Note 3)	35 + 25 (n - 2) (n = 2, 3, 4, 5...)
	D-C7□ D-C80	10	15	50	$15 + 40 \frac{(n-2)}{2}$ (n = 2, 4, 6... Note 3)	50 + 20 (n - 2) (n = 2, 3, 4, 5...)
	D-H7□/H7□W D-H7BA D-H7NF	10	15	60	$15 + 45 \frac{(n-2)}{2}$ (n = 2, 4, 6... Note 3)	60 + 22.5 (n - 2) (n = 2, 3, 4, 5...)
	D-C73C D-C80C D-H7C	10	15	65	$15 + 50 \frac{(n-2)}{2}$ (n = 2, 4, 6... Note 3)	50 + 27.5 (n - 2) (n = 2, 3, 4, 5...)

Note 3) When "n" is an odd number, an even number that is one larger than this odd number is used for the calculation.

Note 1) Auto switch mounting.

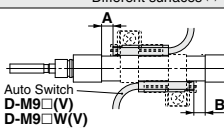
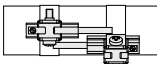
Auto switch model	With 2 auto switches	
	Different surfaces (1)	Same surface (1)
	 <p>Auto Switch D-M9□(V) D-M9□W(V) D-M9□A(V)</p> <p>The proper auto switch mounting position is 5.5 mm inward from the switch holder edge. The above A and B indicate values for band mounting in the table of page 972</p>	 <p>The auto switch is mounted by slightly displacing it in a direction (cylinder tube circumferential exterior) so that the auto switch and lead wire do not interfere with each other.</p>
D-M9□/M9□W/M9□A	Less than 20 stroke Note2)	Less than 55 stroke Note2)
D-A90/A93	—	Less than 50 stroke Note2)

Note 2) Minimum stroke for auto switch mounting in types other than those mentioned in Note 1.

### Operating Range

Auto switch model	(mm)
	Bore size (mm)
	<b>16</b>
D-A9□	7
D-M9□ D-M9□W	3
D-C7□/C80 D-C73C/C80C	7
D-H7□/H7□W/H7BA/H7NF	4
D-H7C	9

\* Since the operating range is provided as a guideline including hysteresis, it cannot be guaranteed (assuming approximately ±30% dispersion). It may vary substantially depending on an ambient environment.

# Auto Switch Mounting 2

## Auto Switch Mounting Bracket: Part No.

Auto switch mounting	Auto switch model	Bore size (mm)	
		10	16
Band mounting	D-M9□ D-M9□V D-M9□W D-M9□WV D-A9□ D-A9□V	Note 1) BJ6-010	Note 1) BJ6-016
	D-M9□A D-M9□AV	Note 2) BJ6-010S	Note 2) BJ6-016S
	D-C7□/C80 D-C73C/C80C D-H7□/H7□W D-H7BA/H7NF	BJ2-010	BJ2-016

Note 1) Set part number which includes the auto switch mounting band (BJ2-□□□) and the holder kit (BJ5-1/Switch bracket: Transparent). Since the switch bracket (made from nylon) are affected in an environment where alcohol, chloroform, methylamines, hydrochloric acid or sulfuric acid is splashed over, so it cannot be used. Please consult SMC regarding other chemicals.

Note 2) Set part number which includes the auto switch mounting band (BJ2-□□□S) and the holder kit (BJ4-1/Switch bracket: White).

Note 3) For the D-M9□A (V) type auto switch, do not install the switch bracket on the indicator light.

### [Mounting screw set made of stainless steel]

The following set of mounting screws made of stainless steel is available. Use it in accordance with the operating environment. (Please order the auto switch mounting bracket separately, since it is not included.)

BBA4: For D-C7/C8/H7 types

Note 2) Refer to page 1440 for the details of BBA4.

D-H7BAL auto switch is set on the cylinder with the stainless steel screws above when shipped. When an auto switch is shipped independently, BBA4 is attached.

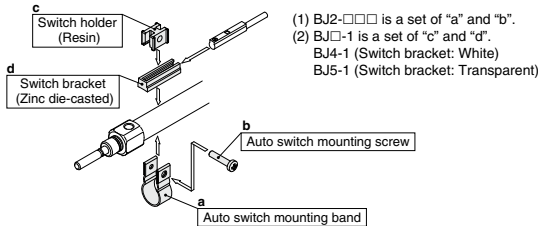

Besides the models listed in How to Order, the following auto switches are applicable. Refer to pages 1341 to 1435 for the detailed specifications.

Auto switch type	Part no.	Electrical entry (Fetching direction)	Features
Reed	D-C73, C76	Grommet (In-line)	—
	D-C80		Without indicator light
Solid state	D-H7A1, H7A2, H7B		—
	D-H7NW, H7PW, H7BW		Diagnostic indication (2-color indicator)

\* For solid state auto switches, auto switches with a pre-wired connector are also available. Refer to pages 1410 and 1411 for details.

\* Normally closed (NC = b contact) solid state auto switches (D-M9□E(V)) are also available. Refer to page 1360 for details.

# Fine Lock Cylinder

## Double Acting, Single Rod

# CLM2 Series

ø20, ø25, ø32, ø40

### How to Order

**CLM2**  **L**  **25**  - **100**  - **E**  -

**With auto switch** **CDLM2**  **L**  **25**  - **100**  - **E**  - **M9BW**  - **C**  -

**With auto switch** (Built-in magnet)

**Type**

Nil	Pneumatic
H	Air-hydro

**Port thread type**

Nil	Rc
TN	NPT

**Mounting type**

<b>B</b>	Basic type	<b>T</b>	Head side trunnion type
<b>L</b>	Axial foot type	<b>E</b>	Clevis integrated type
<b>F</b>	Rod side flange type	<b>BZ</b>	Boss-cut basic type
<b>G</b>	Head side flange type	<b>FZ</b>	Boss-cut flange type
<b>C</b>	Single clevis type		
<b>D</b>	Double clevis type		

**Bore size**

<b>20</b>	20 mm
<b>25</b>	25 mm
<b>32</b>	32 mm
<b>40</b>	40 mm

**Cylinder stroke (mm)**

Refer to "Standard Stroke" on page 976.

**With rod boot**

Nil	None
J	Nylon tarpaulin
K	Heat resistant tarpaulin

**Lock operation**

<b>E</b>	Spring locking (Exhaust locking)
<b>P</b>	Pneumatic locking (Pressure locking)
<b>D</b>	Spring and pneumatic locking

**Auto switch mounting bracket** <sup>(Note)</sup>

Note) This symbol is indicated when the D-A9□ or M9□ type auto switch is specified. This mounting bracket does not apply to other auto switches (D-C7□ and H7□, etc.) (Nil)

**Number of auto switches**

Nil	2 pcs.
S	1 pc.
n	"n" pcs.

**Auto switch**

Nil	Without auto switch
-----	---------------------

\* For the applicable auto switch model, refer to the table below.

**Made to Order**

Refer to page 976 for details.

### Built-in Magnet Cylinder Model

If a built-in magnet cylinder without an auto switch is required, there is no need to enter the symbol for the auto switch. (Example) CDLM2F32-100-P

### Applicable Auto Switches

Refer to pages 1341 to 1435 for further information on auto switches.

Type	Special function	Electrical entry	Indicator light	Wiring (Output)	Load voltage		Auto switch model		Lead wire length (m)				Pre-wired connector	Applicable load	
					DC	AC	Perpendicular	In-line	0.5 (Nil)	1 (M)	3 (L)	5 (Z)			None (N)
Solid state auto switch	—	Grommet	—	3-wire (NPN)	5 V, 12 V	—	M9NV	M9N	●	●	○	○	○	IC circuit	
				3-wire (PNP)			M9PV	M9P	●	●	○	○	—		
		Connector	Terminal conduit	2-wire	12 V	—	M9BV	M9B	●	●	●	●		○	—
				3-wire (NPN)	5 V, 12 V	—	H7C	—	●	●	●	●	IC circuit		
	Diagnostic indication (2-color indicator)	Grommet	Yes	2-wire	12 V	—	K39A	—	●	●	●	●		—	
				3-wire (NPN)	5 V, 12 V	—	M9NVV	M9NV	●	●	●	●	IC circuit		
		3-wire (PNP)	12 V	—	M9PWW	M9PW	●	●	●	●	—				
		2-wire	12 V	—	M9BWW	M9BW	●	●	●	●		—			
		Water resistant (2-color indicator)	Grommet	—	3-wire (NPN)	5 V, 12 V	—	M9NAV <sup>*1</sup>	M9NA <sup>*1</sup>	○	○		○	○	IC circuit
					3-wire (PNP)	12 V	—	M9PAV <sup>*1</sup>	M9PA <sup>*1</sup>	○	○	○	○	—	
2-wire	12 V	—	M9BAV <sup>*1</sup>	M9BA <sup>*1</sup>	○	○	○	○	—						
4-wire (NPN)	5 V, 12 V	—	H7NF	—	●	●	●	●		IC circuit					
4-wire (NPN equivalent)	5 V	—	A96V	A96	●	●	●	●	IC circuit						
Reed auto switch	—	Grommet	—	2-wire	12 V	—	A93V <sup>*2</sup>	A93		●	●	●	●	—	
							100 V or less	A90V	A90	●	●	●	●		IC circuit
		Connector	Terminal conduit	Yes	No	No	12 V	—	100 V, 200V	—	B54	●	●	●	
									200 V or less	—	B64	●	●	●	—
	Diagnostic indication (2-color indicator)	Grommet	Yes	No	No	12 V	—	24 V or less	—	C73C	●	●	●	IC circuit	
								100 V, 200 V	—	C80C	●	●	●		—
		DIN terminal	Grommet	Yes	No	No	12 V	—	—	A33A	—	●	●	—	
									—	—	A34A	—	●		●
	—	—	—	—	—	—	—	—	A44A	—	●	●	—		
								—	—	B59W	●	●		●	—

\*1 Water resistant type auto switches can be mounted on the above models, but in such case SMC cannot guarantee water resistance.

Consult with SMC regarding water resistant types with the above model numbers.

\*2 1 m type lead wire is only applicable to D-A93.

\* Lead wire length symbols: 0.5 m ..... Nil (Example) M9NV  
 1 m ..... M (Example) M9NWM  
 3 m ..... L (Example) M9NLW  
 5 m ..... Z (Example) M9NZW  
 None ..... N (Example) H7CN

\* Solid state auto switches marked with "O" are produced upon receipt of order.  
 \* Do not indicate suffix "N" for no lead wire on D-A93□/A44□/G39A/K39A models.

\* Since there are other applicable auto switches than listed above, refer to page 991 for details.

\* For details about auto switches with pre-wired connector, refer to pages 1410 and 1411.

\* D-A9□(V)/M9□(V)/M9□W(V)/M9□A(V) auto switches are shipped together (not assembled). (Only auto switch mounting brackets are assembled at the time of shipment.)

# CLM2 Series

**Provided with a compact lock mechanism, it is suitable for intermediate stop, emergency stop, and drop prevention.**

## Locking in both directions

The piston rod can be locked in either direction of its cylinder stroke.

## Maximum piston speed: 500 mm/s

It can be used at 50 to 500 mm/s provided that it is within the allowable kinetic energy range.

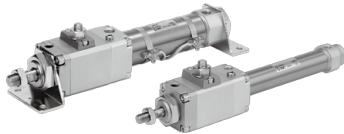

## Symbol

Rubber bumper

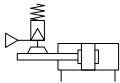

**Made to Order Specifications**  
[Click here for details](#)

Symbol	Specifications
-XA□	Change of rod end shape

## Rod Boot Material

Symbol	Rod boot material	Maximum ambient temperature
<b>J</b>	Nylon tarpaulin	70°C
<b>K</b>	Heat resistant tarpaulin	110°C*

\* Maximum ambient temperature for the rod boot itself.

Refer to pages 988 to 991 for cylinders with auto switches.

- Minimum auto switch mounting stroke
- Proper auto switch mounting position (detection at stroke end) and mounting height
- Operating range
- Switch mounting bracket: Part no.

## Specifications

Bore size (mm)	20	25	32	40
<b>Action</b>	Double acting, Single rod			
<b>Type</b>	Air cylinder			
<b>Lock operation</b>	Spring locking (Exhaust locking) Pneumatic locking (Pressurized locking), Spring and pneumatic locking			
<b>Fluid</b>	Air			
<b>Proof pressure</b>	1.5 MPa			
<b>Maximum operating pressure</b>	1.0 MPa			
<b>Minimum operating pressure</b>	0.08 MPa			
<b>Ambient and fluid temperature</b>	Without auto switch: -10 to 70°C (No freezing) With auto switch: -10 to 60°C (No freezing)			
<b>Lubrication</b>	Not required (Non-lube)			
<b>Piston speed</b>	50 to 500 mm/s *			
<b>Cushion</b>	Rubber bumper (Standard equipment)			
<b>Stroke length tolerance</b>	$\begin{matrix} +1.4 \\ 0 \end{matrix}$			
<b>Piping/Screw-in type</b>	Rc 1/8		Rc 1/4	
<b>Mounting</b>	Basic type, Axial foot type, Rod side flange type, Head side flange type, Single clevis type, Double clevis type, Head side trunnion type, Clevis integrated type, Boss-cut basic type, Boss-cut flange type			

\* Constraints associated with the allowable kinetic energy are imposed on the speeds at which the piston can be locked. The maximum speed of 750 mm/s can be accommodated if the piston is to be locked in the stationary state for the purpose of drop prevention.

## Fine Lock Specifications

Lock operation	Spring locking (Exhaust locking)	Spring and pneumatic locking	Pneumatic locking (Pressure locking)
<b>Fluid</b>	Air		
<b>Maximum operating pressure</b>	0.5 MPa		
<b>Unlocking pressure</b>	0.3 MPa or more		0.1 MPa or more
<b>Lock starting pressure</b>	0.25 MPa or less		0.05 MPa or more
<b>Locking direction</b>	Both directions		

\* Refer to page 978 for the allowable kinetic energy when locking, holding force of spring locking and stopping accuracy.

## Standard Stroke / Refer to the minimum auto switch mounting stroke (page 990) for those with an auto switch.

Bore size (mm)	Standard stroke <sup>(1)</sup> (mm)	Maximum stroke (mm)
<b>20</b>	25, 50, 75, 100, 125, 150 200, 250, 300	1000
<b>25</b>		
<b>32</b>		
<b>40</b>		

Note1) Intermediate strokes other than listed above are produced upon receipt of order. Manufacture of intermediate strokes at 1 mm intervals is possible. (Spacers are not used.)

Note 2) Applicable strokes should be confirmed according to the usage. For details, refer to the CM2 series of the "Air Cylinders Model Selection" in the **Web Catalog**. In addition, the products that exceed the standard stroke might not be able to fulfill the specifications due to the deflection etc.

### Mounting Bracket and Accessory

Accessory	Standard equipment			Option					
	Mounting nut	Rod end nut	Clevis pin	Single knuckle joint	Double knuckle joint	Clevis <sup>(4)</sup> pivot bracket	Rod boot	Pivot <sup>(6)</sup> bracket	Pivot <sup>(7)</sup> bracket pin
Mounting	● (1 pc.)	●	—	●	●	—	●	—	—
Basic type	● (1 pc.)	●	—	●	●	—	●	—	—
Axial foot type	● (2)	●	—	●	●	—	●	—	—
Rod side flange type	● (1)	●	—	●	●	—	●	—	—
Head side flange type	● (1)	●	—	●	●	—	●	—	—
Clevis integrated type	— <sup>(1)</sup>	●	—	●	●	●	●	—	—
Single clevis type	— <sup>(1)</sup>	●	—	●	●	—	●	●	●
Double clevis type <sup>(8)</sup>	— <sup>(1)</sup>	● (5)	—	●	●	—	●	—	—
Head side trunnion type	● (1) <sup>(2)</sup>	●	—	●	●	—	●	●	●
Boss-cut basic type	● (1)	●	—	●	●	—	●	—	—
Boss-cut flange type	● (1)	●	—	●	●	—	●	—	—
Note				With pin	With pin				

- Note 1) Mounting nut is not equipped with clevis integrated type, single clevis type and double clevis type.  
 Note 2) Trunnion nuts are attached for head side trunnion type.  
 Note 3) Pin and retaining ring (ø40: cotter pin) are shipped together with double clevis and double knuckle joint.  
 Note 4) Pin and retaining ring are shipped together with clevis pivot bracket.  
 Note 5) Clevis pins come with retaining rings (cotter pins for ø40).  
 Note 6) Pivot brackets do not come with pins and retaining rings.  
 Note 7) Pivot bracket pins come with retaining rings.  
 Note 8) For part numbers and dimensions of accessories (Options), refer to pages 985 to 987.

### Weight

		Bore size (mm)				(kg)
		20	25	32	40	
Basic weight	Basic type	0.55	0.87	0.94	1.30	
	Axial foot type	0.70	1.03	1.10	1.57	
	Flange type	0.61	0.96	1.03	1.42	
	Clevis integrated type	0.53	0.85	0.93	1.26	
	Single clevis type	0.59	0.91	0.98	1.39	
	Double clevis type	0.60	0.93	0.99	1.43	
	Trunnion type	0.59	0.94	1.00	1.40	
	Boss-cut basic type	0.54	0.85	0.92	1.27	
	Boss-cut flange type	0.60	0.94	1.01	1.39	
Additional weight per each 50 mm of stroke		0.04	0.06	0.08	0.13	
Option bracket	Clevis bracket (With pin)	0.07	0.07	0.14	0.14	
	Single knuckle joint	0.06	0.06	0.06	0.23	
	Double knuckle joint (With pin)	0.07	0.07	0.07	0.20	
	Pivot bracket	0.06	0.06	0.06	0.06	
	Pivot bracket pin	0.02	0.02	0.02	0.03	

Calculation: (Example) CLM2L32-100-E

- Basic weight ..... 1.10 (Foot, ø32)
- Additional weight ..... 0.08/50 stroke
- Cylinder stroke ..... 100 stroke  $1.10 + 0.08 \times 100/50 = 1.26$  kg

### Mounting Bracket Part No.

Bore size (mm)	20	25	32	40
Axial foot *	CM-L020B	CM-L032B	CM-L040B	
Flange	CM-F020B	CM-F032B	CM-F040B	
Single clevis	CM-C020B	CM-C032B	CM-C040B	
Double clevis **	CM-D020B	CM-D032B	CM-D040B	
Trunnion (with nut)	CM-T020B	CM-T032B	CM-T040B	

- \* When ordering foot bracket, order 2 pieces per cylinder.  
 \*\* Clevis pin and retaining ring (ø40: cotter pin) are shipped together with double clevis type.

### Boss-cut type

Boss for the head side cover bracket is eliminated and the total length of cylinder is shortened.



### Comparison of the full length dimension (Versus standard type)

	ø20	ø25	ø32	ø40
	▲13	▲13	▲13	▲16

### Mounting type

- Boss-cut basic type (BZ) ■ Boss-cut flange type (FZ)

### Air-hydro

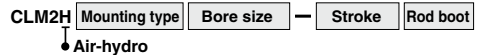

Low hydraulic cylinder 1 MPa or less

Through the concurrent use of a CC series air-hydro unit, it is possible to operate at a constant or low speeds or to effect an intermediate stop, just like a hydraulic unit, while using pneumatic equipment such as a valve.



### Specifications

Fluid	Turbine oil (Lock portion is air)
Action	Double acting, Single rod
Bore size (mm)	ø20, ø25, ø32, ø40
Maximum operating pressure	1.0 MPa
Minimum operating pressure	0.2 MPa
Piston speed	15 to 300 mm/s
Cushion	Rubber bumper (Standard equipment)
Piping	Screw-in type
Mounting	Basic type, Axial foot type, Rod side flange type Head side flange type, Single clevis type Double clevis type, Head side trunnion type Clevis integrated type, Boss-cut type

\* Auto switch capable

- For an exterior dimension diagram to identify the mounting support types, refer to pages 980 to 984 as the dimensions are identical to those of standard.

# CLM2 Series

## ⚠ Caution/Allowable Kinetic Energy when Locking

Bore size (mm)	20	25	32	40
Allowable kinetic energy (J)	0.26	0.42	0.67	1.19

- In terms of specific load conditions, the allowable kinetic energy indicated in the table above is equivalent to a 50% load ratio at 0.5 MPa, and a piston speed of 300 mm/sec. Therefore, if the operating conditions are below these values, calculations are unnecessary.
- Apply the following formula to obtain the kinetic energy of the load.
 
$$E_k = \frac{1}{2} m v^2$$
 Ek: Kinetic energy of load (J)  
 m: Load mass (kg)  
 v: Piston speed (m/s)
- The piston speed will exceed the average speed immediately before locking. To determine the piston speed for the purpose of obtaining the kinetic energy of load, use 1.2 times the average speed as a guide.
- The relation between the speed and the load of the respective tube bores is indicated in the diagram below. Use the cylinder in the range below the line.
- Even within a given allowable kinetic energy level, there is an upper limit to the size of the load that can be sustained. Thus, a horizontally mounted cylinder must be operated below the solid line, and a vertically mounted cylinder must be operated below the dotted line.

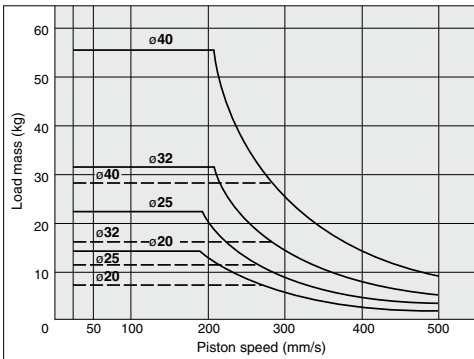

## Stopping Accuracy (Not including tolerance of control system.) (mm)

Locking method	Piston speed (mm/s)				
	20 *	50	100	300	500
Spring locking (Exhaust locking)	±0.3	±0.4	±0.5	±1.0	±2.0
Pneumatic locking (Pressure locking)	±0.15	±0.2	±0.3	±0.5	±1.5
Spring and pneumatic locking	±0.15	±0.2	±0.3	±0.5	±1.5

Conditions: Load: 25% of thrust force at 0.5 MPa

Solenoid valve: Mounted to the lock port

20 mm/s marked with the asterisk is in the case of actuating hydraulically by means of air-hydraulic type.

## ⚠ Caution

### Selection/Recommended Pneumatic Circuit/Caution on Handling

For detailed specifications of the fine lock cylinder, CLM2 series mentioned above, refer to pages 1004 to 1007.

## Holding Force of Spring Locking (Maximum static load)

Bore size (mm)	20	25	32	40
Holding force (N)	196	313	443	784

Note) Holding force at piston rod extended side decreases approximately 15%.

## Holding Force of Spring Locking (Maximum static load)

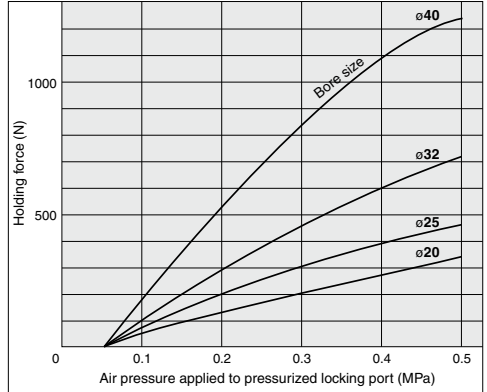

\* When selecting cylinders, refer to the Precautions and allowable kinetic energy when locking on page 1004, and then select a cylinder.

## ⚠ Caution

### Caution when Locking

Holding force (maximum static load) means the maximum capability of holding a static load that is not accompanied by vibration or impact under the condition that no load is applied. Therefore, it does not refer to a load that cannot be held constantly. When using (selecting) this product, carefully check the following points.

- If the piston rod slips because the lock's holding force has been exceeded, the brake shoe could be damaged, resulting in a reduced holding force or shortened life.
- Do not use the cylinder in the locked state to sustain a load that involves impact.
- The upper limit of the load that is used under the conditions not associated with the kinetic energy when locking, such as drop prevention must be 35% or less of the holding force.

## ⚠ Caution

### Operating Precautions

- Install a rod boot without twisting. If the cylinder is installed with its bellows twisted, it could damage the bellows.



**Construction (Not able to disassemble)**

**Spring locking (Exhaust locking)  
Spring and pneumatic locking**

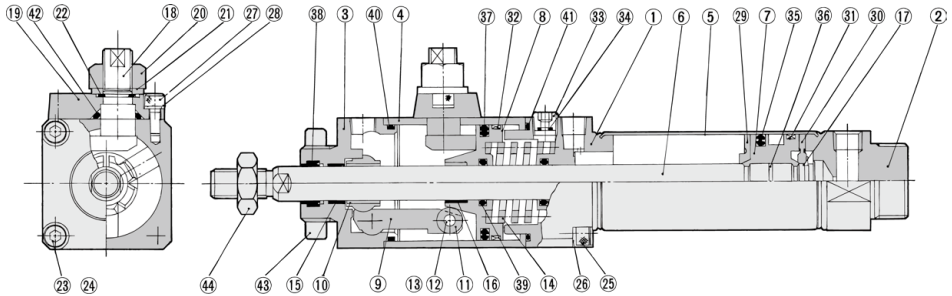

**Pneumatic locking (Pressure locking)**

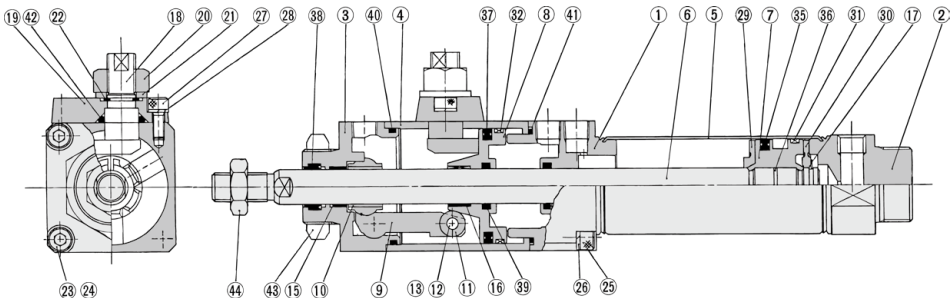

**Component Parts**

No.	Description	Material	Note
1	Rod cover	Aluminum alloy	Clear anodized
2	Head cover	Aluminum alloy	Clear anodized
3	Cover	Carbon steel	Nitrided, chrome plated
4	Intermediate cover	Aluminum alloy	Hard anodized
5	Cylinder tube	Stainless steel	
6	Piston rod	Carbon steel	Hard chrome plated
7	Piston	Aluminum alloy	Chromated
8	Brake piston	Carbon steel	Nitrided
9	Brake arm	Carbon steel	Nitrided
10	Brake shoe	Special friction material	
11	Roller	Carbon steel	
12	Pin	Carbon steel	
13	Retaining ring	Carbon tool steel	
14	Brake spring	Spring steel wire	Anti-corrosive treatment
15	Bushing	Bearing alloy	
16	Bushing	Bearing alloy	
17	Retaining ring	Stainless steel	
18	Manual lock release cam	Chromium molybdenum steel	Nickel plated
19	Cam guide	Carbon steel	Nitrided, painted
20	Lock nut	Rolled steel	
21	Flat washer	Rolled steel	
22	Retaining ring	Carbon tool steel	
23	Hexagon socket head cap screw	Chromium molybdenum steel	

No.	Description	Material	Note
24	Spring washer	Steel wire	
25	Hexagon socket head cap screw	Chromium molybdenum steel	
26	Spring washer	Steel wire	
27	Hexagon socket head cap screw	Chromium molybdenum steel	
28	Spring washer	Steel wire	
29	Bumper A	Urethane	
30	Bumper B	Urethane	
31	Wear ring	Resin	
32	Wear ring	Resin	
33	Hexagon socket head plug	Carbon steel	Type E only
34	Element	Bronze	Type E only
35	Piston seal	NBR	
36	Piston gasket	NBR	
37	Brake piston seal	NBR	
38	Rod seal A	NBR	
39	Rod seal B	NBR	
40	Middle cover gasket A	NBR	
41	Middle cover gasket B	NBR	
42	Cam gasket	NBR	
43	Mounting nut	Carbon steel	
44	Rod end nut	Carbon steel	

# CLM2 Series

## Basic Type (B)

CLM2B

### Standard type

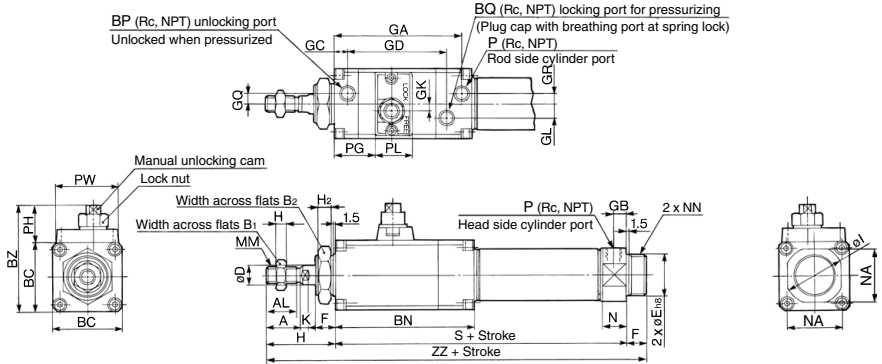

### Boss-cut type

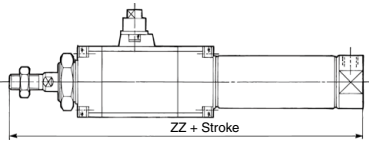

### With rod boot

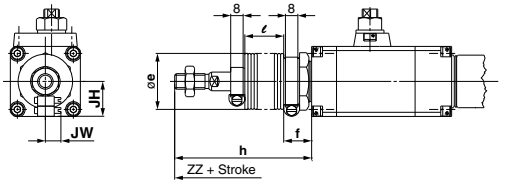

Bore (mm)	Stroke range	A	AL	B <sub>1</sub>	B <sub>2</sub>	BC	BN	BP	BQ	BZ	D	E	F	GA	GB	GC	GD	GK	GL	GQ	GR	H	H <sub>1</sub>	H <sub>2</sub>	I		
20	Up to 300	18	15.5	13	26	38	80	1/8	1/8	57.5	8	20 <sup>0</sup> <sub>-0.033</sub>	13	73.5	8	8	55	3.5	6	4	4	4	4	1	5	8	28
25	Up to 300	22	19.5	17	32	45	90	1/8	1/8	69	10	26 <sup>0</sup> <sub>-0.033</sub>	13	83.5	8	9	64.5	4	9	7	7	4	5	6	8	33.5	
32	Up to 300	22	19.5	17	32	45	90	1/8	1/8	69	12	26 <sup>0</sup> <sub>-0.033</sub>	13	83.5	8	9	64.5	4	9	7	7	4	5	6	8	37.5	
40	Up to 300	24	21	22	41	52	100.5	1/8	1/8	76	14	32 <sup>0</sup> <sub>-0.039</sub>	16	90.5	11	8	70	4	11	8	7	5	8	10	46.5		

Bore (mm)	K	MM	N	NA	NN	P	PG	PH	PL	PW	S	ZZ
20	5	M8 x 1.25	15	24	M20 x 1.5	1/8	22	19.5	20	38	127	181
25	5.5	M10 x 1.25	15	30	M26 x 1.5	1/8	27	24	24	41	137	195
32	5.5	M10 x 1.25	15	34.5	M26 x 1.5	1/8	27	24	24	41	139	197
40	7	M14 x 1.5	21.5	42.5	M32 x 2	1/4	29	24	24	41	167	233

### Boss-cut

Bore (mm)	ZZ
20	168
25	182
32	184
40	217

### With Rod Boot

Bore (mm)	e	f	h						ℓ						ZZ						JH (Reference)	JW (Reference)
			1 to 50	51 to 100	101 to 150	151 to 200	201 to 300	1 to 50	51 to 100	101 to 150	151 to 200	201 to 300	1 to 50	51 to 100	101 to 150	151 to 200	201 to 300					
20	36	17	68	81	93	106	131	12.5	25	37.5	50	75	208	221	233	246	271	23.5	10.5			
25	36	17	72	85	97	110	135	12.5	25	37.5	50	75	222	232	247	260	285	23.5	10.5			
32	36	17	72	85	97	110	135	12.5	25	37.5	50	75	224	237	249	262	287	23.5	10.5			
40	46	19	77	90	102	115	140	12.5	25	37.5	50	75	260	273	285	298	323	23.5	10.5			

# Fine Lock Cylinder Double Acting, Single Rod **CLM2 Series**

## Axial Foot Type (L)

CLM2L  —

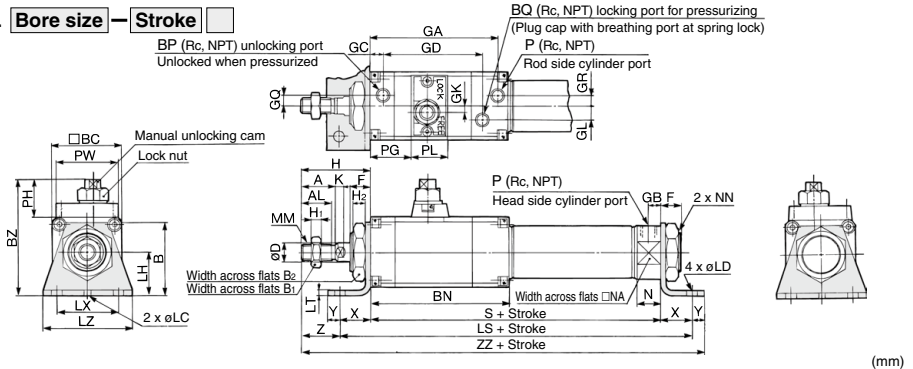

Bore (mm)	Stroke range	A	AL	B	B <sub>1</sub>	B <sub>2</sub>	BC	BN	BP	BQ	BZ	D	F	GA	GB	GC	GD	GK	GL	GQ	GR	H	H <sub>1</sub>	H <sub>2</sub>
20	Up to 400	18	15.5	40	13	26	38	80	1/8	1/8	63.5	8	13	73.5	8	8	64.5	3.5	6	4	4	41	5	8
25	Up to 450	22	19.5	47	17	32	45	90	1/8	1/8	74.5	10	13	83.5	8	9	64.5	4	9	7	7	45	6	8
32	Up to 450	22	19.5	47	17	32	45	90	1/8	1/8	74.5	12	13	83.5	8	9	64.5	4	9	7	7	45	6	8
40	Up to 500	24	21	54	22	41	52	100.5	1/8	1/8	80	14	16	90.5	11	8	70	4	11	8	7	50	8	10

Bore (mm)	K	LC	LD	LH	LS	LT	LX	LZ	MM	N	NA	NN	P	PG	PH	PL	PW	S	X	Y	Z	ZZ
20	5	4	6.8	25	167	3.2	40	55	M8 x 1.25	15	24	M20 x 1.5	1/8	22	19.5	20	38	127	20	8	21	196
25	5.5	4	6.8	28	177	3.2	40	55	M10 x 1.25	15	30	M26 x 1.5	1/8	27	24	24	41	137	20	8	25	210
32	5.5	4	6.8	28	179	3.2	40	55	M10 x 1.25	15	34.5	M26 x 1.5	1/8	27	24	24	41	139	20	8	25	212
40	7	4	7	30	213	3.2	55	75	M14 x 1.5	21.5	42.5	M32 x 2	1/4	29	24	24	41	167	23	10	27	250

## Head Side Flange Type (G)

CLM2G  —

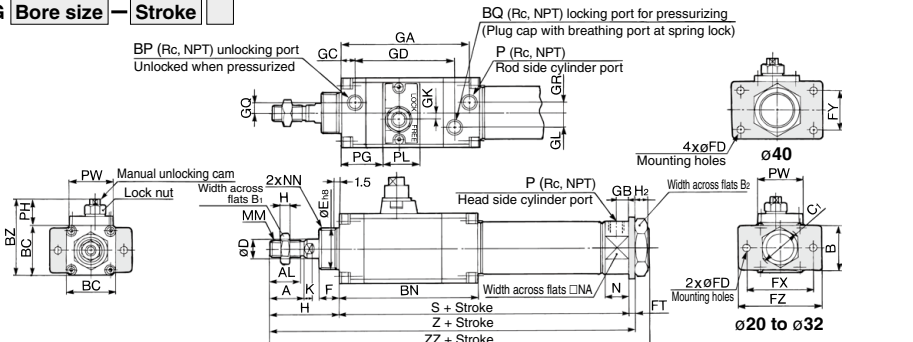

Bore (mm)	Stroke range	A	AL	B	B <sub>1</sub>	B <sub>2</sub>	BC	BN	BP	BQ	BZ	C <sub>1</sub>	D	E	F	FD	FT	FX	FY	FZ	GA	GB
20	Up to 300	18	15.5	34	13	26	38	80	1/8	1/8	57.5	30	8	20 <sup>0</sup> <sub>-0.033</sub>	13	7	4	60	—	75	73.5	8
25	Up to 300	22	19.5	40	17	32	45	90	1/8	1/8	69	37	10	26 <sup>0</sup> <sub>-0.033</sub>	13	7	4	60	—	75	83.5	8
32	Up to 300	22	19.5	40	17	32	45	90	1/8	1/8	69	37	12	26 <sup>0</sup> <sub>-0.033</sub>	13	7	4	60	—	75	83.5	8
40	Up to 300	24	21	52	22	41	52	100.5	1/8	1/8	76	47.3	14	32 <sup>0</sup> <sub>-0.039</sub>	16	7	5	66	36	82	90.5	11

Bore (mm)	GC	GD	GK	GL	GQ	GR	H	H <sub>1</sub>	H <sub>2</sub>	K	MM	N	NA	NN	P	PG	PH	PL	PW	S	Z	ZZ
20	8	55	3.5	6	4	4	41	5	8	5	M8 x 1.25	15	24	M20 x 1.5	1/8	22	19.5	20	38	127	172	181
25	9	64.5	4	9	7	7	45	6	8	5.5	M10 x 1.25	15	30	M26 x 1.5	1/8	27	24	24	41	137	186	195
32	9	64.5	4	9	7	7	45	6	8	5.5	M10 x 1.25	15	34.5	M26 x 1.5	1/8	27	24	24	41	139	188	197
40	8	70	4	11	8	7	50	8	10	7	M14 x 1.5	21.5	42.5	M32 x 2	1/4	29	24	24	41	167	222	233

# CLM2 Series

## Rod Side Flange Type (F)

CLM2F

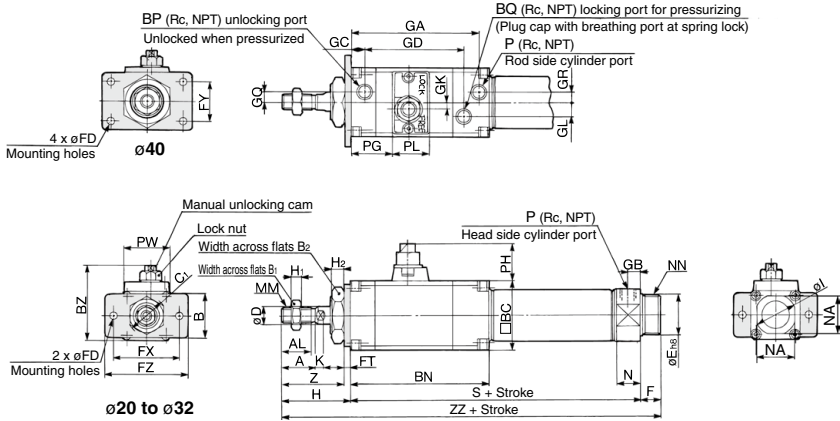

### Boss-cut type

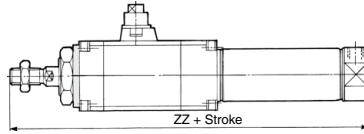

		(mm)																							
Bore (mm)	Stroke range	A	AL	B	B1	B2	BC	BN	BP	BQ	BZ	C1	D	E	F	FD	FT	FX	FY	FZ	GA	GB	GC	GD	GK
20	Up to 400	18	15.5	34	13	26	38	80	1/8	1/8	57.5	30	8	20 <sup>0</sup> <sub>-0.033</sub>	13	7	4	60	—	75	73.5	8	8	55	3.5
25	Up to 450	22	19.5	40	17	32	45	90	1/8	1/8	69	37	10	26 <sup>0</sup> <sub>-0.033</sub>	13	7	4	60	—	75	83.5	8	9	64.5	4
32	Up to 450	22	19.5	40	17	32	45	90	1/8	1/8	69	37	12	26 <sup>0</sup> <sub>-0.033</sub>	13	7	4	60	—	75	83.5	8	9	64.5	4
40	Up to 500	24	21	52	22	41	52	100.5	1/8	1/8	76	47.3	14	32 <sup>0</sup> <sub>-0.039</sub>	16	7	5	66	36	82	90.5	11	8	70	4

		(mm)																		<b>Boss-cut</b>			
Bore (mm)		GL	GQ	GR	H	H1	H2	I	K	MM	N	NA	NN	P	PG	PH	PL	PW	S	Z	ZZ	Bore (mm)	ZZ
20		6	4	4	41	5	8	28	5	M8 x 1.25	15	24	M20 x 1.5	1/8	22	19.5	20	38	127	37	181	20	168
25		9	7	7	45	6	8	33.5	5.5	M10 x 1.25	15	30	M26 x 1.5	1/8	27	24	24	41	137	41	195	25	182
32		9	7	7	45	6	8	37.5	5.5	M10 x 1.25	15	34.5	M26 x 1.5	1/8	27	24	24	41	139	41	197	32	184
40		11	8	7	50	8	10	46.5	7	M14 x 1.5	21.5	42.5	M32 x 2	1/4	29	24	24	41	167	45	233	40	217

# Fine Lock Cylinder Double Acting, Single Rod **CLM2 Series**

## Single Clevis Type (C)

**CLM2C**  —

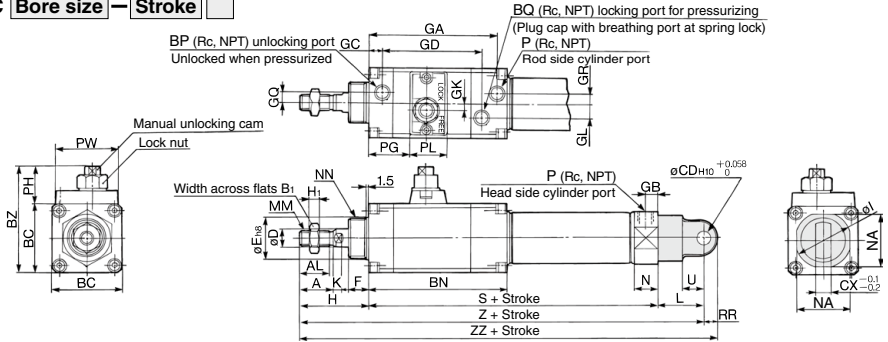

Bore (mm)	Stroke range	A	AL	B <sub>1</sub>	BC	BN	BP	BQ	BZ	CD	CX	D	E	F	GA	GB	GC	GD	GK	GL	QQ
20	Up to 300	18	15.5	13	38	80	1/8	1/8	57.5	9	10	8	20 <sup>0</sup> <sub>-0.033</sub>	13	73.5	8	8	55	3.5	6	4
25	Up to 300	22	19.5	17	45	90	1/8	1/8	69	9	10	10	26 <sup>0</sup> <sub>-0.033</sub>	13	83.5	8	9	64.5	4	9	7
32	Up to 300	22	19.5	17	45	90	1/8	1/8	69	9	10	12	26 <sup>0</sup> <sub>-0.033</sub>	13	83.5	8	9	64.5	4	9	7
40	Up to 300	24	21	22	52	100.5	1/8	1/8	76	10	15	14	32 <sup>0</sup> <sub>-0.039</sub>	16	90.5	11	8	70	4	11	8

Bore (mm)	GR	H	H <sub>1</sub>	I	K	L	MM	N	NA	NN	P	PG	PH	PL	PW	RR	S	U	Z	ZZ
20	4	41	5	28	5	30	M8 x 1.25	15	24	M20 x 1.5	1/8	22	19.5	20	38	9	127	14	198	207
25	7	45	6	33.5	5.5	30	M10 x 1.25	15	30	M26 x 1.5	1/8	27	24	24	41	9	137	14	212	221
32	7	45	6	37.5	5.5	30	M10 x 1.25	15	34.5	M26 x 1.5	1/8	27	24	24	41	9	139	14	214	223
40	7	50	8	46.5	7	39	M14 x 1.5	21.5	42.5	M32 x 2	1/4	29	24	24	41	11	167	18	256	267

## Double Clevis Type (D)

**CLM2D**  —

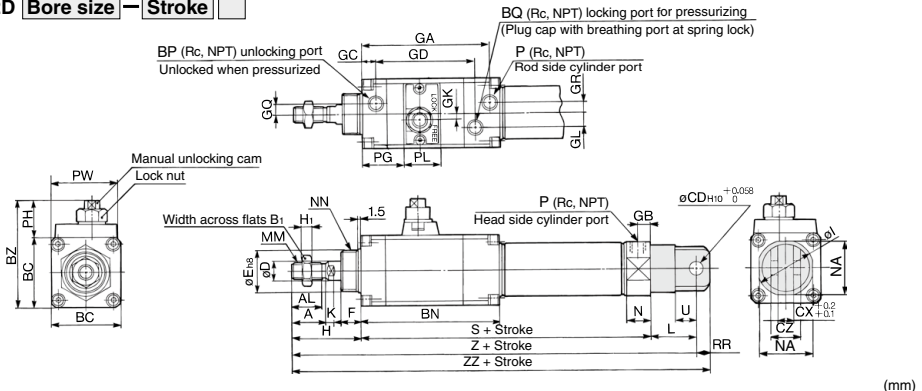

Bore (mm)	Stroke range	A	AL	B <sub>1</sub>	BC	BN	BP	BQ	BZ	CD	CX	CZ	D	E	F	GA	GB	GC	GD	GK	GL
20	Up to 300	18	15.5	13	38	80	1/8	1/8	57.5	9	10	19	8	20 <sup>0</sup> <sub>-0.033</sub>	13	73.5	8	8	55	3.5	6
25	Up to 300	22	19.5	17	45	90	1/8	1/8	69	9	10	19	10	26 <sup>0</sup> <sub>-0.033</sub>	13	83.5	8	9	64.5	4	9
32	Up to 300	22	19.5	17	45	90	1/8	1/8	69	9	10	19	12	26 <sup>0</sup> <sub>-0.033</sub>	13	83.5	8	9	64.5	4	9
40	Up to 300	24	21	22	52	100.5	1/8	1/8	76	10	15	30	14	32 <sup>0</sup> <sub>-0.039</sub>	16	90.5	11	8	70	4	11

Bore (mm)	GQ	GR	H	H <sub>1</sub>	I	K	L	MM	N	NA	NN	P	PG	PH	PL	PW	RR	S	U	Z	ZZ
20	4	4	41	5	28	5	30	M8 x 1.25	15	24	M20 x 1.5	1/8	22	19.5	20	38	9	127	14	198	207
25	7	7	45	6	33.5	5.5	30	M10 x 1.25	15	30	M26 x 1.5	1/8	27	24	24	41	9	137	14	212	221
32	7	7	45	6	37.5	5.5	30	M10 x 1.25	15	34.5	M26 x 1.5	1/8	27	24	24	41	9	139	14	214	223
40	8	7	50	8	46.5	7	39	M14 x 1.5	21.5	42.5	M32 x 2	1/4	29	24	24	41	11	167	18	256	267

\* Clevis pin and snap ring (ø40: cotter pin) are shipped together.

# CLM2 Series

## Head Side Trunnion Type (T)

CLM2T  Bore size —  Stroke

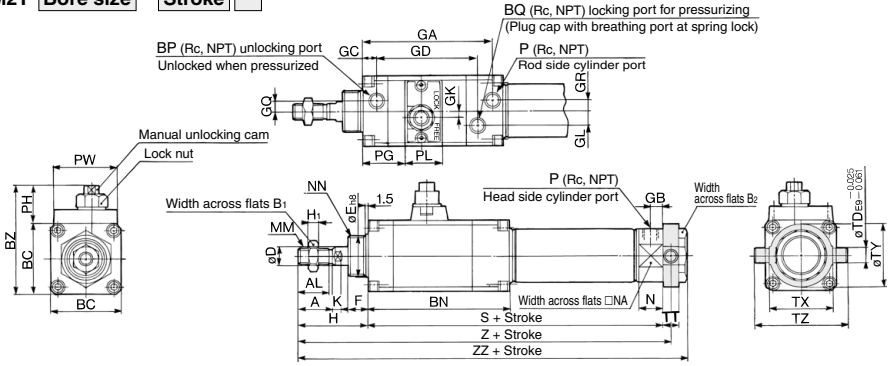

Bore (mm)	Stroke range	A	AL	B <sub>1</sub>	B <sub>2</sub>	BC	BN	BP	BQ	BZ	D	E	F	GA	GB	GC	GD	GK	GL	GQ
20	Up to 300	18	15.5	13	26	38	80	1/8	1/8	57.5	8	20 <sup>0</sup> <sub>-0.033</sub>	13	73.5	8	8	55	3.5	6	4
25	Up to 300	22	19.5	17	32	45	90	1/8	1/8	69	10	26 <sup>0</sup> <sub>-0.033</sub>	13	83.5	8	9	64.5	4	9	7
32	Up to 300	22	19.5	17	32	45	90	1/8	1/8	69	12	26 <sup>0</sup> <sub>-0.033</sub>	13	83.5	8	9	64.5	4	9	7
40	Up to 300	24	21	22	41	52	100.5	1/8	1/8	76	14	32 <sup>0</sup> <sub>-0.039</sub>	16	90.5	11	8	70	4	11	8

Bore (mm)	GR	H	H <sub>1</sub>	K	MM	N	NA	NN	P	PG	PH	PL	PW	S	TD	TT	TX	TY	TZ	Z	ZZ
20	4	41	5	5	M8 x 1.25	15	24	M20 x 1.5	1/8	22	19.5	20	38	127	8	10	32	32	52	173	183
25	7	45	6	5.5	M10 x 1.25	15	30	M26 x 1.5	1/8	27	24	24	41	137	9	10	40	40	60	187	197
32	7	45	6	5.5	M10 x 1.25	15	34.5	M26 x 1.5	1/8	27	24	24	41	139	9	10	40	40	60	189	199
40	7	50	8	7	M14 x 1.5	21.5	42.5	M32 x 2	1/4	29	24	24	41	167	10	11	53	53	77	222.5	233

## Clevis Integrated Type (E)

CLM2E  Bore size —  Stroke

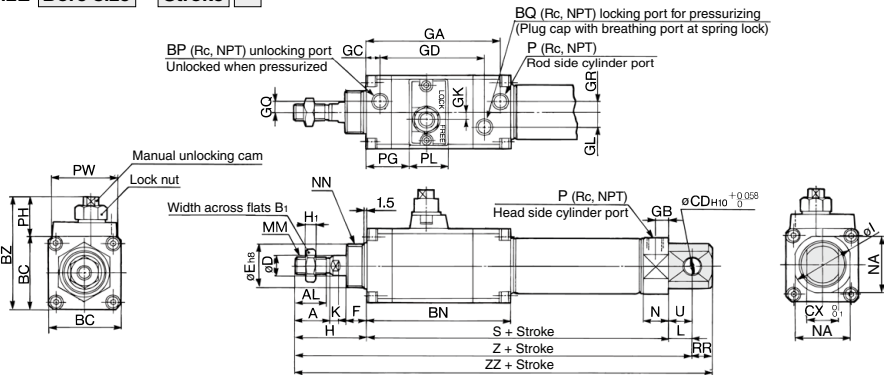

Bore (mm)	Stroke range	A	AL	B <sub>1</sub>	BC	BN	BP	BQ	BZ	CD	CX	D	E	F	GA	GB	GC	GD	GK	GL	GQ
20	Up to 300	18	15.5	13	38	80	1/8	1/8	57.5	8	12	8	20 <sup>0</sup> <sub>-0.033</sub>	13	73.5	8	8	55	3.5	6	4
25	Up to 300	22	19.5	17	45	90	1/8	1/8	69	8	12	10	26 <sup>0</sup> <sub>-0.033</sub>	13	83.5	8	9	64.5	4	9	7
32	Up to 300	22	19.5	17	45	90	1/8	1/8	69	10	20	12	26 <sup>0</sup> <sub>-0.033</sub>	13	83.5	8	9	64.5	4	9	7
40	Up to 300	24	21	22	52	100.5	1/8	1/8	76	10	20	14	32 <sup>0</sup> <sub>-0.039</sub>	16	90.5	11	8	70	4	11	8

Bore (mm)	GR	H	H <sub>1</sub>	I	K	L	MM	N	NA	NN	P	PG	PH	PL	PW	RR	S	U	Z	ZZ
20	4	41	5	28	5	12	M8 x 1.25	15	24	M20 x 1.5	1/8	22	19.5	20	38	9	127	11.5	180	189
25	7	45	6	33.5	5.5	12	M10 x 1.25	15	30	M26 x 1.5	1/8	27	24	24	41	9	137	11.5	194	203
32	7	45	6	37.5	5.5	15	M10 x 1.25	15	34.5	M26 x 1.5	1/8	27	24	24	41	12	139	14.5	199	211
40	7	50	8	46.5	7	15	M14 x 1.5	21.5	42.5	M32 x 2	1/4	29	24	24	41	12	167	14.5	232	244

# Accessory Bracket Dimensions 1

## Single Knuckle Joint

(mm)

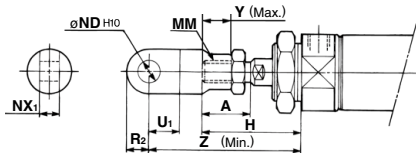

Bore size	A	H	MM	ND <sub>H10</sub>	NX <sub>1</sub>	U <sub>1</sub>	R <sub>2</sub>	Y	Z
20	18	41	M8 x 1.25	9 <sup>+0.058</sup> <sub>0</sub>	9 <sup>-0.1</sup> <sub>-0.2</sub>	14	10	11	66
25, 32	22	45	M10 x 1.25	9 <sup>+0.058</sup> <sub>0</sub>	9 <sup>-0.1</sup> <sub>-0.2</sub>	14	10	14	69
40	24	50	M14 x 1.5	12 <sup>+0.070</sup> <sub>0</sub>	16 <sup>-0.1</sup> <sub>-0.3</sub>	20	14	13	92

## Double Knuckle Joint

(mm)

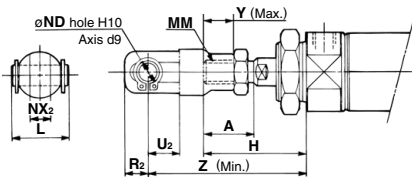

Bore size	A	H	L	MM	ND	NX <sub>2</sub>	R <sub>2</sub>	U <sub>2</sub>	Y	Z
20	18	41	25	M8 x 1.25	9	9 <sup>+0.2</sup> <sub>-0.1</sub>	10	14	11	66
25, 32	22	45	25	M10 x 1.25	9	9 <sup>+0.2</sup> <sub>-0.1</sub>	10	14	14	69
40	24	50	49.7	M14 x 1.5	12	16 <sup>+0.3</sup> <sub>-0.1</sub>	13	25	13	92

## Double Knuckle Joint

(mm)

### Y-020B/Y-032B

Material: Rolled steel

### Y-040B

Material: Cast iron

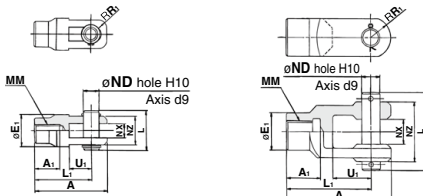

Part no.	Applicable bore size	A	A <sub>1</sub>	E <sub>1</sub>	L	L <sub>1</sub>	MM	ND	NX	NZ	R <sub>1</sub>	U <sub>1</sub>	Applicable pin part number	Retaining ring Cotter pin size
Y-020B	20	46	16	20	25	36	M8 x 1.25	9	9 <sup>+0.2</sup> <sub>-0.1</sub>	18	5	14	CDP-1	Type C9 for axis
Y-032B	25, 32	48	18	20	25	38	M10 x 1.25	9	9 <sup>+0.2</sup> <sub>-0.1</sub>	18	5	14	CDP-1	Type C9 for axis
Y-040B	40	68	22	24	49.7	55	M14 x 1.5	12	16 <sup>+0.3</sup> <sub>-0.1</sub>	38	13	25	CDP-3	ø3 x 18 ℓ

\* Clevis pin and retaining ring (cotter pin for 40) are attached.

## Double Clevis Pin/Material: Carbon steel

(mm)

### Bore size/ø20, ø25, ø32

#### CDP-1

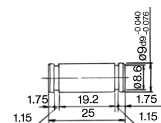

Retaining ring: Type C9 for axis

### Bore size/ø40

#### CDP-2

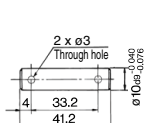

Cotter pin  
ø3 x 18 ℓ

\* Retaining rings (cotter pins for ø40) are attached.

## Single Knuckle Joint

(mm)

### I-020B/032B

Material: Rolled steel

### I-040B

Material: Free cutting sulfur steel

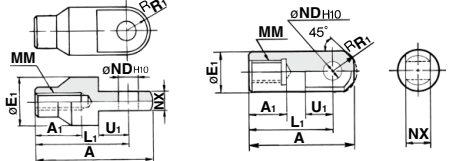

Part no.	Applicable bore size	A	A <sub>1</sub>	E <sub>1</sub>	L <sub>1</sub>	MM	ND <sub>H10</sub>	NX	R <sub>1</sub>	U <sub>1</sub>
I-020B	20	46	16	20	36	M8 x 1.25	9 <sup>+0.058</sup> <sub>0</sub>	9 <sup>-0.1</sup> <sub>-0.2</sub>	10	14
I-032B	25, 32	48	18	20	38	M10 x 1.25	9 <sup>+0.058</sup> <sub>0</sub>	9 <sup>-0.1</sup> <sub>-0.2</sub>	10	14
I-040B	40	69	22	24	55	M14 x 1.5	12 <sup>+0.070</sup> <sub>0</sub>	16 <sup>-0.1</sup> <sub>-0.3</sub>	15.5	20

## Double Knuckle Pin/Material: Carbon steel

(mm)

### Bore size/ø20, ø25, ø32

#### CDP-1

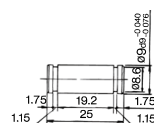

Retaining ring: Type C9 for axis

### Bore size/ø40

#### CDP-3

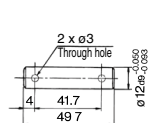

Cotter pin  
ø3 x 18 ℓ

\* Retaining rings (cotter pins for ø40) are attached.

# Accessory Bracket Dimensions 2

## Rod End Nut (mm)

Material: Carbon steel

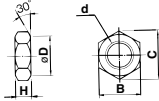

Part no.	Applicable bore size	B	C	D	d	H
NT-02	20	13	15.0	12.5	M8 x 1.25	5
NT-03	25, 32	17	19.6	16.5	M10 x 1.25	6
NT-04	40	22	25.4	21.0	M14 x 1.5	8

## Mounting Nut (mm)

Material: Carbon steel

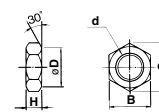

Part no.	Applicable bore size	B	C	D	d	H
SN-020B	20	26	30	25.5	M20 x 1.5	8
SN-032B	25, 32	32	37	31.5	M26 x 1.5	8
SN-040B	40	41	47.3	40.5	M32 x 2.0	10

## Trunnion Nut (mm)

Material: Carbon steel

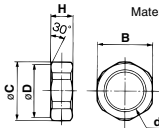

Part no.	Applicable bore size	B	C	D	d	H
TN-020B	20	26	28	25.5	M20 x 1.5	10
TN-032B	25, 32	32	34	31.5	M26 x 1.5	10
TN-040B	40	41	45	40.5	M32 x 2	10

## Clevis Pivot Bracket (For CLM2E) (mm)

Material: Rolled steel plate

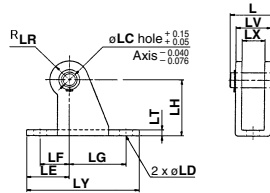

Part no.	Applicable bore size	L	LC	LD	LE	LF	LG	LH	LR	LT	LX	LY	LV	Applicable pin part no.
CM-E020B	20, 25	24.5	8	6.8	22	15	30	30	10	3.2	12	59	18.4	CD-S02
CM-E032B	32, 40	34	10	9	25	15	40	40	13	4	20	75	28	CD-S03

Note 1) Clevis pins and retaining rings (cotter pins for ø40) are attached.  
 Note 2) It cannot be used for single clevis type (CM2C) and double clevis type (CM2D).

## Clevis Pin (For CLM2E) (mm)

Material: Carbon steel

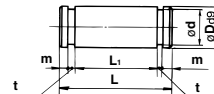

Part no.	Applicable bore size	D <sub>øS</sub>	d	L	L <sub>1</sub>	m	t	Applicable retaining ring part no.
CD-S02	20, 25	8 <sup>+0.040</sup> <sub>-0.076</sub>	7.6	24.5	19.5	1.6	0.9	Type C 8 for axis
CD-S03	32, 40	10 <sup>+0.040</sup> <sub>-0.076</sub>	9.6	34	29	1.35	1.15	Type C 10 for axis

Note) Retaining rings are attached.

Regarding mounting bracket, accessory made of stainless steel (Some are not available.), refer to page 1512 for -XB12, External stainless steel cylinder.



### Single Clevis

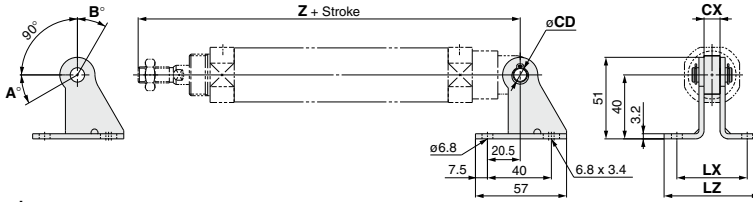

#### Rotation Angle

Bore size (mm)	A°	B°	A° + B° + 90°
20	25	85	200
25, 32	21	81	192
40	26	86	202

Mounting	Part no.	Applicable bore size	CX	Z + Stroke	CD	LX	LZ
CLM2C (Single clevis type)	CM-B032	20	10	198	9	44	60
		25		212			
		32		214			
	CM-B040	40	15	256	10	49	65

Note) Pivot brackets do not come with pivot bracket pins and retaining rings.

### Head Side Trunnion

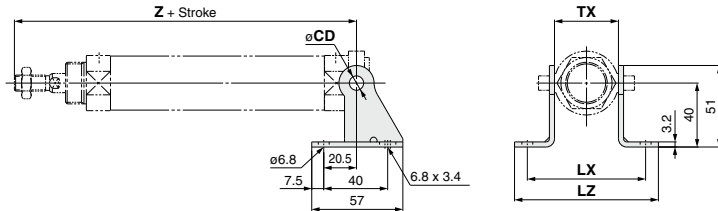

Mounting	Part no.	Applicable bore size	TX	Head side trunnion	CD	LX	LZ
				Z + Stroke			
CLM2T (Head side trunnion)	CM-B020	20	32	173	8	66	82
	CM-B032	25	40	187	9	74	90
		32		189			
	CM-B040	40	53	222.5	10	87	103

Note) Pivot brackets do not come with pivot bracket pins and retaining rings.

### Pivot Bracket

\* 2 brackets per set

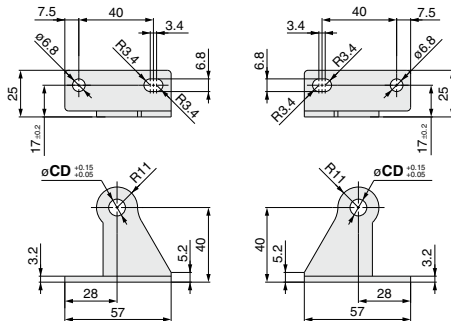

Part no.	CD
CM-B020 (2)	8
CM-B032	9
CM-B040	10

Note 1) Pivot brackets do not come with pivot bracket pins and retaining rings.  
Note 2) Only for trunnion type

### Pivot Bracket Pin (For CM2C)

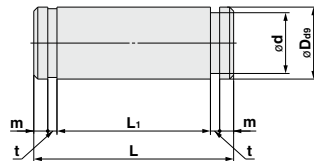

Applicable bore size	Part no.	D <sub>99</sub>	d	L	L <sub>1</sub>	m	t	Applicable retaining ring part no.
20 to 32	CDP-1	9 <sup>+0.040</sup> <sub>-0.076</sub>	8.6	25	19.2	1.75	1.15	Type C 9 for axis
40	CD-S03	10 <sup>+0.040</sup> <sub>-0.076</sub>	9.6	34	29	1.75	1.15	Type C 10 for axis

Note) Pivot bracket pins come with retaining rings.

# Auto Switch Mounting 1

## Auto Switch Proper Mounting Position (Detection at Stroke End) and Its Mounting Height

### Reed auto switch

#### D-A9□

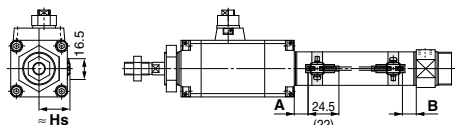

( ) : For D-A96

#### D-C7/C8

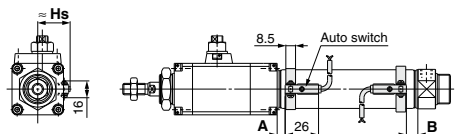

#### D-B5/B6/B59W

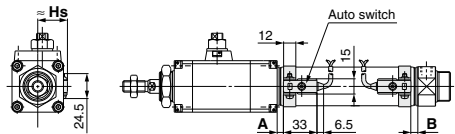

#### D-A33A/A34A

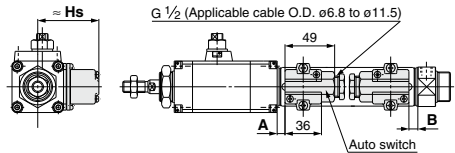

#### D-A44A

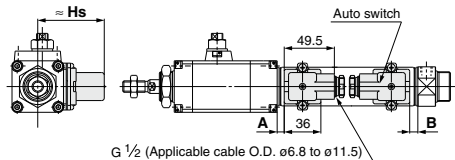

#### D-C73C/C80C

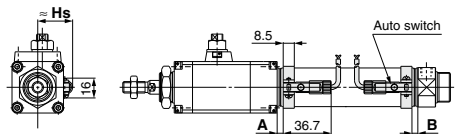

### Solid state auto switch

#### D-M9□ D-M9□A D-M9□W

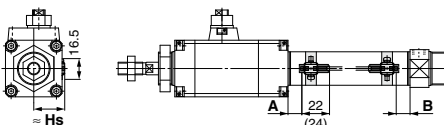

( ) : For D-M9□A

#### D-H7□/H7□W/H7NF/H7BA

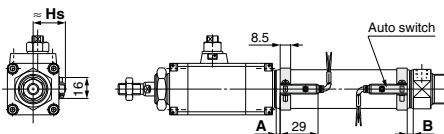

#### D-G5NTL

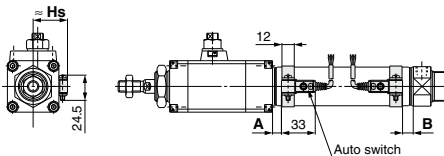

#### D-G39A/K39A

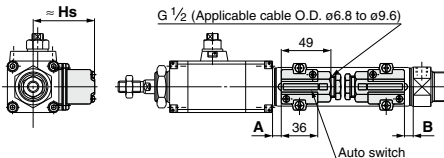

#### D-H7C

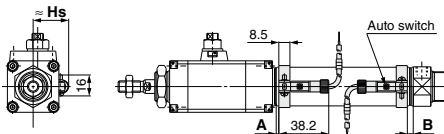

**Auto Switch Proper Mounting Position (Detection at Stroke End) and Its Mounting Height**

**Auto Switch Proper Mounting Position**

(mm)

Auto switch model	D-M9□(V) D-M9□W(V) D-M9□A(V)		D-A9□(V)		D-C7/C8 D-C73C D-C80C		D-B5 D-B6		D-B59W		D-A3□A D-G39A D-K39A D-A44A		D-H7□ D-H7C D-H7□W D-H7BA D-H7NF		D-G5NT	
	A	B	A	B	A	B	A	B	A	B	A	B	A	B	A	B
<b>20</b>	10.5	9.5	6.5	5.5	7	6	1	0	4	3	0.5	0	6	5	2.5	1.5
<b>25</b>	10.5	9.5	6.5	5.5	7	6	1	0	4	3	0.5	0	6	5	2.5	1.5
<b>32</b>	11.5	10.5	7.5	6.5	8	7	2	1	5	4	1.5	0.5	7	6	3.5	2.5
<b>40</b>	17.5	15.5	13.5	11.5	13	12	7	6	10	9	6.5	5.5	12	11	8.5	7.5

Note) Adjust the auto switch after confirming the operating conditions in the actual setting.

**Auto Switch Mounting Height**

(mm)

Auto switch model	D-M9□(V) D-M9□W(V) D-M9□A(V) D-A9□(V)		D-C7/C8 D-H7□ D-H7□W D-H7NF D-H7BA		D-B5□ D-B64 D-B59W D-G5NT D-H7C		D-C73C D-C80C		D-A3□A D-G39A D-K39A		D-A44A	
	Hs	Hs	Hs	Hs	Hs	Hs	Hs	Hs	Hs	Hs	Hs	
<b>20</b>	23	22.5	25.5	25	60	69.5						
<b>25</b>	25.5	25	28	27.5	62.5	72						
<b>32</b>	29	28.5	31.5	31	66	75.5						
<b>40</b>	33	32.5	35.5	35	70	79.5						

# Auto Switch Mounting 2

## Minimum Auto Switch Mounting Stroke

Auto switch model	No. of auto switches mounted				
	1	2		n	
		Different surfaces	Same surface	Different surfaces	Same surface
D-M9□	5	20	55	$20 + 35 \frac{(n-2)}{2}$ (n = 2, 4, 6...) <sup>Note 3)</sup>	$55 + 35 (n-2)$ (n = 2, 3, 4, 5...)
D-M9□W	10	20	55	$20 + 35 \frac{(n-2)}{2}$ (n = 2, 4, 6...) <sup>Note 3)</sup>	$55 + 35 (n-2)$ (n = 2, 3, 4, 5...)
D-M9□A	10	25	60	$25 + 35 \frac{(n-2)}{2}$ (n = 2, 4, 6...) <sup>Note 3)</sup>	$60 + 35 (n-2)$ (n = 2, 3, 4, 5...)
D-A9□	5	15	50	$15 + 35 \frac{(n-2)}{2}$ (n = 2, 4, 6...) <sup>Note 3)</sup>	$50 + 35 (n-2)$ (n = 2, 3, 4, 5...)
D-M9□V	5	20	35	$20 + 35 \frac{(n-2)}{2}$ (n = 2, 4, 6...) <sup>Note 3)</sup>	$35 + 35 (n-2)$ (n = 2, 3, 4, 5...)
D-A9□V	5	15	25	$15 + 35 \frac{(n-2)}{2}$ (n = 2, 4, 6...) <sup>Note 3)</sup>	$25 + 35 (n-2)$ (n = 2, 3, 4, 5...)
D-M9□WV D-M9□AV	10	20	35	$20 + 35 \frac{(n-2)}{2}$ (n = 2, 4, 6...) <sup>Note 3)</sup>	$35 + 35 (n-2)$ (n = 2, 3, 4, 5...)
D-C7□ D-C8□	5	20	60	$20 + 45 \frac{(n-2)}{2}$ (n = 2, 4, 6...) <sup>Note 3)</sup>	$60 + 45 (n-2)$ (n = 2, 3, 4, 5...)
D-H7□ D-H7□W D-H7BA D-H7NF	10	25	70	$25 + 45 \frac{(n-2)}{2}$ (n = 2, 4, 6...) <sup>Note 3)</sup>	$70 + 45 (n-2)$ (n = 2, 3, 4, 5...)
D-C73C D-C80C D-H7C	15	30	80	$30 + 50 \frac{(n-2)}{2}$ (n = 2, 4, 6...) <sup>Note 3)</sup>	$80 + 50 (n-2)$ (n = 2, 3, 4, 5...)
D-B5□ D-B64 D-G5□ D-K59□	10	25	70	$25 + 50 \frac{(n-2)}{2}$ (n = 2, 4, 6...) <sup>Note 3)</sup>	$70 + 50 (n-2)$ (n = 2, 3, 4, 5...)
D-B59W	15	30	75	$30 + 50 \frac{(n-2)}{2}$ (n = 2, 4, 6...) <sup>Note 3)</sup>	$75 + 50 (n-2)$ (n = 2, 3, 4, 5...)
D-A3□A D-G39A D-K39A D-A44A	20	35	110	$35 + 30 \frac{(n-2)}{2}$ (n = 2, 3, 4, 5...)	$110 + 100 (n-2)$ (n = 2, 3, 4, 5...)

Note 3) When "n" is an odd number, an even number that is one larger than this odd number is used for the calculation.

Note 1) Auto switch mounting

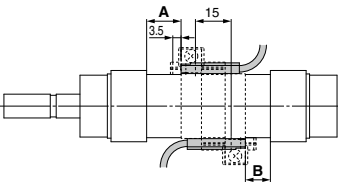
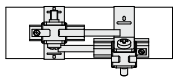
Auto switch model	With 2 auto switches	
	Different surfaces	Same surface
	 <p>The proper auto switch mounting position is 3.5 mm inward from the switch holder edge.</p>	 <p>The auto switch is mounted by slightly displacing it in a direction (cylinder tube circumferential exterior) so that the auto switch and lead wire do not interfere with each other.</p>
D-M9□ D-M9□W	Less than 20 stroke <sup>Note 2)</sup>	Less than 55 stroke <sup>Note 2)</sup>
D-M9□A	Less than 25 stroke <sup>Note 2)</sup>	Less than 60 stroke <sup>Note 2)</sup>
D-A9□	—	Less than 50 stroke <sup>Note 2)</sup>

Note 2) Minimum stroke for auto switch mounting in types other than those mentioned in Note 1.

## Operating Range

Auto switch model	Bore size (mm)			
	20	25	32	40
D-A9□	6	6	6	6
D-M9□ D-M9□W	3.5	3	3.5	3
D-C7□/C80 D-C73C/C80C	7	8	8	8
D-B5□/B64 D-A3□A/A44A	8	8	9	9
D-B59W	12	12	13	13
D-H7□/H7□W/H7BA D-G5NT/H7NF	4	4	4.5	5
D-H7C	7	8.5	9	10
D-G39A/K39A	8	9	9	9

\* Since the operating range is provided as a guideline including hysteresis, it cannot be guaranteed (assuming approximately ±30% dispersion). It may vary substantially depending on an ambient environment.

## Auto Switch Mounting Bracket: Part No.

Auto switch model	Bore size (mm)			
	20	25	32	40
D-M9□(V) D-M9□W(V) D-A9□(V)	Note 1) BM5-020 (A set of a, b, c, d)	Note 1) BM5-025 (A set of a, b, c, d)	Note 1) BM5-032 (A set of a, b, c, d)	Note 1) BM5-040 (A set of a, b, c, d)
D-M9□A(V) Note 2)	BM5-020S (A set of b, c, e, f)	BM5-025S (A set of b, c, e, f)	BM5-032S (A set of b, c, e, f)	BM5-040S (A set of b, c, e, f)
D-H7□ D-H7□W D-H7NF D-C7□/C80 D-C73C/C80C	BM2-020A (A set of c and d)	BM2-025A (A set of c and d)	BM2-032A (A set of c and d)	BM2-040A (A set of c and d)
D-H7BA	BM2-020AS (A set of c and f)	BM2-025AS (A set of c and f)	BM2-032AS (A set of c and f)	BM2-040AS (A set of c and f)
D-B5□/B64 D-B59W D-G5□/K59 D-G5□W/K59W D-G5BA/G59F D-G5NT	BA2-020 (A set of c and d)	BA2-025 (A set of c and d)	BA2-032 (A set of c and d)	BA2-040 (A set of c and d)
D-A3□A/A44A D-G39A/K39A	BM3-020 (A set of c and d)	BM3-025 (A set of c and d)	BM3-032 (A set of c and d)	BM3-040 (A set of c and d)

Note 1) Since the switch bracket (made from nylon) are affected in an environment where alcohol, chloroform, methylamines, hydrochloric acid or sulfuric acid is splashed over, so it cannot be used. Please consult SMC regarding other chemicals.

Note 2) When mounting a D-M9□A(V) type auto switch, if the switch bracket is mounted on the indicator light, it may damage the auto switch. Therefore, be sure to avoid mounting the switch bracket on the indicator light.

### [Mounting screw set made of stainless steel]

The following set of mounting screws made of stainless steel is available. Use it in accordance with the operating environment. (Please order the auto switch mounting bracket separately, since it is not included.)

BBA4: For D-C7/C8/H7 types

Note) Refer to page 1440 for the details of BBA4.

D-H7BA auto switch is set on the cylinder with the stainless steel screws above when shipped. When an auto switch is shipped independently, BBA4 is attached.

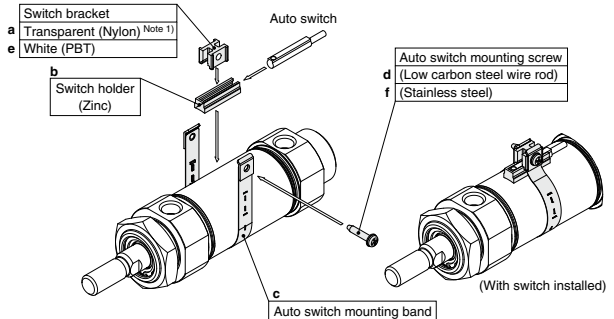

\* Band (c) is mounted so that the projected part is on the internal side (contact side with the tube).

Besides the models listed in How to Order, the following auto switches are applicable. Refer to pages 1341 to 1435 for the detailed specifications.

Auto switch type	Part no.	Electrical entry (Fetching direction)	Features
Reed	D-B53, C73, C76	Grommet (In-line)	—
	D-C80		Without indicator light
Solid state	D-H7A1, H7A2, H7B		—
	D-H7NW, H7PW, H7BW		Diagnostic indication (2-color)
	D-G5NT		With timer

\* For solid state auto switches, auto switches with a pre-wired connector are also available. Refer to pages 1410 and 1411 for details.  
\* Normally closed (NC = b contact) solid state auto switches (D-M9□E(V)) are also available. Refer to page 1360 for details.

# Fine Lock Cylinder

## Double Acting, Single Rod

# CLG1 Series

ø20, ø25, ø32, ø40



### How to Order

**CLG1 L N 25 100 E**

**With auto switch** **CDLG1 L N 25 100 E M9BW C**

**With auto switch**  
(Built-in magnet)

**Mounting type**

B	Basic type
L	Axial foot type
F	Rod side flange type
G	Head side flange type
U	Rod side trunnion type
T	Head side trunnion type
D	Clevis type

**Bore size**

20	20 mm
25	25 mm
32	32 mm
40	40 mm

**Port thread type**

Nil	Rc
TN	NPT

**Cylinder stroke (mm)**  
Refer to "Standard Strokes" on page 993.

**Number of auto switches**

Nil	2 pcs.
S	1 pc.
n	"n" pcs.

**Auto switch**

Nil	Without auto switch
-----	---------------------

\* For the applicable auto switch model, refer to the table below.

**Auto switch mounting bracket** <sup>(Note)</sup>

Note) This symbol is indicated when the D-A9□ or M9□ type auto switch is specified. This mounting bracket does not apply to other auto switches (D-C7□ and H7□, etc.) (Nil)

**Lock operation**

E	Spring locking (Exhaust locking)
P	Pneumatic locking (Pressure locking)
D	Spring and pneumatic locking

**Lock operation**

Nil	Without rod boot
J	Nylon tarpaulin
K	Heat resistant tarpaulin

**Cylinder symbol**

Nil	Without rod boot
J	Nylon tarpaulin
K	Heat resistant tarpaulin

**Type**

N	Non-lube/Rubber bumper
A	Non-lube/Air cushion

\* Mounting bracket is shipped together, (but not assembled).

**Built-in Magnet Cylinder Model**

If a built-in magnet cylinder without an auto switch is required, there is no need to enter the symbol for the auto switch. (Example) CDLG1FA32-100-P

**Made to Order**  
Refer to page 993 for details.

### Applicable Auto Switches

Refer to pages 1341 to 1435 for further information on auto switches.

Type	Special function	Electrical entry	Indicator light	Wiring (Output)	Load voltage		Auto switch model Applicable bore size		Lead wire length (m)					Pre-wired connector	Applicable load						
					DC	AC	Perpendicular	In-line	0.5 (Nil)	1 (M)	3 (L)	5 (Z)	None (N)								
Solid state auto switch	—	Grommet	Yes	3-wire (NPN)	5 V, 12 V	—	M9NV	M9N	●	●	○	○	○	○	IC circuit						
							M9PV	M9P	●	●	○	○	○	○							
		Connector		2-wire	M9BV	M9B	●	●	○	○	○	○	○	○	—						
					—	H7C	●	●	○	○	○	○	○	○	—						
	Diagnostic indication (2-color indicator)	Grommet	Yes	3-wire (NPN)	24 V	5 V, 12 V	—	M9NWX	M9NW	●	●	○	○	○	○	IC circuit					
								M9PWX	M9PW	●	●	○	○	○	○		○	○			
		Grommet		2-wire	M9BWX	M9BW	●	●	○	○	○	○	○	○	—						
					—	—	●	●	○	○	○	○	○	○	—						
		Water resistant (2-color indicator)		Grommet	Yes	3-wire (NPN)	5 V, 12 V	—	—	M9NAV*1	M9NA*1	○	○	○	○	○	○	IC circuit			
										M9PAV*1	M9PA*1	○	○	○	○	○	○		○	○	
Reed auto switch	Diagnostic indication (2-color indicator)	Grommet	Yes	2-wire	5 V, 12 V	—	—	M9BAV*1	M9BA*1	○	○	○	○	○	○	—					
								—	—	●	●	○	○	○	○		○	○			
								—	—	●	●	○	○	○	○		○	○	○		
								—	—	●	●	○	○	○	○		○	○	○		
Reed auto switch	Diagnostic indication (2-color indicator)	Grommet	Yes	3-wire (NPN equivalent)	5 V	—	—	A96V	A96	●	●	○	○	○	IC circuit						
								A93V*2	A93	●	●	○	○	○		○					
								A90V	A90	●	●	○	○	○		○	○				
								—	B54	●	●	○	○	○		○	○	○			
								—	B64	●	●	○	○	○		○	○	○			
		Connector		2-wire	24 V	12 V	—	—	—	—	—	C73C	●	●	○	○	○	IC circuit			
											—	C80C	●	●	○	○	○		○	○	
											—	B59W	●	●	○	○	○		○	○	○
											—	—	●	●	○	○	○		○	○	○
											—	—	●	●	○	○	○		○	○	○

\*1 Water resistant type auto switches can be mounted on the above models, but in such case SMC cannot guarantee the water resistance. A water-resistant type cylinder is recommended for use in an environment which requires water resistance. However, please contact SMC for water-resistant products of ø20 and ø25.

\*2 1 m type lead wire is only applicable to D-A93.

\* Lead wire length symbols: 0.5 m ..... Nil (Example) M9NV      5 m ..... Z (Example) M9NWX  
 1 m ..... M (Example) M9PV      None ..... N (Example) H7C  
 3 m ..... L (Example) M9BWX

\* Since there are other applicable auto switches than listed above, refer to page 1003 for details.

\* For details about auto switches with pre-wired connector, refer to pages 1410 and 1411.

\* D-A9□(V)/M9□(V)/M9□(V)/M9□A(V) auto switches are shipped together (not assembled). (Only auto switch mounting brackets are assembled at the time of shipment.)

# Fine Lock Cylinder Double Acting, Single Rod **CLG1 Series**

**Provided with a compact lock mechanism, it is suitable for intermediate stop, emergency stop, and drop prevention.**

## Locking in both directions

The piston rod can be locked in either direction of its cylinder stroke.

## Maximum piston speed: 500 mm/s

It can be used at 50 to 500 mm/s provided that it is within the allowable kinetic energy range.

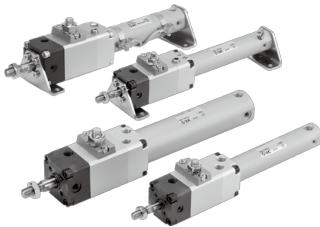

## Symbol

Rubber bumper

Air cushion

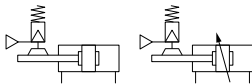

**Made to Order Specifications**  
Click here for details

Symbol	Specifications
-XA□	Change of rod end shape

## Weight

(kg)

Bore size (mm)		20	25	32	40
Basic weight	Basic type	0.61	0.97	1.06	1.35
	Axial foot type	0.72	1.10	1.22	1.57
	Flange type	0.73	1.15	1.23	1.58
	Trunnion type	0.62	0.99	1.09	1.40
	Clevis type	0.66	1.05	1.21	1.58
	Rod side pivot bracket	0.11	0.13	0.20	0.27
Head side pivot bracket	0.08	0.09	0.17	0.25	
Single knuckle joint	0.05	0.09	0.09	0.10	
Double knuckle joint (with pin)	0.05	0.09	0.09	0.13	
Additional weight per each 50 mm of stroke	0.05	0.07	0.09	0.15	
Additional weight with air cushion	0.01	0.01	0.02	0.02	
Additional weight for long stroke	0.01	0.01	0.02	0.03	

Calculation: (Example)

- CLG1LA20-100** (Foot Type, ø20, 100 st)
- Basic weight.....0.72
  - Additional weight.....0.05/50 st
  - Air cylinder stroke.....100 st
  - Additional weight of air cushion.....0.01 kg
- 0.72 + 0.05 × 100/50 + 0.01 = 0.83 kg

## Model

Series	Type	Action	Cushion	Bore size (mm)	Lock operation
CLG1□N	Non-lube	Double acting	Rubber bumper	20, 25	Spring locking (Exhaust locking) Pneumatic locking (Pressure locking) Spring and pneumatic locking
CLG1□A			Air cushion	32, 40	

## Specifications

Bore size (mm)		20	25	32	40
Fluid	Air				
Lubrication	Not required (Non-lube)				
Proof pressure	1.5 MPa				
Maximum operating pressure	1.0 MPa				
Minimum operating pressure	0.08 MPa				
Ambient and fluid temperature	Without auto switch: -10 to 70°C (No freezing) With auto switch: -10 to 60°C (No freezing)				
Piston speed	50 to 500 mm/sec *				
Stroke length tolerance	Up to 1000 st + <sup>+1.4</sup> <sub>0</sub> mm, 1001 to 1500 st + <sup>+1.8</sup> <sub>0</sub> mm				
Cushion	Rubber bumper, Air cushion				
Mounting **	Basic type, Axial foot type, Rod side flange type, Head side flange type, Rod side trunnion type, Head side trunnion type, Clevis type (Used when port position is changed to 90°)				

\* Constraints associated with the allowable kinetic energy are imposed on the speeds at which the piston can be locked.  
The maximum speed of 1000 mm/s can be accommodated if the piston is to be locked in the stationary state for the purpose of drop prevention.

\*\* The long stroke type is applicable to the axial foot type, and the rod side flange type.

## Fine Lock Specifications

Lock operation	Spring locking (Exhaust locking)	Spring and pneumatic locking	Pneumatic locking (Pressure locking)
Fluid	Air		
Maximum operating pressure	0.5 MPa		
Unlocking pressure	0.3 MPa or more	0.1 MPa or more	
Lock starting pressure	0.25 MPa or less	0.05 MPa or more	
Locking direction	Both directions		

## Accessory

Mounting		Basic type	Axial foot type	Rod side flange type	Head side flange type	Rod side trunnion type	Head side trunnion type	Clevis type
Standard equipment	Rod end nut	●	●	●	●	●	●	●
	Clevis pin	—	—	—	—	—	—	●
Option	Single knuckle joint	●	●	●	●	●	●	●
	Double knuckle joint* (With pin)	—	●	●	●	●	●	●
	Pivot bracket	—	—	—	—	●	●	●
	Rod boot	●	●	●	●	●	●	●

\* Pin and retaining ring are shipped together with double knuckle joint.

\*\* For part numbers and dimensions, refer to page 999. (For rod boots, refer to pages 995 and 997.)

## Standard Stroke / with an auto switch.

Bore size	Standard stroke *	Manufacturable stroke
20	25, 50, 75, 100, 125, 150, 200	1 to 1500
25		
32		
40		
50, 63	25, 50, 75, 100, 125,	
80	150, 200, 250, 300	
100		

\* Intermediate strokes not listed above are produced upon receipt of order. Manufacture of intermediate strokes at 1 mm intervals is possible. (Spacers are not used.)

\*\* Applicable strokes should be confirmed according to the usage. For details, refer to "Air Cylinders Model Selection" in the **Web Catalog**. In addition, the products that exceed the standard stroke might not be able to fulfill the specifications due to the deflection etc.

## Rod Boot Material

Symbol	Rod boot material	Maximum ambient temperature
J	Nylon tarpaulin	70°C
K	Heat resistant tarpaulin	110°C *

\* Maximum ambient temperature for the rod boot itself.

Refer to pages 1000 to 1003 for cylinders with auto switches.

- Minimum auto switch mounting stroke
- Proper auto switch mounting position (detection at stroke end) and mounting height
- Operating range
- Switch mounting bracket: Part no.

# CLG1 Series

## ⚠ Caution/Allowable Kinetic Energy when Locking

Bore size (mm)	20	25	32	40
Allowable kinetic energy (J)	0.26	0.42	0.67	1.19

- In terms of specific load conditions, the allowable kinetic energy indicated in the table above is equivalent to a 50% load ratio at 0.5 MPa, and a piston speed of 300 mm/sec. Therefore, if the operating conditions are below these values, calculations are unnecessary.
- Apply the following formula to obtain the kinetic energy of the load.
 
$$Ek = \frac{1}{2} m v^2$$
 Ek: Kinetic energy of load (J)  
 m: Load mass (kg)  
 v: Piston speed (m/s) (Average speed x 1.2 times)
- The piston speed will exceed the average speed immediately before locking. To determine the piston speed for the purpose of obtaining the kinetic energy of load, use 1.2 times the average speed as a guide.
- The relation between the speed and the load of the respective tube bores is indicated in the diagram below. Use the cylinder in the range below the line.
- Even within a given allowable kinetic energy level, there is an upper limit to the size of the load that can be sustained. Thus, a horizontally mounted cylinder must be operated below the solid line, and a vertically mounted cylinder must be operated below the dotted line.

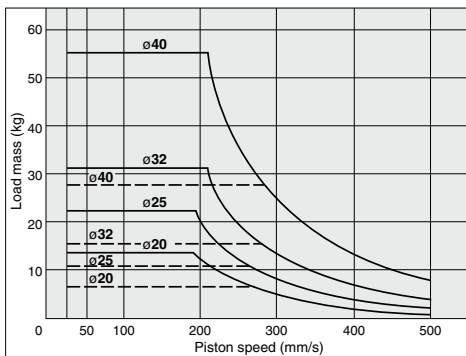

## Holding Force of Spring Locking (Maximum static load)

Bore size (mm)	20	25	32	40
Holding force (N)	196	313	443	784

Note) Holding force at piston rod extended side decreases approximately 15%.

## Holding Force of Pneumatic Locking (Maximum static load)

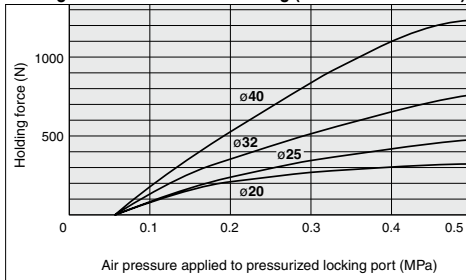

\* When selecting cylinders, refer to the Precautions and allowable kinetic energy when locking on page 1004, and then select a cylinder.

## ⚠ Caution

### Caution when Locking

Holding force (maximum static load) means the maximum capability of holding a static load that is not accompanied by vibration or impact under the condition that no load is applied. Therefore, it does not refer to a load that cannot be held constantly.

When using (selecting) this product, carefully check the following points.

- If the piston rod slips because the lock's holding force has been exceeded, the brake shoe could be damaged, resulting in a reduced holding force or shortened life.
- The upper limit of the load that is used under the conditions not associated with the kinetic energy when locking, such as drop prevention must be 35% or less of the holding force.
- Do not use the cylinder in the locked state to sustain a load that involves impact.

## Stopping Accuracy (Not including tolerance of control system.) (mm)

Locking method	Piston speed (mm/s)			
	50	100	300	500
Spring locking (Exhaust locking)	±0.4	±0.5	±1.0	±2.0
Pneumatic locking (Pressure locking)	±0.2	±0.3	±0.5	±1.5
Spring and pneumatic locking				

Condition/load: 25% of thrust force at 0.5 MPa

Solenoid valve: Mounted to the lock port

## ⚠ Caution

### Selection/Recommended Pneumatic Circuit/Caution on Handling

For detailed specifications of the fine lock cylinder, CLG1 series mentioned above, refer to pages 1004 to 1007.

## Operating Precautions

## ⚠ Warning

- Do not operate the cushion valve in the fully closed or fully opened state.  
Using it in the fully closed state will cause the cushion seal to be damaged. Using it in the fully opened state will cause the piston rod assembly or the cover to be damaged.
- Operate within the specified cylinder speed.  
Otherwise, cylinder and seal damage may occur.
- Carefully check the cushion performance in a low speed range.  
The performance and effect at around 50 mm/s may vary depending on the individual difference of each product.
- If a cylinder is actuated at high speed when mounted with one side fastened and one side free (basic type, flange type, direct mount type), the bending moment may act on the cylinder due to vibration at the stroke end, causing damage to the cylinder. In such cases, install a mounting bracket to suppress vibration of the cylinder body, or reduce piston speed until the cylinder body does not vibrate at the stroke end. Also, use a mounting bracket when moving the cylinder body, or mounting a long stroke cylinder horizontally with one-sided fastening.

## ⚠ Caution

- Install a rod boot without twisting.  
If the cylinder is installed with its bellows twisted, it could damage the bellows.
- Tighten clevis bracket mounting bolts with the following proper tightening torque.  
 ø20: 1.5N·m, ø25 to 32: 2.9N·m, ø40: 4.9N·m,  
 ø50: 11.8N·m, ø63 to 80: 24.5N·m, ø100: 42.2N·m

## Mounting Bracket Part No.

Mounting bracket	Bore size (mm)			
	20	25	32	40
Axial foot *	CNG-L020	CNG-L025	CNG-L032	CNG-L040
Flange	CNG-F020	CNG-F025	CNG-F032	CNG-F040
Trunnion pin	CG-T020	CG-T025	CG-T032	CG-T040
Clevis **	CG-D020	CG-D025	CG-D032	CG-D040
Rod side pivot bracket	CNG-020-24	CNG-025-24	CNG-032-24	CNG-040-24
Head side pivot bracket	CG-020-24A	CG-025-24A	CG-032-24A	CG-040-24A

\* When ordering foot bracket, order 2 pieces per cylinder.

\*\* For the clevis type, clevis pins, retaining rings and mounting bolts are included.

\*\*\* Mounting bolts are shipped together for the foot and flange types.



# Fine Lock Cylinder Double Acting, Single Rod **CLG1 Series**

## Basic Type: CLG1BN

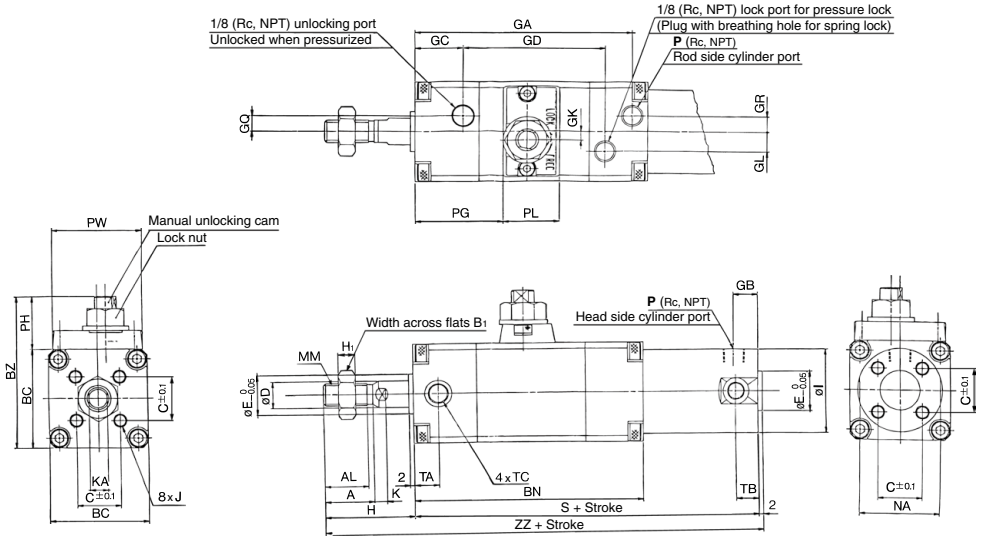

## CLG1 With rod boot (Mounting bracket: Basic type)

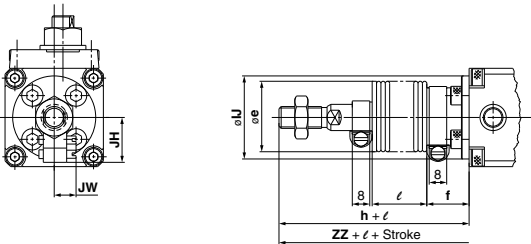

Bore size (mm)	Stroke range	AL	A	B <sub>1</sub>	BC	BN	BZ	C	D	E	GA	GB	GC	GD	GK	GL	GQ	GR	I	J	K	KA	MM
20	Up to 200	15.5	18	13	38	91	57.5	14	8	12	84	10	19	54	3.5	5.5	4	4	26	M4 x 0.7 depth 7	5	6	M8 x 1.25
25	Up to 300	19.5	22	17	45	101	69	16.5	10	14	94	10	20	62	4	9	7	7	31	M5 x 0.8 depth 7.5	5	8	M10 x 1.25
32	Up to 300	19.5	22	17	45	102	69	20	12	18	95	10	21	62	4	9	7	7	38	M5 x 0.8 depth 8	5.5	10	M10 x 1.25
40	Up to 300	27	30	19	52	111	76	26	16	25	103	10	23	67	4	11	8	7	47	M6 x 1 depth 12	6	14	M14 x 1.5

Bore size (mm)	Stroke range	H <sub>1</sub>	NA	P	PG	PH	PL	PW	S	TA	TB	TC	Without rod boot		With rod boot					ℓ	ZZ	
													H	ZZ	IJ	JH (Reference)	JW (Reference)	e	f			h
20	Up to 200	5	24	1/8	33	19.5	20	38	141	11	11	M5 x 0.8	35	178	27	15.5	10.5	30	18	55	1/4 stroke	198 (206)
25	Up to 300	6	29	1/8	38	24	24	41	151	11	11	M6 x 0.75	40	193	32	16.5	10.5	30	19	62		215 (223)
32	Up to 300	6	35.5	1/8	39	24	24	41	154	11	10	M8 x 1	40	196	38	18.5	10.5	35	19	62		218 (226)
40	Up to 300	8	44	1/8	44	24	24	41	169	12	10	M10 x 1.25	50	221	48	21.5	10.5	35	19	70	241 (250)	

\* For long stroke refer to page 997.

\*\* The minimum stroke for cylinders with a rod boot is 20 mm.

# CLG1 Series

## With Mounting Bracket

### Foot type: CLG1LN

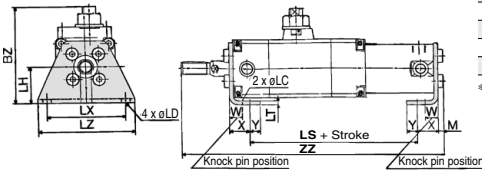

### Foot Type

Bore size (mm)	BZ	M	W	X	Y	LC	LD	LH	LS	LT	LX	LZ	Without rod boot	With rod boot
													ZZ	ZZ
20	63.5	3	10	15	7	4	6	25	117	3	50	62	182 + stroke	202 + 1.25 stroke
25	74.5	3.5	10	15	7	4	6	28	127	3	57	70	197.5 + stroke	219.5 + 1.25 stroke
32	74.5	3.5	10	16	8	4	7	28	128	3	60	74	200.5 + stroke	222.5 + 1.25 stroke
40	83	4	10	16.5	8.5	4	7	33	142	3	68	84	226 + stroke	246 + 1.25 stroke

\* For long stroke, refer to page 997.

### Rod side flange type: CLG1FN

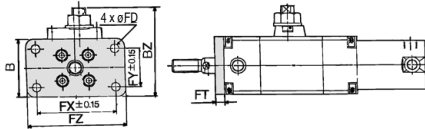

### Head side flange type: CLG1GN

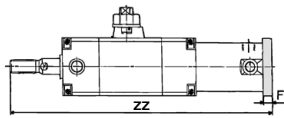

### Rod Side Flange Type

Bore size (mm)	B	BZ	FD	FT	FX	FY	FZ
20	38	57.5	5.5	6	52	25	65
25	45	69	5.5	7	60	30	75
32	45	69	6.6	7	60	30	75
40	52	76	6.6	8	66	36	82

\* For long stroke, refer to page 997.

### Rod side trunnion type: CLG1UN

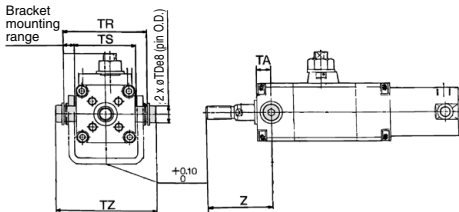

### Rod Side Trunnion Type

Bore size (mm)	TD <sub>Des</sub>	TR	TS	TZ	Without rod boot	With rod boot
					Z	Z
20	8 <sup>+0.025</sup> <sub>-0.047</sub>	51	40	59.6	46	66 + 0.25 stroke
25	10 <sup>+0.025</sup> <sub>-0.047</sub>	58	47	68	51	73 + 0.25 stroke
32	12 <sup>+0.032</sup> <sub>-0.059</sub>	62.5	47	75.7	51	73 + 0.25 stroke
40	14 <sup>+0.032</sup> <sub>-0.059</sub>	72.5	54	85.7	62	82 + 0.25 stroke

### Head side trunnion type: CLG1TN

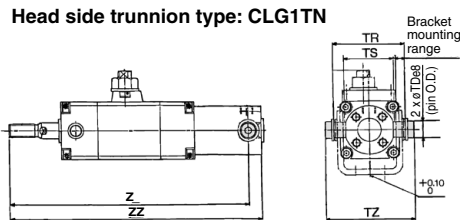

### Head Side Trunnion Type

Bore size (mm)	TD <sub>Des</sub>	TR	TS	TZ	Without rod boot		With rod boot	
					Z	ZZ	Z	ZZ
20	8 <sup>+0.025</sup> <sub>-0.047</sub>	39	28	47.6	165 + stroke	178 + stroke	185 + 1.25 stroke	198 + 1.25 stroke
25	10 <sup>+0.025</sup> <sub>-0.047</sub>	43	33	53	180 + stroke	193 + stroke	202 + 1.25 stroke	215 + 1.25 stroke
32	12 <sup>+0.032</sup> <sub>-0.059</sub>	54.5	40	67.7	184 + stroke	196 + stroke	206 + 1.25 stroke	218 + 1.25 stroke
40	14 <sup>+0.032</sup> <sub>-0.059</sub>	65.5	49	78.7	209 + stroke	221 + stroke	229 + 1.25 stroke	241 + 1.25 stroke

### Clevis type: CLG1DN

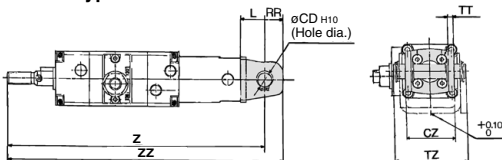

### Clevis Type

Bore size (mm)	CD <sub>H10</sub>	CZ	L	RR	TT	TZ
20	8 <sup>+0.058</sup> <sub>0</sub>	29	14	11	3.2	43.4
25	10 <sup>+0.058</sup> <sub>0</sub>	33	16	13	3.2	48
32	12 <sup>+0.070</sup> <sub>0</sub>	40	20	15	4.5	58.4
40	14 <sup>+0.070</sup> <sub>0</sub>	49	22	18	4.5	71.4

\* Clevis pin and retaining ring are attached.

Bore size (mm)	Without rod boot		With rod boot	
	Z	ZZ	Z	ZZ
20	190 + stroke	201 + stroke	210 + 1.25 stroke	221 + 1.25 stroke
25	207 + stroke	220 + stroke	229 + 1.25 stroke	242 + 1.25 stroke
32	214 + stroke	229 + stroke	236 + 1.25 stroke	251 + 1.25 stroke
40	241 + stroke	259 + stroke	261 + 1.25 stroke	279 + 1.25 stroke

# Fine Lock Cylinder Double Acting, Single Rod **CLG1 Series**

## Basic Type with Air Cushion: CLG1BA

\* Refer to page 996 for mounting bracket, since the dimensions except GA, P, WA, WB, WH, WW, Wθ are the same.

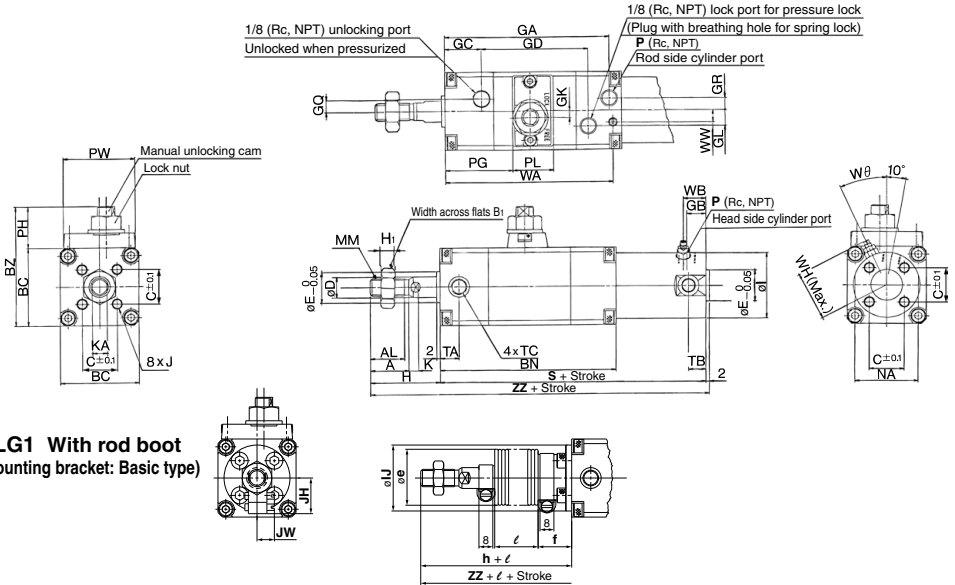

**CLG1 With rod boot**  
(Mounting bracket: Basic type)

Bore size (mm)	Stroke range	AL	A	B <sub>1</sub>	BC	BN	BZ	C	D	E	GA	GB	GC	GD	GK	GL	GQ	GR	I	J	K	KA	MM	NA	H <sub>1</sub>
20	Up to 200	15.5	18	13	38	91	57.5	14	8	12	85	10	19	54	3.5	5.5	4	4	26	M4 x 0.7 depth 7	5	6	M8 x 1.25	24	5
25	Up to 300	19.5	22	17	45	101	69	16.5	10	14	95	10	20	62	4	9	7	7	31	M5 x 0.8 depth 7.5	5.5	8	M10 x 1.25	29	6
32	Up to 300	19.5	22	17	45	102	69	20	12	18	95	10	21	62	4	9	7	7	38	M5 x 0.8 depth 8	5.5	10	M10 x 1.25	35.5	6
40	Up to 300	27	30	19	52	111	76	26	16	25	103	10	23	67	4	11	8	7	47	M6 x 1 depth 12	6	14	M14 x 1.5	44	8

Bore size (mm)	Stroke range	P	PG	PH	PL	PW	S	TA	TB	TC	WA	WW	WB	WH	Wθ	Without rod boot		With rod boot									
																H	ZZ	JH	JW (Reference)	JW (Reference)	e	f	h	l	ZZ	stroke	
20	Up to 200	M5 x 0.8	33	19.5	20	38	141	11	11	M5 x 0.8	86	5.5	15	23	30°	35	178	27	15.5	10.5	30	18	55	198 (206)			
25	Up to 300	M5 x 0.8	38	24	24	41	151	11	11	M6 x 0.75	96	6	15	25	30°	40	193	32	16.5	10.5	30	19	62	215 (223)			
32	Up to 300	1/8	39	24	24	41	154	11	10	M8 x 1	97	6	15	28.5	25°	40	196	38	18.5	10.5	35	19	62	218 (226)			
40	Up to 300	1/8	44	24	24	41	169	12	10	M10 x 1.25	106	8	15	33	20°	50	221	48	21.5	10.5	35	19	70	241 (250)			

\* The minimum stroke for cylinders with a rod boot is 20 mm.

**Long Stroke** Refer to pages 995 to 997 for mounting dimensions except the table below.

### Basic type

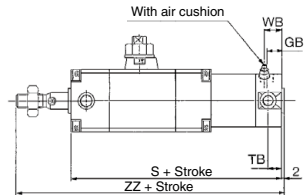

Bore size (mm)	Stroke range	GB	S	Without rod boot ZZ	With rod boot ZZ	TB	WB
20	201 to 1500	12	149	186	206	11	16
25	301 to 1500	12	159	201	223	11	16
32	301 to 1500	12	162	204	226	11	16
40	301 to 1500	13	178	230	250	12	16

### Foot type

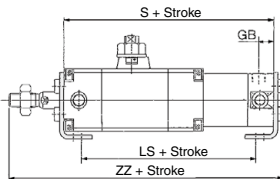

Bore size (mm)	Stroke range	GB	S	LS	Without rod boot ZZ	With rod boot ZZ
20	201 to 1500	12	149	125	190	210
25	301 to 1500	12	159	135	205.5	227.5
32	301 to 1500	12	162	136	208.5	230.5
40	301 to 1500	13	178	151	235	255

### Rod side flange type

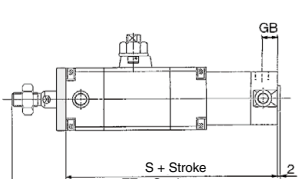

Bore size (mm)	Stroke range	GB	S	Without rod boot ZZ	With rod boot ZZ
20	201 to 1500	12	149	186	206
25	301 to 1500	12	159	201	223
32	301 to 1500	12	162	204	226
40	301 to 1500	13	178	230	250

# CLG1 Series

## Construction

### With rubber bumper: CLG1BN

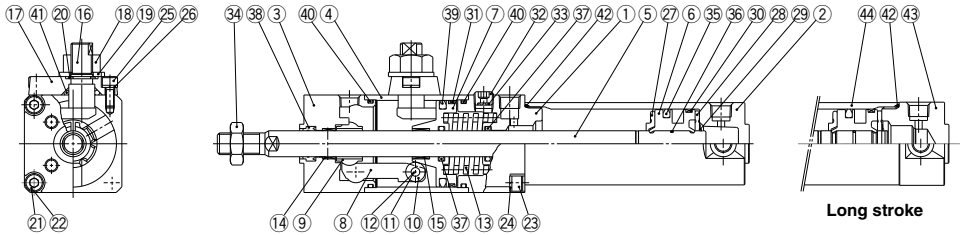

### With air cushion: CLG1BA

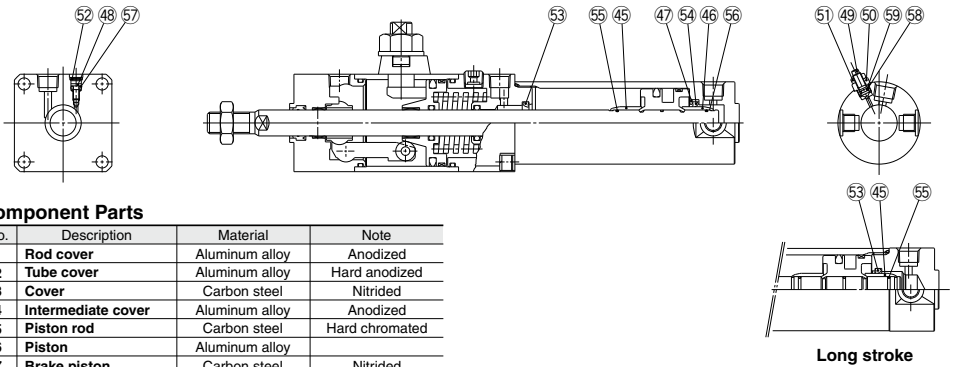

### Component Parts

No.	Description	Material	Note
1	Rod cover	Aluminum alloy	Anodized
2	Tube cover	Aluminum alloy	Hard anodized
3	Cover	Carbon steel	Nitrided
4	Intermediate cover	Aluminum alloy	Anodized
5	Piston rod	Carbon steel	Hard chromated
6	Piston	Aluminum alloy	
7	Brake piston	Carbon steel	Nitrided
8	Brake arm	Carbon steel	Nitrided
9	Brake shoe	Special friction material	
10	Roller	Carbon steel	Nitrided
11	Pin	Carbon steel	Heat treated
12	Retaining ring	Carbon tool steel	
13	Brake spring	Spring steel wire	Anti-corrosive treatment: Types C, E only
14	Bushing	Bearing alloy	
15	Bushing	Bearing alloy	
16	Manual lock release cam	Chromium molybdenum steel	Nitrided, nickel plated
17	Cam guide	Carbon steel	Nitrided, painted
18	Lock nut	Rolled steel	
19	Flat washer	Rolled steel	
20	Retaining ring	Carbon tool steel	
21	Hexagon socket head cap screw	Chromium molybdenum steel	
22	Spring washer	Steel wire	
23	Hexagon socket head cap screw	Chromium molybdenum steel	
24	Spring washer	Steel wire	
25	Hexagon socket head cap screw	Chromium molybdenum steel	
26	Spring washer	Steel wire	
27	Bumper A	Resin	
28	Bumper B	Resin	
29	Retaining ring	Stainless steel	
30	Wear ring	Resin	
31	Wear ring	Resin	
32	Hexagon socket head plug	Carbon steel	Type E only
33	Element	Bronze	Type E only
34	Rod end nut	Carbon steel	Trivalent zinc chromated
35	Piston seal	NBR	
36	Piston gasket	NBR	
37	Rod seal A	NBR	
38	Rod seal B	NBR	
39	Brake piston seal	NBR	
40	Intermediate cover gasket	NBR	
41	Cam gasket	NBR	

No.	Description	Material	Note
42	Cylinder tube gasket	NBR	
43	Head cover	Aluminum alloy	Anodized
44	Cylinder tube	Aluminum alloy	Hard anodized
45	Cushion ring A	Aluminum alloy	Anodized
46	Cushion ring B	Aluminum alloy	Anodized
47	Seal retaining	Rolled steel	Zinc chromated
48	Cushion valve A	Chromium molybdenum steel	Electroless nickel plated
49	Cushion valve B	Rolled steel	Electroless nickel plated
50	Valve retaining	Rolled steel	Electroless nickel plated
51	Lock nut	Rolled steel	Electroless nickel plated
52	Retaining ring	Stainless steel	
53	Cushion seal A	Urethane	
54	Cushion seal B	Urethane	
55	Cushion ring gasket A	NBR	
56	Cushion ring gasket B	NBR	
57	Valve seal A	NBR	
58	Valve seal B	NBR	
59	Valve retaining gasket	NBR	

### Replacement Parts: Seal Kit

Bore size (mm)	Kit no.	Contents
20	CG1N20-PS	Set of nos. above 35, 38, 42
25	CG1N25-PS	
32	CG1N32-PS	
40	CG1N40-PS	

\* Since the lock section for CLG1 series is normally replaced as a unit, kits are for the cylinder section only.

\* Seal kit includes a grease pack (10 g).  
Order with the following part number when only the grease pack is needed.

Grease pack part no.: GR-S-010 (10 g)

# CLG1 Series Accessory Bracket Dimensions

## Single Knuckle Joint

### I-G02/G03

Material: Rolled steel

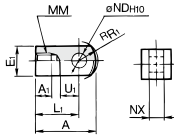

### I-G04

Material: Cast iron

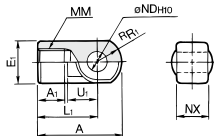

Part no.	Applicable bore size (mm)	A	A1	E1	L1	MM	RPR1	U1	NDH10	NX
I-G02	20	34	8.5	16	25	M8 x 1.25	10.3	11.5	8 <sup>+0.058</sup> <sub>0</sub>	8 <sup>-0.2</sup> <sub>0</sub>
I-G03	25, 32	41	10.5	20	30	M10 x 1.25	12.8	14	10 <sup>+0.058</sup> <sub>0</sub>	10 <sup>-0.2</sup> <sub>0</sub>
I-G04	40	42	14	ø22	30	M14 x 1.5	12	14	10 <sup>+0.058</sup> <sub>0</sub>	18 <sup>-0.2</sup> <sub>0</sub>

## Rod Side Pivot Bracket

ø20 to ø40

Material: Rolled steel

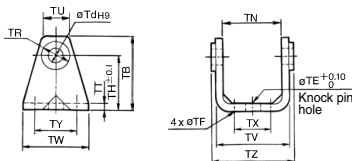

Part no.	Applicable bore size (mm)	TB	TdHø	TE	TF	TH	TN
CNG-020-24	20	42	8 <sup>+0.036</sup> <sub>0</sub>	10	5.5	31	40
CNG-025-24	25	48	10 <sup>+0.036</sup> <sub>0</sub>	10	5.5	37	47
CNG-032-24	32	53	12 <sup>+0.043</sup> <sub>0</sub>	10	6.6	38.5	47
CNG-040-24	40	60	14 <sup>+0.043</sup> <sub>0</sub>	10	6.6	42.5	55

Part no.	Applicable bore size (mm)	TR	TT	TU	TV	TW	TX	TY	TZ
CNG-020-24	20	13	3.2	21.2	47.8	42	26	28	50
CNG-025-24	25	15	3.2	21.3	54.8	42	28	28	57
CNG-032-24	32	17	4.5	25.6	57.4	48	28	28	61.4
CNG-040-24	40	21	4.5	26.3	65.4	56	36	30	71.4

## Knuckle Pin

Material: Carbon steel

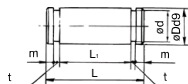

Part no.	Applicable bore size (mm)	Dd9	L	d	L1	m	t	Applicable retaining ring
IY-G02	20	8 <sup>+0.040</sup> <sub>-0.020</sub>	21	7.6	16.2	1.5	0.9	Type C 8 for axis
IY-G03	25, 32	10 <sup>+0.040</sup> <sub>-0.020</sub>	26.6	9.6	20.2	1.55	1.15	Type C 10 for axis
IY-G04	40	10 <sup>+0.040</sup> <sub>-0.020</sub>	41.6	9.6	36.2	1.55	1.15	Type C 10 for axis

\* Retaining rings are included.

## Clevis Pin

Material: Carbon steel

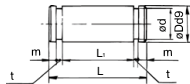

Part no.	Applicable bore size (mm)	Dd9	L	d	L1	m	t	Applicable retaining ring
CD-G02	20	8 <sup>+0.040</sup> <sub>-0.020</sub>	43.4	7.6	38.6	1.5	0.9	Type C 8 for axis
CD-G25	25	10 <sup>+0.040</sup> <sub>-0.020</sub>	48	9.6	42.6	1.55	1.15	Type C 10 for axis
CD-G03	32	12 <sup>+0.040</sup> <sub>-0.020</sub>	59.4	11.5	54	1.55	1.15	Type C 12 for axis
CD-G04	40	14 <sup>+0.040</sup> <sub>-0.020</sub>	71.4	13.4	65	2.05	1.15	Type C 14 for axis

\* Retaining rings are included.

## Double Knuckle Joint \* Knuckle pin and retaining ring are packaged.

### Y-G02/G03

Material: Rolled steel

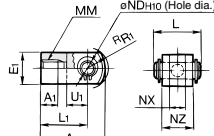

### Y-G04

Material: Cast iron

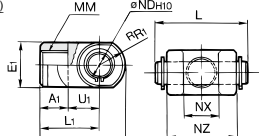

Part no.	Applicable bore size (mm)	A	A1	E1	L1	MM	RPR1	U1	NDH10	NX	NZ	L	Applicable pin part no.
Y-G02	20	34	8.5	16	25	M8 x 1.25	10.3	11.5	8 <sup>+0.058</sup> <sub>0</sub>	8 <sup>-0.2</sup> <sub>0</sub>	16	21	IY-G02
Y-G03	25, 32	41	10.5	20	30	M10 x 1.25	12.8	14	10 <sup>+0.058</sup> <sub>0</sub>	10 <sup>-0.2</sup> <sub>0</sub>	20	25.6	IY-G03
Y-G04	40	42	16	ø22	30	M14 x 1.5	12	14	10 <sup>+0.058</sup> <sub>0</sub>	18 <sup>-0.2</sup> <sub>0</sub>	36	41.6	IY-G04

## Head Side Pivot Bracket

ø20 to ø40

Material: Rolled steel

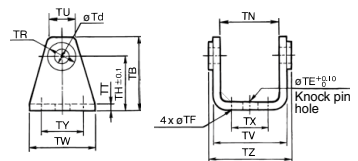

Part no.	Applicable bore size (mm)	TB	Td	TE	TF	TH	TN
CG-020-24A	20	36	8	10	5.5	25	(29.3)
CG-025-24A	25	43	10	10	5.5	30	(33.1)
CG-032-24A	32	50	12	10	6.6	35	(40.4)
CG-040-24A	40	58	14	10	6.6	40	(49.2)

Part no.	Applicable bore size (mm)	TR	TT	TU	TV	TW	TX	TY	TZ
CG-020-24A	20	13	3.2	18.1	35.8	42	16	28	38.3
CG-025-24A	25	15	3.2	20.7	39.8	42	20	28	42.1
CG-032-24A	32	17	4.5	23.6	49.4	48	22	28	53.8
CG-040-24A	40	21	4.5	27.3	58.4	56	30	30	64.6

## Rod End Nut

Material: Carbon steel

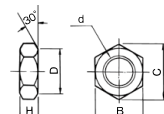

Part no.	Applicable bore size (mm)	B	C	D	d	H
NT-02	20	13	15.0	12.5	M8 x 1.25	5
NT-03	25, 32	17	19.6	16.5	M10 x 1.25	6
NT-G04	40	19	21.9	18	M14 x 1.5	8

# Auto Switch Mounting 1

## Auto Switch Proper Mounting Position (Detection at Stroke End) and Its Mounting Height

### Reed auto switch

D-A9□

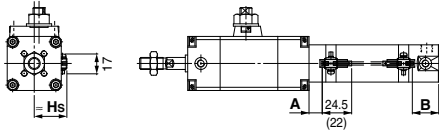

( ): For D-A96

D-C7/C8

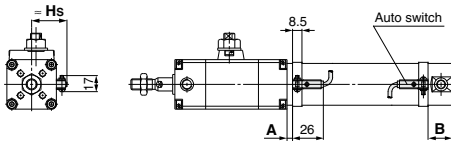

D-C73C/C80C

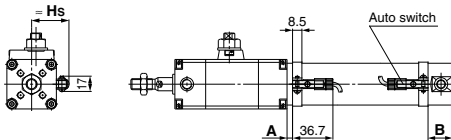

D-B5/B6/B59W

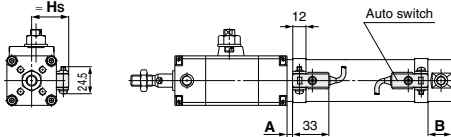

### Solid state auto switch

D-M9□

D-M9□A

D-M9□W

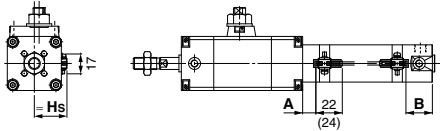

( ): For D-M9□A

D-G5NT

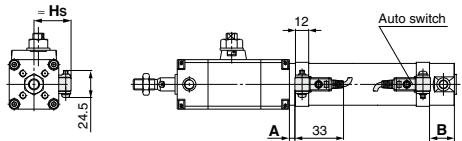

D-H7□/H7□W

D-H7NF/H7BA

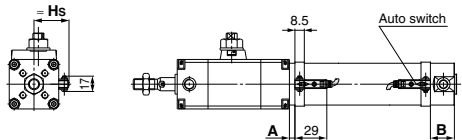

D-H7C

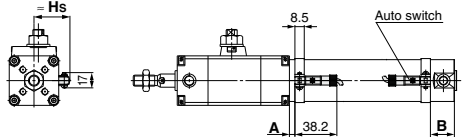

### Auto Switch Proper Mounting Position

(mm)

Auto switch model	D-M9□(V) D-M9□W(V) D-M9□A(V)		D-A9□(V)		D-C7/C8 D-C73C D-C80C		D-B5 D-B6		D-B59W		D-H7□ D-H7C D-H7□W D-H7BA D-H7NF		D-G5□W D-K59W D-G59F D-G5 D-K5 D-G5NT D-G5BA	
	A	B	A	B	A	B	A	B	A	B	A	B	A	B
20	10.5	27 (35)	6.5	23 (31)	7	23.5 (31.5)	1	17.5 (25.5)	4	20.5 (28.5)	6	22.5 (30.5)	2.5	19 (27)
25	10.5	27 (35)	6.5	23 (31)	7	23.5 (31.5)	1	17.5 (25.5)	4	20.5 (28.5)	6	22.5 (30.5)	2.5	19 (27)
32	10.5	29 (37)	6.5	25 (33)	7	25.5 (33.5)	1	19.5 (27.5)	4	22.5 (30.5)	6	24.5 (32.5)	2.5	21 (29)
40	13.5	32 (41)	9.5	28 (37)	10	28.5 (37.5)	4	22.5 (31.5)	7	25.5 (34.5)	9	27.5 (36.5)	5.5	24 (33)

### Auto Switch Mounting Height

(mm)

Auto switch model	D-M9□(V) D-M9□W(V) D-M9□A(V)		D-H7□ D-H7NF D-H7BA D-C7/C8		D-C73C D-C80C		D-B5/B6 D-B59W D-G5/K5 D-K59W D-G5BA	
	Hs		Hs		Hs		Hs	
20	26.5		27		27.5		27.5	
25	29		29.5		30		30	
32	32.5		33		33.5		33.5	
40	37		37.5		38		38	

\* ( ): Values for long strokes

Note) Adjust the auto switch after confirming the operating conditions in the actual setting.

## Minimum Auto Switch Mounting Stroke

Auto switch model	n: No. of auto switches (mm)				
	No. of auto switches mounted				
	1	2		n	
		Different surfaces	Same surface	Different surfaces	Same surface
<b>D-M9□</b>	5	15 <small>Note 1)</small>	40 <small>Note 1)</small>	$20 + 35 \frac{(n-2)}{2}$ <small>(n = 2, 4, 6...)<small>Note 3)</small></small>	$55 + 35 (n-2)$ <small>(n = 2, 3, 4, 5...)</small>
<b>D-M9□W</b>	10	15 <small>Note 1)</small>	40 <small>Note 1)</small>	$20 + 35 \frac{(n-2)}{2}$ <small>(n = 2, 4, 6...)<small>Note 3)</small></small>	$55 + 35 (n-2)$ <small>(n = 2, 3, 4, 5...)</small>
<b>D-M9□A</b>	10	25	40 <small>Note 1)</small>	$25 + 35 \frac{(n-2)}{2}$ <small>(n = 2, 4, 6...)<small>Note 3)</small></small>	$60 + 35 (n-2)$ <small>(n = 2, 3, 4, 5...)</small>
<b>D-A9□</b>	5	15	30 <small>Note 1)</small>	$15 + 35 \frac{(n-2)}{2}$ <small>(n = 2, 4, 6...)<small>Note 3)</small></small>	$50 + 35 (n-2)$ <small>(n = 2, 3, 4, 5...)</small>
<b>D-M9□V</b>	5	20	35	$20 + 35 \frac{(n-2)}{2}$ <small>(n = 2, 4, 6...)<small>Note 3)</small></small>	$35 + 35 (n-2)$ <small>(n = 2, 3, 4, 5...)</small>
<b>D-A9□V</b>	5	15	25	$15 + 35 \frac{(n-2)}{2}$ <small>(n = 2, 4, 6...)<small>Note 3)</small></small>	$25 + 35 (n-2)$ <small>(n = 2, 3, 4, 5...)</small>
<b>D-M9□WV</b> <b>D-M9□AV</b>	10	20	35	$20 + 35 \frac{(n-2)}{2}$ <small>(n = 2, 4, 6...)<small>Note 3)</small></small>	$35 + 35 (n-2)$ <small>(n = 2, 3, 4, 5...)</small>
<b>D-C7□</b> <b>D-C80</b>	5	20	60	$20 + 45 \frac{(n-2)}{2}$ <small>(n = 2, 4, 6...)<small>Note 3)</small></small>	$60 + 45 (n-2)$ <small>(n = 2, 3, 4, 5...)</small>
<b>D-H7□</b> <b>D-H7□W</b> <b>D-H7BA</b> <b>D-H7NF</b>	10	25	70	$25 + 45 \frac{(n-2)}{2}$ <small>(n = 2, 4, 6...)<small>Note 3)</small></small>	$70 + 45 (n-2)$ <small>(n = 2, 3, 4, 5...)</small>
<b>D-C73C</b> <b>D-C80C</b> <b>D-H7C</b>	5	30	80	$30 + 50 \frac{(n-2)}{2}$ <small>(n = 2, 4, 6...)<small>Note 3)</small></small>	$80 + 50 (n-2)$ <small>(n = 2, 3, 4, 5...)</small>
<b>D-B5□</b> <b>D-B64</b> <b>D-G5□</b> <b>D-K59□</b>	5	25	70	$25 + 50 \frac{(n-2)}{2}$ <small>(n = 2, 4, 6...)<small>Note 3)</small></small>	$70 + 50 (n-2)$ <small>(n = 2, 3, 4, 5...)</small>
<b>D-B59W</b>	10	30	75	$30 + 50 \frac{(n-2)}{2}$ <small>(n = 2, 4, 6...)<small>Note 3)</small></small>	$75 + 50 (n-2)$ <small>(n = 2, 3, 4, 5...)</small>

Note 3) When "n" is an odd number, an even number that is one larger than this odd number is used for the calculation.

### Note 1) Auto switch mounting

Auto switch model	With 2 auto switches	
	Different surfaces	Same surface
	<p>The proper auto switch mounting position is 3.5 mm inward from the switchholder edge.</p>	<p>The auto switch is mounted by slightly displacing it in a direction (cylinder tubecircumferential exterior) so that the auto switch and lead wire do not interfere with each other.</p>
<b>D-M9□</b> <b>D-M9□W</b>	Less than 20 stroke <small>Note 2)</small>	Less than 55 stroke <small>Note 2)</small>
<b>D-M9□A</b>	Less than 20 stroke <small>Note 2)</small>	Less than 60 stroke <small>Note 2)</small>
<b>D-A9□</b>	—	Less than 50 stroke <small>Note 2)</small>

Note 2) Minimum stroke for mounting auto switches in the other mounting types mentioned in note 1.

# CLG1 Series Auto Switch Mounting 2

## Operating Range

Auto switch model	Bore size (mm)			
	20	25	32	40
D-A9□	7	6	8	8
D-M9□ D-M9□W	4.5	5	4.5	5.5
D-C7□/C-80 D-C73C/C-80C	8	10	9	10
D-B5□/B64 D-B59W	13	13	14	14
D-H7□/H7□W D-H7BA/H7NF	4	4	4.5	5
D-H7C	7	8.5	9	10
D-G5NT	4	4	4.5	5

\* Since the operating range is provided as a guideline including hysteresis, it cannot be guaranteed (assuming approximately  $\pm 30\%$  dispersion).  
It may vary substantially depending on an ambient environment.

## Auto Switch Mounting Bracket: Part No.

Auto switch model	Bore size (mm)			
	20	25	32	40
D-M9□(V) D-M9□W(V) D-A9□(V)	Note 1) BMA3-020 (A set of a, b, c, d)	Note 1) BMA3-025 (A set of a, b, c, d)	Note 1) BMA3-032 (A set of a, b, c, d)	Note 1) BMA3-040 (A set of a, b, c, d)
D-M9□A(V) Note 2)	BMA3-020S (A set of b, c, e, f)	BMA3-025S (A set of b, c, e, f)	BMA3-032S (A set of b, c, e, f)	BMA3-040S (A set of b, c, e, f)
D-H7□ D-H7□W D-H7NF D-C7□/C80 D-C73C/C80C	BMA2-020A (A set of c and d)	BMA2-025A (A set of c and d)	BMA2-032A (A set of c and d)	BMA2-040A (A set of c and d)
D-H7BA	BMA2-020AS (A set of c and f)	BMA2-025AS (A set of c and f)	BMA2-032AS (A set of c and f)	BMA2-040AS (A set of c and f)
D-B5□/B64 D-B59W D-G5□/K59 D-G5□W/K59W D-G5BA/G59F D-G5NT	BA-01 (A set of c and d)	BA-02 (A set of c and d)	BA-32 (A set of c and d)	BA-04 (A set of c and d)

Note 1) Since the switch bracket (made from nylon) are affected in an environment where alcohol, chloroform, methylamines, hydrochloric acid or sulfuric acid is splashed over, so it cannot be used. Please consult SMC regarding other chemicals.

Note 2) When mounting a D-M9□A(V) type auto switch, if the switch bracket is mounted on the indicator light, it may damage the auto switch. Therefore, be sure to avoid mounting the switch bracket on the indicator light.

### [Mounting screw set made of stainless steel]

The following set of mounting screws made of stainless steel is available. Use it in accordance with the operating environment. (Please order the auto switch mounting bracket separately, since it is not included.)

BBA3: For D-B5/B6/G5/K5 types

BBA4: For D-C7/C80/H7 types

Note) Refer to page 1439 for the details of BBA3.

D-H7BA/G5BA auto switches are set on the cylinder with the stainless steel screws above when shipped. When an auto switch is shipped independently, BBA3 or BBA4 is attached.

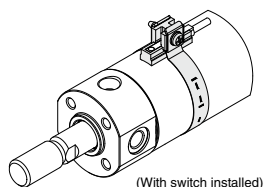
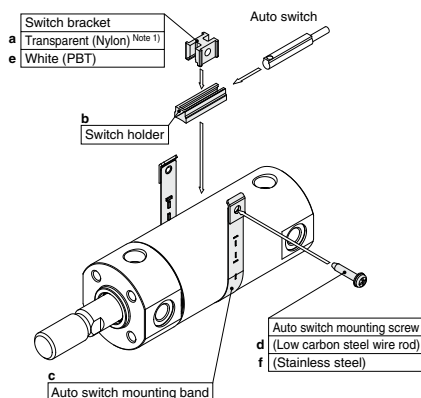



(With switch installed)

\* Band (c) is mounted so that the projected part is on the internal side (contact side with the tube).



**Cylinder Bracket/Stroke: Auto Switch Mounting Surface**

st: Stroke (mm)

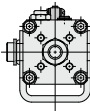
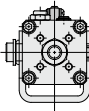
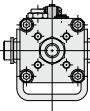
Mounting bracket	Basic, Foot, Flange, Clevis			Trunnion		
	1 (Rod cover side)	2 (Different surfaces)	2 (Same surface)	1 (Rod cover side)	2 (Different surfaces)	2 (Same surface)
No. of auto switches	1 (Rod cover side)	2 (Different surfaces)	2 (Same surface)	1 (Rod cover side)	2 (Different surfaces)	2 (Same surface)
Switch mounting surface	Port side 	Port side 	Port side 			
Switch model						
<b>D-A9□</b> <b>D-M9□</b> <b>D-M9□W</b>	10 st or more	15 to 44 st	45 st or more	10 st or more	15 to 44 st	45 st or more
<b>D-C7□/C80</b>	10 st or more	15 to 49 st	50 st or more	10 st or more	15 to 49 st	50 st or more
<b>D-H7□/H7□W</b> <b>D-H7BA/H7NF</b>	10 st or more	15 to 59 st	60 st or more	10 st or more	15 to 59 st	60 st or more
<b>D-C73C/C80C/H7C</b>	10 st or more	15 to 64 st	65 st or more	10 st or more	15 to 64 st	65 st or more
<b>D-B5□/B64/G5NT</b>	10 st or more	15 to 74 st	75 st or more	10 st or more	15 to 74 st	75 st or more
<b>D-B59W</b>	15 st or more	20 to 74 st	75 st or more	15 st or more	20 to 74 st	75 st or more

Besides the models listed in How to Order, the following auto switches are applicable.  
Refer to pages 1341 to 1435 for the detailed specifications.

Auto switch type	Part no.	Electrical entry (Fetching direction)	Features	Applicable bore size
<b>Reed</b>	D-B53, C73, C76	Grommet (In-line)	—	ø20 to ø40
	D-C80		Without indicator light	
<b>Solid state</b>	D-H7A1, H7A2, H7B		—	
	D-H7NW, H7PW, H7BW		Diagnostic indication (2-color indicator)	
	D-G5NT		With timer	

\* For solid state auto switches, auto switches with a pre-wired connector are also available. Refer to pages 1410 and 1411 for details.

\* Normally closed (NC = b contact) solid state auto switches (D-M9□E(V)) are also available. Refer to page 1360 for details.



# CL□ Series

## Specific Product Precautions 1

Be sure to read this before handling the products.

Refer to page 9 for safety instructions and pages 10 to 19 for actuator and auto switch precautions.

### Design of Equipment and Machinery

#### ⚠ Warning

- Construct so that the human body will not come into direct contact with driven objects or the moving parts of locking cylinders.  
If there is a risk of contact, provide safety measures such as a cover or a system that uses sensors that will activate an emergency stop before contact is made.
- Use a balance circuit in which lurching of the piston is taken into consideration. If the lock is applied at a desired position of a stroke and compressed air is applied to only one side of the cylinder, the piston will lurch at a high speed the moment the lock is disengaged. In such a situation, there is a risk of injury to humans, or equipment damage. To prevent the piston from lurching, use a balance circuit such as the recommended pneumatic circuit (P. 1006). If an air-hydro fine lock cylinder is used, make sure to operate the lock portion through air pressure.

### Selection

#### ⚠ Warning

Refer to the following criteria for the maximum load in the locked state, and set.

Holding force (maximum static load) means the maximum capability of holding a static load that is not accompanied by vibration or impact under the condition that no load is applied. Therefore, it does not refer to a load that cannot be held constantly. To ensure braking force, the maximum load must be set as described below.

- For constant static loads, such as for drop prevention:  
35% or less of the holding force (maximum static load)  
Note) For applications such as drop prevention, consider situations in which the air source is shut off, and make selections based on the holding force of the spring locked state. Do not use the pneumatic lock for drop prevention purposes.

- When kinetic energy acts upon the cylinder in a locked state, such as when effecting an intermediate stop, there are constraints in terms of the allowable kinetic energy. Therefore, refer to the allowable kinetic energy of the respective series. Furthermore, during locking, the mechanism must sustain the thrust of the cylinder itself, in addition to absorbing the kinetic energy. Therefore, even within a given allowable kinetic energy level, there is an upper limit to the amount of the load that can be sustained.

Maximum load at horizontal mounting:  
70% or less of the holding force (Maximum static load) for spring lock

Maximum load at vertical mounting: 35% or less of the holding force (Maximum static load) for spring lock

- In a locked state, do not apply impacts, strong vibrations or rotational forces. Do not apply impacts, strong vibrations or rotational forces from external sources, because this could damage or shorten the life of the lock unit.
- The locking of the fine lock cylinder is directional.  
Although it can be locked in both directions, be aware that its holding force is smaller in one of the directions.  
CLJ2/CLM2/CLG1..... Holding force at piston rod extended side decreases approx. 15%.

- To effect an intermediate stop, take the cylinder's stopping precision and overrun amount into consideration.

Because the lock is applied by mechanical means, the piston will not stop immediately in response to a stopping signal, but only after a time lag. This lag determines the amount of the overrun of the piston stroke. Thus, the range of the maximum and minimum amounts of the overrun is the stopping precision.

- Place the limit switch before the desired stopping position, only in the amount of the overrun.
- The limit switch must have a detection length (dog length) of the overrun amount +  $\alpha$ .
- For SMC's auto switches, the operating range are between 8 and 14 mm. (It varies depending on a switch model.) When the overrun amount exceeds this range, self-holding of the contact should be performed at the switch load side.

\* For stopping accuracy, refer to CLJ2 series (P. 967), CLM2 series (P. 978), and CLG1 series (P. 994), respectively.

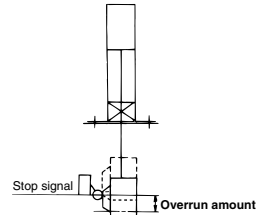

- In order to further improve stopping accuracy, the time from the stop signal to the operation of the lock should be shortened as much as possible.

To accomplish this, use a device such as a highly responsive electric control circuit or solenoid valve driven by direct current, and place the solenoid valve as close as possible to the cylinder.

- Be aware that the stopping accuracy is influenced by changes in the piston speed. The variance in the stopping position increases if the piston speed changes, such as due to load fluctuations during the reciprocal movement of the piston. Therefore, take measures to ensure a constant piston speed immediately preceding the stopping position. Furthermore, the variances in the stopping position increases when the piston is effecting a cushioning stroke or during acceleration after starting its movement.
- When unlocking is performed, if the thrust is applied to the piston, unlocking will not be easily done. To avoid that, ensure that unlocking should be performed before the thrust is applied to the piston.



# CL□ Series

## Specific Product Precautions 2

Be sure to read this before handling the products.

Refer to page 9 for safety instructions and pages 10 to 19 for actuator and auto switch precautions.

### Mounting

#### ⚠ Warning

1. Be certain to connect the rod end to the load with the lock released.
  - If this is performed with the lock engaged, a load that exceeds the allowable rotational force or holding force would be applied to the piston rod, which could damage the locking mechanism. The fine lock series cylinders have a built-in manual unlocking mechanism. Therefore, they can be maintained in the unlocked state without supplying air. However, it is recommended that the piping is connected to the unlocking port, an air pressure of 0.3 MPa or more is supplied, and the work is performed in the unlocked state.

#### ⚠ Caution

1. Do not apply offset loads on the piston rod.
  - Pay particular attention to aligning the center of gravity of the load with the axial center of the cylinder. If there is a large amount of deviation, the piston rod could become unevenly worn or damaged due to the inertial moment that is created when the piston rod is stopped by the lock.

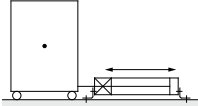

X Load center of gravity and cylinder shaft center are not matched.

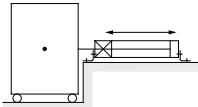

O Load center of gravity and cylinder shaft center are matched.

Note) Can be used if all of the generated moment is absorbed by an effective guide.

2. Do not turn the piston rod with the rod boot kept locked.  
When turning the piston rod, loosen the band once and do not twist the rod boot.
3. Set the breathing hole in the rod boot downward or in the direction that prevents entry of dust or water content.

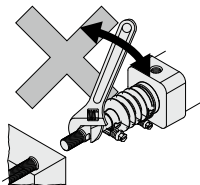

### Adjustment

#### ⚠ Caution

1. Place it in the locked position.
  - The locks are manually disengaged at the time the cylinders are shipped from the factory. Therefore, make sure to change them to the locked state before using the cylinders. For procedures to effect the change, refer to page 1007. Be aware that the lock will not operate properly if the change is not performed correctly.
  - Adjust the cylinder's air balance. In the state in which a load is attached to the cylinder, disengage the lock and adjust the air pressure at the rod side and the head side of the cylinder to obtain a load balance. By maintaining a proper air balance, the piston rod can be prevented from lurching when the lock is disengaged.
2. Adjust the mounting position of detections such as those of the auto switches. To effect an intermediate stop, adjust the mounting position of the auto switch detection by taking the amount of overrun into consideration in relation to the desired stopping position.



# CL□ Series

## Specific Product Precautions 3

Be sure to read this before handling the products.

Refer to page 9 for safety instructions and pages 10 to 19 for actuator and auto switch precautions.

### Pneumatic Circuit

#### Warning

1. Be certain to use an pneumatic circuit which will apply balancing pressure to both sides of the piston when in a locked stop.

In order to prevent cylinder lurching after a lock stop, when restarting or when manually unlocking, a circuit should be used to which will apply balancing pressure to both sides of the piston, thereby canceling the force generated by the load in the direction of piston movement.

2. The effective area of the lock release solenoid valve should be at least 50% of the effective area of the cylinder driving solenoid valve, and it should be installed as close to the cylinder as possible so that it is closer than the cylinder driving solenoid valve.

If the effective area of the lock release solenoid valve is smaller than the cylinder driving solenoid valve or if it is installed at a distance from the cylinder, the time required for exhausting air for releasing the lock will be longer, which may cause a delay in the locking operation.

The delay in the locking operation may result in problems such as increase of overrunning when performing intermediate stop or emergency stop during operation, or if maintaining position from the operation stop state such as drop prevention, workpieces may be dropped depending on the timing of the load action to the operation delay of the lock.

3. Avoid backflow of the exhaust pressure when there is a possibility of interference of exhaust air, for example for a common exhaust type valve manifold.

The lock may not operate properly when the exhaust air pressure backflows due to interference of the exhaust air when exhausting air for lock release. It is recommended to use an individual exhaust type manifold or individual valves.

4. Allow at least 0.5 seconds from a locked stop (intermediate stop of the cylinder) until release of the lock.

When the locked stop time is too short, the piston rod (and load) may lurch at a speed greater than the control speed of the speed controller.

5. When restarting, control the switching signal for the unlocking solenoid valve so that it acts before or at the same time as the cylinder drive solenoid valve.

If the signal is delayed, the piston rod (and load) may lurch at a speed greater than the control speed of the speed controller.

6. Carefully check for dew condensation due to repeated air supply and exhaust of the locking solenoid valve.

The operating stroke of the lock part is very small. So, if the piping is long and the air supply and exhaust are repeated, the dew condensation caused by the adiabatic expansion accumulates in the lock part. This may corrode internal parts, causing air leak or lock release fault.

#### 7. Basic circuit

1. [Horizontal]

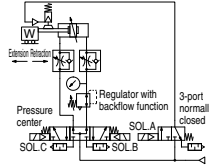

SOLA	SOLB	SOLC	Action	
ON	ON	OFF	Extension	
OFF	OFF	OFF	Locked stop	0.5 s or more
ON	OFF	OFF	Unlocked	0 to 0.5 s
ON	ON	OFF	Extension	
ON	OFF	ON	Retraction	
OFF	OFF	OFF	Locked stop	0.5 s or more
ON	OFF	OFF	Unlocked	0 to 0.5 s
ON	OFF	ON	Retraction	

2. [Vertical]

[Load in the direction of rod extension]

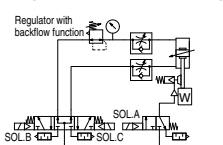

[Load in the direction of rod retraction]

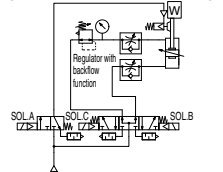

\* The symbol for the fine lock cylinder in the basic circuit uses SMC original symbol (Fine lock cylinder).

#### Caution

1. 3-position pressure center solenoid valve and regulator with backflow function can be replaced with two 3-port normally open valves and a regulator with relief function.

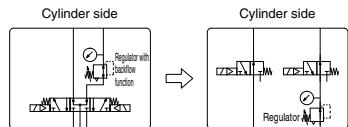

[Example]

1. [Horizontal]

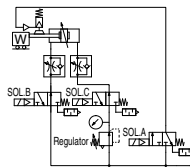

2. [Vertical]

[Load in the direction of rod extension]

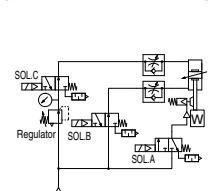

[Load in the direction of rod retraction]

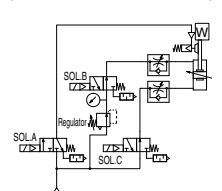

\* The symbol for the fine lock cylinder in the pneumatic circuit uses SMC original symbol (Fine lock cylinder).



## CL□ Series

# Specific Product Precautions 4

Be sure to read this before handling the products.

Refer to page 9 for safety instructions and pages 10 to 19 for actuator and auto switch precautions.

### How to Manually Disengage the Lock and Change from the Unlocked to the Locked State

The lock is manually disengaged at the time the cylinder is shipped from the factory. Because the lock will not operate in this state, make sure to change it to the locked state before operation, after having adjusted the axial center for installation.

#### How to Change from Unlocked to Locked State

- 1) Loose locking nut.
- 2) Turn the wrench flats section of the manual unlocking cam to the LOCK position that is marked on the cam guide.
- 3) While keeping the wrench flats section in place, tighten the lock nut.

Note) The manual unlocking cam will rotate approximately 180°. Do not rotate the wrench flats section excessively.

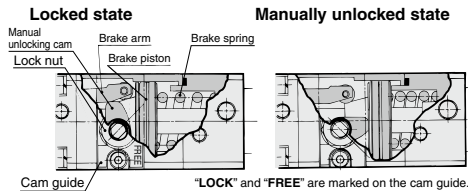

#### Manually Unlocking

The lock can be disengaged manually. However, make sure to disengage the lock pneumatically before operating the cylinder.

Note) Manual disengagement of the lock could create a greater cylinder sliding resistance than pneumatic disengagement of the lock.

- 1) Loose locking nut.
- 2) Supply air pressure of 0.3 MPa or more to the lock release port.
- 3) Turn the wrench flats section of the manual unlocking cam until it stops at the FREE position that is marked on the cam guide.
- 4) While keeping the wrench flats section in place, tighten the lock nut.

## Warning

1. **Never operate the unlocking cam until safety has been confirmed. (Do not turn to the FREE side.)**
  - When unlocking is performed with air pressure applied to only one side of the cylinder, the moving parts of the cylinder will lurch at high speed causing a serious hazard.
  - When unlocking is performed, be sure to confirm that personnel are not within the load movement range and that no other problems will occur if the load moves.
2. **Before operating the unlocking cam, exhaust any residual pressure which is in the system.**
3. **Take measures to prevent the load from dropping when unlocking is performed.**
  - Perform work with the load in its lowest position.
  - Take measures for drop prevention by strut, etc.



# Lock-up Cylinder

## CL1 Series

ø40, ø50, ø63, ø80, ø100, ø125, ø140, ø160

### Spring locking type

Discharging the unlocking air causes the lock to operate.

### Locking in one direction

- Lock direction can be changed.
- The both-direction lock type can be ordered using the made-to-order part number suffix "-X51."

#### Series Variations

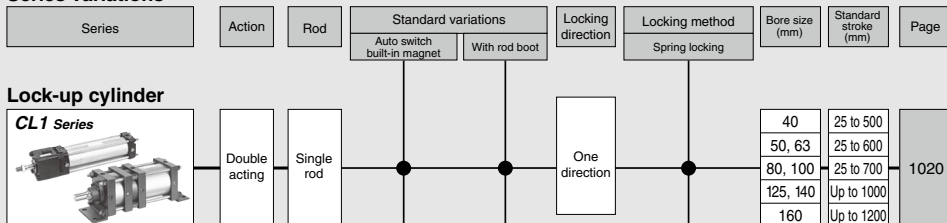

# Lock-up Cylinder

## Double Acting, Single Rod

# CL1 Series

ø40, ø50, ø63, ø80, ø100, ø125, ø140, ø160

The CL1 series lock-up cylinder is a self-locking type that contains a ring that is tilted by a spring force, which is further tilted by the load that is applied to the cylinder, thus locking the piston rod. This cylinder is suitable for intermediate stops, emergency stops, or for drop prevention.

### How to Order

**CL1 L 100 200 F - JN**

**With auto switch CDL1 L 100 200 F - JN - M9BW**

**With auto switch (Built-in magnet)**

**Mounting type**

<b>B</b>	Basic type	<b>C</b>	Single clevis type
<b>L</b>	Foot type	<b>D</b>	Double clevis type
<b>F</b>	Rod side flange type	<b>T</b>	Center trunnion type
<b>G</b>	Head side flange type		

**Auto switch**

<b>Nil</b>	Without auto switch
<b>S</b>	1 pc.
<b>n</b>	"n" pcs.

\* For the applicable auto switch model, refer to the table below.

**Number of auto switches**

**With rod boot/cushion**

Rod boot	<b>J</b>	Without rod boot
	<b>N</b>	Nylon tarpaulin
Cushion	<b>K</b>	Heat resistant tarpaulin
	<b>R</b>	Without cushion
	<b>H</b>	With rod cushion
	<b>Nil</b>	With head cushion
	<b>Nil</b>	With cushion on both ends

**Made to Order**  
Refer to page 1021 for details.

**Port thread type**

<b>Nil</b>	Rc
<b>TN</b>	NPT
<b>TF</b>	G

**Auto switch**

\* Indicate alphabetically when 2 or more symbols are applicable.

**Locked-up direction**

<b>F</b>	Piston extension locking
<b>B</b>	Piston retraction locking

**Built-in Magnet Cylinder Model**

If a built-in magnet cylinder without an auto switch is required, there is no need to enter the symbol for the auto switch.  
(Example) CDL1L40-100F

**Cylinder tube I.D.**

Symbol	Bore size	Symbol	Bore size	Symbol	Bore size
<b>40</b>	40 mm	<b>80</b>	80 mm	<b>140</b>	140 mm
<b>50</b>	50 mm	<b>100</b>	100 mm	<b>160</b>	160 mm
<b>63</b>	63 mm	<b>125</b>	125 mm		

**Cylinder stroke (mm)**  
For details, refer to page 1021.

\*1 Auto switches are not available with steel tube.

### Applicable Auto Switches/Refer to pages 1341 to 1435 for further information on auto switches.

Type	Special function	Electrical entry	Indicator light	Wiring (Output)	Load voltage		Auto switch model		Lead wire length (m)				Pre-wired connector	Applicable load				
					DC	AC	Tie-rod mounting	Band mounting	0.5 (Nil)	1 (M)	3 (L)	5 (Z)						
Solid state auto switch	—	Grommet	—	3-wire (NPN)	24 V	5 V, 12 V	—	<b>M9N</b>	●	●	●	○	—	IC circuit				
									<b>G59***</b>	●	●	●			○			
				3-wire (PNP)	—	12 V	—	<b>M9P</b>	●	●	●	○	—	—				
									<b>G5P***</b>	●	●	●			○			
				2-wire	—	100 V, 200 V	—	<b>M9B</b>	●	●	●	○	—	—				
									<b>K59***</b>	●	●	●			○			
	Terminal connector	—	12 V	—	3-wire (NPN)	—	—	<b>J51</b>	—	—	—	—	—	—				
									<b>G39C</b>	—	<b>G39</b>	—			—	—		
	Diagnostic indication (2-color indicator)	—	Grommet	Yes	3-wire (NPN)	24 V	5 V, 12 V	—	<b>M9NW</b>	●	●	●	○	—	IC circuit			
										<b>K59***</b>	●	●	●			○		
					3-wire (PNP)	—	12 V	—	<b>M9PW</b>	●	●	●	○	—	—			
										<b>G5PW***</b>	●	●	●			○		
2-wire					—	100 V, 200 V	—	<b>M9BW</b>	●	●	●	○	—	—				
									<b>K59W***</b>	●	●	●			○			
Water resistant (2-color indicator)	—	Grommet	—	3-wire (NPN)	24 V	5 V, 12 V	—	<b>M9NA*1</b>	○	○	○	○	—	—				
									<b>M9PA*1</b>	○	○	○			○			
With diagnostic output (2-color indicator)	—	Terminal connector	Yes	3-wire (PNP)	—	12 V	—	<b>M9BA*1</b>	○	○	○	○	—	—				
									<b>G5BA***</b>	○	○	○			○			
Magnetic field resistant (2-color indicator)	—	Grommet	—	4-wire (NPN)	24 V	5 V, 12 V	—	<b>F59F</b>	●	●	●	○	—	IC circuit				
									<b>G59F***</b>	●	●	●			○			
Reed auto switch	—	Grommet	No/Yes/No/Yes	3-wire (NPN non-polar)	24 V	12 V	—	<b>P4DW**</b>	●	●	●	○	—	IC circuit				
									<b>A96**</b>	●	●	●			○			
				2-wire	—	100 V	—	<b>A93**</b>	●	●	●	○	—	—				
									<b>A90**</b>	●	●	●			○			
				Terminal connector	—	100 V or less	—	<b>A54</b>	●	●	●	○	—	IC circuit				
									<b>B54***</b>	●	●	●			○			
				DIN terminal	—	100 V, 200 V	—	<b>A64</b>	●	●	●	○	—	—				
									<b>A33C***</b>	—	<b>A33</b>	—			—			
				Grommet	—	200 V or less	—	<b>A44C***</b>	—	—	—	—	—	—				
									<b>A34C***</b>	—	<b>A34</b>	—			—			
				Diagnostic indication (2-color indicator)	—	Grommet	—	2-wire (Non-polar)	24 V	100 V, 200 V	—	<b>A59W</b>	●	●	●	○	—	Relay, PLC
													<b>B59W***</b>	●	●	●		

\*1 Water resistant type auto switches can be mounted on the above models, but in such case SMC cannot guarantee water resistance. Consult with SMC regarding water resistant types with the above model numbers.

\* Lead wire length symbols: 0.5 m ..... Nil (Example) M9NW

1 m ..... M (Example) M9NM

3 m ..... L (Example) M9NL

5 m ..... Z (Example) M9NZ

\* Solid state auto switches marked with "○" are produced upon receipt of order.

\*\* D-A□/A9□ cannot be mounted on ø50.

\*\*\* The following auto switches cannot be mounted on ø125 to ø160.

D-G39C, K39C, A33C, A44C, G5□, K59, G5□W, K59W, G5BA, G59F, G5NT, B5□, B64, B59W, P4DW.

\* Since there are other applicable auto switches than listed, refer to page 1040 for details.

\* For details about auto switches with pre-wired connector, refer to pages 1410 and 1411.

\* D-A□/M□□/MS□□/MS□□A auto switches are shipped together (not assembled). (Only auto switch mounting brackets for the models listed above are assembled at the time of shipment.)



# Lock-up Cylinder Double Acting, Single Rod **CL1 Series**

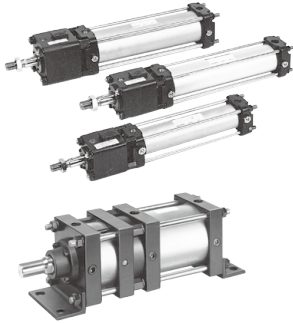

**Symbol**  
Air cushion

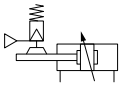

**Made to Order: Individual Specifications**  
(For details, refer to page 1041.)

Symbol	Specifications
-X51	Both-directions lock-up cylinder

**Made to Order Specifications**  
[Click here for details](#)

Symbol	Specifications
-XA□	Change of rod end shape
-XC3	Special port location
-XC14	Change of trunnion bracket mounting position (ø40 to 100 only)

## Lock-up Unit Specifications

Lock operation	Spring lock
Lock-up release pressure	0.2 MPa or more (at no load)
Lock-up start pressure	0.05 MPa or less
Lock-up direction	One direction (Lock direction can be changed.)

## Stopping Accuracy

(Not including tolerance of control system)

Piston speed	Bore size (mm)	
	40 to 100	125 to 160
50 mm/s	± 0.6 mm	± 1 mm
100 mm/s	± 1.2 mm	± 2 mm
200 mm/s	± 2.3 mm	± 3 mm

## Lock-up Unit Model

Applicable bore size (mm)	40	50	63	80	100
Lock-up unit part no.	CL-40	CL-50	CL-63	CL-80	CL-100

Refer to pages 1034 to 1040 for cylinders with auto switches.

- Minimum auto switch mounting stroke
- Proper auto switch mounting position (detection at stroke end) and mounting height
- Operating range
- Switch mounting bracket: Part no.

## Specifications

Bore size (mm)	ø40 to ø100	ø125 to ø160
Proof pressure	1.5 MPa	1.57 MPa
Maximum operating pressure	1.0 MPa	
Minimum operating pressure	0.08 MPa	
Piston speed	50 to 200 mm/s*	
Ambient and fluid temperature	Without auto switch -10 to 70°C With auto switch -10 to 60°C (No freezing)	Without auto switch 0 to 70°C With auto switch 0 to 60°C (No freezing)
Lubrication	Not required (Non-lube)	
Cushion	Air cushion	
Stroke length tolerance	Up to 250 <sup>+1.0</sup> <sub>0</sub> 251 to 1000 <sup>+1.4</sup> <sub>0</sub> 1001 to 1500 <sup>+1.8</sup> <sub>0</sub> 1501 to 1600 <sup>+2.2</sup> <sub>0</sub>	
Mounting	Basic type, Axial foot type, Rod side flange type Head side flange type, Single clevis type Double clevis type, Center trunnion type	

\* Make sure to operate the cylinder in such a way that the piston speed does not exceed 200 mm/s during locking.

\* The maximum speed of 500 mm/s can be accommodated if the piston is to be locked in the stationary state for the purpose of drop prevention.

## Max. Load and Lock Holding Force (Max. static load)

Bore size (mm)	40	50	63	80	100	125	140	160	
Max. load (N)	Horizontal Mounting	588	981	1470	2450	3820	6010	7540	9850
	Vertical Mounting	294	490	735	1230	1910	3000	3770	4920
Holding force (Max. static load) (N)*	1230	1920	3060	4930	7700	12100	15100	19700	

\* The holding force (max. static load) indicates the maximum capability to hold a static load without loads, vibration or impact. This does not indicate a load that can be held in ordinary conditions. The maximum load is limited depending on the mounting orientation. Refer to the CL series Specific Product Precautions 1 on page 1043 for selecting cylinders.

## Cylinder Stroke (ø40 to ø100)/

Refer to the minimum auto switch mounting stroke (pages 1034 and 1036) for those with an auto switch.

Bore size (mm)	Standard stroke (mm)	Long stroke (L, F only)
40	25, 50, 75, 100, 125, 150, 175, 200, 250, 300, 350, 400, 450, 500	800
50, 63	25, 50, 75, 100, 125, 150, 175, 200, 250, 300, 350, 400, 450, 500, 600	1200
80, 100	25, 50, 75, 100, 125, 150, 175, 200, 250, 300, 350, 400, 450, 500, 600, 700	ø80: 1400, ø100: 1500

Note 1) Strokes other than listed above are produced upon receipt of order. Spacers are not used for intermediate strokes.

Note 2) Long strokes are applicable for the axial foot and rod side flange types. If other mounting brackets are used or the length exceeds the long stroke limit, the maximum stroke should be determined based on the stroke selection table (technical data).

## Cylinder Stroke (ø125 to ø160)

Unit: mm

Tube material	Aluminum alloy	Carbon steel piping	
Bore size (mm)	Basic type, Head side flange type, Single clevis type, Double clevis type, Center trunnion type, Foot type, Rod side flange type	Basic type, Head side flange type, Single clevis type, Double clevis type, Center trunnion type,	Foot type, Rod side flange type
125, 140	Up to 1000	Up to 1000	Up to 1600
160	Up to 1200	Up to 1200	Up to 1600

## Cylinder Stroke/

### Cylinder with Auto Switch (Built-in magnet)

Refer to the minimum auto switch mounting stroke (pages 1034 and 1036) for those with an auto switch.

Unit: mm

Bore size (mm)	Basic type, Head side flange type, Single clevis type, Double clevis type, Center trunnion type,	Foot type, Rod side flange type
125, 140	Up to 1000	Up to 1400
160	Up to 1200	Up to 1400

# CL1 Series

## Accessory

Mounting		Basic type	Foot type	Rod side flange type	Head side flange type	Single clevis type	Double clevis type	Center trunnion type
Standard products	Rod end nut *	●	●	●	●	●	●	●
	Clevis pin	—	—	—	—	—	—	—
Option	Single knuckle joint	●	●	●	●	●	●	●
	Double knuckle joint (with pin)	●	●	●	●	●	●	●
	Rod boot	●	●	●	●	●	●	●

\* ø125 to ø160: Option

## Rod Boot Material

Symbol	Rod boot material	Max. ambient temperature
J	Nylon tarpaulin	70°C
K	Heat resistant tarpaulin	110°C*

\* Maximum ambient temperature for the rod boot itself.

## Weight

(kg)

Tubing Material		Aluminum tube							
Bore size (mm)		40	50	63	80	100	125	140	160
Locked-up unit mass		0.76	1.23	2.05	3.04	4.40	16.93	21.46	32.31
Basic weight	Basic type	1.66	2.55	4.12	6.56	9.49	30.88	38.25	55.72
	Foot type	1.83	2.75	4.42	7.36	10.43	32.21	40.83	59.09
	Rod side flange type	2.06	3.15	5.08	8.40	11.81	33.65	43.28	60.95
	Head side flange type	2.09	3.29	5.16	8.51	12.06	34.35	44.32	62.98
	Single clevis type	1.93	3.00	4.88	7.94	11.80	36.02	45.46	65.45
	Double clevis type	1.92	2.98	4.90	7.94	11.82	35.83	45.17	64.28
Trunnion type		2.26	3.30	5.47	8.90	13.02	35.77	46.09	63.86
Additional weight per each 100 mm of stroke		0.44	0.56	0.74	1.04	1.30	1.77	1.90	2.39
Accessory bracket	Single knuckle	0.23	0.26	0.26	0.66	0.83	0.91	1.16	1.56
	Double knuckle (with pin)	0.37	0.43	0.43	0.87	1.27	1.37	1.81	2.48

Calculation: (Example) **CL1L125-500F**

- Basic weight ..... 32.21 (ø125, Foot type)
- Additional weight .... 1.77/100 st  
32.21 + 1.77/100 x 500 = 41.06 kg

\* Add the lock-up unit weight for ø40 to ø100 and ø125 to ø160 steel tubes to the cylinder unit weight of CA2 and CS1 series listed in the **Web Catalog**.

## Mounting Bracket Part No.

Bore size (mm)		40	50	63	80	100	125	140	160
Foot type *	Rod side	CA-L04	CA-L05	CA-L06	CA-L08	CA-L10	CS1-L12	CS1-L14	CS1-L16
	Head side	CA1-L04	CA1-L05	CA1-L06	CA1-L08	CA1-L10			
Rod side flange type **		CA-F04	CA-F05	CA-F06	CA-F08	CA-F10	CS1-FL12	CS1-FL14	CS1-FL16
Head side flange type		CA1-F04	CA1-F05	CA1-F06	CA1-F08	CA1-F10	CS1-F12	CS1-F14	CS1-F16
Single clevis		CA1-C04	CA1-C05	CA1-C06	CA1-C08	CA1-C10	CS1-C12	CS1-C14	CS1-C16
Double clevis ***		CA1-D04	CA1-D05	CA1-D06	CA1-D08	CA1-D10	CS1-D12	CS1-D14	CS1-D16

\* When ordering foot bracket for 1 cylinder, order 1 foot bracket each for the rod side and the head side for ø40 to ø100 and 2 foot brackets for ø125 to ø160.

\*\* The ø125 to ø160 rod side flange types use the long stroke flanges of the CS1 series.

\*\*\* Clevis pin, plain washer and cotter pin are shipped together with double clevis type.

## Construction Principle

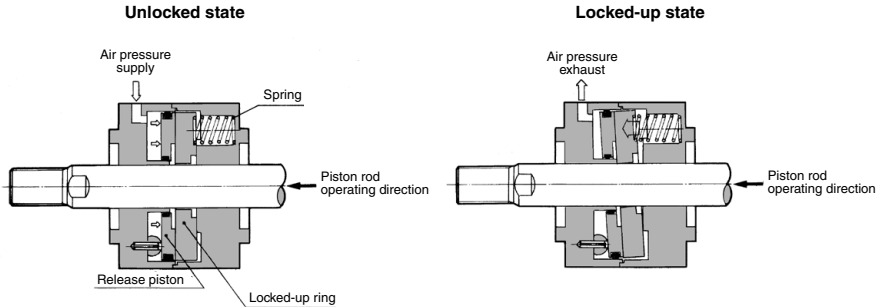

## ⚠ Caution Caution on Changing the Lock-up Direction

### ø40 to ø100

The lock-up is unidirectional. However, the lock-up direction can be changed easily. To change the direction, pay particular attention to the following steps:

Loosening the tie-rods for the purpose of changing the direction could also loosen the nuts on the cylinder side. Therefore, before assembling the unit, make sure to verify that the nuts on the cylinder are not loose. Retighten the nuts if they are loose, and while turning the piston rod, apply a low pressure of 0.08 MPa to make sure that it operates smoothly in both the extending and retracting directions.

1. Loosen the tie-rod nuts and pull out the four tie-rods.

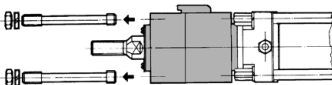

2. Open the rubber cap and screw in the unlocking bolt, which is provided as an accessory part. At this time, apply air pressure of 0.2 MPa to 0.3 MPa to disengage the lock and insert the bolt. (The operation to follow can be performed properly and easily with the application of air pressure.) After verifying that the bolt has been inserted properly, pull out the unit from the rod. Then, loosen the three screws in the scraper presser plate to remove the scraper plate and the scraper. Install the scraper and the presser plate, in that order, on the opposite side.

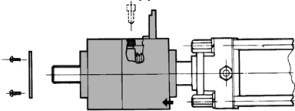

3. Turn the unit to the opposite end so that the end without the scraper is facing the cylinder rod cover. Then, securely insert the unit into the end boss portion of the rod cover.
4. Install four tie-rods, with their shorter threaded portion oriented towards the rod cover, and tighten them with uniform torque. Until the installation and adjustment have been completed, never pull out the unlocking bolt (or release the air pressure).

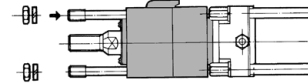

The processes described above complete the changing of the locked-up direction. Before using the cylinder, make sure that the lock-up operates properly.

### ø125 to ø160

1. Loosen the tie-rod nuts and pull out the four tie-rods.

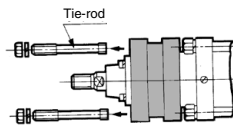

2. Apply air pressure of 0.2 MPa to 0.3 MPa to disengage the lock and pull out the lock-up unit from the piston rod.

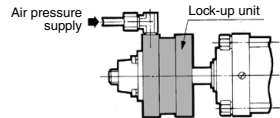

3. Remove the retainer plate from the lock-up unit and install the retainer plate on the opposite end. Reapply the air pressure, and with the end on which the retainer plate had, until now, been facing towards the cylinder, insert the locked-up unit into the piston rod and fit it into the end boss portion of the rod cover.

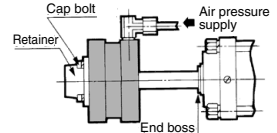

4. Install the four tie-rods, with their shorter threaded portion oriented towards the rod cover, and tighten them with uniform torque. Maintain the application of air pressure until the installation and adjustment have been completed, and never actuate the lock in the meantime.

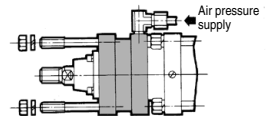

## ⚠ Caution

When the lock-up unit is not secured by the tie-rods, the air pressure applied to the lock-up port should be between 0.2 MPa and 0.3 MPa. Never supply a higher air pressure as it could lead to equipment damage.

# CL1 Series

## ⚠ Warning

1. Do not unlock manually until the safety is confirmed.
2. Perform the unlocking after the residual pressure inside the system has been exhausted.
3. Take measures to prevent the load from dropping when unlocking is performed.
  - Perform work with the load in its lowest position.
  - Take measures for drop prevention by strut, etc.

## Manual Lock Release (ø40 to ø100)

To manually disengage the lock, perform the following steps:

1. Open the rubber cap.
2. Apply 0.2 MPa to 0.3 MPa of air pressure to the locking port, and bring the tilted ring upright.
3. Screw a bolt of an appropriate length into the ring tap.  
The bolt size is M5 for ø40 and ø50, and M6 for ø63, ø80, and ø100.

## ⚠ Caution

During installation adjustment, perform the operation by applying air pressure only to the lock-up port.

## ⚠ Caution

The lock is manually disengaged at the time the cylinder is shipped from the factory. Because the lock will not operate in this state, make sure to change it to the locked state before operation, after having adjusted the axial center for installation. (Only ø40 to ø100)

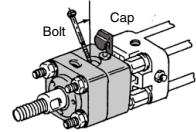

ø40 to ø100

(On cylinders ø125 to ø160, the lock cannot be disengaged manually.)

## ⚠ Caution Recommended Pneumatic Circuit/Caution on Handling

For Selection/recommended pneumatic circuit, stopping accuracy and caution on handling, refer to pages 1043 to 1046.

### ⚠ Caution

#### Stopping Accuracy

1. Load fluctuations during the reciprocal movement of the piston could cause the piston speed to change. A change in the piston speed could greatly increase the variance in the piston's stopping position. Therefore, take appropriate measures so that the piston speed becomes constant during the piston's reciprocal movement, particularly just before stopping.
2. During a cushioning stroke, or when the piston is in the acceleration region following the start of its travel, there is a large change in speed. Thus, the variance in the stopping position will also be large. Therefore, when effecting a step movement in which the stroke from the start of the operation to the next position is short, be aware of the possibility of being unable to attain the accuracy.
3. **Precautions regarding lock-up after the piston has been stopped with an external stopper:**  
To apply the lock-up after the piston has been stopped by an external stopper other than the locked-up mechanism, including stoppage by the stroke end of the cylinder, be aware of the matters described below.  
Due to the nature of the lock-up mechanism, there is an axial play of about 0.5 to 1.0 mm. Furthermore, due to pipe routing conditions, if it takes longer for the air to discharge through the lock-up port than for the balance pressure to stabilize, causing a delay in locking, the piston rod will move for an amount that is equivalent to the "play + delay".

### ⚠ Caution

#### Caution on Handling

1. **Flushing**  
Before piping is connected, it should be thoroughly blown out with air (flushing) or washed to remove cutting chip, cutting oil and other debris from inside the pipe.
2. **The load on the piston rod**  
Use the cylinder in the state in which the load to the piston rod is always applied in the axial direction. This must be more strictly adhered to than with ordinary air cylinders. Furthermore, use a guide to control the movement of the load so as not to cause chatter or twist.
3. **A rotational force against the piston rod**  
Avoid applying a rotational force against the piston rod. In particular, the application of a rotational force must be prevented when in a lock-up state.
4. **Protecting the sliding portion of the rod**  
Use caution that no scratch or dent will be given to the slide part of the guide rod, as this could damage the seals and lead to leaks or faulty lock-up.
5. **Lubrication**  
It is not necessary to lubricate the CL series because it is the non-lube type. Never lubricate it because doing so will cause faulty lock-up.

### ⚠ Caution

#### Recommended Pneumatic Circuit

For recommended pneumatic circuits, refer to page 1045.

1. **Operating the pneumatic circuit**  
Instead of the current reciprocal air cylinder circuit, use an pneumatic circuit, such as the recommended circuit, in which measures are taken to prevent the piston from lurching after the lock-up has been disengaged.
2. **Lock-up direction**  
The lock-up is unidirectional. The locking direction is in accordance with the position of the lock-up port, as shown in the figure below.

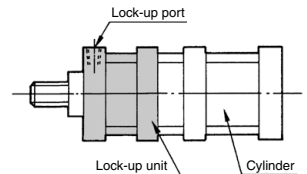

Extension locking

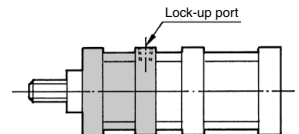

Retraction locking

ø125 to ø160

For cylinders ø40 to ø100, verify the ◀ portion that is stamped on the cap of the lock.

3. **Maximum speed and maximum load**  
Never lock up a cylinder that involves a kinetic energy that exceeds the maximum speed or the maximum load indicated in the specifications.

## Piston speed over 200 mm/s (When locking)

4. Immediately before a lock stop, drop the piston speed to 200 mm/s or lower by switching the speed controller (to the by-pass circuit). Then, operate the lock-up.

## Construction

### CL1 $\phi$ 40 to $\phi$ 100

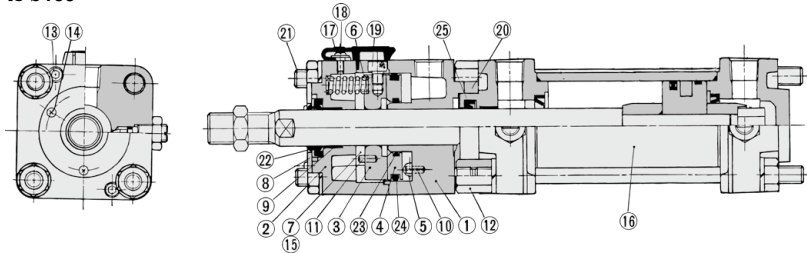

### CL1 $\phi$ 125 to $\phi$ 160

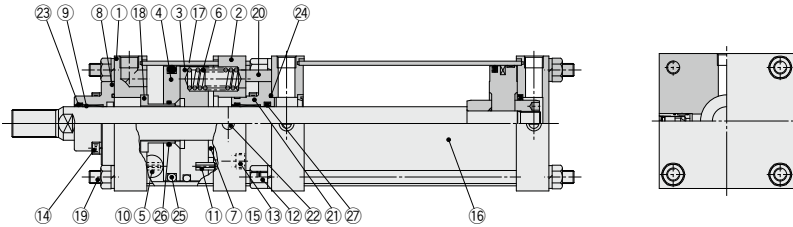

#### Component Parts: CL1 $\phi$ 40 to $\phi$ 100

No.	Description	Material	Note
1	Body	Aluminum alloy	Black painted
2	Cover	Aluminum alloy	Black painted
3	Locked-up ring	Carbon steel	Heat treated
4	Release piston	General rolled steel	Zinc chromated
5	Pivot	Carbon steel	Heat treated, zinc chromated
6	Spring	Steel wire	Zinc chromated
7	Stopper	Urethane	
8	Retaining plate	Rolled steel	Black zinc chromated
9	Bushing	Bearing alloy	
10	Spring pin	Carbon steel	
11	Spring pin for non-rotating	Carbon steel	
12	Wing nut	Rolled steel	
13	Unit fixing hex. socket head cap screw	Chromium molybdenum steel	
14	Retainer machine screw	Rolled steel	
15	Hexagon socket countersunk head screw	Chromium molybdenum steel	
16	Non lube air cylinder		CA1□N series
17	Cap	Nylon	
18	Cap screw	Rolled steel	
19	Release bolt	Chromium molybdenum steel	
20	Spacer	Aluminum alloy	Black painted
21	Unit holding tie-rod	Carbon steel	Chromated
22	Scraper	NBR	
23	O-ring	NBR	
24	O-ring	NBR	
25	Rod seal	NBR	

#### Component Parts: CL1 $\phi$ 125 to $\phi$ 160

No.	Description	Material	Note
1	Body	Rolled steel plate	Black painted
2	Cover	Rolled steel plate	Black painted
3	Locked-up ring	Carbon steel	Heat treated
4	Release piston	Rolled steel plate	Zinc chromated
5	Pivot	Carbon steel	Heat treated
6	Spring	Steel wire	Zinc chromated
7	Stopper	Urethane	
8	Retaining plate	Cast iron	Black painted
9	Bushing	Bearing alloy	—
10	Spring pin	Carbon steel	
11	Spring pin	Carbon steel	
12	Wing nut	Rolled steel	
13	Unit fixing hex. socket head cap screw	Chromium molybdenum steel	
14	Hex. socket head cap screw	Chromium molybdenum steel	
15	Hexagon socket countersunk head screw	Chromium molybdenum steel	
16	Non lube air cylinder	—	Serie CS1□N
17	Brake tube	Carbon steel tube	Inside: Hard chrome plated
18	Sleeve	Rolled steel	Zinc chromated
19	Unit holding tie-rod	Carbon steel	Chromated
20	Spacer	Rolled steel	Black painted
21	Retaining plate	Cast iron	Black painted
22	Element	Sintered metallic BC	—
23	Wiper ring	NBR	
24	Retaining plate gasket	NBR	
25	O-ring	NBR	
26	O-ring	NBR	
27	Rod seal	NBR	

#### Replacement Parts: Seal Kit

Bore size (mm)	Kit no.	Bore size (mm)	Kit no.
40	CL40-PS	100	CL100-PS
50	CL50-PS	125	CL125-PS
63	CL63-PS	140	CL140-PS
80	CL80-PS	160	CL160-PS

\* Since the lock section for CL1 series is normally replaced as a unit, kits are for the cylinder section only. These can be ordered using the order number for each bore size.

\* Seal kit includes a grease pack ( $\phi$ 40,  $\phi$ 50: 10 g,  $\phi$ 63,  $\phi$ 80: 20 g,  $\phi$ 100: 30 g,  $\phi$ 125 to  $\phi$ 160: 40 g).  
Order with the following part number when only the grease pack is needed.  
Grease pack part no.: GR-S-010 (10 g), GR-S-020 (20 g)

# CL1 Series

## Basic Type (B)

ø40 to ø100

Ⓐ Lock-up at piston forward Ⓑ Lock-up at piston backward

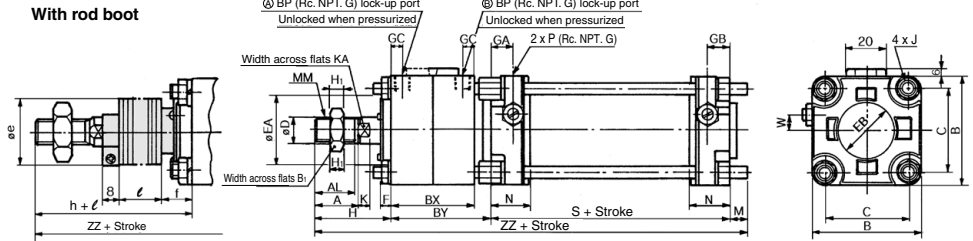

ø125 to ø160

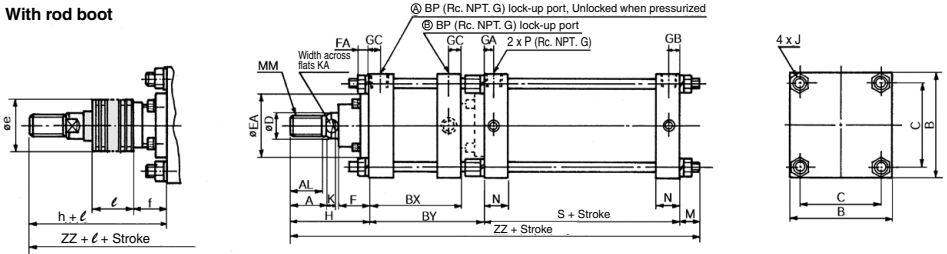

Bore size (mm)	Stroke range (mm)		A	AL	B	B <sub>1</sub>	BX	BY	BP	C	D	EA	EB	F	FA	GA	GB	GC	H <sub>1</sub>	J	K	KA
	Without rod boot	With rod boot																				
40	Up to 500	20 to 500	30	27	60	22	59	69	¼	44	16	40	32	6.5	—	15	15	11	8	M8 x 1.25	6	14
50	Up to 600	20 to 600	35	32	70	27	67	78	¼	52	20	50	40	6.0	—	17	17	11	11	M8 x 1.25	7	18
63	Up to 600	20 to 600	35	32	86	27	73	84	¼	64	20	55	40	6.0	—	17	17	11	11	M10 x 1.25	7	18
80	Up to 750	20 to 750	40	37	102	32	77	92	¼	78	25	65	52	8.0	—	21	21	11	13	M12 x 1.75	11	22
100	Up to 750	20 to 750	40	37	116	41	85	100	¼	92	30	80	52	8.0	—	21	21	11	16	M12 x 1.75	11	26
125	Up to 1000	30 to 1000	50	47	145	—	112.5	141.5	½	115	36	90	—	43	14	16	16	16	—	M14 x 1.5	15	31
140	Up to 1000	30 to 1000	50	47	161	—	121	150	½	128	36	90	—	43	14	16	16	16	—	M14 x 1.5	15	31
160	Up to 1200	30 to 1200	56	53	182	—	133	167	¾	144	40	90	—	43	14	18.5	18.5	18.5	—	M16 x 1.5	17	36

Bore size (mm)	Without rod boot			With rod boot									
	M	MM	N	P	S	W	H	ZZ	e	f	h	l	ZZ
40	11	M14 x 1.5	27	¼	84	8	51	215	36	16.5	59	¼ stroke	223
50	11	M18 x 1.5	30	⅜	90	0	58	237	45	16.0	66	¼ stroke	245
63	14	M18 x 1.5	31	⅜	98	0	58	254	45	16.0	66	¼ stroke	262
80	17	M22 x 1.5	37	½	116	0	71	296	60	18.0	80	¼ stroke	305
100	17	M26 x 1.5	40	½	126	0	72	315	60	18.0	81	¼ stroke	324
125	27	M30 x 1.5	35	½	98	—	110	376.5	75	40	133	½ stroke	399.5
140	27	M30 x 1.5	35	½	98	—	110	385	75	40	133	½ stroke	408
160	30.5	M36 x 1.5	39	¾	106	—	120	423.5	75	40	141	½ stroke	444.5

Note) In installing an air cylinder, if a hole must be made to accommodate the rod portion, make sure to machine a hole that is larger than the boot outer diameter "øe".

**Axial Foot Type (L)**

ø40 to ø100

Ⓐ Lock-up at piston forward Ⓑ Lock-up at piston backward

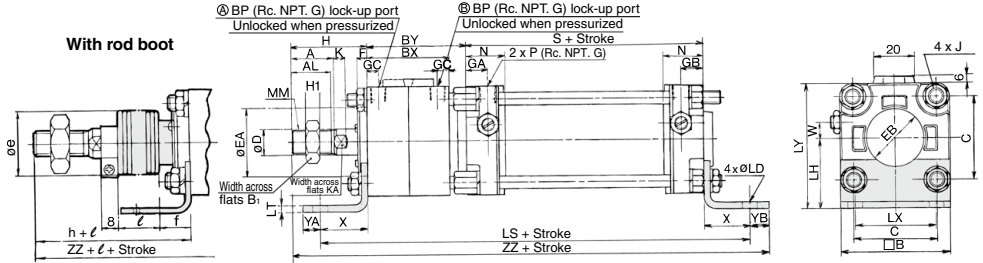

Long stroke

ø50 to ø100

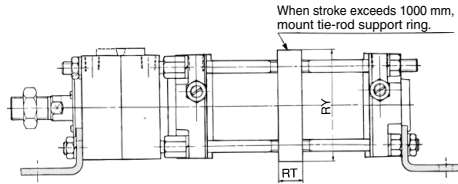

**Long Stroke**

Bore size (mm)	Stroke range (mm)	RT	RY
40	501 to 800	—	—
	601 to 1000	—	—
50	1001 to 1200	30	76
	601 to 1000	—	—
63	1001 to 1200	40	92
	701 to 1000	—	—
80	1001 to 1400	45	112
	701 to 1000	—	—
100	1001 to 1500	50	136
125	1401 to 1600	36	164
140	1401 to 1600	36	184
160	1401 to 1600	40	204

(Note) ø125 to ø160 with auto switch type is not available.

ø125 to ø160

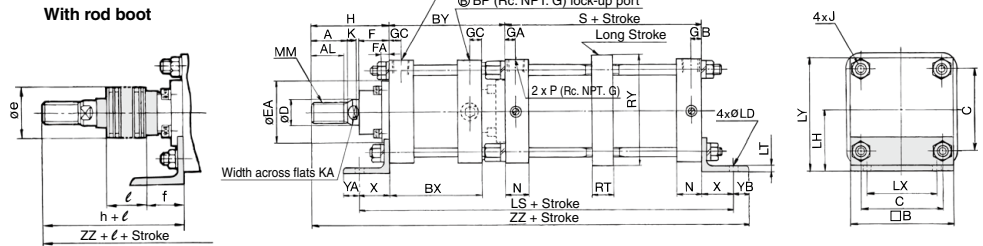

Bore size (mm)	Stroke range (mm)		A	AL	B	B <sub>1</sub>	BX	BY	BP	C	D	EA	EB	F	FA	GA	GB	GC	H <sub>1</sub>	J	K	KA	LD	LY
	Without rod boot	With rod boot																						
40	Up to 500	20 to 500	30	27	60	22	59	69	1/4	44	16	40	32	6.5	—	15	15	11	8	M8 x 1.25	6	14	9	40
	Up to 600	20 to 600	35	32	70	27	67	78	1/4	52	20	50	40	6.0	—	17	17	11	11	M8 x 1.25	7	18	9	45
63	Up to 600	20 to 600	35	32	86	27	73	84	1/4	64	20	55	40	6.0	—	17	17	11	11	M10 x 1.25	7	18	11.5	50
	Up to 750	20 to 750	40	37	102	32	77	92	1/4	78	25	65	52	8.0	—	21	21	11	13	M12 x 1.75	11	22	13.5	65
100	Up to 750	20 to 750	40	37	116	41	85	100	1/4	92	30	80	52	8.0	—	21	21	11	16	M12 x 1.75	11	26	13.5	75
	Up to 1400	30 to 1400	50	47	145	—	112.5	141.5	1/2	115	36	90	—	43	14	16	16	16	—	M14 x 1.5	15	31	19	85
140	Up to 1400	30 to 1400	50	47	161	—	121	150	1/2	128	36	90	—	43	14	16	16	16	—	M14 x 1.5	15	31	19	100
	Up to 1400	30 to 1400	56	53	182	—	133	167	3/4	144	40	90	—	43	14	18.5	18.5	18.5	—	M16 x 1.5	17	36	19	106

Bore size (mm)	LS	LT	LX	LY	MM	N	P	S	W	X	YA	YB	Without rod boot				With rod boot			
													H	ZZ	e	f	h	h	l	ZZ
40	207	3.2	42	70	M14 x 1.5	27	1/4	84	8	27	13	13	51	244	36	16.5	59	1/4 stroke	252	
	222	3.2	50	80	M18 x 1.5	30	3/8	90	0	27	13	13	58	266	45	16.0	66	1/4 stroke	274	
63	250	3.2	59	93	M18 x 1.5	31	3/8	98	0	34	16	16	58	290	45	16.0	66	1/4 stroke	298	
	296	4.5	76	116	M22 x 1.5	37	1/2	116	0	44	21	16	71	339	60	18.0	80	1/4 stroke	348	
80	312	6.0	92	133	M22 x 1.5	40	1/2	126	0	43	22	17	72	358	60	18.0	81	1/4 stroke	367	
	325	8	100	157.5	M30 x 1.5	35	1/2	98	—	45	20	20	110	445	75	40	133	1/5 stroke	437.5	
140	338	9	112	180.5	M30 x 1.5	35	1/2	98	—	45	30	30	110	433	75	40	133	1/5 stroke	456	
	373	9	118	197	M36 x 1.5	39	3/4	106	—	50	25	25	120	468	75	40	141	1/5 stroke	489	

# CL1 Series

## Head Side Flange Type (G)

ø40 to ø100

Ⓐ Lock-up at piston forward Ⓑ Lock-up at piston backward

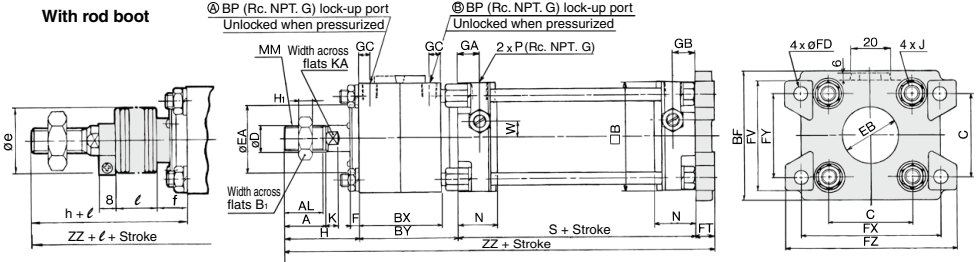

ø125 to ø160

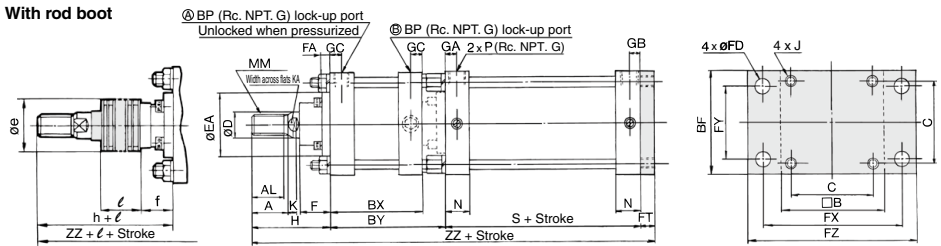

Bore size (mm)	Stroke range (mm)															(mm)										
	Without rod boot	With rod boot	A	AL	B	B <sub>1</sub>	BF	BP	BX	BY	C	D	EA	EB	F	FA	FD	FT	FX	FY	FZ	FV	GA	GB	GC	H <sub>1</sub>
40	Up to 500	20 to 500	30	27	60	22	71	¼	59	69	44	16	40	32	6.5	—	9.0	12	80	42	100	60	15	15	11	8
50	Up to 600	20 to 600	35	32	70	27	81	¼	67	78	52	20	50	40	6.0	—	9.0	12	90	50	110	70	17	17	11	11
63	Up to 600	20 to 600	35	32	86	27	101	¼	73	84	64	20	55	40	6.0	—	11.5	15	105	59	130	86	17	17	11	11
80	Up to 750	20 to 750	40	37	102	32	119	¼	77	92	78	25	65	52	8.0	—	13.5	18	130	76	160	102	21	21	11	13
100	Up to 750	20 to 750	40	37	116	41	133	¼	85	100	92	30	80	52	8.0	—	13.5	18	150	92	180	116	21	21	11	16
125	Up to 1000	30 to 1000	50	47	145	—	145	½	112.5	141.5	115	36	90	—	43	14	19	14	190	100	230	—	16	16	16	—
140	Up to 1000	30 to 1000	50	47	161	—	160	½	121	150	128	36	90	—	43	14	19	20	212	112	255	—	16	16	16	—
160	Up to 1200	30 to 1200	56	53	182	—	180	¾	133	167	144	40	90	—	43	14	19	20	236	118	275	—	18.5	18.5	18.5	—

Bore size (mm)	J	K	KA	MM	N	P	S	W	Without rod boot				With rod boot			
									H	ZZ	e	f	h	ℓ	ZZ	
40	M8 x 1.25	6	14	M14 x 1.5	27	¼	84	8	51	216	36	16.5	59	¼ stroke	224	
50	M8 x 1.25	7	18	M18 x 1.5	30	⅜	90	0	58	238	45	16.0	66	¼ stroke	246	
63	M10 x 1.25	7	18	M18 x 1.5	31	⅜	98	0	58	255	45	16.0	66	¼ stroke	263	
80	M12 x 1.75	11	22	M22 x 1.5	37	½	116	0	71	297	60	18.0	80	¼ stroke	306	
100	M12 x 1.75	11	26	M26 x 1.5	40	½	126	0	72	316	60	18.0	81	¼ stroke	325	
125	M14 x 1.5	15	31	M30 x 1.5	35	½	98	—	110	363.5	75	40	133	½ stroke	386.5	
140	M14 x 1.5	15	31	M30 x 1.5	35	½	98	—	110	378	75	40	133	½ stroke	401	
160	M16 x 1.5	17	36	M36 x 1.5	39	¾	106	—	120	413	75	40	141	½ stroke	434	



**Rod Side Flange Type (F)**

ø40 to ø100

Ⓐ Lock-up at piston forward Ⓑ Lock-up at piston backward

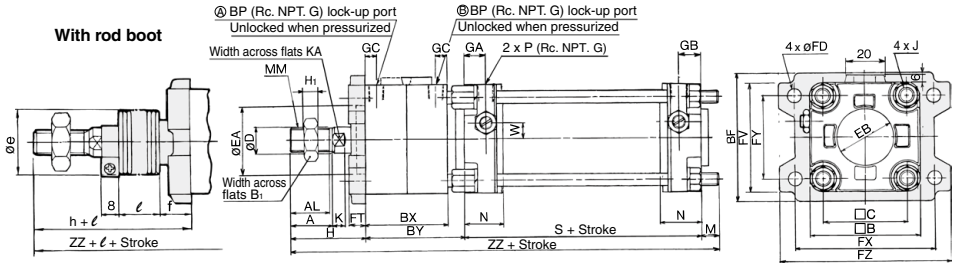

ø125 to ø160

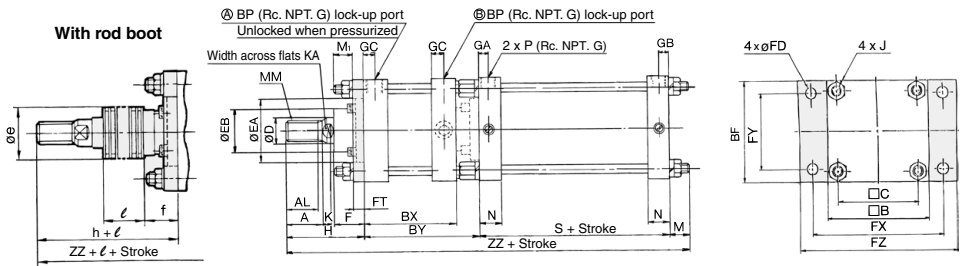

Bore size (mm)	Stroke range (mm)		Long stroke range (mm)																		
	Without rod boot	With rod boot		A	AL	B	B <sub>1</sub>	BF	BP	BX	BY	C	D	EA	EB	F	FD	FT	FX	FY	FZ
40	Up to 500	20 to 500	501 to 800	30	27	60	22	71	1/4	59	69	44	16	40	32	—	9.0	12	80	42	100
50	Up to 600	20 to 600	601 to 1000	35	32	70	27	81	1/4	67	78	52	20	50	40	—	9.0	12	90	50	110
63	Up to 600	20 to 600	601 to 1000	35	32	86	27	101	1/4	73	84	64	20	55	40	—	11.5	15	105	59	130
80	Up to 750	20 to 750	751 to 1000	40	37	102	32	119	1/4	77	92	78	25	65	52	—	13.5	18	130	76	160
100	Up to 750	20 to 750	751 to 1000	40	37	116	41	133	1/4	85	100	92	30	80	52	—	13.5	18	150	92	180
125	Up to 1400	30 to 1400	—	50	47	145	—	145	1/2	112.5	141.5	115	36	90	59	43	19	14	190	100	230
140	Up to 1400	30 to 1400	—	50	47	161	—	160	1/2	121	150	128	36	90	59	43	19	20	212	112	255
160	Up to 1400	30 to 1400	—	56	53	182	—	180	3/4	133	167	144	40	90	59	43	19	20	236	118	275

Bore size (mm)	Without rod boot																	With rod boot				
	FV	GA	GB	GC	H <sub>1</sub>	J	K	KA	M	M <sub>1</sub>	MM	N	P	S	W	H	ZZ	e	f	h	ℓ	ZZ
40	60	15	15	11	8	M8 x 1.25	6	14	11	—	M14 x 1.5	27	1/4	84	8	51	215	36	16.5	59	1/4 stroke	223
50	70	17	17	11	11	M8 x 1.25	7	18	11	—	M18 x 1.5	30	3/8	90	0	58	237	45	16.0	66	1/4 stroke	245
63	86	17	17	11	11	M10 x 1.25	7	18	14	—	M18 x 1.5	31	3/8	98	0	58	254	45	16.0	66	1/4 stroke	262
80	102	21	21	11	13	M12 x 1.75	11	22	17	—	M22 x 1.5	37	1/2	116	0	71	296	60	18.0	80	1/4 stroke	305
100	116	21	21	11	16	M12 x 1.75	11	26	17	—	M26 x 1.5	40	1/2	126	0	72	315	60	18.0	81	1/4 stroke	324
125	—	16	16	16	—	M14 x 1.5	15	31	30	22	M30 x 1.5	35	1/2	98	—	110	379.5	75	40	133	1/2 stroke	402.5
140	—	16	16	16	—	M14 x 1.5	15	31	24	19	M30 x 1.5	35	1/2	98	—	110	382	75	40	133	1/2 stroke	405
160	—	18.5	18.5	18.5	—	M16 x 1.5	17	36	26	22	M36 x 1.5	39	3/4	106	—	120	419	75	40	141	1/2 stroke	440

# CL1 Series

## Rod Side Flange Type (F)/Long Stroke

ø50 to ø100

Ⓐ Lock-up at piston forward Ⓑ Lock-up at piston backward

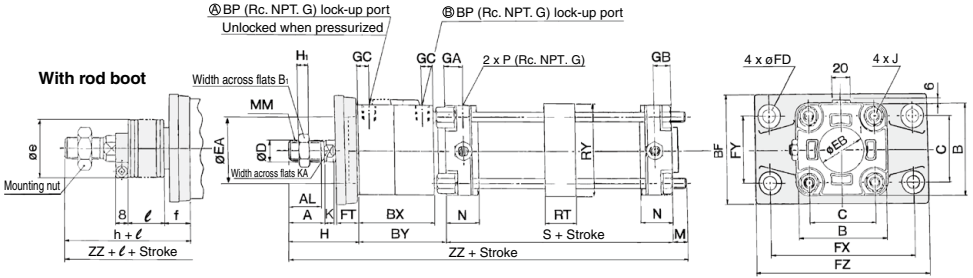

ø125 to ø160

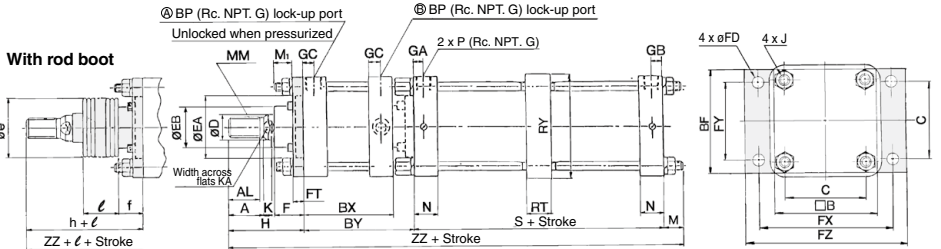

Bore size (mm)	Stroke range (mm)	A	AL	B	B <sub>1</sub>	BF	BP	BX	BY	C	D	EA	EB	F	FD	FT	FX	FY	FZ	GA	GB	GC	H <sub>1</sub>	J	K	KA
50	1001 to 1200	35	32	70	27	88	1/4	67	78	52	20	50	40	—	9.0	20	120	58	144	17	17	11	11	M8 x 1.25	7	18
63	1001 to 1200	35	32	86	27	105	1/4	73	84	64	20	55	40	—	11.5	23	140	64	170	17	17	11	11	M10 x 1.25	7	18
80	1001 to 1400	40	37	102	32	124	1/4	77	92	78	25	65	52	—	13.5	28	164	84	198	21	21	11	13	M12 x 1.75	11	22
100	1001 to 1500	40	37	116	41	140	1/4	85	100	92	30	80	52	—	13.5	29	180	100	220	21	21	11	16	M12 x 1.75	11	26
125	1401 to 1600	50	47	145	—	145	1/2	113	143	115	36	90	59	43	19	14	190	100	230	16	16	16	—	M14 x 1.5	15	31
140	1401 to 1600	50	47	161	—	160	1/2	121	150	128	36	90	59	43	19	20	212	112	255	16	16	16	—	M14 x 1.5	15	31
160	1401 to 1600	56	53	182	—	180	3/4	133	167	144	40	90	59	43	19	20	236	118	275	18.5	18.5	18.5	—	M16 x 1.5	17	36

(mm)

Bore size (mm)	Stroke range (mm)	M	M <sub>1</sub>	MM	N	P	RT	RY	S	W	Without rod boot		With rod boot				
											H	ZZ	e	f	h	l	ZZ
50	1001 to 1200	6	—	M18 x 1.5	30	3/8	30	76	90	0	67	241	45	16.0	66	1/4 stroke	240
63	1001 to 1200	10	—	M18 x 1.5	31	3/8	40	92	98	0	71	263	45	16.0	66	1/4 stroke	258
80	1001 to 1400	12	—	M22 x 1.5	37	1/2	45	112	116	0	87	307	60	18.0	80	1/4 stroke	300
100	1001 to 1500	12	—	M26 x 1.5	40	1/2	50	136	126	0	89	327	60	18.0	81	1/4 stroke	319
125	1401 to 1600	30	22	M30 x 1.5	35	1/2	36	164	98	—	110	373.5	75	40	133	1/5 stroke	402.5
140	1401 to 1600	24	19	M30 x 1.5	35	1/2	36	184	98	—	110	382	75	40	133	1/5 stroke	405
160	1401 to 1600	26	22	M36 x 1.5	39	3/4	45	204	106	—	120	419	75	40	141	1/5 stroke	440

Note) Bore size ø40 and bore sizes ø125 through ø160 with auto switch are not available.

**Single Clevis Type (C)**

ø40 to ø100

Ⓐ Lock-up at piston forward Ⓑ Lock-up at piston backward

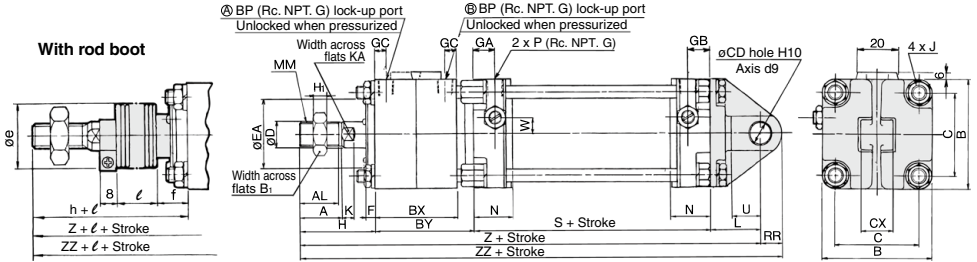

ø125 to ø160

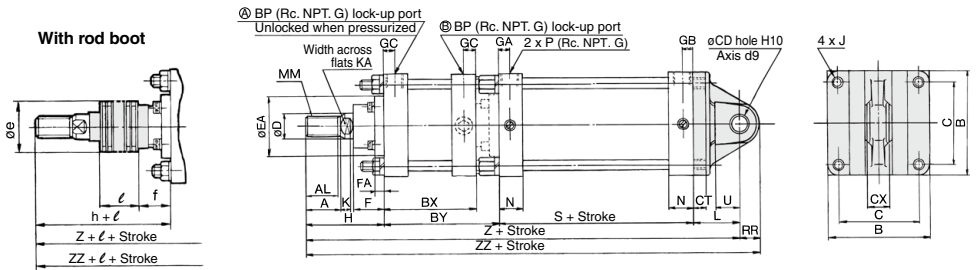

Bore size (mm)	Stroke range (mm)															(mm)					
	Without rod boot	With rod boot	A	AL	B	B <sub>1</sub>	BP	BX	BY	C	CD	CT	CX	D	EA	F	FA	GA	GB	GC	H <sub>1</sub>
40	Up to 500	20 to 500	30	27	60	22	¼	59	69	44	10	—	15.0 <sup>-0.1</sup> <sub>-0.3</sub>	16	40	6.5	—	15	15	11	8
50	Up to 600	20 to 600	35	32	70	27	¼	67	78	52	12	—	18.0 <sup>-0.1</sup> <sub>-0.3</sub>	20	50	6.0	—	17	17	11	11
63	Up to 600	20 to 600	35	32	86	27	¼	73	84	64	16	—	25.0 <sup>-0.1</sup> <sub>-0.3</sub>	20	55	6.0	—	17	17	11	11
80	Up to 700	20 to 700	40	37	102	32	¼	77	92	78	20	—	31.5 <sup>-0.1</sup> <sub>-0.3</sub>	25	65	8.0	—	21	21	11	13
100	Up to 700	20 to 700	40	37	116	41	¼	85	100	92	25	—	35.5 <sup>-0.1</sup> <sub>-0.3</sub>	30	80	8.0	—	21	21	11	16
125	Up to 1000	30 to 1000	50	47	145	—	½	112.5	141.5	115	25	17	32.0 <sup>-0.1</sup> <sub>-0.3</sub>	36	90	4.3	14	16	16	16	—
140	Up to 1000	30 to 1000	50	47	161	—	½	121	150	128	28	17	36.0 <sup>-0.1</sup> <sub>-0.3</sub>	36	90	4.3	14	16	16	16	—
160	Up to 1200	30 to 1200	56	53	182	—	¾	133	167	144	32	20	40.0 <sup>-0.1</sup> <sub>-0.3</sub>	40	90	4.3	14	18.5	18.5	18.5	—

Bore size (mm)	J	K	KA	L	MM	N	P	RR	S	U	W	Without rod boot			With rod boot					
												H	Z	ZZ	e	f	h	Z	ZZ	
40	M8 x 1.25	6	14	30	M14 x 1.5	27	¼	10	84	16	8	51	234	244	36	16.5	59	¼ stroke	242	252
50	M8 x 1.25	7	18	35	M18 x 1.5	30	⅜	12	90	19	0	58	261	273	45	16.0	66	¼ stroke	269	281
63	M10 x 1.25	7	18	40	M18 x 1.5	31	⅜	16	98	23	0	58	280	296	45	16.0	66	¼ stroke	288	304
80	M12 x 1.75	11	22	48	M22 x 1.5	37	½	20	116	28	0	71	327	347	60	18.0	80	¼ stroke	336	356
100	M12 x 1.75	11	26	58	M26 x 1.5	40	½	25	126	36	—	72	356	381	60	18.0	81	¼ stroke	365	390
125	M14 x 1.5	15	31	65	M30 x 1.5	35	½	29	98	35	—	110	414.5	443.5	75	40	133	½ stroke	437.5	466.5
140	M14 x 1.5	15	31	75	M30 x 1.5	35	½	32	98	40	—	110	433	465	75	40	133	½ stroke	456	488
160	M16 x 1.5	17	36	80	M36 x 1.5	39	¾	36	106	45	—	120	473	509	75	40	141	½ stroke	494	530

# CL1 Series

## Double Clevis Type (D)

ø40 to ø100

Ⓐ Lock-up at piston forward Ⓑ Lock-up at piston backward

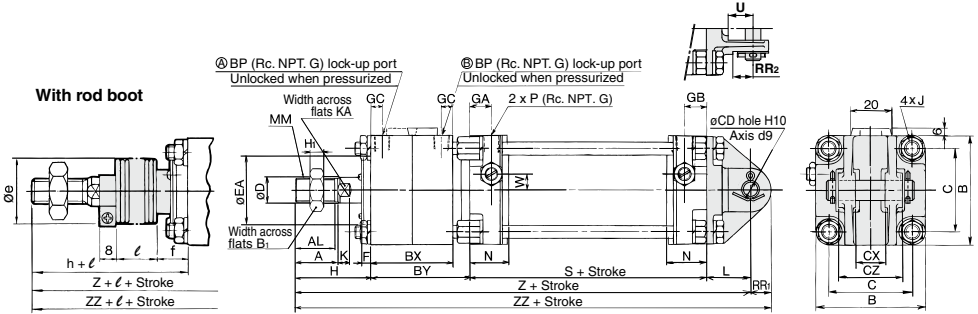

ø125 to ø160

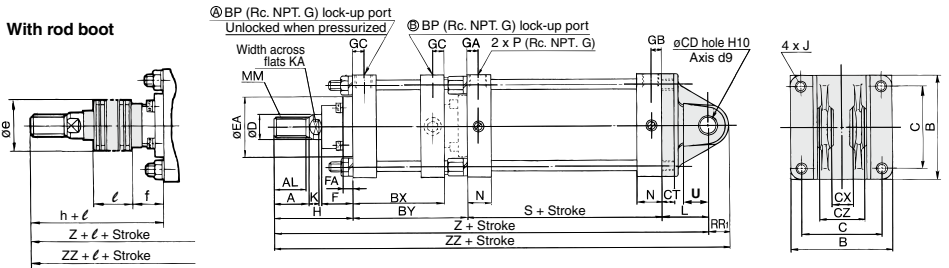

Bore size (mm)	Stroke range (mm)		A	AL	B	B <sub>1</sub>	BP	BX	BY	C	CD	CT	CX	CZ	D	EA	F	FA	GA	GB
	Without rod boot	With rod boot																		
40	Up to 500	20 to 500	30	27	60	22	¼	59	69	44	10	—	15.0 <sup>+0.3</sup> <sub>-0.1</sub>	29.5	16	40	6.5	—	15	15
50	Up to 600	20 to 600	35	32	70	27	¼	67	78	52	12	—	18.0 <sup>+0.3</sup> <sub>-0.1</sub>	38	20	50	6.0	—	17	17
63	Up to 600	20 to 600	35	32	86	27	¼	73	84	64	16	—	25.0 <sup>+0.3</sup> <sub>-0.1</sub>	49	20	55	6.0	—	17	17
80	Up to 700	20 to 700	40	37	102	32	¼	77	92	78	20	—	31.5 <sup>+0.3</sup> <sub>-0.1</sub>	61	25	65	8.0	—	21	21
100	Up to 700	20 to 700	40	37	116	41	¼	85	100	92	25	—	35.5 <sup>+0.3</sup> <sub>-0.1</sub>	64	30	80	8.0	—	21	21
125	Up to 1000	30 to 1000	50	47	145	—	½	112.5	141.5	115	25	17	32.0 <sup>+0.3</sup> <sub>-0.1</sub>	64 <sup>0</sup> <sub>-0.2</sub>	36	90	43	14	16	16
140	Up to 1000	30 to 1000	50	47	161	—	½	121	150	128	28	17	36.0 <sup>+0.3</sup> <sub>-0.1</sub>	72 <sup>0</sup> <sub>-0.2</sub>	36	90	43	14	16	16
160	Up to 1200	30 to 1200	56	53	182	—	¾	133	167	144	32	20	40.0 <sup>+0.3</sup> <sub>-0.1</sub>	80 <sup>0</sup> <sub>-0.2</sub>	40	90	43	14	18.5	18.5

Bore size (mm)	GC	H <sub>1</sub>	J	K	KA	L	MM	N	P	RR <sub>1</sub>	RR <sub>2</sub>	S	U	W	Without rod boot				With rod boot				
															H	Z	ZZ	e	f	h	ℓ	Z	ZZ
40	11	8	M8 x 1.25	6	14	30	M14 x 1.5	27	¼	10	16	84	16	8	51	234	244	36	16.5	59	¼ stroke	242	252
50	11	11	M8 x 1.25	7	18	35	M18 x 1.5	30	¾	12	19	90	19	0	58	261	273	45	16.0	66	¼ stroke	269	281
63	11	11	M10 x 1.25	7	18	40	M18 x 1.5	31	¾	16	23	98	23	0	58	280	296	45	16.0	66	¼ stroke	288	304
80	11	13	M12 x 1.75	11	22	48	M22 x 1.5	37	½	20	28	116	28	0	71	327	347	60	18.0	80	¼ stroke	336	356
100	11	16	M12 x 1.75	11	26	58	M26 x 1.5	40	½	25	23.5	126	36	0	72	356	381	60	18.0	81	¼ stroke	365	390
125	16	—	M14 x 1.5	15	31	65	M30 x 1.5	35	½	29	—	98	35	—	110	414.5	433.5	75	40	133	½ stroke	437.5	466.5
140	16	—	M14 x 1.5	15	31	75	M30 x 1.5	35	½	32	—	98	40	—	110	433	465	75	40	133	½ stroke	456	488
160	18.5	—	M16 x 1.5	17	36	80	M36 x 1.5	39	¾	36	—	106	45	—	120	473	509	75	40	141	½ stroke	494	530

\* Clevis pin, flat washer and cotter pin are attached.

**Center Trunnion Type (T)**

ø40 to ø100

Ⓐ Lock-up at piston forward Ⓑ Lock-up at piston backward

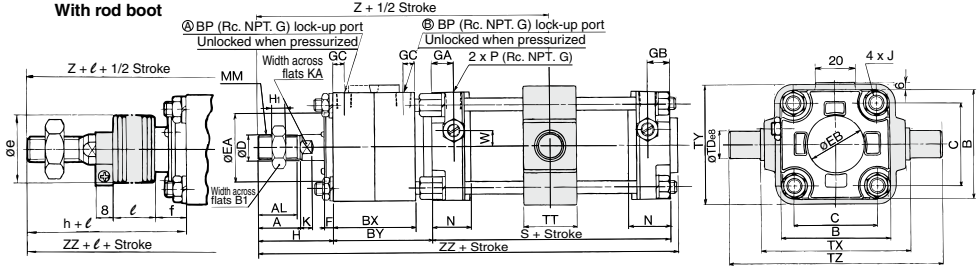

ø125 to ø160

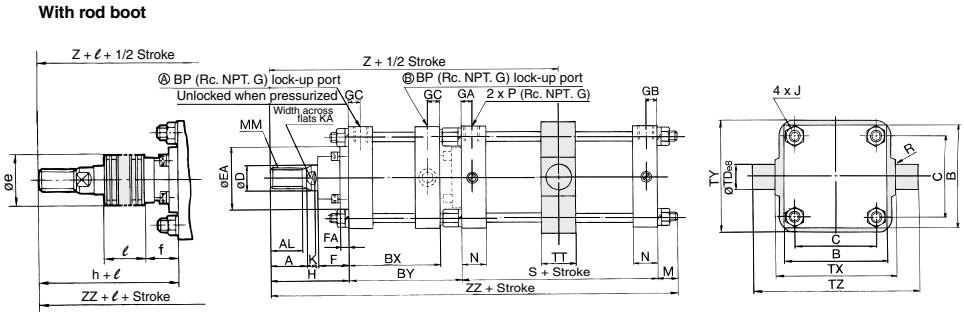

Bore size (mm)	Stroke range (mm)		A	AL	B	B <sub>1</sub>	BP	BX	BY	C	D	EA	EB	F	FA	GA	GB	GC	H <sub>1</sub>	J	K	KA
	Without rod boot	With rod boot																				
40	Up to 500	20 to 500	30	27	60	22	1/4	59	69	44	16	40	32	6.5	—	15	15	11	8	M8 x 1.25	6	14
50	Up to 600	20 to 600	35	32	70	27	1/4	67	78	52	20	50	40	6.0	—	17	17	11	11	M8 x 1.25	7	18
63	Up to 600	20 to 600	35	32	86	27	1/4	73	84	64	20	55	40	6.0	—	17	17	11	11	M10 x 1.25	7	18
80	Up to 700	20 to 700	40	37	102	32	1/4	77	92	78	25	65	52	8.0	—	21	21	11	13	M12 x 1.75	11	22
100	Up to 700	20 to 700	40	37	116	41	1/4	85	100	92	30	80	52	8.0	—	21	21	11	16	M12 x 1.75	11	26
125	25 to 1000	30 to 1000	50	47	145	—	1/2	112.5	141.5	115	36	90	—	43	14	16	16	16	—	M14 x 1.5	15	31
140	30 to 1000	30 to 1000	50	47	161	—	1/2	121	150	128	36	90	—	43	14	16	16	16	—	M14 x 1.5	15	31
160	35 to 1200	35 to 1200	56	53	182	—	3/4	133	167	144	40	90	—	43	14	18.5	18.5	18.5	—	M16 x 1.5	17	36

Bore size (mm)	M	MM	N	P	R	S	TD <sub>es</sub>	TT	TX	TY	TZ	W	Without rod boot				With rod boot				
													H	Z	ZZ	e	f	h	l	Z	ZZ
40	—	M14 x 1.5	27	1/4	—	84	15 <sup>+0.032</sup> <sub>-0.059</sub>	22	85	62	117	8	51	162	209	36	16.5	59	1/4 stroke	170	217
50	—	M18 x 1.5	30	3/8	—	90	15 <sup>+0.032</sup> <sub>-0.059</sub>	22	95	74	127	0	58	181	232	45	16.0	66	1/4 stroke	189	240
63	—	M18 x 1.5	31	3/8	—	98	18 <sup>+0.032</sup> <sub>-0.059</sub>	28	110	90	148	0	58	191	246	45	16.0	66	1/4 stroke	199	254
80	—	M22 x 1.5	37	1/2	—	116	25 <sup>+0.040</sup> <sub>-0.073</sub>	34	140	110	192	0	71	221	286	60	18.0	80	1/4 stroke	230	295
100	—	M26 x 1.5	40	1/2	—	126	25 <sup>+0.040</sup> <sub>-0.073</sub>	40	162	130	214	0	72	235	306	60	18.0	81	1/4 stroke	244	315
125	19	M30 x 1.5	35	1/2	1.0	98	32 <sup>+0.050</sup> <sub>-0.089</sub>	50	170	164	234	—	110	300.5	388.5	75	40	133	1/2 stroke	323.5	391.5
140	19	M30 x 1.5	35	1/2	1.5	98	36 <sup>+0.050</sup> <sub>-0.089</sub>	55	190	184	262	—	110	309	377	75	40	133	1/2 stroke	332	400
160	22	M36 x 1.5	39	3/4	1.5	106	40 <sup>+0.050</sup> <sub>-0.089</sub>	60	212	204	292	—	120	340	415	75	40	141	1/2 stroke	361	436

# Auto Switch Mounting 1

## Minimum Auto Switch Mounting Stroke

### Applicable Model: CDL1 Brackets for types other than the center trunnion type

n: No. of auto switches

Auto switch model	No. of auto switches mounted	Brackets for types other than the center trunnion type		
		ø40 to ø100	ø125 to ø160	
D-M9□ D-M9□W	2 (Different surfaces, same surface) 1	15	15	
	n	$15 + 40 \frac{(n-2)}{2}$ (n = 2, 4, 6, 8 ...) Note 3)	$15 + 40 \frac{(n-2)}{2}$ (n = 2, 4, 6, 8 ...) Note 3)	
D-M9□V D-M9□WV	2 (Different surfaces, same surface) 1	10	10	
	n	$10 + 30 \frac{(n-2)}{2}$ (n = 2, 4, 6, 8 ...) Note 3)	$10 + 30 \frac{(n-2)}{2}$ (n = 2, 4, 6, 8 ...) Note 3)	
D-M9□A	2 (Different surfaces, same surface) 1	15	20	
	n	$15 + 40 \frac{(n-2)}{2}$ (n = 2, 4, 6, 8 ...) Note 3)	$20 + 40 \frac{(n-2)}{2}$ (n = 2, 4, 6, 8 ...) Note 3)	
D-M9□AV	2 (Different surfaces, same surface) 1	10	15	
	n	$10 + 30 \frac{(n-2)}{2}$ (n = 2, 4, 6, 8 ...) Note 3)	$15 + 30 \frac{(n-2)}{2}$ (n = 2, 4, 6, 8 ...) Note 3)	
D-A9□	2 (Different surfaces, same surface) 1	15	15	
	n	$15 + 40 \frac{(n-2)}{2}$ (n = 2, 4, 6, 8 ...) Note 3)	$15 + 40 \frac{(n-2)}{2}$ (n = 2, 4, 6, 8 ...) Note 3)	
D-A9□V	2 (Different surfaces, same surface) 1	10	10	
	n	$10 + 30 \frac{(n-2)}{2}$ (n = 2, 4, 6, 8 ...) Note 3)	$10 + 30 \frac{(n-2)}{2}$ (n = 2, 4, 6, 8 ...) Note 3)	
D-F5□/J5□ D-F5□W/J59W D-F5BA/F59F D-A5□/A6□	2 (Different surfaces, same surface) 1	15	25	
	n	$15 + 55 \frac{(n-2)}{2}$ (n = 2, 4, 6, 8 ...) Note 3)	$25 + 55 \frac{(n-2)}{2}$ (n = 2, 4, 6, 8 ...) Note 3)	
D-F5NT	2 (Different surfaces, same surface) 1	25	35	
	n	$25 + 55 \frac{(n-2)}{2}$ (n = 2, 4, 6, 8 ...) Note 3)	$35 + 55 \frac{(n-2)}{2}$ (n = 2, 4, 6, 8 ...) Note 3)	
D-A59W	2 (Different surfaces, same surface) 1	20	25	
	n	$20 + 55 \frac{(n-2)}{2}$ (n = 2, 4, 6, 8 ...) Note 3)	$25 + 55 \frac{(n-2)}{2}$ (n = 2, 4, 6, 8 ...) Note 3)	
D-G39 D-K39 D-A3□	2 Different surfaces	35		
	Same surface	100		
	n	Different surfaces	$35 + 30(n-2)$ (n = 2, 3, 4 ...)	
		Same surface	$100 + 100(n-2)$ (n = 2, 3, 4 ...)	
1	10	15		
D-A44	2 Different surfaces	35		
	Same surface	55		
	n	Different surfaces	$35 + 30(n-2)$ (n = 2, 3, 4 ...)	
		Same surface	$55 + 50(n-2)$ (n = 2, 3, 4 ...)	
1	10	15		

Note 1) Reed auto switches D-A9□/A9□V cannot be mounted on ø50.

Note 2) The following auto switches cannot be mounted on ø125 to ø160.

D-G39C, K39C, A3□C, A44C, G5□, K59, G5□W, K59W, G5BA, G59F, G5NT, B5□, B64, B59W, P4DW.

Note 3) When "n" is an odd number, an even number that is one larger than this odd number is used for the calculation.

Auto switch model	No. of auto switches mounted	Brackets for types other than the center trunnion type		
		ø40 to ø100	ø125 to ø160	
D-G39C D-K39C D-A3□C	2 Different surfaces	20		
	Same surface	100		
	n	Different surfaces	$20 + 30(n-2)$ (n = 2, 3, 4 ...)	
		Same surface	$100 + 100(n-2)$ (n = 2, 3, 4 ...)	
1	10			
D-A44C	2 Different surfaces	20		
	Same surface	55		
	n	Different surfaces	$20 + 30(n-2)$ (n = 2, 3, 4 ...)	
		Same surface	$55 + 50(n-2)$ (n = 2, 3, 4 ...)	
1	10			
D-G5□/K59 D-G5□W D-K59W D-G5BA D-G59F D-G5NT D-B5□/B64	2 Different surfaces	15		
	Same surface	75		
	n	Different surfaces	$15 + 50(n-2)$ (n = 2, 4, 6, 8 ...) Note 3)	
		Same surface	$75 + 50(n-2)$ (n = 2, 4, 6, 8 ...) Note 3)	
1	10			
D-B59W	2 Different surfaces	20		
	Same surface	75		
	n	Different surfaces	$20 + 50(n-2)$ (n = 2, 4, 6, 8 ...) Note 3)	
		Same surface	$75 + 50(n-2)$ (n = 2, 3, 4 ...)	
1	10			
D-Y59□/Y7P D-Y7□W D-Z7□/Z80	2 (Different surfaces, same surface) 1	15		
	n	$15 + 40 \frac{(n-2)}{2}$ (n = 2, 4, 6, 8 ...) Note 3)		
D-Y69□/Y7PV D-Y7□WV	2 (Different surfaces, same surface) 1	10		
	n	$10 + 30 \frac{(n-2)}{2}$ (n = 2, 4, 6, 8 ...) Note 3)		
D-Y7BA	2 (Different surfaces, same surface) 1	20		
	n	$20 + 45 \frac{(n-2)}{2}$ (n = 2, 4, 6, 8 ...) Note 3)		
D-P4DW	2 (Different surfaces, same surface) 1	15		
	n	$15 + 65 \frac{(n-2)}{2}$ (n = 2, 4, 6, 8 ...) Note 3)		

**Minimum Auto Switch Mounting Stroke**

**Applicable Model: CDL1 Center trunnion type only**

n: No. of auto switches

Auto switch model	No. of auto switches mounted	Center trunnion type							
		ø40	ø50	ø63	ø80	ø100	ø125	ø140	ø160
D-M9□ D-M9□W	2 (Different surfaces, same surface) 1	80		85	90	95	105	110	115
	n	$80 + 40 \frac{(n-4)}{2}$ (n = 4, 8, 12, 16 ...) Note 2)		$85 + 40 \frac{(n-4)}{2}$ (n = 4, 8, 12, 16 ...) Note 2)	$90 + 40 \frac{(n-4)}{2}$ (n = 4, 8, 12, 16 ...) Note 2)	$95 + 40 \frac{(n-4)}{2}$ (n = 4, 8, 12, 16 ...) Note 2)	$105 + 40 \frac{(n-4)}{2}$ (n = 4, 8, 12, 16 ...) Note 2)	$110 + 40 \frac{(n-4)}{2}$ (n = 4, 8, 12, 16 ...) Note 2)	$115 + 40 \frac{(n-4)}{2}$ (n = 4, 8, 12, 16 ...) Note 2)
D-M9□V D-M9□WV	2 (Different surfaces, same surface) 1	55		60	65	70	80	85	90
	n	$55 + 30 \frac{(n-4)}{2}$ (n = 4, 8, 12, 16 ...) Note 2)		$60 + 30 \frac{(n-4)}{2}$ (n = 4, 8, 12, 16 ...) Note 2)	$65 + 30 \frac{(n-4)}{2}$ (n = 4, 8, 12, 16 ...) Note 2)	$70 + 30 \frac{(n-4)}{2}$ (n = 4, 8, 12, 16 ...) Note 2)	$80 + 30 \frac{(n-4)}{2}$ (n = 4, 8, 12, 16 ...) Note 2)	$85 + 30 \frac{(n-4)}{2}$ (n = 4, 8, 12, 16 ...) Note 2)	$90 + 30 \frac{(n-4)}{2}$ (n = 4, 8, 12, 16 ...) Note 2)
D-M9□A	2 (Different surfaces, same surface) 1	80		85	95	100	115		120
	n	$80 + 40 \frac{(n-4)}{2}$ (n = 4, 8, 12, 16 ...) Note 2)		$85 + 40 \frac{(n-4)}{2}$ (n = 4, 8, 12, 16 ...) Note 2)	$95 + 40 \frac{(n-4)}{2}$ (n = 4, 8, 12, 16 ...) Note 2)	$100 + 40 \frac{(n-4)}{2}$ (n = 4, 8, 12, 16 ...) Note 2)	$115 + 40 \frac{(n-4)}{2}$ (n = 4, 8, 12, 16 ...) Note 2)		$120 + 40 \frac{(n-4)}{2}$ (n = 4, 8, 12, 16 ...) Note 2)
D-M9□AV	2 (Different surfaces, same surface) 1	60		65	70	75	90		95
	n	$60 + 30 \frac{(n-4)}{2}$ (n = 4, 8, 12, 16 ...) Note 2)		$65 + 30 \frac{(n-4)}{2}$ (n = 4, 8, 12, 16 ...) Note 2)	$70 + 30 \frac{(n-4)}{2}$ (n = 4, 8, 12, 16 ...) Note 2)	$75 + 30 \frac{(n-4)}{2}$ (n = 4, 8, 12, 16 ...) Note 2)	$90 + 30 \frac{(n-4)}{2}$ (n = 4, 8, 12, 16 ...) Note 2)		$95 + 30 \frac{(n-4)}{2}$ (n = 4, 8, 12, 16 ...) Note 2)
D-A9□	2 (Different surfaces, same surface) 1	75	—	80	85	90	100	105	110
	n	$75 + 40 \frac{(n-4)}{2}$ (n = 4, 8, 12, 16 ...) Note 2)			$80 + 40 \frac{(n-4)}{2}$ (n = 4, 8, 12, 16 ...) Note 2)	$85 + 40 \frac{(n-4)}{2}$ (n = 4, 8, 12, 16 ...) Note 2)	$90 + 40 \frac{(n-4)}{2}$ (n = 4, 8, 12, 16 ...) Note 2)	$100 + 40 \frac{(n-4)}{2}$ (n = 4, 8, 12, 16 ...) Note 2)	$105 + 40 \frac{(n-4)}{2}$ (n = 4, 8, 12, 16 ...) Note 2)
D-A9□V	2 (Different surfaces, same surface) 1	50	—	55	60	65	75	80	85
	n	$50 + 30 \frac{(n-4)}{2}$ (n = 4, 8, 12, 16 ...) Note 2)			$55 + 30 \frac{(n-4)}{2}$ (n = 4, 8, 12, 16 ...) Note 2)	$60 + 30 \frac{(n-4)}{2}$ (n = 4, 8, 12, 16 ...) Note 2)	$65 + 30 \frac{(n-4)}{2}$ (n = 4, 8, 12, 16 ...) Note 2)	$75 + 30 \frac{(n-4)}{2}$ (n = 4, 8, 12, 16 ...) Note 2)	$80 + 30 \frac{(n-4)}{2}$ (n = 4, 8, 12, 16 ...) Note 2)
D-F5□/J5□ D-F5□W/J59W D-F5BA/F59F D-A5□/A6□	2 (Different surfaces, same surface) 1	90		100	110	120	125		135
	n	$90 + 55 \frac{(n-4)}{2}$ (n = 4, 8, 12, 16 ...) Note 2)		$100 + 55 \frac{(n-4)}{2}$ (n = 4, 8, 12, 16 ...) Note 2)	$110 + 55 \frac{(n-4)}{2}$ (n = 4, 8, 12, 16 ...) Note 2)	$120 + 55 \frac{(n-4)}{2}$ (n = 4, 8, 12, 16 ...) Note 2)	$125 + 55 \frac{(n-4)}{2}$ (n = 4, 8, 12, 16 ...) Note 2)		$135 + 55 \frac{(n-4)}{2}$ (n = 4, 8, 12, 16 ...) Note 2)
D-F5NT	2 (Different surfaces, same surface) 1	110		120	130	140	145		155
	n	$110 + 55 \frac{(n-4)}{2}$ (n = 4, 8, 12, 16 ...) Note 2)		$120 + 55 \frac{(n-4)}{2}$ (n = 4, 8, 12, 16 ...) Note 2)	$130 + 55 \frac{(n-4)}{2}$ (n = 4, 8, 12, 16 ...) Note 2)	$140 + 55 \frac{(n-4)}{2}$ (n = 4, 8, 12, 16 ...) Note 2)	$145 + 55 \frac{(n-4)}{2}$ (n = 4, 8, 12, 16 ...) Note 2)		$155 + 55 \frac{(n-4)}{2}$ (n = 4, 8, 12, 16 ...) Note 2)
D-A59W	2 (Different surfaces, same surface) 1	90		100	110	120	125		135
	n	$90 + 55 \frac{(n-4)}{2}$ (n = 4, 8, 12, 16 ...) Note 2)		$100 + 55 \frac{(n-4)}{2}$ (n = 4, 8, 12, 16 ...) Note 2)	$110 + 55 \frac{(n-4)}{2}$ (n = 4, 8, 12, 16 ...) Note 2)	$120 + 55 \frac{(n-4)}{2}$ (n = 4, 8, 12, 16 ...) Note 2)	$125 + 55 \frac{(n-4)}{2}$ (n = 4, 8, 12, 16 ...) Note 2)		$135 + 55 \frac{(n-4)}{2}$ (n = 4, 8, 12, 16 ...) Note 2)
D-G39 D-K39 D-A3□	2	Different surfaces	75	80	90		110		
		Same surface	100	100	100				
	n	Different surfaces	$75 + 30(n-2)$ (n = 2, 4, 6, 8 ...) Note 3)	$80 + 30(n-2)$ (n = 2, 4, 6, 8 ...) Note 3)	$90 + 30(n-2)$ (n = 2, 4, 6, 8 ...) Note 3)		$110 + 30(n-2)$ (n = 2, 4, 6, 8 ...) Note 3)		
		Same surface			$100 + 100(n-2)$ (n = 2, 4, 6, 8 ...) Note 3)				
D-A44	2	Different surfaces	75	80	90		110		
		Same surface							
	n	Different surfaces	$75 + 30(n-2)$ (n = 2, 4, 6, 8 ...) Note 3)	$80 + 30(n-2)$ (n = 2, 4, 6, 8 ...) Note 3)	$90 + 30(n-2)$ (n = 2, 4, 6, 8 ...) Note 3)		$110 + 30(n-2)$ (n = 2, 4, 6, 8 ...) Note 3)		
		Same surface	$75 + 50(n-2)$ (n = 2, 4, 6, 8 ...) Note 3)	$80 + 50(n-2)$ (n = 2, 4, 6, 8 ...) Note 3)	$90 + 50(n-2)$ (n = 2, 4, 6, 8 ...) Note 3)		$110 + 50(n-2)$ (n = 2, 4, 6, 8 ...) Note 3)		
1		75	80	90		110			

Note 1) Reed auto switches D-A9□/A9□V cannot be mounted on ø50.

Note 2) When "n" is an odd number, a multiple of 4 that is larger than this odd number is used for the calculation.

Note 3) When "n" is an odd number, an even number that is one larger than this odd number is used for the calculation.

# CL1 Series Auto Switch Mounting 2

## Minimum Auto Switch Mounting Stroke

Applicable Model: CDL1 Center trunnion type only

n: No. of auto switches

Auto switch model	No. of auto switches mounted	Center trunnion type						ø125	ø140	ø160
		ø40	ø50	ø63	ø80	ø100				
D-G39C D-K39C D-A3□C	2	Different surfaces	75	80	90					
		Same surface	100	100	100					
	n	Different surfaces	$75 + 35(n-2)$ (n = 2, 4, 6, 8 ...) <sup>Note 3)</sup>	$80 + 35(n-2)$ (n = 2, 4, 6, 8 ...) <sup>Note 3)</sup>	$90 + 35(n-2)$ (n = 2, 4, 6, 8 ...) <sup>Note 3)</sup>			—	—	—
		Same surface	$100 + 100(n-2)$ (n = 2, 4, 6, 8 ...)							
	1	75	80	90						
D-A44C	2	Different surfaces	75	80	90					
		Same surface								
	n	Different surfaces	$75 + 35(n-2)$ (n = 2, 4, 6, 8 ...) <sup>Note 3)</sup>	$80 + 35(n-2)$ (n = 2, 4, 6, 8 ...) <sup>Note 3)</sup>	$90 + 35(n-2)$ (n = 2, 4, 6, 8 ...) <sup>Note 3)</sup>			—	—	—
		Same surface	$75 + 50(n-2)$ (n = 2, 4, 6, 8 ...) <sup>Note 3)</sup>	$80 + 50(n-2)$ (n = 2, 4, 6, 8 ...) <sup>Note 3)</sup>	$90 + 50(n-2)$ (n = 2, 4, 6, 8 ...) <sup>Note 3)</sup>					
	1	75	80	90						
D-G5□/K59 D-G5□W D-K59W D-G5BA D-G59F D-G5NT D-B5□/B64 D-B59W	2	Different surfaces	90	100	110					
		Same surface								
	n	Different surfaces	$90 + 50 \frac{(n-4)}{2}$ (n = 4, 8, 12, 16 ...) <sup>Note 2)</sup>	$100 + 50 \frac{(n-4)}{2}$ (n = 4, 8, 12, 16 ...) <sup>Note 2)</sup>	$110 + 50 \frac{(n-4)}{2}$ (n = 4, 8, 12, 16 ...) <sup>Note 2)</sup>			—	—	—
		Same surface	$90 + 50(n-2)$ (n = 2, 4, 6, 8 ...) <sup>Note 3)</sup>	$100 + 50(n-2)$ (n = 2, 4, 6, 8 ...) <sup>Note 3)</sup>	$110 + 50(n-2)$ (n = 2, 4, 6, 8 ...) <sup>Note 3)</sup>					
	1	90	100	110						
D-Y59□/Y7P D-Y7□W D-Z7□/Z80	2 (Different surfaces, same surface)	80	85	90	95	105		110	115	
	n	$80 + 40 \frac{(n-4)}{2}$ (n = 4, 8, 12, 16 ...) <sup>Note 2)</sup>	$85 + 40 \frac{(n-4)}{2}$ (n = 4, 8, 12, 16 ...) <sup>Note 2)</sup>	$90 + 40 \frac{(n-4)}{2}$ (n = 4, 8, 12, 16 ...) <sup>Note 2)</sup>	$95 + 40 \frac{(n-4)}{2}$ (n = 4, 8, 12, 16 ...) <sup>Note 2)</sup>	$105 + 40 \frac{(n-4)}{2}$ (n = 4, 8, 12, 16 ...) <sup>Note 2)</sup>		$110 + 40 \frac{(n-4)}{2}$ (n = 4, 8, 12, 16 ...) <sup>Note 2)</sup>	$115 + 40 \frac{(n-4)}{2}$ (n = 4, 8, 12, 16 ...) <sup>Note 2)</sup>	
D-Y69□/Y7PV D-Y7□WV	2 (Different surfaces, same surface)	65	75	80	90		95	100		
	n	$65 + 30 \frac{(n-4)}{2}$ (n = 4, 8, 12, 16 ...) <sup>Note 2)</sup>	$75 + 30 \frac{(n-4)}{2}$ (n = 4, 8, 12, 16 ...) <sup>Note 2)</sup>	$80 + 30 \frac{(n-4)}{2}$ (n = 4, 8, 12, 16 ...) <sup>Note 2)</sup>	$90 + 30 \frac{(n-4)}{2}$ (n = 4, 8, 12, 16 ...) <sup>Note 2)</sup>		$95 + 30 \frac{(n-4)}{2}$ (n = 4, 8, 12, 16 ...) <sup>Note 2)</sup>	$100 + 30 \frac{(n-4)}{2}$ (n = 4, 8, 12, 16 ...) <sup>Note 2)</sup>		
D-Y7BA	2 (Different surfaces, same surface)	95	100	105	110		120	125		
	n	$95 + 45 \frac{(n-4)}{2}$ (n = 4, 8, 12, 16 ...) <sup>Note 2)</sup>	$100 + 45 \frac{(n-4)}{2}$ (n = 4, 8, 12, 16 ...) <sup>Note 2)</sup>	$105 + 45 \frac{(n-4)}{2}$ (n = 4, 8, 12, 16 ...) <sup>Note 2)</sup>	$110 + 45 \frac{(n-4)}{2}$ (n = 4, 8, 12, 16 ...) <sup>Note 2)</sup>		$120 + 45 \frac{(n-4)}{2}$ (n = 4, 8, 12, 16 ...) <sup>Note 2)</sup>	$125 + 45 \frac{(n-4)}{2}$ (n = 4, 8, 12, 16 ...) <sup>Note 2)</sup>		
D-P4DW	2 (Different surfaces, same surface)	120	130	140			—	—	—	
	n	$120 + 65 \frac{(n-4)}{2}$ (n = 4, 8, 12, 16 ...) <sup>Note 2)</sup>	$130 + 65 \frac{(n-4)}{2}$ (n = 4, 8, 12, 16 ...) <sup>Note 2)</sup>	$140 + 65 \frac{(n-4)}{2}$ (n = 4, 8, 12, 16 ...) <sup>Note 2)</sup>						

Note 1) The following auto switches cannot be mounted on ø125 to ø160.

D-G39C, K39C, A3□C, A44C, G5□, K59, G5□W, K59W, G5BA, G59F, G5NT, B5□, B64, B59W, P4DW.

Note 2) When "n" is an odd number, a multiple of 4 that is larger than this odd number is used for the calculation.

Note 3) When "n" is an odd number, an even number that is one larger than this odd number is used for the calculation.



**Auto Switch Proper Mounting Position (Detection at Stroke End) and Its Mounting Height**

**<Band Mounting>  $\varnothing 40$  to  $\varnothing 100$**

**D-B5□/B64  
D-B59W**

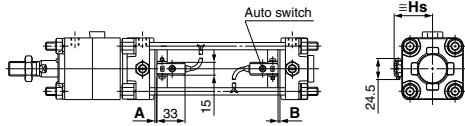

**D-A3□  
D-G39/K39**

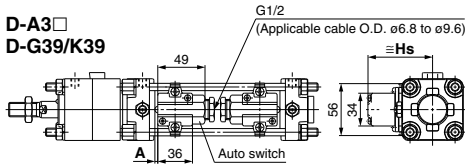

**D-G5□/K59  
D-G5□W/K59W  
D-G5BA  
D-G59F/G5NT**

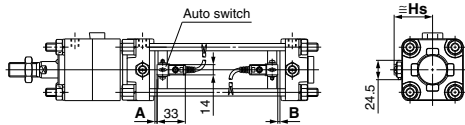

**D-A44**

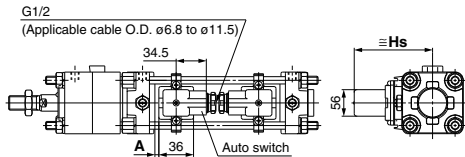

**<Tie-rod Mounting>  $\varnothing 40$  to  $\varnothing 100$**

**D-A9□/A9V      D-Z7□/Z80  
D-M9□/M9V      D-Y59□/Y69□/Y7P/Y7PV  
D-M9□W/M9□WV    D-Y7□W/Y7□WV  
D-M9□A/M9□AV    D-Y7BA**

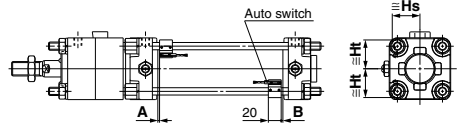

**D-A5□/A6□  
D-A59W**

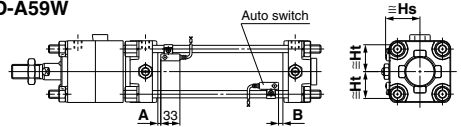

**D-A3□C  
D-G39C/K39C**

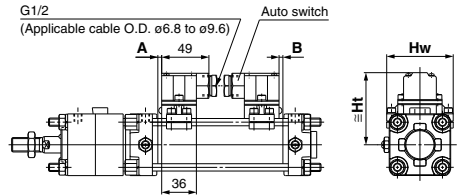

**D-F5□/J5□  
D-F5NT  
D-F5□W/J59W  
D-F5BA/F59F**

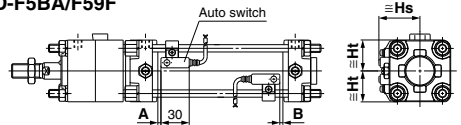

**D-A44C**

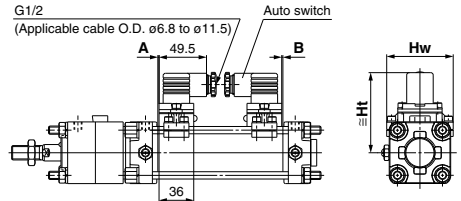

**D-P4DW**

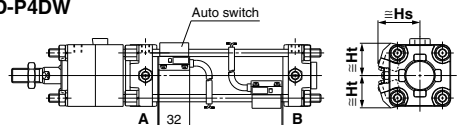



## Operating range

Auto switch model	Bore size (mm)							
	40	50	63	80	100	125	140	160
D-M9□/M9□V D-M9□W/M9□WV D-M9□A/M9□AV	4.5	5	5.5	5	6	7	6.5	6.5
D-Y59□/Y69□ D-Y7P/Y7□V D-Y7□W/Y7□WV D-Y7BA	8	7	5.5	6.5	6.5	12	13	7
D-F5□/J5□/F59F D-F5□W/J59W D-F5BA/F5NT	4	4	4.5	4.5	4.5	5	5	5.5
D-G5□/K59/G59F D-G5□W/K59W D-G5BA/G5NT	5	6	6.5	6.5	7	—	—	—
D-G39/K39	9	9	10	10	11	11	11	10
D-G39C/K39C	—	—	—	—	—	—	—	—
D-P4DW	4	4	4.5	4	4.5	—	—	—
D-A9□/A9□V	7	—	9	9	9	12	12.5	11.5
D-Z7□/Z80	8	7	9	9.5	10.5	14	14.5	13
D-A3□/A44	9	10	11	11	11	10	10	10
D-A3□/A44C						—	—	—
D-A5□/A6□						10	10	10
D-B5□/B64						—	—	—
D-A59W	13	13	14	14	15	17	17	17
D-B59W	14	14	17	16	18	—	—	—

Note 1) D-A9□/A9□V cannot be mounted on ø50.

Note 2) The following auto switches cannot be mounted on ø125 to ø160.

D-G39C, K39C, A3□C, A44C, G5□, K59, G5□W, K59W, G5BA, G59F, G5NT, B5□, B64, B59W, P4DW.

\* Since the operating range is provided as a guideline including hysteresis, it cannot be guaranteed (assuming approximately ±30% dispersion). It may vary substantially depending on an ambient environment.

## Auto Switch Mounting Bracket: Part No.

### <Tie-rod Mounting>

Auto switch	Bore size (mm)							
	ø40	ø50	ø63	ø80	ø100	ø125	ø140	ø160
D-M9□/M9□V D-M9□W/M9□WV D-M9□A/M9□AV D-A9□/A9□V	BA7-040	BA7-040 (1)	BA7-063	BA7-080	BA7-080	BS5-125	BS5-125	BS5-160
D-F5□/J5□ D-F5□W/J59W D-F5BA/F59F/F5NT D-A5□/A6/A59W	BT-04	BT-04	BT-06	BT-08	BT-08	BT-12	BT-12	BT-16
D-G39C/K39C D-A3□/A44C (2), (3)	BA3-040	BA3-050	BA3-063	BA3-080	BA3-100	—	—	—
D-Y59□/Y7P/Y7□W D-Y69□/Y7PV/Y7□WV D-Y7BA D-Z7□/Z80	BA4-040	BA4-040	BA4-063	BA4-080	BA4-080	BS4-125	BS4-125	BS4-160
D-P4DW (2)	BAP2-040	BAP2-040	BAP2-063	BAP2-080	BAP2-080	—	—	—

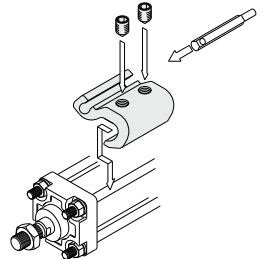

• The above figures show the mounting example of D-A9□(V)/M9□(V)/M9□W(V)/M9□A(V).

### <Band Mounting>

Auto switch	Bore size (mm)							
	ø40	ø50	ø63	ø80	ø100	ø125	ø140	ø160
D-G39/K39 D-A3□/A44	BD1-04M	BD1-05M	BD1-06M	BD1-08M	BD1-10M	BS1-125	BS1-140	BS1-160
D-G5□/K59 D-G5□W/K59W D-G5BA/G59F/G5NT D-B5□/B64/B59W (2)	BA-04	BA-05	BA-06	BA-08	BA-10	—	—	—

Note 1) D-A9□/A9□V cannot be mounted on ø50.

Note 2) The following auto switches cannot be mounted on ø125 to ø160.

D-G39C, K39C, A3□C, A44C, G5□, K59, G5□W, K59W, G5BA, G59F, G5NT, B5□, B64, B59W, P4DW.

Note 3) Auto switch mounting brackets are attached to D-G39C/K39C/A3□C/A44C. When ordering, specify the part number as follows depending on the cylinder size.

(Example) ø40: D-A3□C-4, ø50: D-A3□C-5  
ø63: D-A3□C-6, ø80: D-A3□C-8  
ø100: D-A3□C-10

If auto switch mounting brackets are necessary, order them with the part numbers above.

Note 4) Cylinder tube thickness varies depending on the cylinder type. Take precautions when cylinder types change when band mounting type auto switches are used.

### [Mounting screw set made of stainless steel]

The following set of mounting screws made of stainless steel is available. Use it in accordance with the operating environment.

(Please order the auto switch mounting bracket separately, since it is not included.)

BBA1: For D-F5/J5/A5/A6 types

BBA3: For D-G5/K5/B5/B6 types

Note 5) Refer to pages 1439 and 1447 for the details of BBA1 and BBA3.

Note 6) D-F5BA/G5BA auto switches are set on the cylinder with the stainless steel screws above when shipped. When an auto switch is shipped independently, BBA1 or BBA3 is attached.

Note 6) When using D-M9□(V)/Y7BA, do not use the steel set screws which is included with the auto switch mounting brackets above (BA7-□□□, BA4-□□□, BS5-□□□, BS4-□□□). Order a stainless steel screw set (BBA1) separately, and select and use the M4 x 6L stainless steel set screws included in the BBA1.

## Auto Switch Mounting 4

Besides the models listed in How to Order, the following auto switches are applicable. Refer to pages 1341 to 1435 for the detailed specifications.

Auto switch type	Part no.	Electrical entry (Feiching direction)	Features	Applicable bore size
Solid state	D-M9NV, M9PV, M9BV	Grommet (Perpendicular)	—	ø40 to ø160
	D-Y69A, Y69B, Y7PV		Diagnostic indication (2-color indicator)	
	D-M9NWV, M9PWV, M9BWW		Water resistant (2-color indicator)	
	D-Y7NWV, Y7PWV, Y7BWW		—	
	D-M9NAV, M9PAV, M9BAV	Grommet (In-line)	—	ø40 to ø100
	D-Y59A, Y59B, Y7P		Diagnostic indication (2-color indicator)	
	D-F59, F5P, J59		Water resistant (2-color indicator)	
	D-Y7NW, Y7PW, Y7BW		With timer	
	D-F59W, F5PW, J59W		—	ø40 to ø100
	D-F5BA, Y7BA		Magnetic field resistant (2-color indicator)	
	D-F5NT		—	
	D-G5NT		—	
	D-P5DW	—	—	ø40 to ø160
	Reed	D-A93V, A96V	Grommet (Perpendicular)	
D-A90V		Grommet (In-line)	—	
D-A67, Z80			—	
D-A53, A56, Z73, Z76			—	
D-B53			—	

\* For solid state auto switches, auto switches with a pre-wired connector are also available. Refer to pages 1410 and 1411 for details.

\* Normally closed (NC = b contact) solid state auto switches (D-M9□E(V)/Y7G/Y7H) are also available. Refer to pages 1360 and 1362 for details.



## 1 Both-direction Lock-up Cylinder

Symbol  
**-X51**

CL1 **Mounting type** **Bore size** — **Stroke** — **Suffix** — X51

A type of CA1 series ( $\phi 40$  to  $\phi 100$ ) and CS1 series ( $\phi 125$  to  $\phi 160$ ) air cylinder, this is a bi-directional locked-up cylinder in which two uni-directional locked-up units have been assembled by facing them away from each other.

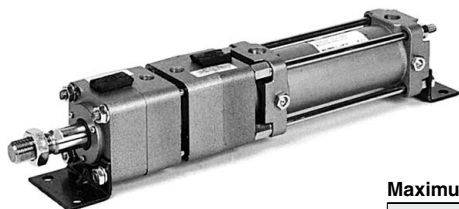

### Cylinder Specifications

Maximum operating pressure	$\phi 40$ to $\phi 100$	1.0 MPa
	$\phi 125$ to $\phi 160$	0.97 MPa
Minimum operating pressure	0.08 MPa	
Action	Double acting	
Piston speed *	50 to 200 mm/s	
Cushion	Equipped	

\* A maximum speed of 500 mm/s is possible if the piston is locked in the stationary state for the purpose of drop prevention.  
Make sure that the piston speed does not exceed 200 mm/s during locking.

### Locked-up Unit Specifications

Locked-up releasing pressure	0.2 MPa or more (at no-load)
Locked-up starting pressure	0.05 MPa or less
Locked-up direction	Both directions
Maximum speed at locked-up	200 mm/s

### Maximum Load and Holding Force of Locking (Max. static load)

Bore size (mm)		40	50	63	80	100	125	140	160
Max. load according to mounting orientation (N)	Horizontal mounting	588	981	1470	2450	3820	6010	7540	9850
	Vertical mounting	294	490	735	1230	1910	3000	3770	4920
Holding force (N)		1230	1920	3060	4930	7700	12100	15100	19700

\* The cylinder can be used to 1/2 of its holding force or below if only a stationary load is applied, such as for drop prevention.

## Construction/Dimensions

$\phi 40$  to  $\phi 100$

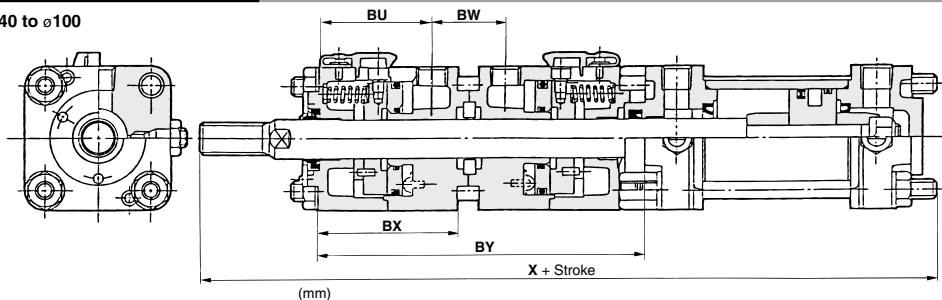

Bore size (mm)	BU	BW	BX	BY	X
40	48	31	59	137	283
50	56	30	67	153	312
63	62	30	73	165	335
80	66	34	77	181	385
100	74	34	85	197	412

\* For dimensions according to mounting type, refer to CL1 series.

$\phi 125$  to  $\phi 160$

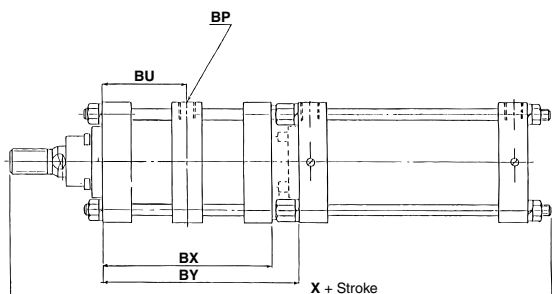

Bore size (mm)	BU	BP	BX	BY	X
125	95.5	3/8	191	220	455
140	104.5	3/8	209	238	473
160	112.5	3/8	225	259	515.5

\* For dimensions according to mounting type, refer to CS1 series.  
\* Added the length of BY for full length dimension.

Note) Locked-up port:  $\phi 40$  to  $\phi 100$  — 2 positions,  $\phi 125$  to  $\phi 160$  — 1 position. In the case of lock releasing of  $\phi 40$  to  $\phi 100$ , be sure to supply air to both locked-up ports and to release the lock.

# CL1 Series Related Products

## Large Bore Lock-up Cylinder (ø180 to ø300)

- This is a lock-up cylinder with a self-locking system that can be mounted onto a large bore air cylinder (CS1 series) from ø180 to ø300, and contains a ring that is tilted by a spring force, which is further tilted by the thrust of the cylinder to securely lock the piston rod.

Produced upon receipt of order.  
Please contact SMC for details.

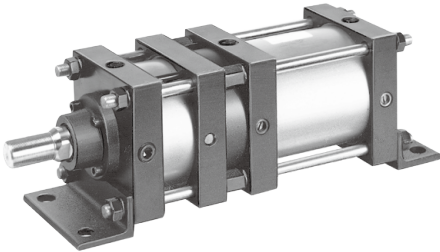

## Specifications

Applicable bore size	ø180, ø200, ø250, ø300
Maximum operating pressure	0.97 MPa
Locked-up releasing pressure	0.2 MPa or more (at no-load)
Locked-up starting pressure	0.05 MPa or less
Locked-up direction	One way (Locking direction is selectable.)
Mounting	Basic type, Foot type, Rod side flange type Head side flange type, Single clevis type Double clevis type, Center trunnion type
Maximum speed at locked-up	200 mm/sec

## Maximum Load and Holding Force of Locking (Max. static load)

Bore size (mm)		180	200	250	300
Max. load according to mounting orientation (N)	Horizontal mounting	12250	14700	24000	29400
	Vertical mounting	6125	7350	12000	14700
Holding force (N)		24500	29400	48000	58800

\* The cylinder can be used to 1/2 of its holding force or below if only a stationary load is applied, such as for drop prevention.



# CL1 Series Specific Product Precautions 1

Be sure to read this before handling the products. Refer to page 9 for safety instructions and pages 10 to 19 for actuator and auto switch precautions.

## Design of Equipment and Machinery

### ⚠ Warning

1. Construct so that the human body will not come into direct contact with driven objects or the moving parts of locking cylinders.  
If there is a risk of contact, provide safety measures such as a cover or a system that uses sensors that will activate an emergency stop before contact is made.
2. Use a balance circuit in which lurching of the piston is taken into consideration. If the lock is applied at a desired position of a stroke and compressed air is applied to only one side of the cylinder, the piston will lurch at a high speed the moment the lock is disengaged. In such a situation, there is a risk of injury to humans, or equipment damage. To prevent the piston from lurching, use a balance circuit such as the recommended pneumatic circuit (P. 1045). Never use oil on the lock-up cylinder because the lock-up cylinder is a non-lube type. Failure to observe this could cause the lock to malfunction.

## Selection

### ⚠ Warning

Refer to the following criteria for the maximum load in the locked state, and set.

Holding force (maximum static load) means the maximum capability of holding a static load that is not accompanied by vibration or impact under the condition that no load is applied. Therefore, it does not refer to a load that cannot be held constantly. To ensure braking force, the maximum load must be set as described below.

1. For constant static loads, such as for drop prevention:  
50% or less of the holding force (maximum static load)
2. When kinetic energy acts upon the cylinder in a locked state, such as when effecting an intermediate stop, there are constraints in terms of the allowable kinetic energy. Therefore, refer to the allowable kinetic energy of the respective series. Furthermore, during locking, the mechanism must sustain the thrust of the cylinder itself, in addition to absorbing the kinetic energy. Therefore, even within a given allowable kinetic energy level, there is an upper limit to the amount of the load that can be sustained.  
Maximum load at horizontal mounting:  
50% or less of the holding force (Maximum static load)  
Maximum load at vertical mounting: 25% or less of the holding force (Maximum static load)

3. In a locked state, do not apply impacts, strong vibrations or rotational forces.  
Do not apply impacts, strong vibrations or rotational forces from external sources, because this could damage or shorten the life of the lock unit.

4. The locking of the lock-up cylinder is unidirectional.  
Because the locking direction is unidirectional, select the locking direction in accordance with the particular operating conditions. Due to the nature of its construction, a lock-up cylinder has a play of approximately 0.5 mm to 1 mm in the axial direction. Therefore, if an external stopper is used to stop the piston rod and the lock is engaged, the piston rod will shift in the amount of its axial play.

5. To effect an intermediate stop, take the cylinder's stopping precision and overrun amount into consideration.

Because the lock is applied by mechanical means, the piston will not stop immediately in response to a stopping signal, but only after a time lag. This lag determines the amount of the overrun of the piston stroke. Thus, the range of the maximum and minimum amounts of the overrun is the stopping precision.

- Place the limit switch before the desired stopping position, only in the amount of the overrun.
- The limit switch must have a detection length (dog length) of the overrun amount +  $\alpha$ .

- For SMC's auto switches, the operating range are between 8 and 14 mm. (It varies depending on a switch model.) When the overrun amount exceeds this range, self-holding of the contact should be performed at the switch load side.

\* For stopping accuracy, refer to page 1021.

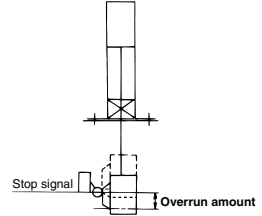

6. In order to further improve stopping accuracy, the time from the stop signal to the operation of the lock should be shortened as much as possible.  
To accomplish this, use a device such as a highly responsive electric control circuit or solenoid valve driven by direct current, and place the solenoid valve as close as possible to the cylinder.
7. Be aware that the stopping accuracy is influenced by changes in the piston speed. The variance in the stopping position increases if the piston speed changes, such as due to load fluctuations during the reciprocal movement of the piston. Therefore, take measures to ensure a constant piston speed immediately preceding the stopping position. Furthermore, the variances in the stopping position increases when the piston is effecting a cushioning stroke or during acceleration after starting its movement.
8. When unlocking is performed, if the thrust is applied to the piston, unlocking will not be easily done. To avoid that, ensure that unlocking should be performed before the thrust is applied to the piston.



# CL1 Series Specific Product Precautions 2

Be sure to read this before handling the products. Refer to page 9 for safety instructions and pages 10 to 19 for actuator and auto switch precautions.

## Mounting

### ⚠ Warning

1. Be certain to connect the rod end to the load with the lock released.
  - If this is performed with the lock engaged, a load that exceeds the allowable rotational force or holding force would be applied to the piston rod, which could damage the locking mechanism. The fine lock and CL1 series with  $\phi 40$  to  $\phi 100$  cylinders have a built-in manual unlocking mechanism. Therefore, they can be maintained in the unlocked state without supplying air. However, it is recommended that the piping is connected to the unlocking port, an air pressure of 0.3 MPa or more is supplied, and the work is performed in the unlocked state. For CL1 series with  $\phi 125$  to  $\phi 160$  cylinders, simply connect piping to the lock-up port, and supply air pressure of 0.2 MPa or more to disengage the lock in order to attach a load.

### ⚠ Caution

1. Do not apply offset loads on the piston rod.
  - Pay particular attention to aligning the center of gravity of the load with the axial center of the cylinder. If there is a large amount of deviation, the piston rod could become unevenly worn or damaged due to the inertial moment that is created when the piston rod is stopped by the lock.

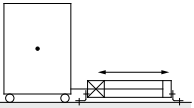

X Load center of gravity and cylinder shaft center are not matched.

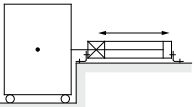

O Load center of gravity and cylinder shaft center are matched.

Note) Can be used if all of the generated moment is absorbed by an effective guide.

2. Do not turn the piston rod with the rod boot kept locked.  
When turning the piston rod, loosen the band once and do not twist the rod boot.
3. Set the breathing hole in the rod boot downward or in the direction that prevents entry of dust or water content.

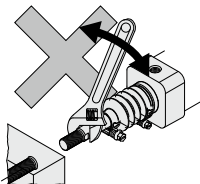

## Adjustment

### ⚠ Caution

1. Place it in the locked position. (Excluding  $\phi 125$  to  $\phi 160$ .)
  - The locks are manually disengaged at the time the cylinders are shipped from the factory. Therefore, make sure to change them to the locked state before using the cylinders. For procedures to effect the change, refer to page 1046 for the fine lock series. Be aware that the lock will not operate properly if the change is not performed correctly.
  - Adjust the cylinder's air balance. In the state in which a load is attached to the cylinder, disengage the lock and adjust the air pressure at the rod side and the head side of the cylinder to obtain a load balance. By maintaining a proper air balance, the piston rod can be prevented from lurching when the lock is disengaged.
2. Adjust the mounting position of detections such as those of the auto switches. To effect an intermediate stop, adjust the mounting position of the auto switch detection by taking the amount of overrun into consideration in relation to the desired stopping position.





# CL1 Series

## Specific Product Precautions 3

Be sure to read this before handling the products. Refer to page 9 for safety instructions and pages 10 to 19 for actuator and auto switch precautions.

### Pneumatic Circuit

#### Warning

1. Be certain to use an pneumatic circuit which will apply balancing pressure to both sides of the piston when in a locked stop.

In order to prevent cylinder lurching after a lock stop, when restarting or when manually unlocking, a circuit should be used to which will apply balancing pressure to both sides of the piston, thereby canceling the force generated by the load in the direction of piston movement.

2. The effective area of the lock release solenoid valve should be at least 50% of the effective area of the cylinder driving solenoid valve, and it should be installed as close to the cylinder as possible so that it is closer than the cylinder driving solenoid valve.

If the effective area of the lock release solenoid valve is smaller than the cylinder driving solenoid valve or if it is installed at a distance from the cylinder, the time required for exhausting air for releasing the lock will be longer, which may cause a delay in the locking operation.

The delay in the locking operation may result in problems such as increase of overruning when performing intermediate stop or emergency stop during operation, or if maintaining position from the operation stop state such as drop prevention, workpieces may be dropped depending on the timing of the load action to the operation delay of the lock.

3. Avoid backflow of the exhaust pressure when there is a possibility of interference of exhaust air, for example for a common exhaust type valve manifold.

The lock may not operate properly when the exhaust air pressure backflows due to interference of the exhaust air when exhausting air for lock release. It is recommended to use an individual exhaust type manifold or individual valves.

4. Allow at least 0.5 seconds from a locked stop (intermediate stop of the cylinder) until release of the lock.

When the locked stop time is too short, the piston rod (and load) may lurch at a speed greater than the control speed of the speed controller.

5. When restarting, control the switching signal for the unlocking solenoid valve so that it acts before or at the same time as the cylinder drive solenoid valve.

If the signal is delayed, the piston rod (and load) may lurch at a speed greater than the control speed of the speed controller.

6. Carefully check for dew condensation due to repeated air supply and exhaust of the locking solenoid valve.

The operating stroke of the lock part is very small. So, if the piping is long and the air supply and exhaust are repeated, the dew condensation caused by the adiabatic expansion accumulates in the lock part. This may corrode internal parts, causing air leak or lock release fault.

#### 7. Basic circuit

1. [Horizontal]

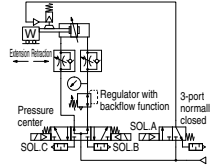

SOLA	SOLB	SOLC	Action	
ON	ON	OFF	Extension	
OFF	OFF	OFF	Locked stop	0.5 s or more
ON	OFF	OFF	Unlocked	0 to 0.5 s
ON	ON	OFF	Extension	
ON	OFF	ON	Retraction	
OFF	OFF	OFF	Locked stop	0.5 s or more
ON	OFF	OFF	Unlocked	0 to 0.5 s
ON	OFF	ON	Retraction	

2. [Vertical]

[Load in the direction of rod extension]

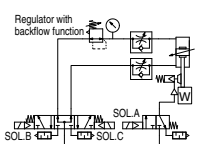

[Load in the direction of rod retraction]

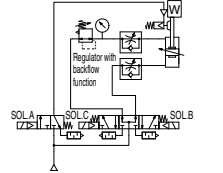

\* The symbol for the lock-up cylinder in the basic circuit uses SMC original symbol (Fine lock cylinder).

#### Caution

1. 3-position pressure center solenoid valve and regulator with backflow function can be replaced with two 3-port normally open valves and a regulator with relief function.

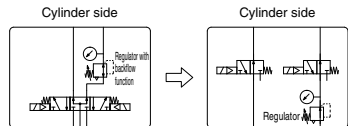

[Example]

1. [Horizontal]

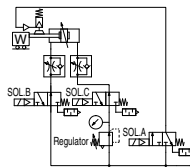

2. [Vertical]

[Load in the direction of rod extension]

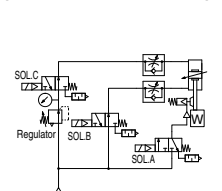

[Load in the direction of rod retraction]

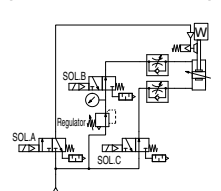

\* The symbol for the lock-up cylinder in the pneumatic circuit uses SMC original symbol (Fine lock cylinder).