

# For High Precision Positioning **Pin Shift Cylinder** **CKQG-X2370/CKQP-X2371**

**ø32, ø40, ø50**

**CKQG-X2370** ø32, ø40, ø50  
(Built-in standard magnet)

**CKQP-X2371** ø50  
(Built-in strong magnet)

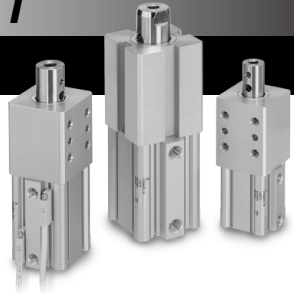

## High Precision

Rod end  
Deflection  $\pm 0.1$  mm or less

- Rod end deflection of  $\pm 0.1$  mm or less is achieved when a load is applied to the rod at its extension end.



## Position Reproducibility

Mounting surface  $\leftrightarrow$  Rod center

Distance accuracy  $\pm 0.1$  mm

\* For details, refer to "Caution on Design" on page 591.

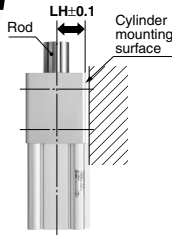

Cylinder mounting surface  
knock pin hole  $\leftrightarrow$  Rod end

Distance accuracy  $\pm 0.1$  mm

Knock pin hole  
(Cylinder mounting surface)

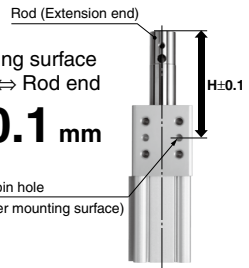

Pin for positioning the workpiece provided by the customer can be directly mounted.

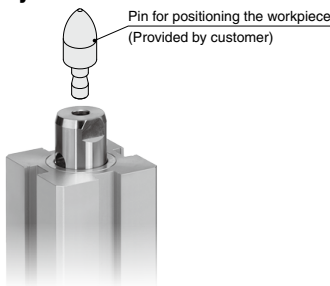

Reduces labor time by integrating the cylinder and guide.

- Reduction in design labor
- Reduction in assembly labor

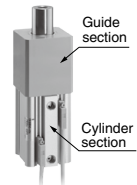

Magnetic field resistant auto switches are mountable.

<Applicable Auto Switches>

CKQG-X2370

- Magnetic field resistant solid state auto switch: D-P3DWA□, D-P4DW□

- Small auto switch: D-M9□, D-A9□

CKQP-X2371

- Magnetic field resistant reed auto switch: D-P7□

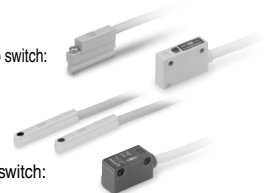

## Built-in coil scraper

- Removes welding spatters, foreign matter, cutting chips, etc. sticking to the piston rod.



The D-P3DWA□ is mountable on 4 surfaces.

\* The D-P4DW□ and D-P7□ are mountable on 3 surfaces.

# Pin Shift Cylinder

## CKQG-X2370

## CKQP-X2371

∅32, ∅40, ∅50

### How to Order

Built-in standard magnet type	CKQG	D	32	-	25	-	P3D	WAL	-	X2370
Built-in standard magnet type	CKQG	D	40	-	25	-	P3D	WAL	-	X2370
Built-in standard magnet type	CKQG	D	50	-	30	-	P3D	WAL	-	X2370
Built-in strong magnet type	CKQP	D	50	-	30	-	P74	L	-	X2371

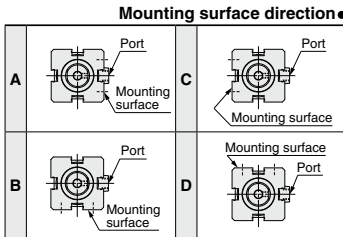

• Mounting surface direction  
• Bore size

• Auto switch  
Select applicable auto switch models from the table below.

Nil	Without auto switch (Built-in magnet)	Number of auto switches
Nil		2 pcs.
S		1 pc.

\* Small auto switches cannot be mounted on the CKQP.

• Cylinder stroke

Bore size (mm)	Stroke (mm)			
	25	30	40	50
32	○	—	○	—
40	—	○	○	—
50	—	○	—	○

• Piston rod end hole size

Bore size	hole size
A	∅10

**Auto Switch Models:** Refer to pages 1341 to 1435 for further information on auto switches.

### Magnetic Field Resistant Auto Switches

Applicable cylinder series	Type	Auto switch model	Applicable magnetic field	Electrical entry	Indicator light	Wiring (Pin no. in use)	Load voltage	Lead wire length	Applicable load
CKQG series	Solid state auto switch	P3D	AC magnetic field (Single-phase AC welding magnetic field)	Pre-wired connector	2-color indicator	2-wire (3-4)	24 VDC	0.3 m	Relay, PLC (Note)
		2-wire (1-4)				0.5 m			
		2-wire				3 m			
		2-wire (1-4)				5 m			
		Pre-wired connector		2-wire (3-4)		0.3 m			
				2-wire (1-4)		5 m			
				2-wire		3 m			
				2-wire		5 m			
CKQP series	Reed auto switch	P79	DC/AC magnetic field	Pre-wired connector	2-color indicator	2-wire (1-4)	24 VDC	0.3 m	Relay, PLC (Note)
		Grommet		1-color indicator	2-wire	24 VDC	3 m		
		Pre-wired connector		2-wire	100 VAC	5 m			
		Grommet		2-wire	100 VAC	5 m			

(Note) PLC: Programmable Logic Controller

**Small Auto Switches** ⚠ Small auto switches cannot be used under a strong magnetic field.

Type	Special function	Electrical entry	Indicator light	Wiring (Output)	Load voltage		Auto switch model		Lead wire length (m)				Pre-wired connector	Applicable load		
					DC	AC	Perpendicular	In-line	0.5 (Nil)	1 (M)	3 (L)	5 (Z)				
Solid state auto switch	—	Grommet	Yes	3-wire (NPN)	24 V	—	M9NV	M9N	●	●	●	○	○	Relay, PLC		
				3-wire (PNP)			M9PV	M9P	●	●	●	○	○			
				2-wire			M9BV	M9B	●	●	●	○	○			
				3-wire (NPN)			M9NWV	M9NW	●	●	●	○	○			
	Diagnostic indication (2-color indicator)			Water resistant (2-color indicator)	3-wire (PNP)	M9PWV	M9PW	●	●	●	○	○	○		○	IC circuit
					2-wire	M9BWV	M9BW	●	●	●	○	○	○			
					3-wire (NPN)	M9NAV	M9NA	○	○	○	●	●	●		IC circuit	
					3-wire (PNP)	M9PAV	M9PA	○	○	○	●	●	●			
Reed auto switch	—	Grommet	No	3-wire (NPN equivalent)	24 V	—	A96V	A96	●	●	●	—	—	IC circuit		
				2-wire			A93V*1	A93	●	●	●	—	—			
				5 V, 12 V			A90V	A90	●	●	●	—	—			
				100 V or less			A90V	A90	●	●	●	—	—			

\* Water resistant type auto switches can be mounted on the above models, but in such case SMC cannot guarantee water resistance.

\* Solid state auto switches marked with "○" are produced upon receipt of order.

\* Auto switches and mounting brackets are shipped together, (but not assembled).

\* 1 m lead wire is only applicable to the D-A93.

\* Lead wire length symbols: 0.5 m.....Nil (Example) M9NWV  
1 m.....M (Example) M9NWVM  
3 m.....L (Example) M9NWVL  
5 m.....Z (Example) M9NWVZ

# Pin Shift Cylinder **CKQG-X2370/CKQP-X2371**

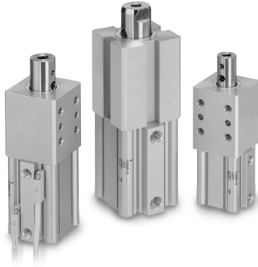

## Specifications

Model	CKQG-X2370			CKQP-X2371
Bore size (mm)	32	40	50	50
Maximum operating pressure	1.0 MPa			
Proof pressure	1.5 MPa			
Minimum operating pressure	0.2 MPa			
Ambient temperature	-10 to 60°C			
Operating air temperature	(No freezing)			
Cushion	None			
Applicable auto switches	D-P3DWA□ D-P4DW□			D-P79WSE D-P74□

## Theoretical Output

Bore size (mm)	Operating direction	Piston area (mm <sup>2</sup> )	Operating pressure (MPa)					
			0.2	0.3	0.4	0.5	0.6	1.0
			(N)					
ø32	OUT	804	160	241	321	402	482	804
	IN	490	98	147	196	245	294	490
ø40	OUT	1256	251	378	502	628	753	1256
	IN	765	153	229	306	382	459	764
ø50	OUT	1964	392	589	785	982	1178	1964
	IN	1256	251	378	502	628	753	1256

## Weight

Model	Bore size (mm)	Stroke (mm)			
		25	30	40	50
(kg)					
CKQG-X2370	32	0.95	—	1.02	—
	40	1.31	—	1.4	—
	50	—	2.1	—	2.3
CKQP-X2371	50	—	2.3	—	2.5

## Rod End Deflection

Bore size (mm)	Stroke (mm)	Lateral load F (N)		
		98	196	294
50	30	±0.1 or less		
	50			
40	25			
	40			
32	25			
	40			

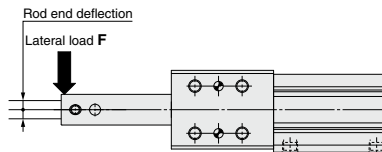

## Caution on Design

### ⚠ Caution

For position reproducibility, a distance accuracy of  $\pm 0.1$  mm from the mounting surface to the rod center (when the piston rod is retracted) is calculated with the root mean square method.

# CKQG-X2370/CKQP-X2371

## Dimensions

### CKQG□32-□-□□-X2370

\* The figures below indicate the CKQGD32-□-□□-X2370.

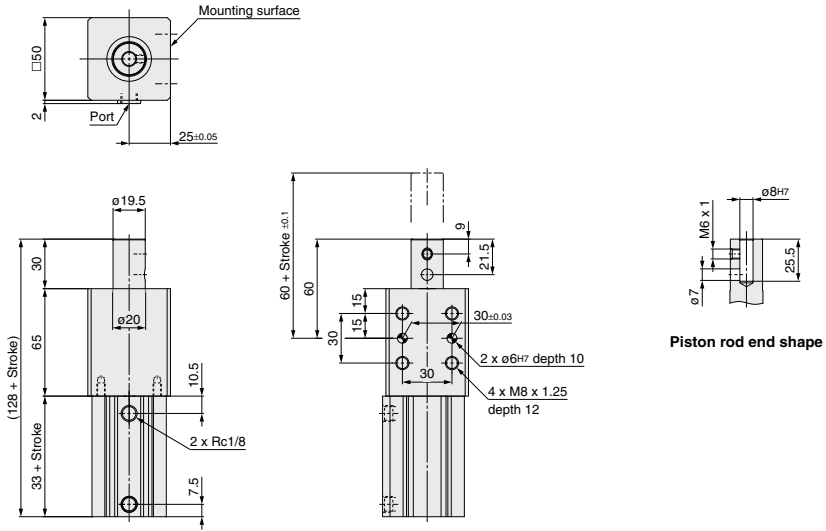

### CKQG□40-□-□□-X2370

\* The figures below indicate the CKQGD40-□-□□-X2370.

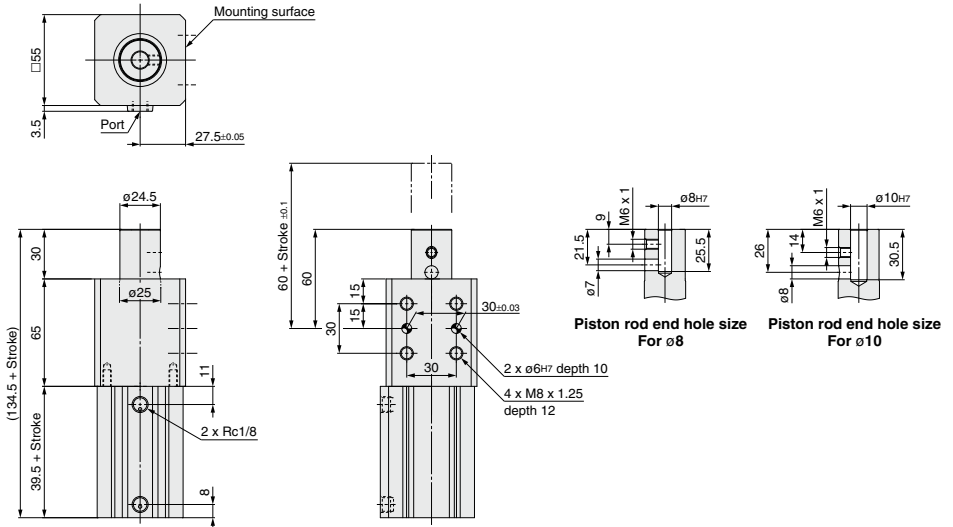

# Pin Shift Cylinder **CKQG-X2370/CKQP-X2371**

## Dimensions

### CKQG□50-□-□□-X2370

\* The figures below indicate the CKQGD50-□-□□-X2370.

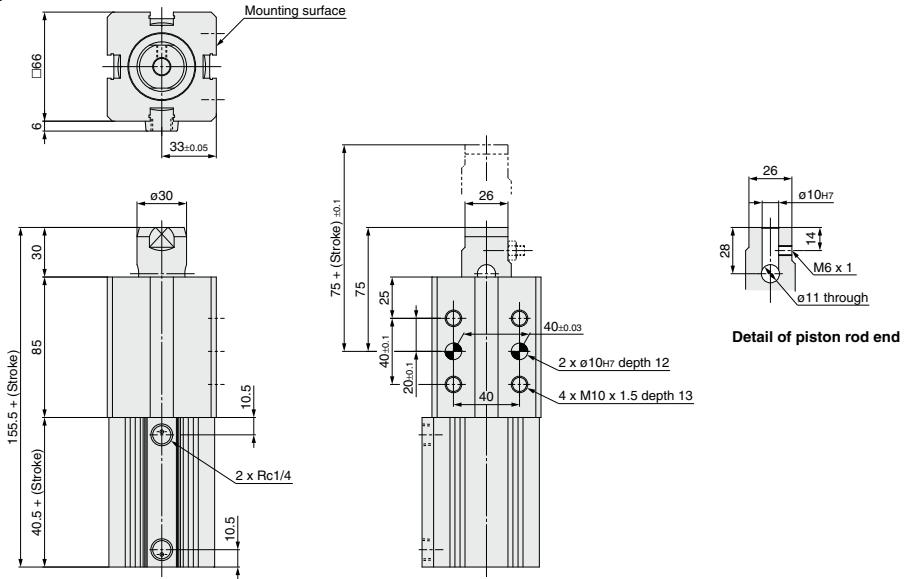

### CKQP□50-□-□□-X2371

\* The figures below indicate the CKQPD50-□-□□-X2371.

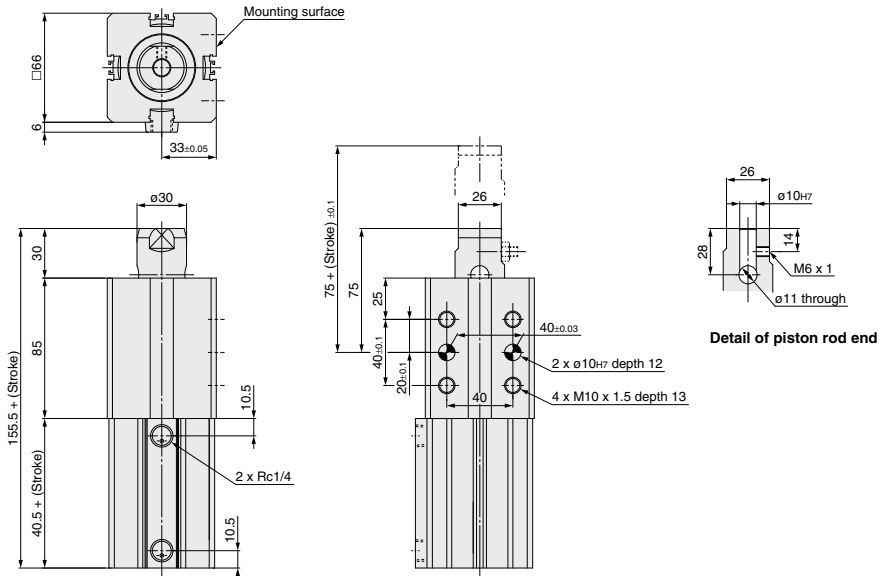

# CKQG-X2370/CKQP-X2371 Auto Switch Mounting

## Auto Switch Proper Mounting Position (Detection at Stroke End) and Its Mounting Height

[CKQG-X2370]

D-P3DWA□

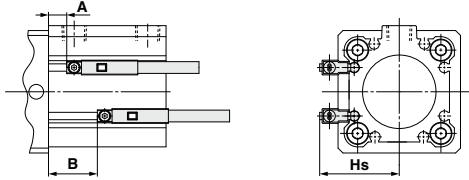

D-P4DW□

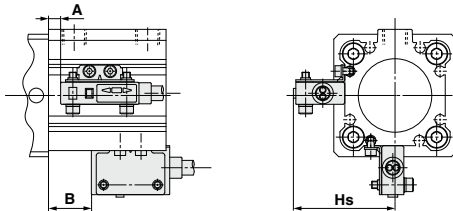

D-M9□(V)  
D-M9□W(V)  
D-M9□A(V)  
D-A9□(V)

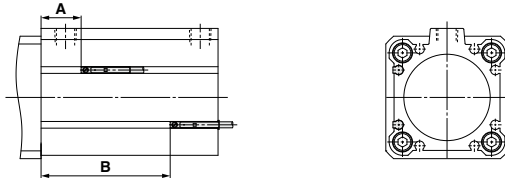

Auto Switch Proper Mounting Position

(mm)

Auto switch model Bore size	D-P3DWA□			D-P4DW□			D-M9□(V) D-M9□W(V) D-M9□A(V)			D-A9□(V)		
	A	B	Hs	A	B	Hs	A	B	Hs	A	B	Hs
32	8.5	8.5 + Stroke	34	6	6 + Stroke	41.3	13	13 + Stroke	—	9	9 + Stroke	—
40	13	13 + Stroke	37.2	10.5	10.5 + Stroke	44.6	18	18 + Stroke	—	14	14 + Stroke	—
50	10.5	10.5 + Stroke	42	9	9 + Stroke	50.3	16	16 + Stroke	—	12	12 + Stroke	—

[CKQP-X2371]

D-P7□

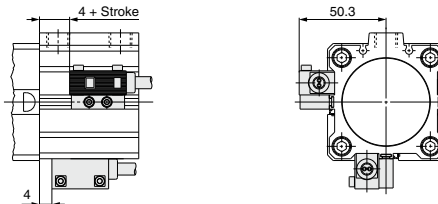

### Mounting

When installing the cylinders with auto switches, pay attention to the bending radius of the auto switch lead wire.  
For details, refer to pages 1341 to 1435 and the Operation Manual.

## Auto Switch Mounting Bracket Part No./Mounting Method

Applicable cylinder	<b>CKQG-X2370</b>		
Applicable auto switch	<b>D-P3DWA□</b>	<b>D-M9□, D-A93□</b>	<b>D-A9□ (Except D-A93)</b>
Bore size (mm)	<b>φ32, φ40, φ50</b>		
Auto switch mounting bracket part no.	No mounting bracket required as the auto switch is directly mounted.		
Auto switch tightening torque	0.2 to 0.3 N·m	0.05 to 0.15 N·m (0.05 to 0.10 N·m for the D-M9□A(V))	0.1 to 0.2 N·m

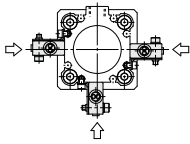
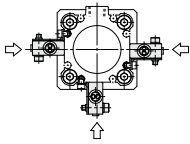
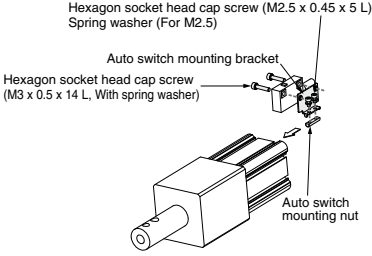
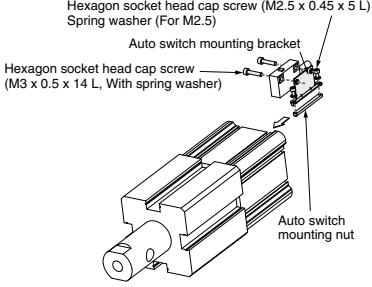
Applicable cylinder	<b>CKQG-X2370</b>		
Applicable auto switch	<b>D-P4DW□</b>		
Bore size (mm)	<b>φ32, φ40</b>	<b>φ50</b>	
Auto switch mounting bracket part no.	<b>BQ7-032</b>	<b>BQ7-050</b>	
Auto switch mounting bracket fitting parts lineup/weight	<ul style="list-style-type: none"> <li>● Auto switch mounting bracket</li> <li>● Auto switch mounting nut</li> <li>● Hexagon socket head cap screw (M3 x 0.5 x 14 L, With spring washer)</li> </ul>	<ul style="list-style-type: none"> <li>● Hexagon socket head cap screw (M2.5 x 0.45 x 5 L)</li> <li>● Spring washer (For M2.5)</li> <li>Weight = 8.5 g</li> </ul>	<ul style="list-style-type: none"> <li>● Auto switch mounting bracket</li> <li>● Auto switch mounting nut</li> <li>● Hexagon socket head cap screw (M3 x 0.5 x 14 L, With spring washer)</li> </ul>
Auto switch mounting surface	Surfaces with auto switch mounting slot		Surfaces with auto switch mounting slot
			
Mounting of auto switch	<ol style="list-style-type: none"> <li>1. Fix the auto switch and the auto switch mounting bracket temporarily with the hexagon socket head cap screws (M3 x 14 L).</li> <li>2. Insert the hexagon socket head cap screws (M2.5 x 5 L) into the spring washers (for M2.5), and tighten the auto switch mounting bracket and auto switch mounting nut temporarily.</li> <li>3. Insert the temporarily fixed auto switch mounting nut into the mating groove of the cylinder tube.</li> <li>4. Check the detecting position of the auto switch and fix the auto switch firmly with the hexagon socket head cap screws (M2.5 x 5 L, M3 x 14 L).</li> </ol> <p>Note 1) The tightening torque for the hexagon socket head cap screw (M3 x 14 L) is 0.5 to 0.6 N·m.</p> <p>Note 2) The tightening torque for the hexagon socket head cap screw (M2.5 x 5 L) is 0.25 to 0.35 N·m.</p> <div style="text-align: center; margin-top: 10px;">  </div>	<ol style="list-style-type: none"> <li>1. Fix the auto switch and the auto switch mounting bracket temporarily with the hexagon socket head cap screws (M3 x 14 L).</li> <li>2. Insert the hexagon socket head cap screws (M2.5 x 5 L) into the spring washers (for M2.5), and tighten the auto switch mounting bracket and auto switch mounting nut temporarily.</li> <li>3. Insert the temporarily fixed auto switch mounting nut into the mating groove of the cylinder tube.</li> <li>4. Check the detecting position of the auto switch and fix the auto switch firmly with the hexagon socket head cap screws (M2.5 x 5 L, M3 x 14 L).</li> </ol> <p>Note 1) The tightening torque for the hexagon socket head cap screw (M3 x 14 L) is 0.5 to 0.6 N·m.</p> <p>Note 2) The tightening torque for the hexagon socket head cap screw (M2.5 x 5 L) is 0.25 to 0.35 N·m.</p> <div style="text-align: center; margin-top: 10px;">  </div>	

# CKQG-X2370/CKQP-X2371

## Auto Switch Mounting Bracket Part No./Mounting Method

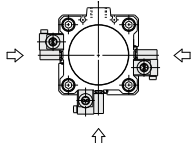
Applicable cylinder	CKQP-X2371
Applicable auto switch	D-P7□
Bore size (mm)	ø50
Auto switch mounting bracket part no.	BQP1T-050
Auto switch mounting bracket fitting parts lineup/weight	<ul style="list-style-type: none"> <li>● Auto switch mounting bracket</li> <li>● Auto switch mounting nut</li> <li>● Hexagon socket head cap screw (M3 x 0.5 x 14 L)</li> <li>● Spring washer (For M2.5) Weight = 16 g</li> <li>● Hexagon socket head cap screw (M3 x 0.5 x 14 L, With spring washer) Weight = 16 g</li> </ul>
Auto switch mounting surface	<p>Surfaces with auto switch mounting slot</p> 
Mounting of auto switch	<ol style="list-style-type: none"> <li>1. Mount the auto switch mounting bracket onto the auto switch mounting nut by tightening the bracket mounting screws lightly the through hole on the top of bracket.</li> <li>2. Insert the nut section of the auto switch mounting bracket assembly (bracket + nut) into the groove of the rail and set it at the auto switch mounting position.</li> <li>3. Insert the auto switch mounting screws into the through hole of the auto switch, and fix the auto switch mounting bracket and auto switch temporarily.</li> <li>4. Check the detecting position of the auto switch and fix the auto switch firmly with the auto switch mounting screws and bracket mounting screws. (The tightening torque is 0.5 to 0.7 N·m.)</li> </ol> <p>Note) Be careful of the mounting direction of the D-P79WSE when installed to the auto switch mounting bracket. Be sure the soft-resin mold surface faces the auto switch mounting bracket side when mounting.</p> 