

3-Screen Display

High-Precision Digital Pressure Switch

Air	1.0 MPa	ISE70	1.6 MPa	ISE71
General fluids	1.0 MPa	ISE70G	2.0 MPa	ISE75G
	5.0 MPa	ISE76G	10 MPa	ISE77G
	16 MPa	ISE78G <small>New</small>	50 MPa	ISE79S

IO-Link



* The ISE78G is not in compliance with UL standards.

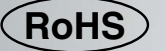

It is possible to change the settings while checking the measured value.

Main screen

Measured value (Current pressure value)

Sub screen

Label (Display item), Set value (Threshold value)

Visualization of Settings

Set value (Threshold value)	P_1
Hysteresis value	H_1
Peak value	H_H_1
Bottom value	H_L_0



Angled display Good visibility from various mounting positions



Rotating display

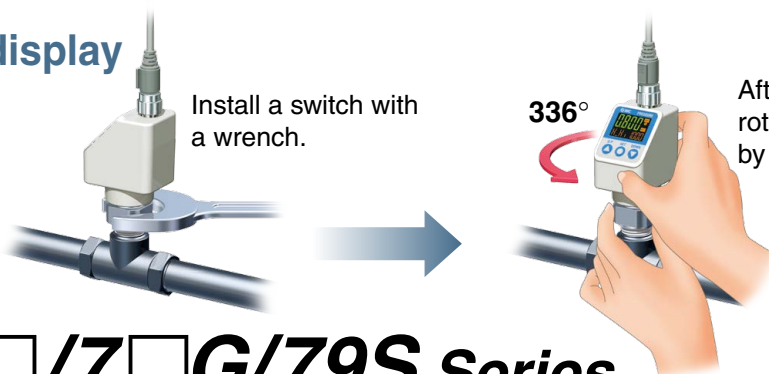

Install a switch with a wrench.

336°

After installation, the display can be rotated to an easy-to-see direction by securing the body by hand.

ISE7□/7□G/79S Series



CAT.ES100-123C [Ⓐ]

Visualization of Settings

The sub screen (label) shows the item to be set.

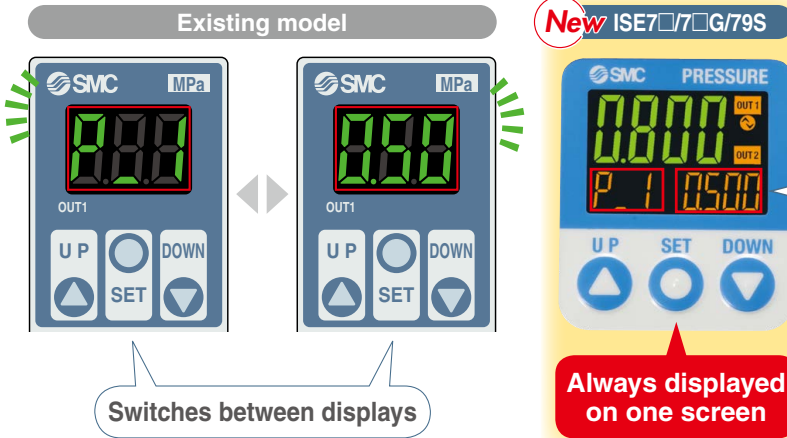

Mode Examples

Hysteresis mode

Normal output (Threshold value) | Reversed output (Threshold value)

P_1 0.500 | n_1 0.500

Hysteresis | Set hysteresis value

H_1 0.050

Window comparator mode

Normal output/ Lo side (Threshold value) | Normal output/ Hi side (Threshold value)

P_L 0.300 | P_H 0.600

Reversed output/ Lo side (Threshold value) | Reversed output/ Hi side (Threshold value)

n_L 0.300 | n_H 0.600



Simple 3-Step Setting

When the SET button is pressed and the set value (P_1) is being displayed, the set value (threshold value) can be set. When the SET button is pressed and the hysteresis value (H_1) is being displayed, the hysteresis value can be set.

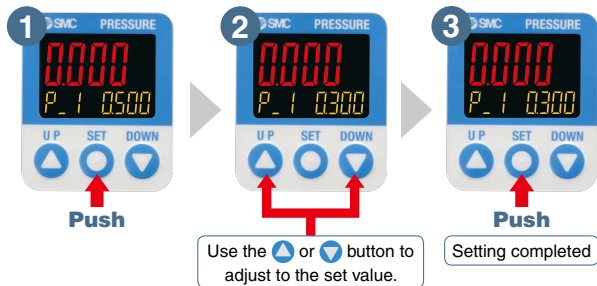

Now with a snap shot function for set value reading

Pressing the UP and DOWN buttons simultaneously for at least 1 s will make the set value (threshold value) the same as the current pressure value.

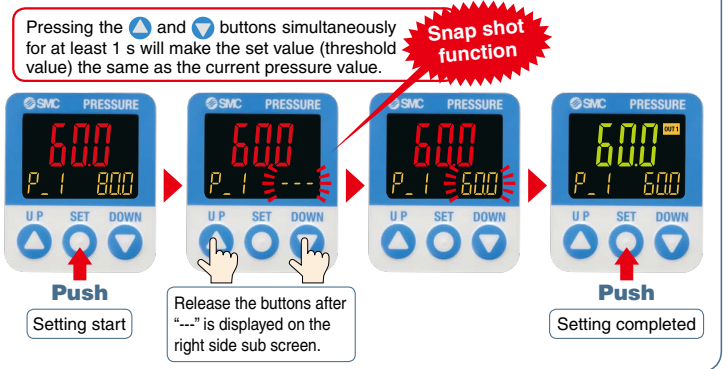

NPN/PNP Switch Function

Both NPN and PNP are available. The number of stock items can be reduced.

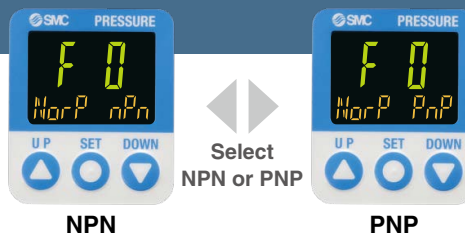

Other Sub Screen Display

The peak value, bottom value, or both values can be displayed on one screen!

* Peak and bottom values are maintained even if the power supply is cut.

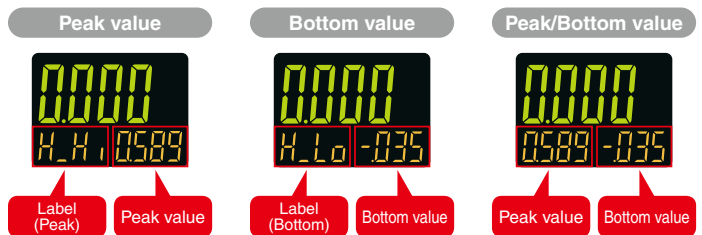

Output mode/Output type display				Rated range display	Level bar display	Pressure unit display			
Hysteresis mode		Window comparator mode		Positive pressure range		kPa	MPa	psi*1	bar*1
Normal output	Reversed output	Normal output	Reversed output	P W	0000 0	KPA	MPA	PSI	BAR

*1 "psi" and "bar" can be selected when the unit selection function is available.
* A combination of the displays shown above and the set values can be displayed on the 2 sub screens.

Convenient Functions

Security code

The key-lock function keeps unauthorized persons from tampering with the settings.

Power saving mode

Power consumption is reduced by turning OFF the monitor. (Reduce power consumption by approx. 60%.)

Resolution switch function

Reduces monitor flickering

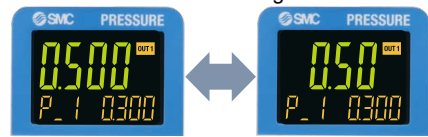

(Only the displayed values are changed; the accuracy remains the same.)

Applied pressure error

When the applied pressure exceeds the rated pressure, the pressure application is counted as an applied pressure error (the max. number of applied pressure errors is 1000 counts).



The number of applied pressure errors



3 Setting Modes

Select the setting mode that best meets your needs.

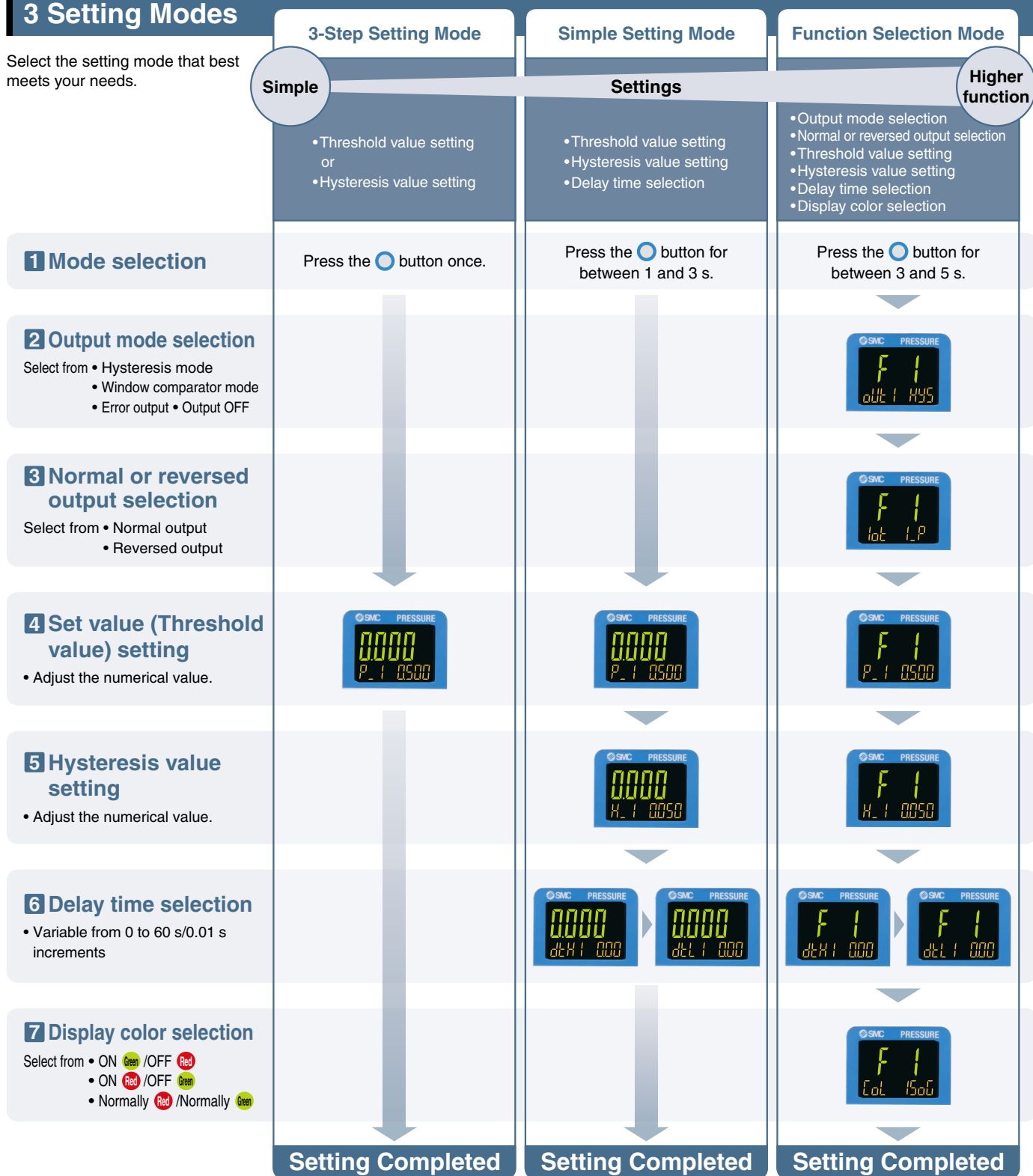

* The chart above shows OUT1 operations. The Function Selection Mode for OUT2 is set using "F2." "2" will be displayed instead of "1" in the illustration above. (Example) P_1 → P_2

IO-Link Compatible

Visualization of operation and equipment status/Remote monitoring and control by communication



IO-Link is an open communication interface technology between the sensor/actuator and the I/O terminal that is an international standard, IEC 61131-9.

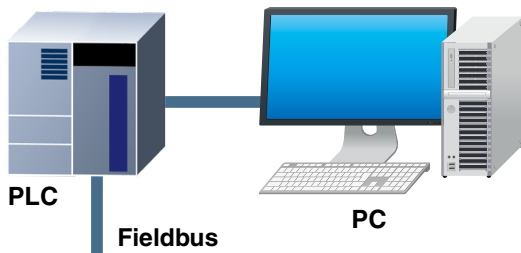

Configuration File (IODD File*1)

•Manufacturer •Product part no. •Set value

*1 IODD File:

IODD is an abbreviation of IO Device Description. This file is necessary for setting the device and connecting it to a master. Save the IODD file on the PC to be used to set the device prior to use.

Device settings can be set by the master.

- Threshold value
- Operation mode, etc.

Readable device data:

- Switch ON/OFF signal and analog value
- Device information: Manufacturer, Product part number, Serial number, etc.
- Normal or abnormal device status
- Cable breakage

Confirm the pressure condition during operation and monitor the device status.

Monitor the abnormal pressure and the abnormal status of a pressure sensor remotely to prevent unexpected stops.

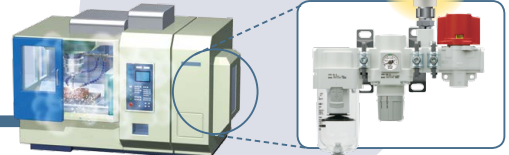

IO-Link Master

IO-Link Compatible Device: Pressure Sensor

Implement diagnostic bits in the process data.

The diagnostic bit in the cyclic process data makes it easy to find problems with the equipment. It is possible to find problems with the equipment in real time using the cyclic (periodic) data and to monitor such problems in detail with the noncyclic (aperiodic) data.

Process Data

Bit offset	Item	Note
0	OUT1 output	0: OFF 1: ON
1	OUT2 output	0: OFF 1: ON
2	Diagnosis	0: Normal 1: Abnormal
3 to 15	Measured pressure value	Unsigned 13 bit

Diagnosis items

- Internal product malfunction
- Outside of zero-clear range
- Outside of rated pressure range
- Upper temperature limit exceeded inside the product

Bit offset	15	14	13	12	11	10	9	8	7	6	5	4	3	2	1	0
Item	Measured pressure value													Diagnosis	OUT2	OUT1

Display function

Displays the output communication status and indicates the presence of communication data







Operation and Display

Communication with master	IO-Link status indicator light	Status	Screen display*3	Description	
Yes	COM*1	IO-Link mode	Operate	Mode oPE	Normal communication status (readout of measured value) At the start of communication
			Start up	Mode Start	
			Preoperate	Mode Pre	
No	OFF	SIO mode	Version does not match	Er 15 V 10	IO-Link version does not match that of the master. The master uses version 1.0.
			Lock	Mode Loc	
No	OFF	SIO mode	Communication disconnection	Mode oPE Mode Start Mode Pre	Normal communication was not received for 1 s or longer.
			General switch output	Mode S IO	

*1 The COM indicator is ON when communication with the master is established. *2 In IO-Link mode, the IO-Link indicator is ON or flashes. *3 When the sub screen is set to Mode

Introduction of Series

	ISE70/71 p. 7		ISE70G/75G/76G/77G/78G/79S pp. 9, 11					
								
Applicable fluid	 Air		 General fluids					
Model	ISE70	ISE71	ISE70G	ISE75G	ISE76G	ISE77G	ISE78G	ISE79S
Rated pressure range	1.0 MPa	1.6 MPa	1.0 MPa	2.0 MPa	5.0 MPa	10 MPa	16 MPa	50 MPa
Withstand pressure	1.5 MPa	2.4 MPa	3.0 MPa	5.0 MPa	12.5 MPa	30 MPa	48 MPa	75 MPa
Power supply voltage	When used as a switch output device 12 to 24 VDC ±10% with 10% voltage ripple or less							
	When used as an IO-Link device 18 to 30 VDC, including ripple (p-p) 10%							
Temperature characteristics	±2% F.S. (25°C standard)		±3% F.S. (ISE70G)/±5% F.S. (ISE75G/76G/77G/78G/79S)					
Repeatability	±0.5% F.S.							
Hysteresis	Hysteresis mode: Variable Window comparator mode: Variable							
Output type	Select from NPN or PNP open collector.							
Number of screens/ Display type	3-screen/2-color display							
Enclosure	IP67							
Materials of parts in contact with fluid	Sensor pressure receiving area: Silicon Piping port: C3604 (Electroless nickel plating) Sensor seal: HNBR		Sensor pressure receiving area: Al ₂ O ₃ (Alumina 96%) Piping port: C3604 (Electroless nickel plating) Sensor seal: FKM + Grease (ISE70G) FKM (ISE75G/76G/77G/78G)				Sensor pressure receiving area, Piping port: Equivalent to stainless steel 630	
Piping	Rc1/4, NPT1/4, G1/4 (ISO 1179-1 compliant)							Rc1/4, G1/4 (ISO 1179-1 compliant)
Option	Lead wire with M12 connector, Bracket							
Note	Selectable pressure unit, Anti-chattering function, Display calibration function, Power saving mode, Sub screen setting function							

Select either the integrated type or the remote type according to the application.

<Integrated type>

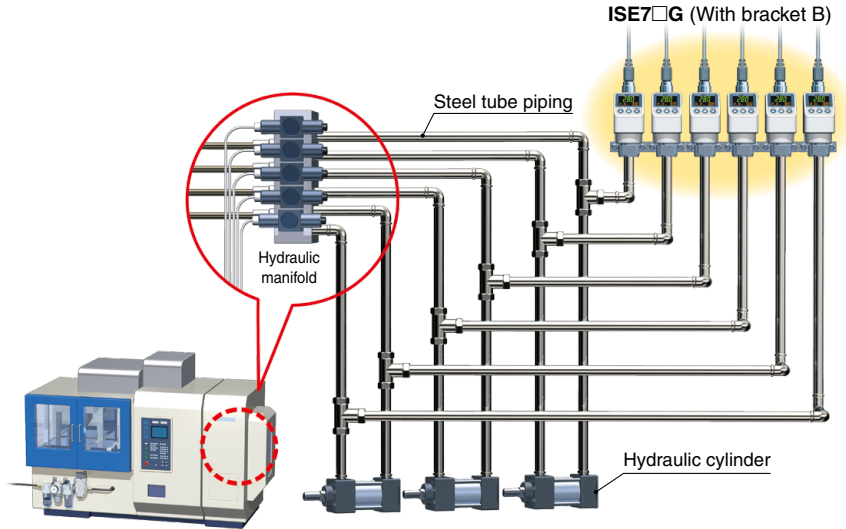

<Remote type>



+



or



■ PSE56□ Series

- Material of parts in contact with fluid: Stainless steel 316L
- Select from a face seal or compression fitting.



For details, refer to the Web Catalog.

■ PSE57□ Series

- Materials of parts in contact with fluid
Piping port: C3604 + Nickel plating
Pressure sensor: Al₂O₃ (Alumina 96%)
Sensor seal: FKM + Grease (PSE570/573/574)
FKM (PSE575/576/577)
- Withstand voltage: 500 VAC



For details, refer to the Web Catalog.

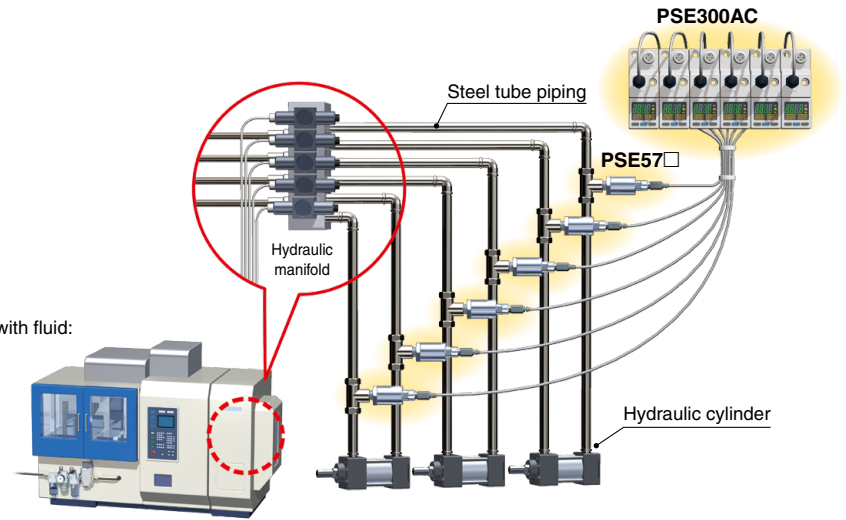

Application Examples

For High pressure For the high-pressure main spindle drill pressure control

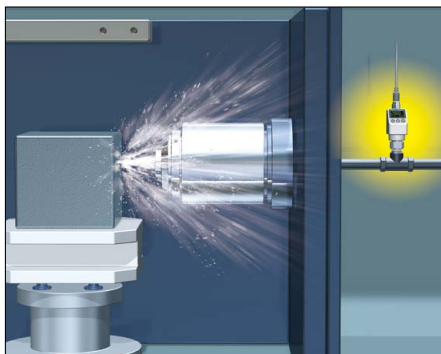

For the liquid coolant pressure control



For the PET bottle molding machine pressure control

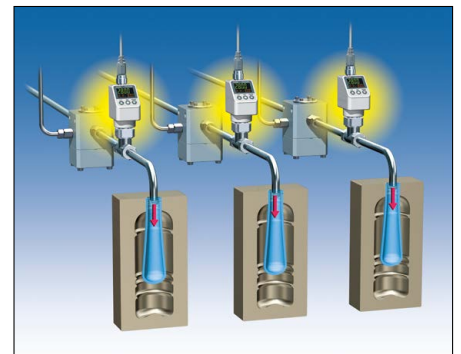

CONTENTS

3-Screen Display High-Precision Digital Pressure Switch *ISE7□/7□G/79S Series*



3-Screen Display High-Precision Digital Pressure Switch: For Air **ISE70/71 Series**

How to Order	p. 7
Options/Part Nos.	p. 7
Specifications	p. 8

3-Screen Display High-Precision Digital Pressure Switch: For General Fluids **ISE70G/75G/76G/77G/78G Series**

How to Order	p. 9
Options/Part Nos.	p. 9
Specifications	p. 10

3-Screen Display High-Precision Digital Pressure Switch: For General Fluids **ISE79S Series**

How to Order	p. 11
Options/Part Nos.	p. 11
Specifications	p. 12

Set Pressure Range and Rated Pressure Range	p. 13
Internal Circuits and Wiring Examples	p. 13
Dimensions	p. 14
Function Details	p. 15
Safety Instructions	Back cover

3-Screen Display



IO-Link



UK
CA



High-Precision Digital Pressure Switch: For Air



ISE70/71 Series



How to Order

ISE70 - 02 - L2 - M

Pressure range

Model	Description
ISE70	0 to 1 MPa
ISE71	0 to 1.6 MPa

Piping specification

Symbol	Description
02	Rc1/4
N02	NPT1/4
F02	G1/4*1

*1 ISO 1179-1 compliant

Output specification*1

Symbol	Description
L2	IO-Link: Switch output 1 + Switch output 2 (Switch output: NPN or PNP switching type)
AB	Switch output 1 + Switch output 2 (NPN or PNP switching type)

*1 Refer to pages 8 and 13 for details.

Unit specification

Symbol	Description
Nil	Units selection function*1
M	SI units only*2

*1 Under the New Measurement Act, switches with the units selection function are no longer allowed for use in Japan.

*2 Fixed units: MPa, kPa

Option 3

Symbol	Description
Nil	Operation manual
Y	None
K	Operation manual + Calibration certificate
T	Calibration certificate

Option 2

Symbol	Description
Nil	None
A	Bracket A (Interchangeable with ISE70)
B	Bracket B

Option 1

Symbol	Description
Nil	None
S	Lead wire with M12 connector (Straight, 5 m)
L	Lead wire with M12 connector (Right-angled, 5 m)

Options/Part Nos.

When only optional parts are required, order with the part numbers listed below.

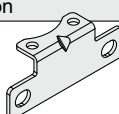
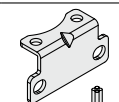
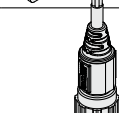
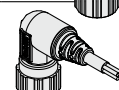
Description	Part no.	Note
Bracket A 	ZS-50-A	Interchangeable with ISE70 With 2 mounting screws (M4 x 6 L)
Bracket B 	ZS-50-B	With 2 mounting screws (M4 x 6 L)
Lead wire with M12 connector: Straight 	ZS-31-B	Lead wire length: 5 m
Lead wire with M12 connector: Right-angled 	ZS-31-C	Lead wire length: 5 m



For pressure switch precautions and specific product precautions, refer to the "Operation Manual" on the SMC website.

Specifications

Model		ISE70	ISE71	
Applicable fluid		Air, Non-corrosive gas, Non-flammable gas		
Pressure	Rated pressure range	0 to 1.000 MPa	0 to 1.600 MPa	
	Display/Set pressure range	-0.105 to 1.050 MPa	-0.105 to 1.680 MPa	
	Display/Smallest settable increment	0.001 MPa	0.001 MPa	
	Withstand pressure	1.5 MPa	2.4 MPa	
Power supply	Power supply voltage	When used as a switch output device	12 to 24 VDC ±10% with 10% voltage ripple or less	
		When used as an IO-Link device	18 to 30 VDC, including ripple (p-p) 10%	
	Current consumption	35 mA or less		
	Protection	Polarity protection		
Accuracy	Display accuracy	±2% F.S. ±1 digit (Ambient temperature of 25 ±3°C)		
	Repeatability	±0.5% F.S.		
	Temperature characteristics	±2% F.S. (25°C standard)		
Switch output (During SIO mode for output specifications "AB" or "L2")	Output type	Select from NPN or PNP open collector output.		
	Output mode	Hysteresis, Window comparator, Error output, Output OFF		
	Switch operation	Normal output, Reversed output		
	Max. load current	80 mA		
	Max. applied voltage	30 V (NPN output)		
	Internal voltage drop (Residual voltage)	1.5 V or less (at load current of 80 mA)		
	Delay time*1	1.5 ms or less, variable from 0 to 60 s/0.01 s increments		
	Hysteresis	Hysteresis mode	Variable from 0*2	
		Window comparator mode		
Short circuit protection	Yes			
Display	Unit*3	MPa, kPa, kgf/cm ² , bar, psi		
	Display type	LCD		
	Number of screens	3-screen display (Main screen, Sub screen x 2)		
	Display color	Main screen: Red/Green, Sub screen: Orange		
	Number of display digits	Main screen: 4 digits (7 segments), Sub screen: 4 digits (Upper 1 digit 11 segments, 7 segments for other)		
	Indicator light	Lights up when switch output is turned ON (OUT1, OUT2: Orange)		
Digital filter*4		Variable from 0 to 30 s/0.01 s increments		
Environmental resistance	Enclosure	IP67		
	Withstand voltage	1000 VAC for 1 min between terminals and housing		
	Insulation resistance	50 MΩ or more (500 VDC measured via megohmmeter) between terminals and housing		
	Fluid temperature range	0 to 50°C (No condensation or freezing)		
	Operating temperature range	Operating: 0 to 50°C, Stored: -10 to 60°C (No condensation or freezing)		
	Operating humidity range	Operating/Stored: 35 to 85% RH (No condensation)		
Standards		UL/CSA (E216656), CE/UKCA marking		
Piping	Port size	Rc1/4, NPT1/4, G1/4		
	Materials of parts in contact with fluid	Sensor pressure receiving area: Silicon Piping port: C3604 (Electroless nickel plating), Sensor seal: HNBR		
Weight	Body	Port size Rc1/4	153 g	
		Port size NPT1/4	152 g	
		Port size G1/4	150 g	
	Lead wire with connector	139 g		
Communication (IO-Link mode)	IO-Link type	Device		
	IO-Link version	V1.1		
	Communication speed	COM2 (38.4 kbps)		
	Configuration file	IODD file*5		
	Min. cycle time	2.3 ms		
	Process data length	Input data: 2 bytes, Output data: 0 byte		
	On request data communication	Yes		
	Data storage function	Yes		
	Event function	Yes		
Vendor ID	131 (0 x 0083)			

*1 Value without digital filter (at 0 ms)

*2 If the applied pressure fluctuates around the set value, the hysteresis must be set to a value more than the amount of fluctuation, or chattering will occur.

*3 Setting is only possible for models with the units selection function. Only MPa or kPa is available for models without this function.

*4 The response time indicates when the set value is 90% in relation to the step input.

*5 The configuration file can be downloaded from the SMC website, <https://www.smcworld.com>

* Products with tiny scratches, marks, or display color or brightness variations which do not affect the performance of the product are verified as conforming products.

3-Screen Display

* The ISE78G is not in compliance with UL standards.

High-Precision Digital Pressure Switch: For General Fluids

RoHS

ISE70G/75G/76G/77G/78G Series

How to Order



ISE70G - **02** - **L2** - **M**

Pressure range

Model	Description
ISE70G	0 to 1 MPa
ISE75G	0 to 2 MPa
ISE76G	0 to 5 MPa
ISE77G	0 to 10 MPa
ISE78G	0 to 16 MPa

Piping specification

Symbol	Description
02	Rc1/4
N02	NPT1/4
F02	G1/4*1

*1 ISO 1179-1 compliant

Orifice

Symbol	Description
Nil	None
T	Yes*1

*1 Orifice is shipped together with the product.

Output specification*1

Symbol	Description
L2	IO-Link: Switch output 1 + Switch output 2 (Switch output: NPN or PNP switching type)

*1 Refer to pages 10 and 13 for details.

Unit specification

Symbol	Description
Nil	Units selection function*1
M	SI units only*2

*1 Under the New Measurement Act, switches with the units selection function are no longer allowed for use in Japan.

*2 Fixed units: MPa, kPa

Option 3

Symbol	Description
Nil	Operation manual
Y	None
K	Operation manual + Calibration certificate
T	Calibration certificate

Option 2



Symbol	Description
Nil	None
A	Bracket A (Interchangeable with ISE75(H))
B	Bracket B

Option 1

Symbol	Description
Nil	None
S	Lead wire with M12 connector (Straight, 5 m)
L	Lead wire with M12 connector (Right-angled, 5 m)

Options/Part Nos.

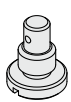
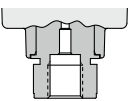
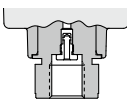
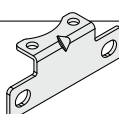
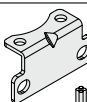
When only optional parts are required, order with the part numbers listed below.

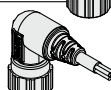
Description	Part no.	Note
Orifice 	ZS-48-A	  Without orifice With orifice
Bracket A 	ZS-50-A	Interchangeable with ISE75(H) With 2 mounting screws (M4 x 6 L)
Bracket B 	ZS-50-B	With 2 mounting screws (M4 x 6 L)
Lead wire with M12 connector: Straight 	ZS-31-B	Lead wire length: 5 m
Lead wire with M12 connector: Right-angled 	ZS-31-C	Lead wire length: 5 m



For pressure switch precautions and specific product precautions, refer to the "Operation Manual" on the SMC website.

Specifications

Model		ISE70G	ISE75G	ISE76G	ISE77G	ISE78G
Applicable fluid		Liquid or gas that will not corrode materials of parts in contact with fluid				
Pressure	Rated pressure range	0 to 1.000 MPa	0 to 2.000 MPa	0 to 5.00 MPa	0 to 10.00 MPa	0 to 16.00 MPa
	Display/Set pressure range	-0.105 to 1.050 MPa	-0.105 to 2.100 MPa	-0.25 to 5.25 MPa	-0.50 to 10.50 MPa	-0.80 to 16.80 MPa
	Display/Smallest settable increment	0.001 MPa	0.001 MPa	0.01 MPa	0.01 MPa	0.01 MPa
	Withstand pressure	3.0 MPa	5.0 MPa	12.5 MPa	30 MPa	48 MPa
Power supply	Power supply voltage	When used as a switch output device	12 to 24 VDC ±10% with 10% voltage ripple or less			
		When used as an IO-Link device	18 to 30 VDC, including ripple (p-p) 10%			
	Current consumption	35 mA or less				
Accuracy	Protection	Polarity protection				
	Display accuracy	±2% F.S. ±1 digit (Ambient temperature of 25 ±3°C)				
	Repeatability	±0.5% F.S.				
Switch output (SIO mode)	Temperature characteristics (25°C standard)	±3% F.S.	±5% F.S.			
	Output type	Select from NPN or PNP open collector output.				
	Output mode	Hysteresis, Window comparator, Error output, Output OFF				
	Switch operation	Normal output, Reversed output				
	Max. load current	80 mA				
	Max. applied voltage	30 V (NPN output)				
	Internal voltage drop (Residual voltage)	1.5 V or less (at load current of 80 mA)				
	Delay time*1	2 ms or less, variable from 0 to 60 s/0.01 s increments				
	Hysteresis	Hysteresis mode	Variable from 0*2			
		Window comparator mode				
Short circuit protection	Yes					
Display	Unit*3	MPa, kPa, kgf/cm ² , bar, psi				
	Display type	LCD				
	Number of screens	3-screen display (Main screen, Sub screen x 2)				
	Display color	Main screen: Red/Green, Sub screen: Orange				
	Number of display digits	Main screen: 4 digits (7 segments), Sub screen: 4 digits (Upper 1 digit 11 segments, 7 segments for other)				
	Indicator light	Lights up when switch output is turned ON (OUT1, OUT2: Orange)				
Digital filter*3,4	Variable from 0 to 30 s/0.01 s increments					
Environmental resistance	Enclosure	IP67				
	Withstand voltage	500 VAC for 1 min between terminals and housing				
	Insulation resistance	50 MΩ or more (500 VDC measured via megohmmeter) between terminals and housing				
	Fluid temperature range	-5 to 70°C (No condensation or freezing)				
	Operating temperature range	Operating: -5 to 50°C, Stored: -10 to 60°C (No condensation or freezing)				
Operating humidity range	Operating/Stored: 35 to 85% RH (No condensation)					
Standards	UL/CSA (E216656), CE/UKCA marking				CE/UKCA marking	
Piping	Port size	Rc1/4, NPT1/4, G1/4				
	Materials of parts in contact with fluid	Sensor pressure receiving area: Al ₂ O ₃ (Alumina 96%), Piping port: C3604 (Electroless nickel plating), Sensor seal: FKM + Grease (1 MPa), FKM (2, 5, 10, 16 MPa)				
Weight	Body	Port size Rc1/4	184 g			
		Port size NPT1/4	183 g			
		Port size G1/4	181 g			
	Option	Lead wire with connector	139 g			
		Bracket A	17.7 g			
		Bracket B	14.2 g			
Orifice	1.2 g					
Communication (IO-Link mode)	IO-Link type	Device				
	IO-Link version	V1.1				
	Communication speed	COM2 (38.4 kbps)				
	Configuration file	IODD file*5				
	Min. cycle time	2.3 ms				
	Process data length	Input data: 2 bytes, Output data: 0 byte				
	On request data communication	Yes				
	Data storage function	Yes				
	Event function	Yes				
Vendor ID	131 (0 x 0083)					

*1 Value without digital filter (at 0 ms)

*2 If the applied pressure fluctuates around the set value, the hysteresis must be set to a value more than the amount of fluctuation, or chattering will occur.

*3 Setting is only possible for models with the units selection function. For models without this function, only MPa or kPa is available for the ISE70G/ISE75G, and only MPa is available for the ISE76G/ISE77G/ISE78G.

*4 The response time indicates when the set value is 90% in relation to the step input.

*5 The configuration file can be downloaded from the SMC website, <https://www.smcworld.com>

* Products with tiny scratches, marks, or display color or brightness variations which do not affect the performance of the product are verified as conforming products.

3-Screen Display



IO-Link



UK
CA



High-Precision Digital Pressure Switch: For General Fluids



ISE79S Series

How to Order



ISE79S - 02 - L2 - M

Pressure range

Model	Description
ISE79S	0 to 50 MPa

Piping specification

Symbol	Description
02	Rc1/4
F02	G1/4*1

*1 ISO 1179-1 compliant

Output specification*1

Symbol	Description
L2	IO-Link: Switch output 1 + Switch output 2 (Switch output: NPN or PNP switching type)

*1 Refer to pages 12 and 13 for details.

Unit specification

Symbol	Description
Nil	Units selection function*1
M	SI units only*2

*1 Under the New Measurement Act, switches with the units selection function are no longer allowed for use in Japan.

*2 Fixed units: MPa, kPa

Option 3

Symbol	Description
Nil	Operation manual
Y	None
K	Operation manual + Calibration certificate
T	Calibration certificate

Option 2

Symbol	Description
Nil	None
A	Bracket A (Interchangeable with ISE75(H))
B	Bracket B

Option 1

Symbol	Description
Nil	None
S	Lead wire with M12 connector (Straight, 5 m)
L	Lead wire with M12 connector (Right-angled, 5 m)

Options/Part Nos.

When only optional parts are required, order with the part numbers listed below.

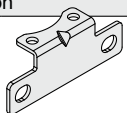
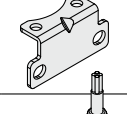
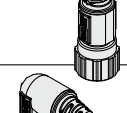
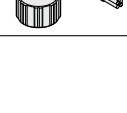
Description	Part no.	Note
Bracket A 	ZS-50-A	Interchangeable with ISE75(H) With 2 mounting screws (M4 x 6 L)
Bracket B 	ZS-50-B	With 2 mounting screws (M4 x 6 L)
Lead wire with M12 connector: Straight 	ZS-31-B	Lead wire length: 5 m
Lead wire with M12 connector: Right-angled 	ZS-31-C	Lead wire length: 5 m



For pressure switch precautions and specific product precautions, refer to the "Operation Manual" on the SMC website.

Specifications

Model		ISE79S		
Applicable fluid		Liquid or gas that will not corrode materials of parts in contact with fluid		
Pressure	Rated pressure range	0 to 50.0 MPa		
	Display/Set pressure range	-2.5 to 52.5 MPa		
	Display/Smallest settable increment	0.1 MPa		
	Withstand pressure	75 MPa		
Power supply	Power supply voltage	When used as a switch output device	12 to 24 VDC $\pm 10\%$ with 10% voltage ripple or less	
		When used as an IO-Link device	18 to 30 VDC, including ripple (p-p) 10%	
	Current consumption	35 mA or less		
Protection	Polarity protection			
Accuracy	Display accuracy	$\pm 2\%$ F.S. ± 1 digit (Ambient temperature of $25 \pm 3^\circ\text{C}$)		
	Repeatability	$\pm 0.5\%$ F.S.		
	Temperature characteristics (25°C standard)	$\pm 5\%$ F.S.		
Switch output (SIO mode)	Output type	Select from NPN or PNP open collector output.		
	Output mode	Hysteresis, Window comparator, Error output, Output OFF		
	Switch operation	Normal output, Reversed output		
	Max. load current	80 mA		
	Max. applied voltage	30 V (NPN output)		
	Internal voltage drop (Residual voltage)	1.5 V or less (at load current of 80 mA)		
	Delay time*1	2 ms or less, variable from 0 to 60 s/0.01 s increments		
	Hysteresis	Hysteresis mode	Variable from 0*2	
		Window comparator mode		
Short circuit protection	Yes			
Display	Unit*3	MPa, kgf/cm ² , bar, psi		
	Display type	LCD		
	Number of screens	3-screen display (Main screen, Sub screen x 2)		
	Display color	Main screen: Red/Green, Sub screen: Orange		
	Number of display digits	Main screen: 4 digits (7 segments), Sub screen: 4 digits (Upper 1 digit 11 segments, 7 segments for other)		
	Indicator light	Lights up when switch output is turned ON (OUT1, OUT2: Orange)		
Digital filter*3,4	Variable from 0 to 30 s/0.01 s increments			
Environmental resistance	Enclosure	IP67		
	Withstand voltage	500 VAC for 1 min between terminals and housing		
	Insulation resistance	1000 M Ω or more (50 VDC measured via megohmmeter) between terminals and housing		
	Fluid temperature range	-5 to 70°C (No condensation or freezing)		
	Operating temperature range	Operating: -5 to 50°C, Stored: -10 to 60°C (No condensation or freezing)		
Operating humidity range	Operating/Stored: 35 to 85% RH (No condensation)			
Standards	UL/CSA (E216656), CE/UKCA marking			
Piping	Port size	Rc1/4, G1/4		
	Materials of parts in contact with fluid	Sensor pressure receiving area: Equivalent to stainless steel 630, Grease-free		
Weight	Body	Port size Rc1/4	144 g	
		Port size G1/4	141 g	
	Option	Lead wire with connector	139 g	
		Bracket A	17.7 g	
		Bracket B	14.2 g	
Communication (IO-Link mode)	IO-Link type	Device		
	IO-Link version	V1.1		
	Communication speed	COM2 (38.4 kbps)		
	Configuration file	IODD file*5		
	Min. cycle time	2.3 ms		
	Process data length	Input data: 2 bytes, Output data: 0 byte		
	On request data communication	Yes		
	Data storage function	Yes		
	Event function	Yes		
	Vendor ID	131 (0 x 0083)		

*1 Value without digital filter (at 0 ms)

*2 If the applied pressure fluctuates around the set value, the hysteresis must be set to a value more than the amount of fluctuation, or chattering will occur.

*3 Setting is only possible for models with the units selection function.

Only MPa is available for models without this function.

*4 The response time indicates when the set value is 90% in relation to the step input.

*5 The configuration file can be downloaded from the SMC website, <https://www.smcworld.com>



* Products with tiny scratches, marks, or display color or brightness variations which do not affect the performance of the product are verified as conforming products.

ISE7□/7□G/79S Series

Set Pressure Range and Rated Pressure Range

Set the pressure within the rated pressure range. The set pressure range is the range of pressure within which switch output can be set. The rated pressure range is the range of pressure that satisfies the specifications (accuracy, linearity, etc.) of the product. Although it is possible to set a value outside the rated pressure range, the specifications cannot be guaranteed even if the value stays within the set pressure range.

Switch		Pressure range								
		-2 MPa	-0.1 MPa	0	1 MPa	2 MPa	5 MPa	10 MPa	15 MPa	50 MPa
For 1 MPa (For Air and General fluids)	ISE70			0	1 MPa					
	ISE70G	-0.105 MPa			1.05 MPa					
For 1.6 MPa (For Air)	ISE71			0	1.6 MPa					
		-0.105 MPa			1.68 MPa					
For 2 MPa (For General fluids)	ISE75G			0	2 MPa					
		-0.105 MPa			2.1 MPa					
For 5 MPa (For General fluids)	ISE76G			0	5 MPa					
		-0.25 MPa			5.25 MPa					
For 10 MPa (For General fluids)	ISE77G			0	10 MPa					
		-0.50 MPa			10.5 MPa					
For 16 MPa (For General fluids)	ISE78G			0	16 MPa					
		-0.80 MPa			16.8 MPa					
For 50 MPa (For General fluids)	ISE79S			0	50 MPa					
		-2.5 MPa			52.5 MPa					

 Rated pressure range of the switch
 Set pressure range of the switch

Internal Circuits and Wiring Examples

When used as a switch output device

* The numbers in the circuit diagrams show the connector pin layout.

Setting of NPN open collector 2 outputs

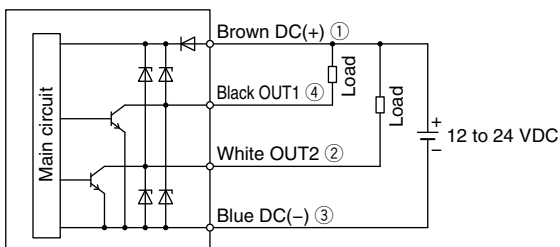

Setting of PNP open collector 2 outputs

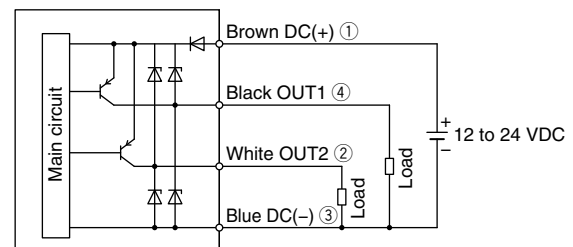

When used as an IO-Link device

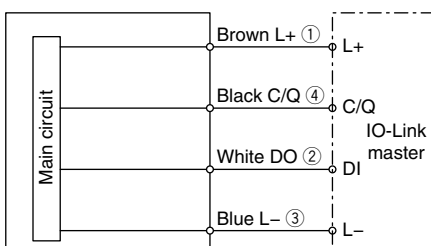

Dimensions

Without bracket

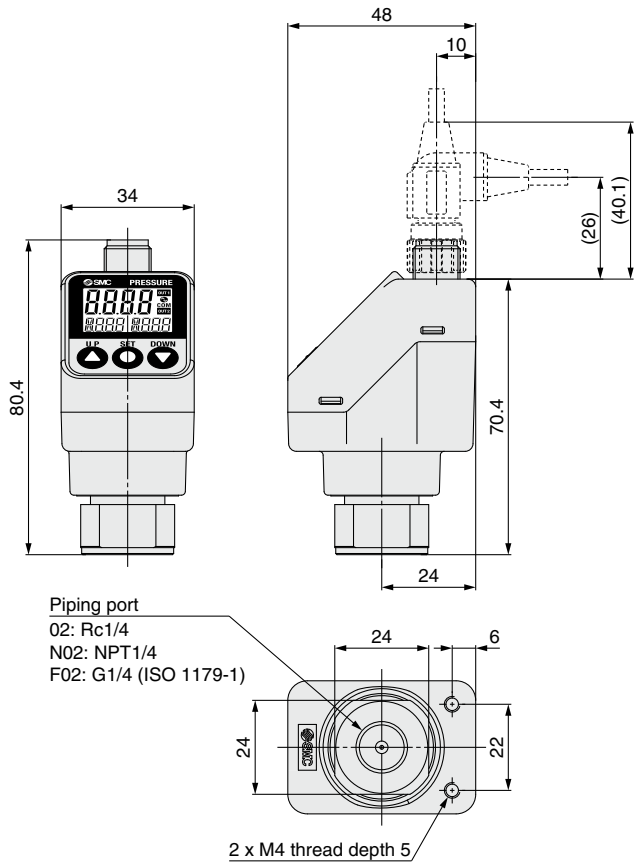

Bracket A (Interchangeable with ISE70/ISE75(H)) (Part no.: ZS-50-A)

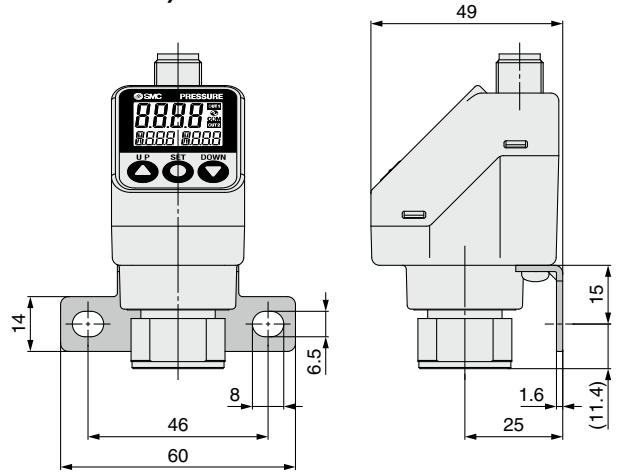

Bracket B (Part no.: ZS-50-B)

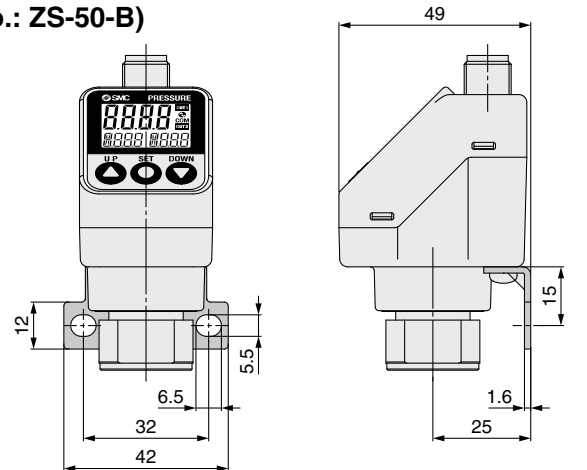

Lead wire with M12 connector (Part no.: ZS-31-B)

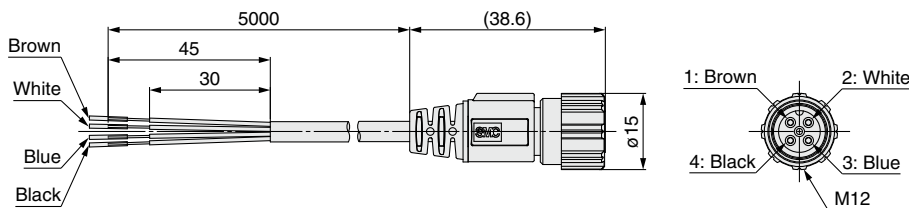

(Part no.: ZS-31-C)

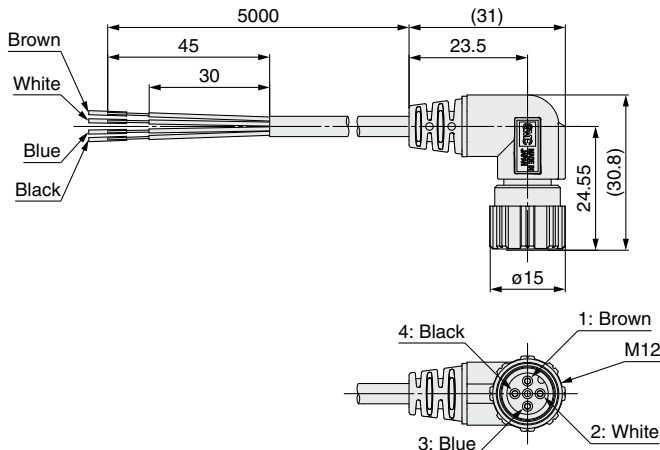

Cable Specifications

Conductor	Nominal cross section	AWG23
	Outside diameter	0.72 mm
Insulator	Material	Cross-linked vinyl chloride
	Outside diameter	1.14 mm
	Number of cores	4
Sheath	Material	Oil-resistant vinyl chloride
	Finished outside diameter	ø4

When used as a switch output device

No.	Description	Lead wire color	Note
1	DC(+)	Brown	12 to 24 VDC
2	OUT2	White	Switch output 2
3	DC(-)	Blue	0 V
4	OUT1	Black	Switch output 1

When used as an IO-Link device

No.	Description	Lead wire color	Note
1	L+	Brown	18 to 30 VDC
2	DO	White	Switch output 2
3	L-	Blue	0 V
4	C/Q	Black	Communication data (IO-Link)/ Switch output 1 (SIO)

ISE7□/7□G/79S Series Function Details

Display examples of the main and sub (set value) screens of each mode.

Hysteresis mode Normal output

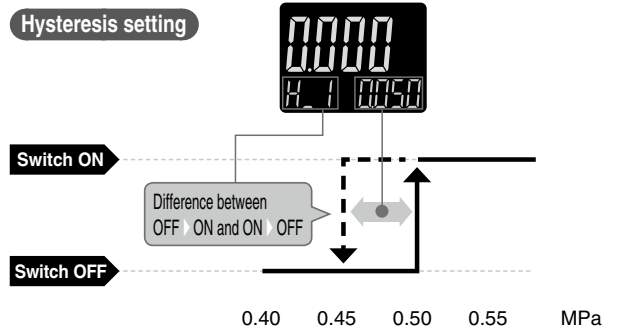
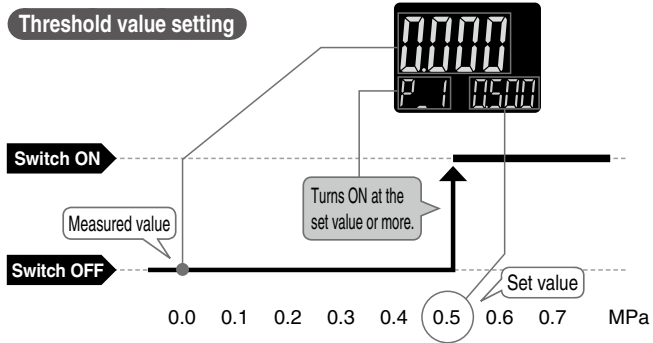

Hysteresis mode Reversed output

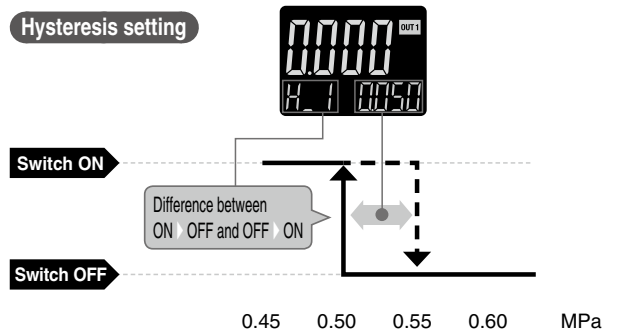
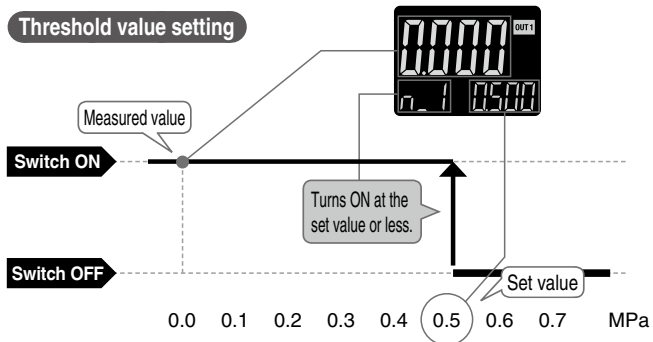

Window comparator mode Normal output

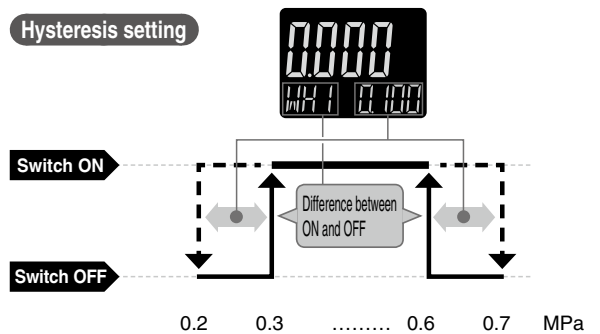
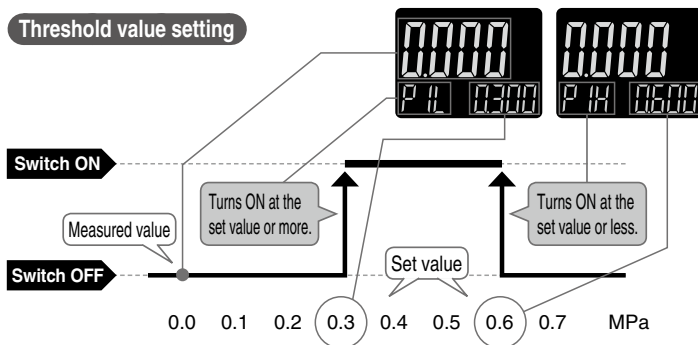

Window comparator mode Reversed output

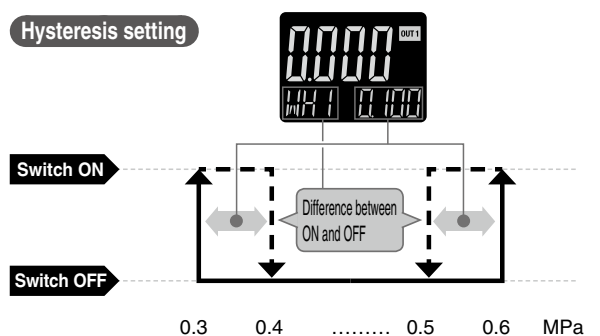
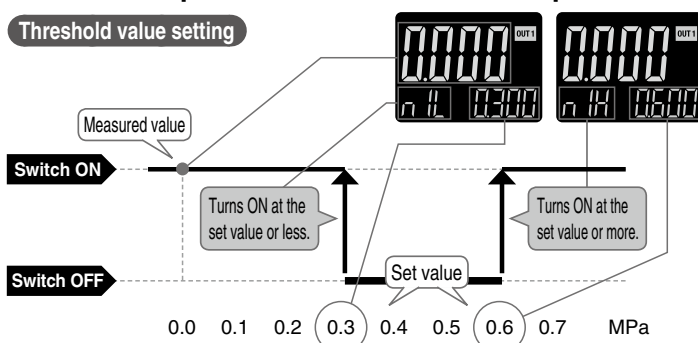

Function Details

A Auto-preset function (F4) * When using with IO-Link, the set values cannot be changed by communication.

This function, when selected in the initial setting, calculates and stores the set value from the measured pressure.

Using this function is possible to automatically determine the optimum set value based on the variation in measured pressure due to the repeated operation of the device.

Formula for Obtaining the Set Value

Set value (Threshold value)	Hysteresis value
$P_{-1}(P_{-2}) = A - (A-B)/4$	$H_{-1}(H_{-2}) = (A-B)/2 $
$n_{-1}(n_{-2}) = B + (A-B)/4$	

A: Max. pressure value in auto-preset mode

B: Min. pressure value in auto-preset mode

B Display value fine adjustment function (F6)

Fine adjustment of the indicated value of the pressure sensor can be made within the range of $\pm 5\%$ of the read value. (This eliminates wide variations of the indicated value.)

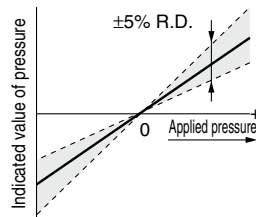

— Indicated value at the time of shipment
 - - - Adjustable range of display value fine adjustment function

* When the display value fine adjustment function is used, the set pressure value may change ± 1 digit.

C Peak/Bottom value indication function

This function constantly detects and updates the max. (min.) pressure when the power is supplied, and allows to hold the max. (min.) pressure value.

The held value is maintained even if the power supply is cut.

When the SET and DOWN buttons are simultaneously pressed for 1 s or longer, while "holding," the held value will be reset.

D Key-lock function

This function prevents operation errors such as accidentally changing setting values.

E Zero-clear function

This function clears and resets the zero value on the display of the measured pressure.

The indicated value can be adjusted within $\pm 7\%$ F.S. of the pressure at the time of shipment from the factory.

F Error display function

When an error or abnormality arises, the location and contents are displayed.

Error name	Display	Description	Action
Over current error		A load current applied to the switch output has exceeded the max. value.	Eliminate the cause of the over current by turning OFF the power supply and then turn it ON again.
Residual pressure error		During zero-clear operation, a pressure over $\pm 7\%$ F.S. has been applied. Note that the mode is returned to measurement mode automatically after 1 s. The zero-clear range varies by $\pm 1\%$ F.S. due to variation between individual products.	Retry the zero-clear operation after restoring the applied pressure to an atmospheric pressure condition.
Applied pressure error		Supply pressure exceeds the max. set pressure.	Reset the applied pressure to a level within the set pressure range.
		Supply pressure is below the min. set pressure.	
System error		An internal data error has occurred.	Turn the power OFF and turn it ON again. If the error cannot be solved, please contact SMC for investigation.
IO-Link master version error		The IO-Link version does not match that of the master. The master uses version 1.0.	Ensure that the master IO-Link version matches the device version.

If the error cannot be solved after the instructions above are performed, or errors other than those above are displayed, please contact SMC for investigation.

Function Details

G Anti-chattering function (Simple setting mode or F1, F2)

A function to delay the switch output response time to prevent chattering or prevent the detection of temporary changes in source pressure. For example, large bore cylinders and ejectors consume a large volume of air during operation and may experience a temporary drop in the supply pressure. The delay time can be set in the range of 0.00 to 60.00 [s] in 0.01 [s] increments.

<Principle>

This function averages pressure values measured during the response time set by the user and then compares the average pressure value with the pressure set point value to output the result on the switch.

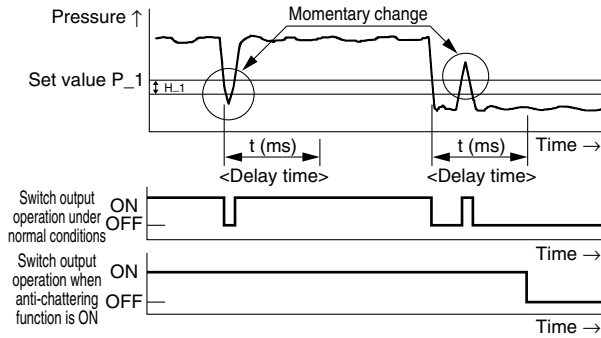

H Units selection function (F0)

Display units can be switched with this function.

Model	Rated pressure range	Smallest settable increment				
		MPa	kPa	kgf/cm ²	bar	psi
ISE70/70G	0 to 1 MPa	0.001	1	0.01	0.01	0.1
ISE71	0 to 1.6 MPa					0.2
ISE75G	0 to 2 MPa	0.01	/	0.1	0.1	1
ISE76G	0 to 5 MPa					
ISE77G	0 to 10 MPa					
ISE78G	0 to 16 MPa	0.1	/	1	1	10
ISE79S	0 to 50 MPa					

I Zero cut-off setting (F14)

When the pressure display value is close to zero, this function forces the display to zero.

The range to display zero can be changed within the range of 0.0 to 10.0%.

Example: When the ISE70 (1 MPa range), zero-cut value = 1.0%, 0 is displayed in the range of -9 to 9 kPa.

J Power saving mode (F80)

The power saving mode can be selected.

With this function, if no buttons are pressed for 30 s, it shifts to power saving mode.

At the time of shipment from the factory, the product is set to the normal mode (the power saving mode is turned OFF).

(During power saving mode, [ECo] will flash in the sub screen and the operation light will be ON (only when the switch is ON).)

K Setting of a security code (F81)

The user can select whether a security code must be entered to release the key lock.

At the time of shipment from the factory, it is set such that a security code is not required.

Safety Instructions

These safety instructions are intended to prevent hazardous situations and/or equipment damage. These instructions indicate the level of potential hazard with the labels of “**Caution**,” “**Warning**” or “**Danger**.” They are all important notes for safety and must be followed in addition to International Standards (ISO/IEC)*1), and other safety regulations.

 **Caution:** **Caution** indicates a hazard with a low level of risk which, if not avoided, could result in minor or moderate injury.

 **Warning:** **Warning** indicates a hazard with a medium level of risk which, if not avoided, could result in death or serious injury.

 **Danger :** **Danger** indicates a hazard with a high level of risk which, if not avoided, will result in death or serious injury.

*1) ISO 4414: Pneumatic fluid power – General rules relating to systems.
ISO 4413: Hydraulic fluid power – General rules relating to systems.
IEC 60204-1: Safety of machinery – Electrical equipment of machines.
(Part 1: General requirements)
ISO 10218-1: Manipulating industrial robots – Safety.
etc.

Warning

1. The compatibility of the product is the responsibility of the person who designs the equipment or decides its specifications.

Since the product specified here is used under various operating conditions, its compatibility with specific equipment must be decided by the person who designs the equipment or decides its specifications based on necessary analysis and test results. The expected performance and safety assurance of the equipment will be the responsibility of the person who has determined its compatibility with the product. This person should also continuously review all specifications of the product referring to its latest catalog information, with a view to giving due consideration to any possibility of equipment failure when configuring the equipment.

2. Only personnel with appropriate training should operate machinery and equipment.

The product specified here may become unsafe if handled incorrectly. The assembly, operation and maintenance of machines or equipment including our products must be performed by an operator who is appropriately trained and experienced.

3. Do not service or attempt to remove product and machinery/equipment until safety is confirmed.

1. The inspection and maintenance of machinery/equipment should only be performed after measures to prevent falling or runaway of the driven objects have been confirmed.
2. When the product is to be removed, confirm that the safety measures as mentioned above are implemented and the power from any appropriate source is cut, and read and understand the specific product precautions of all relevant products carefully.
3. Before machinery/equipment is restarted, take measures to prevent unexpected operation and malfunction.

4. Contact SMC beforehand and take special consideration of safety measures if the product is to be used in any of the following conditions.

1. Conditions and environments outside of the given specifications, or use outdoors or in a place exposed to direct sunlight.
2. Installation on equipment in conjunction with atomic energy, railways, air navigation, space, shipping, vehicles, military, medical treatment, combustion and recreation, or equipment in contact with food and beverages, emergency stop circuits, clutch and brake circuits in press applications, safety equipment or other applications unsuitable for the standard specifications described in the product catalog.
3. An application which could have negative effects on people, property, or animals requiring special safety analysis.
4. Use in an interlock circuit, which requires the provision of double interlock for possible failure by using a mechanical protective function, and periodical checks to confirm proper operation.

Caution

1. The product is provided for use in manufacturing industries.

The product herein described is basically provided for peaceful use in manufacturing industries.
If considering using the product in other industries, consult SMC beforehand and exchange specifications or a contract if necessary.
If anything is unclear, contact your nearest sales branch.

Limited warranty and Disclaimer/ Compliance Requirements

The product used is subject to the following “Limited warranty and Disclaimer” and “Compliance Requirements”.

Read and accept them before using the product.

Limited warranty and Disclaimer

1. The warranty period of the product is 1 year in service or 1.5 years after the product is delivered, whichever is first.*2)
Also, the product may have specified durability, running distance or replacement parts. Please consult your nearest sales branch.
2. For any failure or damage reported within the warranty period which is clearly our responsibility, a replacement product or necessary parts will be provided.
This limited warranty applies only to our product independently, and not to any other damage incurred due to the failure of the product.
3. Prior to using SMC products, please read and understand the warranty terms and disclaimers noted in the specified catalog for the particular products.

*2) Vacuum pads are excluded from this 1 year warranty.

A vacuum pad is a consumable part, so it is warranted for a year after it is delivered.
Also, even within the warranty period, the wear of a product due to the use of the vacuum pad or failure due to the deterioration of rubber material are not covered by the limited warranty.

Compliance Requirements

1. The use of SMC products with production equipment for the manufacture of weapons of mass destruction (WMD) or any other weapon is strictly prohibited.
2. The exports of SMC products or technology from one country to another are governed by the relevant security laws and regulations of the countries involved in the transaction. Prior to the shipment of a SMC product to another country, assure that all local rules governing that export are known and followed.

Caution

SMC products are not intended for use as instruments for legal metrology.

Measurement instruments that SMC manufactures or sells have not been qualified by type approval tests relevant to the metrology (measurement) laws of each country. Therefore, SMC products cannot be used for business or certification ordained by the metrology (measurement) laws of each country.

Revision History

Edition B	* The ISE7□G for general fluids has been added. * Number of pages has been increased from 12 to 16. * The ISE78G for general fluids has been added. * Number of pages has been increased from 16 to 20.	WQ
Edition C	* The ISE79S for general fluids has been added.	AT

 **Safety Instructions** Be sure to read the “Handling Precautions for SMC Products” (M-E03-3) and “Operation Manual” before use.

SMC Corporation

Akihabara UDX 15F,
4-14-1, Sotokanda, Chiyoda-ku, Tokyo 101-0021, JAPAN
Phone: 03-5207-8249 Fax: 03-5298-5362
<https://www.smcworld.com>
© 2022 SMC Corporation All Rights Reserved

Specifications are subject to change without prior notice and any obligation on the part of the manufacturer.

D-G