

**3-Color Display**



# Electromagnetic Digital Flow Switch

**Applicable fluid** Water, Water-soluble coolant

**IP65**

## Compact

The oval fluid passage enables the width to be reduced.

**Lightweight**

**340 g**  
(LFE1□3)

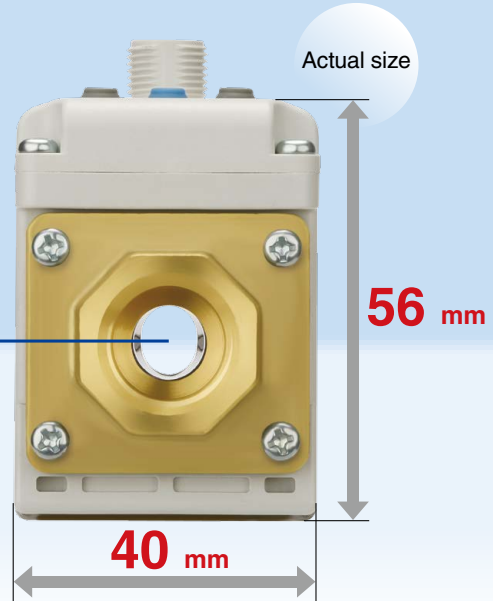

**New**

An isolated type has been added.

- Positive ground
- Negative ground

2 types of ground are available.





A close proximity setting is available.

- Fluctuation of the displayed value can be reduced when the close proximity setting function is used.
- Reduced setting time

\* Not available for the remote type



## Variations

Integrated display type/Remote type	Flow range							
	0.5 L/min	2 L/min	5 L/min	10 L/min	20 L/min	50 L/min	100 L/min	200 L/min
 LFE1 LFE1□Z					Rated flow range		Display flow range	
 LFE2 LFE2□Z						Rated flow range		Display flow range
 LFE3 LFE3□Z				Display flow range				Rated flow range

**LFE□ Series**



CAT.ES100-107D <sup>Ⓐ</sup>

**New** An isolated type has been added.

The ground doesn't need to be selected when wiring.

Marking (Blue)



**Isolated type/LFE□Z**

The piping port is isolated with the power supply.

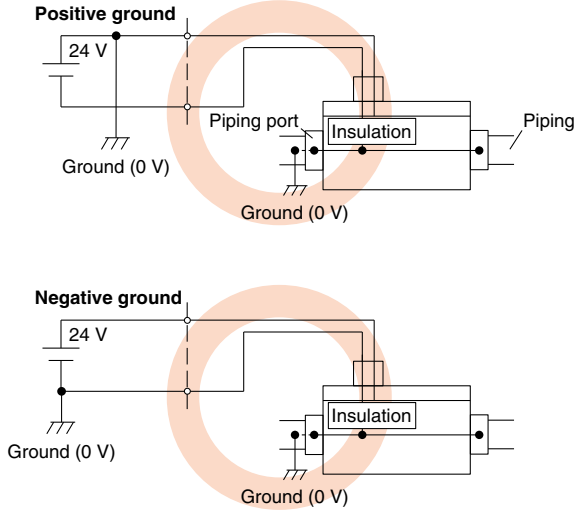

**Non-isolated type/LFE□**

The piping port is connected to the negative ground of the power supply.

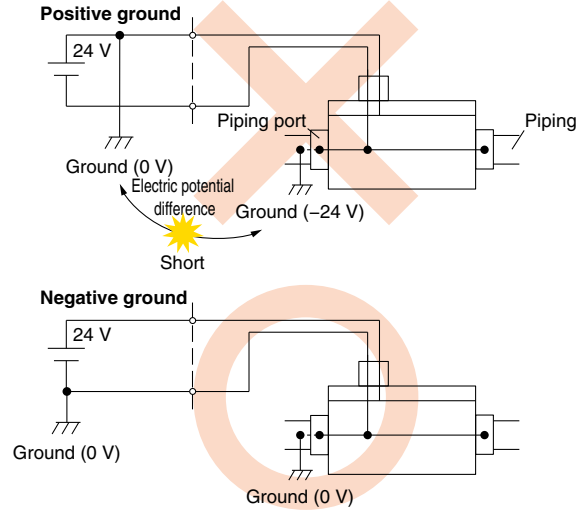

**Pressure loss: 0.02 MPa or less**

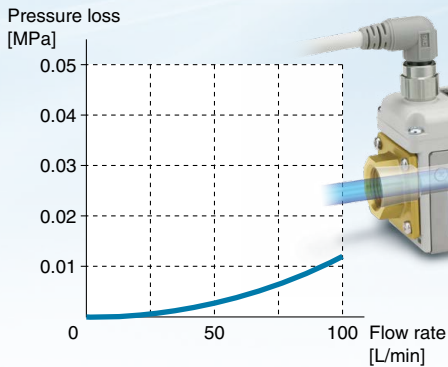

**Reverse flow can be detected.**

Reverse flow error display



**Repeatability: ±1.5% F.S.**

(Analog output)

**Operating fluid temperature: 0 to 85°C**

**Made to Order**

Piping connection ports: Stainless steel 304



**A zero-reset setting is available.**

The display can be adjusted to zero.

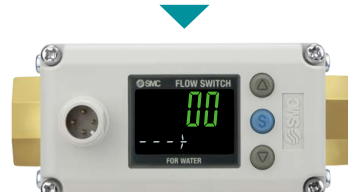
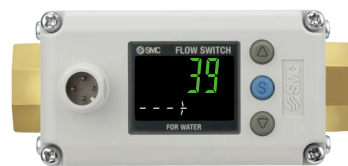

\* Integrated display type only

## Flow direction can be changed after installation.

- Default flow direction (Forward direction)



- Flow direction can be changed after installation.

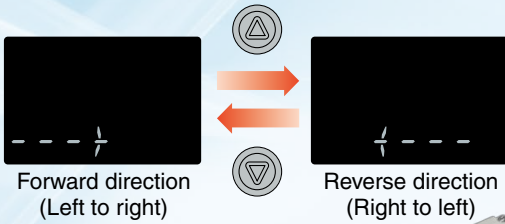

## 3-color/2-screen display

Instantaneous flow rate is displayed.



The parameters below can be set.

- Set value
- Flow direction
- Accumulated value
- Line name
- Peak/Bottom value

## Application Examples

Flow control for pressurized cooling water for welding guns

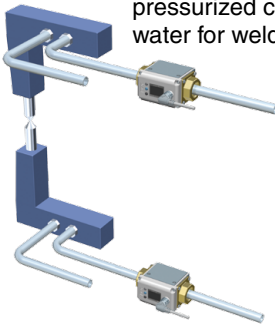

Flow control for water-soluble coolant

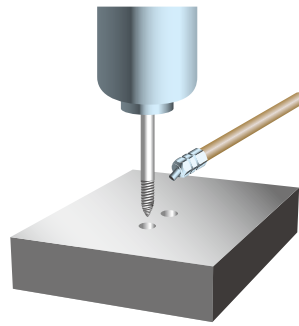

Flow control for cooling water for metal molds

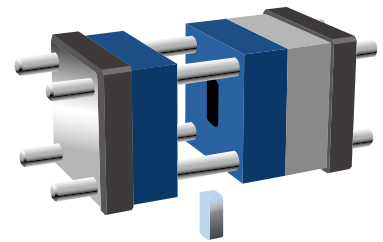

## Principle

### Faraday's law of induction





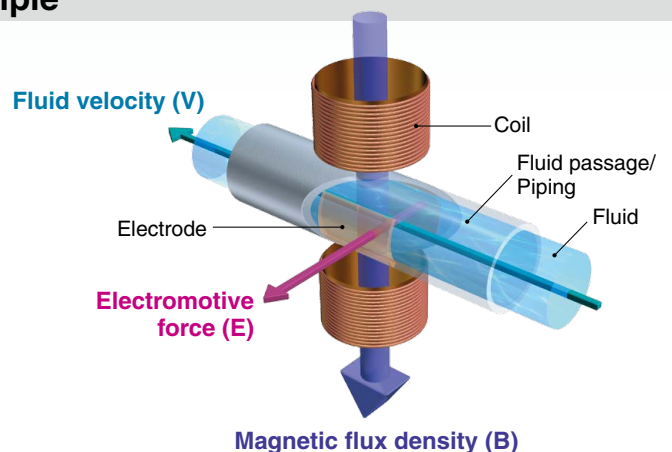

Measure the volume flow of inductive liquids by applying Faraday's law of induction: "when a conductive object is moved through a magnetic field, an electromotive force will be generated."

The **electromotive force (E)** is proportional to the **fluid velocity (V)** multiplied by the **magnetic flux density (B)**. The volume flow is calculated by converting the measured **electromotive force (E)**.

An oval fluid passage is used to improve the **magnetic flux density (B)** generated by small amounts of current.



# Flow Switch for Fluid Variations

Series	Applicable fluid	Detection method	Smallest settable increment	Enclosure <sup>*1</sup>	Display	Rated flow range [L/min]										
						0	0.5	2	5	10	20	30	40	50	100	150
<b>LFE</b> 	Water, Water-soluble coolant	Electromagnetic	0.1 L/min	IP65	3-color display	0.5	20									
			0.5 L/min			2.5	100									
			1 L/min			5	200									
<b>PF3W-Z</b> 	Water, Ethylene glycol aqueous solution	Karman vortex	0.01 L/min	IP65	3-color display	0.5	4									
			0.1 L/min			2	16									
			0.1 L/min			5	40									
			1 L/min			10	100									
<b>PF3W-L-Z</b> 	Water, Ethylene glycol aqueous solution	Karman vortex	0.01 L/min	IP65	3-color display	0.5	4									
			0.1 L/min			2	16									
			0.1 L/min			5	40									
			1 L/min			10	100									
<b>PF3W721-L</b> 	Water, Ethylene glycol aqueous solution	Karman vortex	2 L/min	IP65	3-color display						50	250				
<b>PF3W</b> 	Water, Ethylene glycol aqueous solution	Karman vortex	0.01 L/min	IP65	3-color display	0.5	4									
			0.1 L/min			2	16									
			0.1 L/min			5	40									
			1 L/min			10	100									
			2 L/min								50	250				
<b>PVC piping type</b> 	Water, Ethylene glycol aqueous solution	Karman vortex	1 L/min	IP65	3-color display					10	100					
			2 L/min						30	250						
<b>PF2D</b> 	Deionized water (pure water), Liquids which do not corrode nor erode fluoropolymer	Karman vortex	0.05 L/min	IP65	1-color display	0.4	4									
			0.1 L/min			1.8	20									
			0.5 L/min			4	40									

\*1 For the remote type monitor unit, only the front side is IP65 compliant. The other parts are IP40 compliant.



# CONTENTS

## **3-Color Display** Electromagnetic Digital Flow Switch *LFE Series*

## **3-Color Display** Digital Flow Monitor *LFE0 Series*

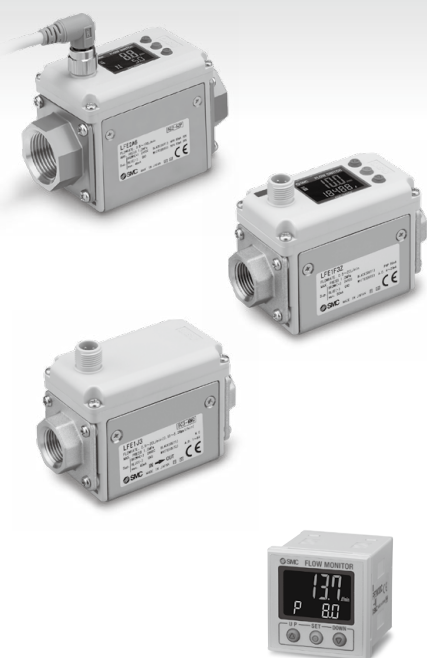

### **3-Color Display** Electromagnetic Digital Flow Switch *LFE Series*

How to Order .....	p. 5
Specifications (Integrated Display Type) .....	p. 6
Specifications (Remote Type) .....	p. 7
Flow Rate Characteristics (Pressure Loss) .....	p. 8
Internal Circuits and Wiring Examples .....	p. 9
Parts Description .....	p. 10
Fluid Passage Structure .....	p. 10
Dimensions .....	p. 11

### **3-Color Display** Digital Flow Monitor *LFE0 Series*

How to Order .....	p. 12
Specifications (Remote Type Monitor) .....	p. 13
Internal Circuits and Wiring Examples .....	p. 14
Parts Description (Remote Type Monitor) .....	p. 15
Dimensions .....	p. 16

Function Details .....	p. 17
Made to Order .....	p. 19
Specific Product Precautions .....	p. 20
Safety Instructions .....	Back cover

# 3-Color Display



## Electromagnetic Digital Flow Switch



# LFE Series

Integrated display type

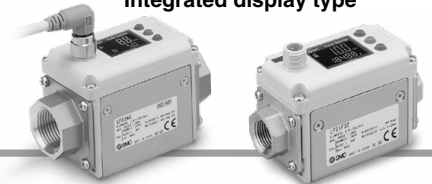

### How to Order

Non-isolated type

Isolated type



Remote type

Remote type monitor

(For details, refer to page 12.)

### Isolated type

The piping port is isolated with the power supply.

LFE 1 A 3 [ ] [ ] Z - [ ]

### Non-isolated type

The piping port is connected to the negative ground of the power supply.

LFE 1 A 3 [ ] [ ] - [ ]

**Rated flow range**

Symbol	Rated flow range
1	0.5 to 20 L/min
2	2.5 to 100 L/min
3	5 to 200 L/min

• Made to order (Refer to page 19.)

Symbol	Description
X8	Piping connection ports: Stainless steel 304

### Output specifications

	Symbol	OUT1	OUT2	Isolated type	Non-isolated type
Integrated display type	A	NPN	NPN	●	●
	B	PNP	PNP	●	●
	C	NPN	Analog 1 to 5 V	●	●
	D	NPN	Analog 4 to 20 mA	●	●
	E	PNP	Analog 1 to 5 V	●	—
	F	PNP	Analog 4 to 20 mA	●	—
Remote type	J*1	—	Analog 1 to 5 V	●	●
	K*2	—	Analog 4 to 20 mA	●	●

\*1 J: Select when used in combination with a digital flow monitor.  
\*2 K: Cannot be used in combination with a digital flow monitor

### Option

Symbol	Lead wire and M12 connector (Length 3 m)	Bracket	Display unit
Nil	●	—	L/min
1	—	—	L/min
2	●	●	L/min
3	—	●	L/min
4*1*2	●	—	gal/min
5*1*2	—	—	gal/min
6*1*2	●	●	gal/min
7*1*2	—	●	gal/min

\*1 Options 4, 5, 6, and 7, which are not in SI units, are not for use in Japan due to the New Measurement Act.  
\*2 Options 4, 5, 6, and 7 cannot be selected when the output specification is J or K.  
Reference: 1 [L/min] = 0.2642 [gal/min]  
1 [gal/min] = 3.785 [L/min]

### Port size

Symbol



Symbol	Port size	Applicable model		
		LFE1	LFE2	LFE3
3	3/8	●	—	—
4	1/2	●	—	—
6	3/4	—	●	—
8	1	—	—	●

### Thread type

Symbol	Type
Nil	Rc
N	NPT
F	G

The close proximity setting and zero-reset functions are only available for the integrated display type.  
For the remote type, the close proximity setting and zero-reset functions cannot be used.

## Options/Part Nos.

When only optional parts are required, order with the part numbers listed below.

Option	Part no.	Note	Weight
Lead wire and M12 connector	LFE-1-A3	Lead wire length 3 m	Approx. 175 g

Option	Part no.	Note	Weight
Bracket	LFE-1-D	Tapping screw for LFE1 (3 x 10), 4 pcs.	Approx. 45 g
	LFE-2-D	Tapping screw for LFE2 (3 x 10), 4 pcs.	Approx. 70 g
	LFE-3-D	Tapping screw for LFE3 (3 x 10), 4 pcs.	Approx. 70 g

For flow switch precautions, refer to the Operation Manual on the SMC website.

## Specifications (Integrated Display Type)

Model		LFE1	LFE2	LFE3
<b>Applicable fluid</b> *1		Water, Conductive fluids which do not corrode the fluid contact materials*1		
<b>Applicable fluid conductivity</b> *1		5 μS/cm or more (micro siemens)		
<b>Detection method</b>		Electrostatic capacity		
<b>Rated flow range</b> *10		0.5 to 20 L/min	2.5 to 100 L/min	5 to 200 L/min
<b>Display flow range</b>		0.4 to 24.0 L/min	2.0 to 120.0 L/min	4 to 240 L/min
<b>Set flow range</b>		0.4 to 24.0 L/min	2.0 to 120.0 L/min	4 to 240 L/min
<b>Zero-cut flow</b> *2		0.4 L/min	2.0 L/min	4 L/min
<b>Smallest settable increment</b>		0.1 L/min	0.5 L/min	1 L/min
<b>Accumulated volume per pulse (Pulse width: 50 ms)</b>		0.1 L/pulse	0.5 L/pulse	1 L/pulse
<b>Operating fluid temperature</b> *3		0 to 85°C (No freezing or condensation)		
<b>Display units</b>		Instantaneous flow rate L/min, Accumulated flow L		
<b>Repeatability</b>		Displayed values: ±2% F.S. Analog output: ±1.5% F.S.		
<b>Temperature characteristics</b>	<b>Ambient temperature</b>	±5% F.S. (25°C reference)		
	<b>Fluid temperature</b>	±5% F.S. (25°C reference)		
<b>Operating pressure range</b> *3		0 to 1 MPa		
<b>Proof pressure</b> *3		2 MPa		
<b>Accumulated flow range</b> *4		99999999.9 L by 0.1 L	999999999 L by 1 L	
<b>Switch output</b>		NPN or PNP open collector output		
	<b>Maximum load current</b>	80 mA		
	<b>Maximum applied voltage</b>	28 VDC		
	<b>Internal voltage drop</b>	NPN: 1 V or less (at load current of 80 mA) PNP: 1.5 V or less (at load current of 80 mA)		
	<b>Response time</b> *5*7	Can be selected from 0.25 s, 0.5 s, 1 s, 2 s, or 5 s		
	<b>Output protection</b>	Short-circuit protection		
	<b>Output mode</b>	Select from hysteresis mode, window comparator mode, accumulated output mode, or accumulated pulse output mode.		
<b>Analog output</b>	<b>Response time</b> *6*7	Linked with the switch output		
	<b>Voltage output</b>	Output voltage: 1 to 5 V Output impedance: 1 kΩ		
	<b>Current output</b>	Output current: 4 to 20 mA Max. load impedance: 600 Ω		
<b>Hysteresis</b>		Variable		
<b>Display method</b>		2-screen (Main screen: 4-digit, 7-segment, 2-color, Red/Green; Sub screen: 6-digit, 11-segment, White) Display values updated 5 times per second		
<b>Status LED</b>		Output 1, Output 2: Orange		
<b>Power supply voltage</b>		24 VDC ±10%		
<b>Current consumption</b>		LFE□: 45 mA or less/LFE□Z: 60 mA or less (Both not including load current)		
<b>Environmental resistance</b>	<b>Enclosure</b> *9	IP65		
	<b>Operating temperature range</b>	0 to 50°C (No freezing or condensation)		
	<b>Operating humidity range</b>	Operating, Storage: 35 to 85% R.H. (No condensation)		
<b>Standards and regulations</b>		CE/UKCA marking (EMC Directive, RoHS Directive)		
<b>Fluid contact materials</b>		PPS, FKM, Brass		
<b>Port size</b>		3/8 (10A)	1/2 (15A)	3/4 (20A)
<b>Weight (Body)</b> *8	<b>Insulated type</b>	Approx. 340 g	Approx. 400 g	Approx. 520 g
	<b>Non-insulated type</b>			Approx. 680 g

\*1 Refer to the "Applicable Fluids List" on page 22.

\*2 0 L/min is displayed when the flow is less than the zero-cut flow.

\*3 When fluids with high temperatures are used, the operating pressure range and proof pressure will be reduced. (For details, refer to the "Operating Pressure Range" on page 8.)

\*4 It is cleared when the power supply is turned OFF. A hold function can be selected. (Intervals of 2 or 5 minutes can be selected.) If 5-minute intervals are selected, the life of the memory element (electronic parts) is limited to 1 million times. (If energized for 24 hours, life is calculated as 5 minutes x 1 million = 5 million minutes = about 9.5 years.) Therefore, calculate the number of operations and use within the life.

\*5 The delay time until the set value reaches 63% in relation to the step input

\*6 The delay time until the set value reaches 63% in relation to the step input

There might be a 0.05 s delay at response times of 0.25 s and 0.5 s due to the timing of internal processing.

\*7 The stability of the display and analog output can be improved by increasing the response time of the switch output. (For details, refer to the "Stability" on page 8.)

\*8 When options are used, add the weight of the optional parts.

\*9 The enclosure refers to the digital flow switch with a lead wire and M12 connector.

\*10 This is the flow range in which the product specifications (accuracy, repeatability, etc.) are satisfied. The correct values may not be displayed when operated outside of the rated flow range.

For flow switch precautions, refer to the Operation Manual on the SMC website.

## Specifications (Remote Type) \* Refer to page 12 for monitor specifications.

Model		LFE1	LFE2	LFE3
Applicable fluid*1		Water, Conductive fluids which do not corrode the fluid contact materials*1		
Applicable fluid conductivity*1		5 μS/cm or more (micro siemens)		
Detection method		Electrostatic capacity		
Rated flow range*5		0.5 to 20 L/min	2.5 to 100 L/min	5 to 200 L/min
Operating fluid temperature*2		0 to 85°C (No freezing or condensation)		
Repeatability		Analog output: ±1.5% F.S.		
Temperature characteristics	Ambient temperature	±5% F.S. (25°C reference)		
	Fluid temperature	±5% F.S. (25°C reference)		
Operating pressure range*2		0 to 1 MPa		
Proof pressure*2		2 MPa		
Analog output	Response time*3	0.5 s		
	Voltage output	Output voltage: 1 to 5 V Output impedance: 1 kΩ		
	Current output	Output current: 4 to 20 mA Max. load impedance: 600 Ω		
Power supply voltage		24 VDC ±10%		
Current consumption		LFE□: 42 mA or less/LFE□Z: 55 mA or less (Both not including load current)		
Environmental resistance	Enclosure*6	IP65		
	Operating temperature range	0 to 50°C (No freezing or condensation)		
	Operating humidity range	Operating, Storage: 35 to 85% R.H. (No condensation)		
Standards and regulations		CE/UKCA marking (EMC Directive, RoHS Directive)		
Fluid contact materials		PPS, FKM, Brass		
Port size		3/8 (10A)	1/2 (15A)	3/4 (20A)
Weight (Body)*4	Insulated type	Approx. 335 g	Approx. 395 g	Approx. 515 g
	Non-insulated type			

\*1 Refer to the "Applicable Fluids List" on page 22.

\*2 When fluids with high temperatures are used, the operating pressure range and proof pressure will be reduced. (For details, refer to the "Operating Pressure Range" on page 8.)

\*3 The delay time until the set value reaches 63% in relation to the step input. There might be a 0.05 s delay due to the timing of internal processing.

\*4 When options are used, add the weight of the optional parts.

\*5 This is the flow range in which the product specifications (accuracy, repeatability, etc.) are satisfied. The correct values may not be displayed when operated outside of the rated flow range.

\*6 The enclosure refers to the digital flow switch with a lead wire and M12 connector.

## Analog Output

### Flow/Analog output

	A	B	C
Voltage output	1 V	1.1 V	5 V
Current output	4 mA	4.4 mA	20 mA

Model	Rated flow [L/min]	
	Minimum	Maximum
LFE1	0.5	20
LFE2	2.5	100
LFE3	5	200

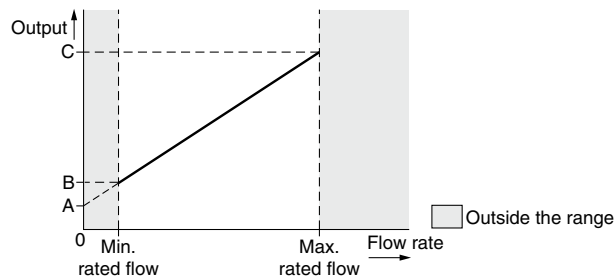



### Flow Rate Characteristics (Pressure Loss)

**LFE1**

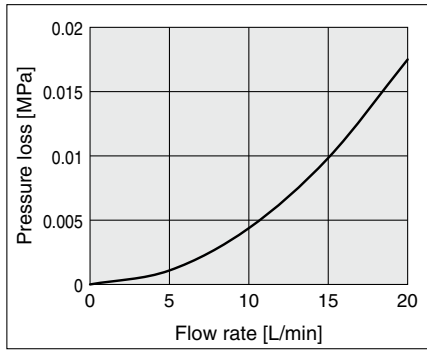

**LFE2**

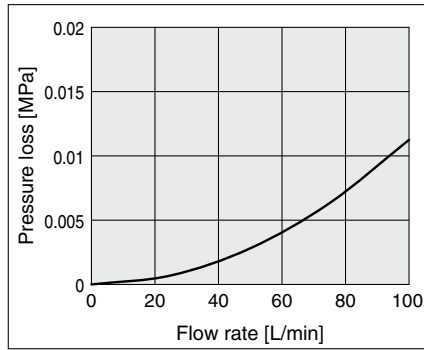

**LFE3**

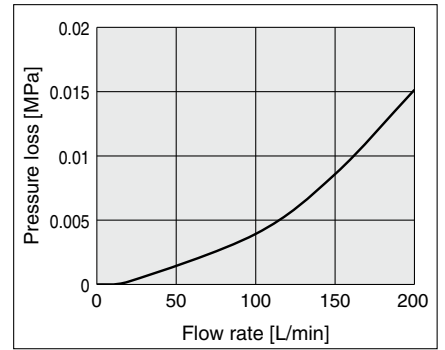

### Straight Piping Length and Accuracy (Reference Value)

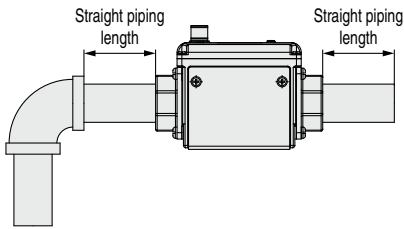

**[Measurement conditions]**

Fluid: Tap water  
Pressure: 0.2 MPa

**[Port size]**

LFE1: 3/8 inch  
LFE2: 3/4 inch  
LFE3: 1 inch

#### Accuracy change

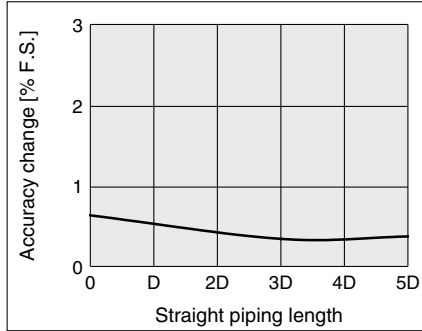

- The smaller the piping size, the more the product is affected by the straight piping length. The straight piping length should be 5 times (5D) or more the piping size to achieve the stable measurement.

Model	Straight piping length [mm]	
	D	5D
LFE1	11	55
LFE2	21	105
LFE3	27	135

### Stability

- \* Stability is improved by increasing the response time setting.
- \* Stability indicates the fluctuation width of the display or analog output.

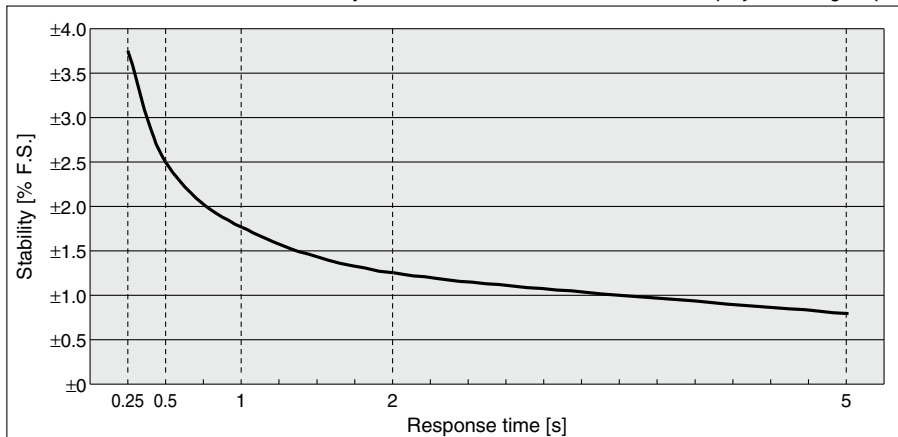

### Operating Pressure Range

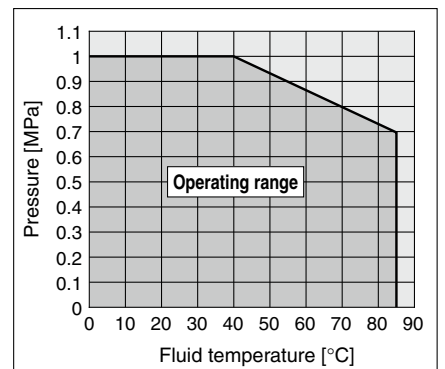

When fluids with high temperature are used, the operating pressure range will be reduced. Operate within the range mentioned above. The proof pressure is double the operating pressure range.

# LFE Series

## Internal Circuits and Wiring Examples (Integrated Display Type)

### NPN 2 output type LFE□A□□□(Z)

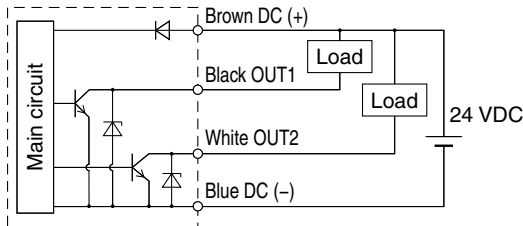

Max. 28 V, 80 mA  
Internal voltage drop 1 V or less

### PNP 2 output type LFE□B□□□(Z)

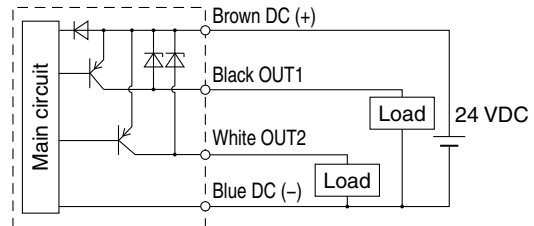

Max. 80 mA  
Internal voltage drop 1.5 V or less

### NPN + Analog output type LFE□C□□□(Z)/LFE□D□□□(Z)

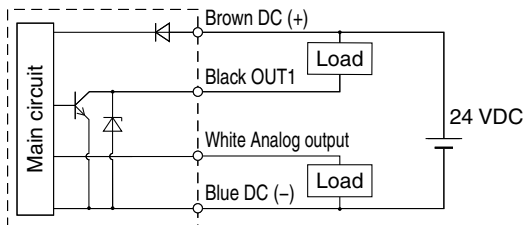

Max. 28 V, 80 mA  
Internal voltage drop 1 V or less  
C: Analog output 1 to 5 V  
Output impedance 1 kΩ  
D: Analog output 4 to 20 mA  
Load impedance 50 to 600 Ω

### PNP + Analog output type LFE□E□□□Z/LFE□F□□□Z

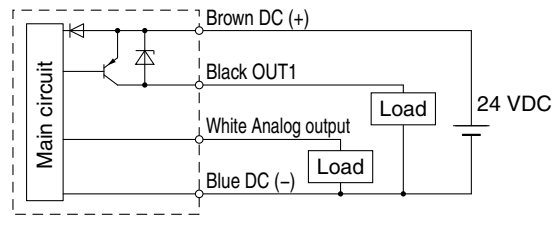

Max. 80 mA  
Internal voltage drop 1.5 V or less  
E: Analog output 1 to 5 V  
Output impedance 1 kΩ  
F: Analog output 4 to 20 mA  
Load impedance 50 to 600 Ω

## Accumulated pulse output wiring examples

### NPN 2 output type LFE□A□□□(Z)

### NPN + Analog output type LFE□C□□□(Z)/LFE□D□□□(Z)

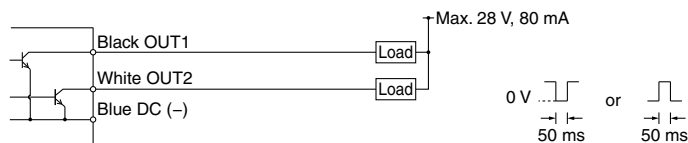

### PNP 2 output type LFE□B□□□(Z)

### PNP + Analog output type LFE□E□□□Z/LFE□F□□□Z

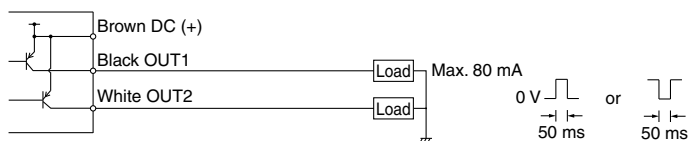

\* OUT2 is available for 2 output types (A or B).  
When accumulated pulse output is selected, the indicator light will be OFF.

## Internal Circuits and Wiring Examples (Remote Type)

### Analog voltage output type LFE□J□□□(Z)

### Analog current output type LFE□K□□□(Z)

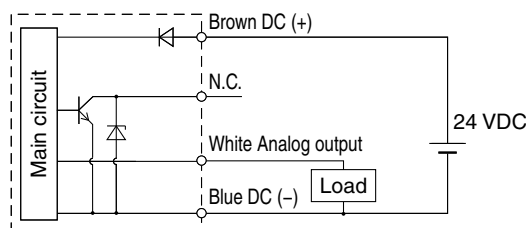

\* Do not connect anything to N.C.

\* For both the remote type and the integrated display type, the output part of the isolated type is isolated with the main circuit.

## Parts Description

### Body

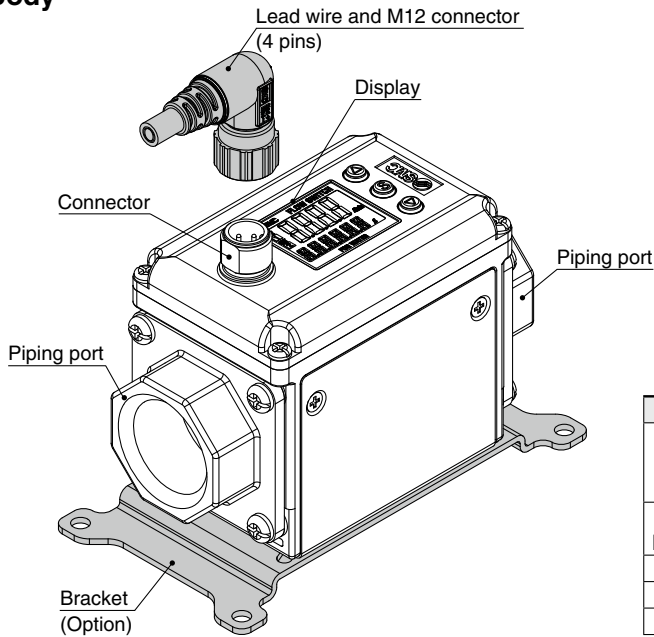

Description	Function
Connector	Allows for power supply connection by connecting to the lead wire with M12 connector and performs output according to the flow rate
Lead wire and M12 connector	The enclosure becomes IP65 when fit with a connector.
Piping port	For piping connections
Display	Displays the flow, set values, and error information
Bracket	Mounting bracket for installing the product

### Display

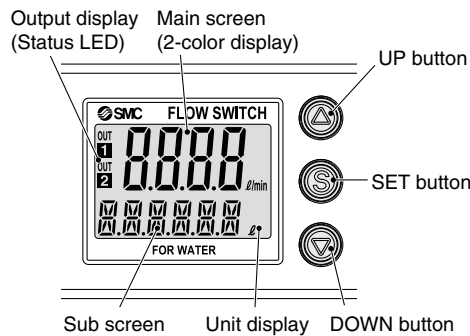

Description	Function
Main screen (2-color display)	Displays the flow value, setting mode, and error codes
Sub screen	Displays the accumulated flow, peak/bottom value, flow direction, and various setting values (For details, refer to page 17.)
Output display (Status LED)	Displays the output condition of OUT1 and OUT2 (When ON: Orange light turns on)
UP/DOWN button	Changes the selected items and increases or decreases the set value
SET button	Makes changes in each mode and enters the set value
Unit display	Indicates the unit currently selected

## Fluid Passage Structure

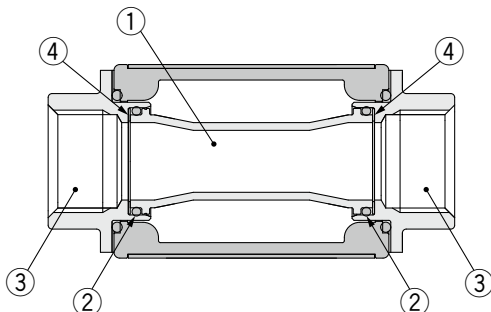

No.	Description	Material
1	Pipe	PPS
2	O-ring	FKM
3	Attachment	Brass
4	Spacer	FKM

# LFE Series

## Dimensions

### Integrated display type LFE1/2/3(Z)

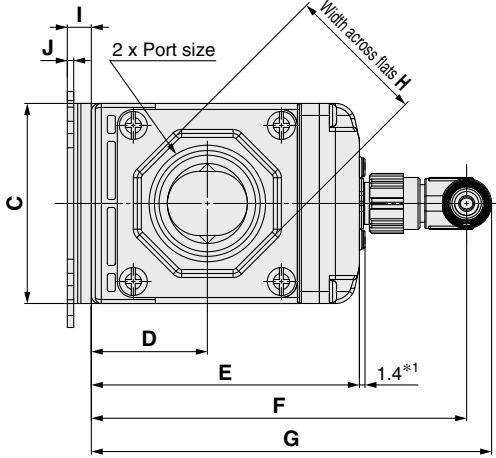

\*1 For the integrated display type

\* The electrical entry for the lead wire and M12 connector does not rotate and is limited to only one entry direction.

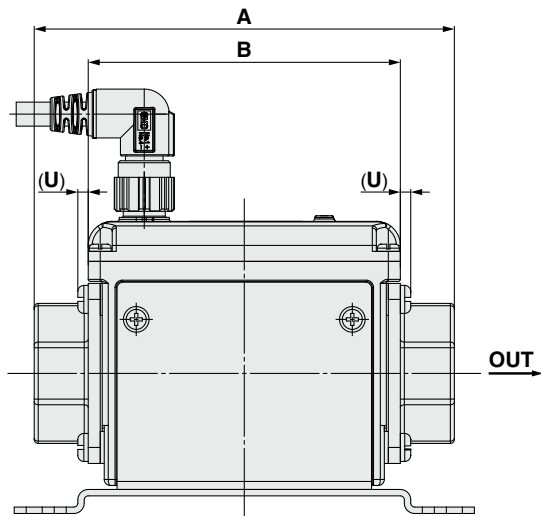
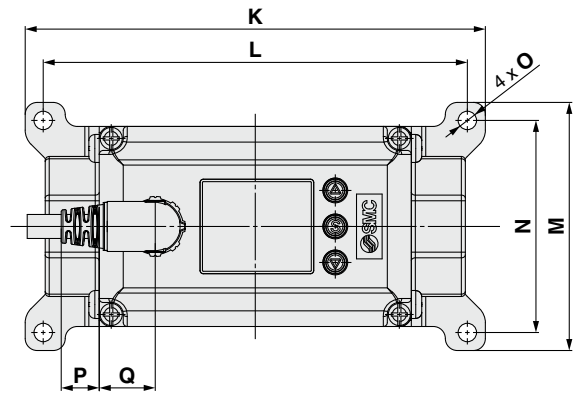

Bracket thickness is approx. 1.6 mm

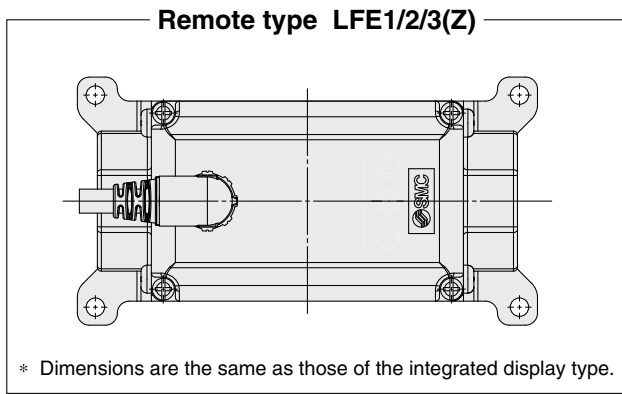

\* Dimensions are the same as those of the integrated display type.

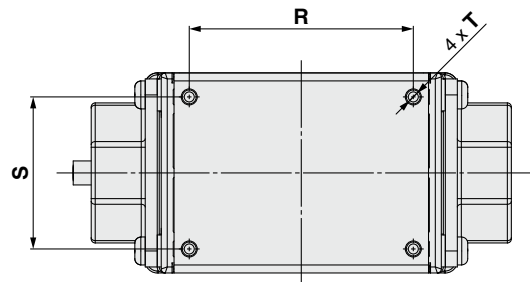

Without bracket (Bottom view)

Model	Port size	A	B	C	D	E	F	G	H	I	J	K	L	M	N	O	P	Q	R	S	T	U
LFE1□3□	3/8	90	73	40	23.5	56	83	89	24	6	1.6	96	87	48	39	4.6	12	11.5	52	28	ø2.5 depth 8.5	2
LFE1□4□	1/2	104	73	40	23.5	56	83	89	28	6	1.6	96	87	48	39	4.6	12	11.5	52	28	ø2.5 depth 8.5	2
LFE2□	3/4	105	78	50	29	67	94	100	35	6	1.6	115	106	62	53	4.6	9.5	14	56	38	ø2.5 depth 8.5	2.6
LFE3□	1	120	90	55	32	73	100	106	41	6	1.6	115	106	62	53	4.6	3.5	20	68	43	ø2.5 depth 8.5	2.6

\* If you are installing directly, choose a self-tapping screw with a screw-in depth of 8 mm. Tighten the screw with a torque of 0.7 to 0.8 N·m.

### Lead wire and M12 connector

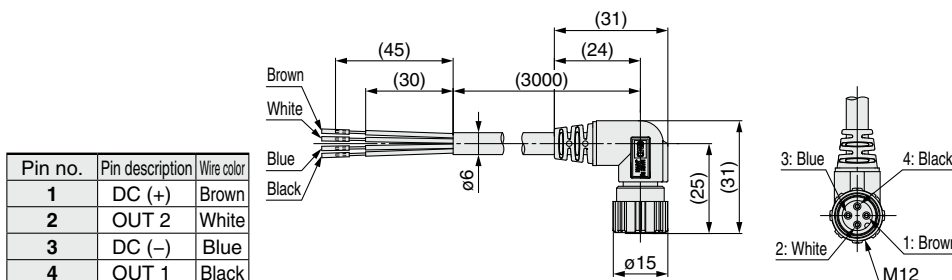

Pin no.	Pin description	Wire color
1	DC (+)	Brown
2	OUT 2	White
3	DC (-)	Blue
4	OUT 1	Black

### Cable Specifications

Conductor	Nominal cross section area	AWG21
	External diameter	Approx. 0.9 mm
Insulator	Material	Non-lead heat resistant PVC
	External diameter	Approx. 1.7 mm
Sheath	Colors	Brown, White, Black, Blue
	Material	Non-lead heat and oil resistant PVC
Finished external diameter		ø6

# 3-Color Display

# Digital Flow Monitor

# LFE0 Series



## How to Order

**LFE0 A - M V C**

### Type

**0** Remote type monitor

- \* When using the remote type, select LFE0J□□□□(Z) with an analog output of 1 to 5 V.
- \* Does not support the close proximity setting/zero-reset functions

### Output specifications

Symbol	OUT1	OUT2
<b>A</b>	NPN	NPN
<b>B</b>	PNP	PNP
<b>C</b>	NPN	Analog 1 to 5 V
<b>D</b>	NPN	Analog 4 to 20 mA

### Lead wire

<b>Nil</b>	With power supply/output connection lead wire (2 m)  Power supply/output connection lead wire ZS-40-W
<b>N</b>	Without power supply/output connection lead wire

The lead wire is shipped together with the product.

### Remote type monitor/Display unit

Symbol	Instantaneous flow rate	Accumulated flow
<b>M</b>	L/min	L
<b>G</b>	gal/min	gal

- \* Under the New Measurement Act, units other than SI (symbol "M") cannot be used in Japan.
- \* G: Made to order

Reference: 1 [L/min] ↔ 0.2642 [gal/min]  
1 [gal/min] ↔ 3.785 [L/min]

### Option 2

<b>Nil</b>	Without connector Sensor connector (1 pc.)
<b>C</b>	 Sensor connector (e-con)

The connector is shipped together with the product.

### Option 1

<b>Nil</b>	None
<b>T</b>	Panel mount adapter  Panel mount adapter Waterproof seal (Accessory) Panel Mounting screw (M3 x 8 L) (Accessory)
<b>V</b>	Front protective cover + Panel mount adapter Front protective cover  Panel mount adapter Waterproof seal (Accessory) Panel Mounting screw (M3 x 8 L) (Accessory)

## Options/Part Nos.

When only optional parts are required, order with the part numbers listed below.

Description	Part no.	Note
Panel mount adapter	<b>ZS-26-B</b>	With waterproof seal, mounting screw
Front protective cover + Panel mount adapter	<b>ZS-26-C</b>	With waterproof seal, mounting screw
Front protective cover only	<b>ZS-26-01</b>	Separately order panel mount adapter, etc.
Power supply/output connection lead wire	<b>ZS-40-W</b>	Lead wire length 2 m
Sensor connector (e-con)	<b>ZS-28-C-5</b>	1 pc.
Lead wire with connector for copying	<b>ZS-40-Y</b>	Connect up to 10 copy destination units



For flow switch precautions, refer to the Operation Manual on the SMC website.

## Specifications (Remote Type Monitor)

Model		LFE0		
Display flow range		0.4 to 24.0 L/min (Flow under 0.4 L/min is displayed as "0.0")	2.0 to 120.0 L/min (Flow under 2.0 L/min is displayed as "0.0")	4 to 240 L/min (Flow under 4 L/min is displayed as "0.0")
Set flow range		0.4 to 24.0 L/min	2.0 to 120.0 L/min	4 to 240 L/min
Smallest settable increment		0.1 L/min	0.5 L/min	1 L/min
Accumulated volume per pulse		0.1 L/pulse	0.5 L/pulse	1 L/pulse
Display units		Instantaneous flow rate L/min, Accumulated flow L		
Accuracy		Displayed values: $\pm 0.5\%$ F.S., Analog output: $\pm 0.5\%$ F.S.		
Repeatability		$\pm 0.5\%$ F.S.		
Temperature characteristics		$\pm 0.5\%$ F.S. (25°C reference)		
Accumulated flow range*1		99999999.9 L by 0.1 L	999999999 L by 1 L	
Switch output		NPN or PNP open collector output		
	Maximum load current	80 mA		
	Maximum applied voltage	28 VDC		
	Internal voltage drop	NPN: 1 V or less (at load current of 80 mA) PNP: 1.5 V or less (at load current of 80 mA)		
	Response time*2	Can be selected from 0.5 s, 1 s, 2 s, or 5 s		
	Output protection	Short-circuit protection		
	Output mode	Select from hysteresis mode, window comparator mode, accumulated output mode, or accumulated pulse output mode.		
	Flow rate Temperature	Select from hysteresis mode or window comparator mode.		
Response time*3		Linked with the switch output		
Analog output	Voltage output	Output voltage: 1 to 5 V Output impedance: 1 k $\Omega$		
	Current output	Output current: 4 to 20 mA Max. load impedance: 600 $\Omega$		
Hysteresis		Variable		
Input/output		Input for copy mode		
Display method		2-screen (Main screen: 4-digit, 7-segment, 2-color, Red/Green; Sub screen: 6-digit, 11-segment, White) Display values updated 5 times per second		
Status LED		Output 1, Output 2: Orange		
Power supply voltage		24 VDC $\pm 10\%$		
Current consumption		50 mA or less		
Connection		Power supply output 5P connector, sensor connection 4P connector (e-con)		
Environmental resistance	Enclosure	IP40 (Only front face of the panel is IP65 when optional panel mount adapter and waterproof seal are used.)		
	Operating temperature range	0 to 50°C (No freezing or condensation)		
	Operating humidity range	Operating, Storage: 35 to 85% R.H. (No condensation)		
	Withstand voltage	1000 VAC for 1 minute between terminals and housing		
	Insulation resistance	50 M $\Omega$ or more (500 VDC measured via megohmmeter) between terminals and housing		
Standards and regulations		CE/UKCA marking (EMC Directive, RoHS Directive)		
Weight	Without power supply/output connection lead wire	50 g		
	With power supply/output connection lead wire	100 g		

\*1 It is cleared when the power supply is turned OFF. A hold function can be selected. (Intervals of 2 or 5 minutes can be selected.) If 5-minute intervals are selected, the life of the memory element (electronic parts) is limited to 1 million times. (If energized for 24 hours, life is calculated as 5 minutes x 1 million = 5 million minutes = about 9.5 years.) Therefore, calculate the number of operations and use within the life.

\*2 The delay time until the set value reaches 63% in relation to the step input

\*3 The delay time until the set value reaches 63% in relation to the step input

## Analog Output

### Flow/Analog output

	A	B	C
Voltage output	1 V	1.1 V	5 V
Current output	4 mA	4.4 mA	20 mA

Connected sensor	Rated flow [L/min]	
	Minimum	Maximum
LFE1	0.5	20
LFE2	2.5	100
LFE3	5	200

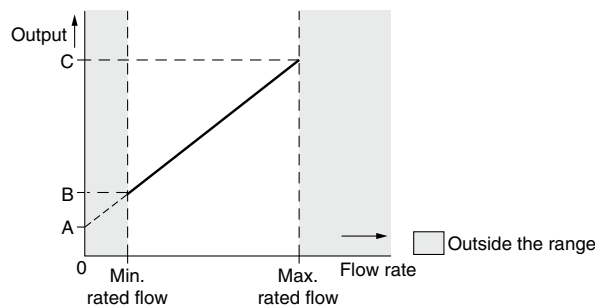

### Internal Circuits and Wiring Examples

#### NPN 2 output type LFE0A

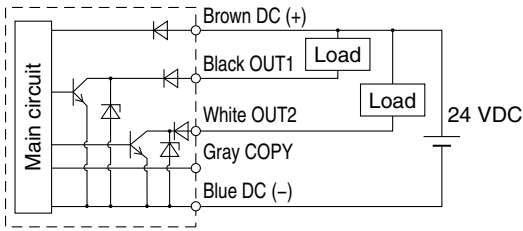

#### PNP 2 output type LFE0B

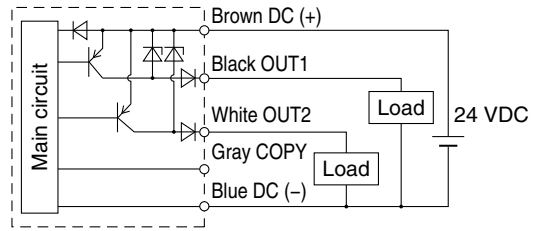

#### NPN + Analog output type LFE0C

#### NPN + Analog output type LFE0D

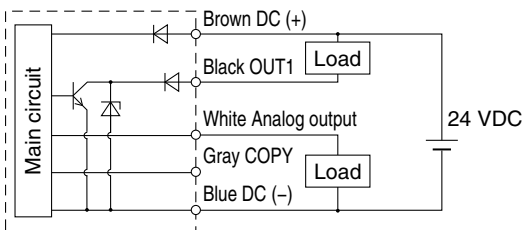

#### Sensor input circuit

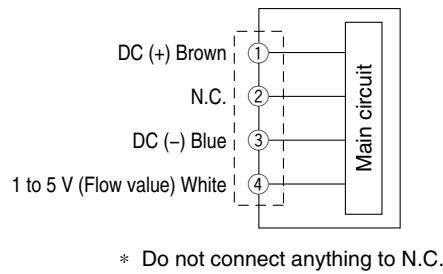

#### Connection example of LFE0C and LFE□J

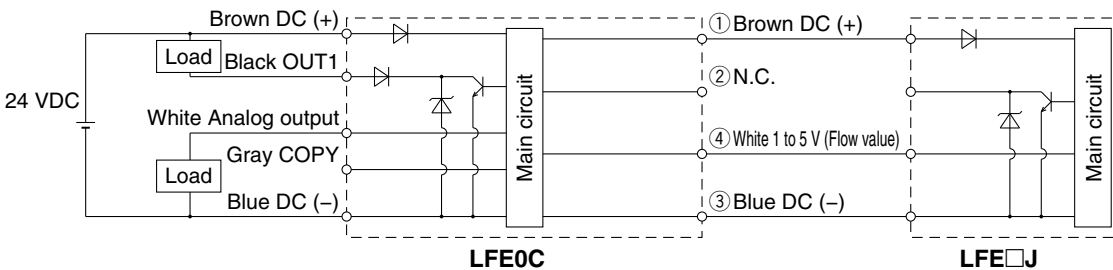

#### Accumulated pulse output wiring examples

#### NPN 2 output type LFE0A

#### NPN + Analog output type LFE0C/LFE0D

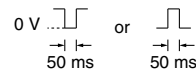
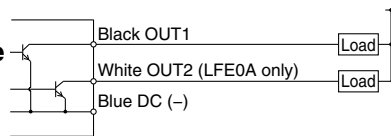

#### PNP 2 output type LFE0B

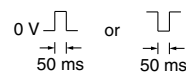
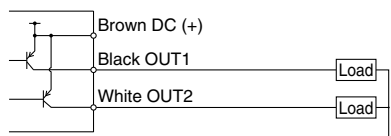

\* When accumulated pulse output is selected, the indicator light will be OFF.

# LFE0 Series

## Parts Description (Remote Type Monitor)

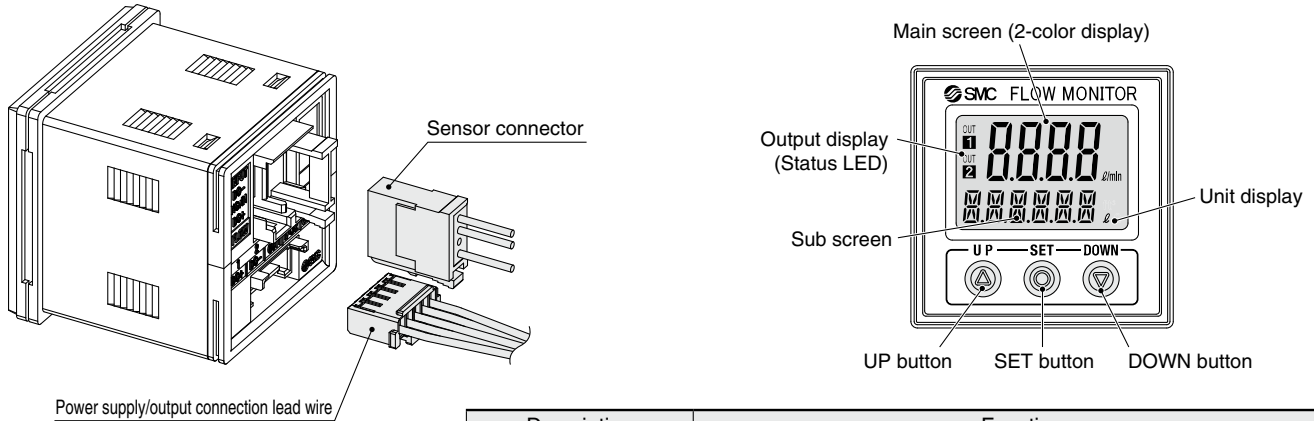

Description	Function
Main screen (2-color display)	Displays the flow value, setting mode, and error codes
Sub screen	Displays the accumulated flow, peak/bottom value, flow direction, and various setting values (For details, refer to page 17.)
Output display (Status LED)	Displays the output condition of OUT1 and OUT2. (When ON: Orange light turns on)
UP/DOWN button	Changes the selected items and increases or decreases the set value
SET button	Makes changes in each mode and enters the set value
Unit display	Indicates the unit currently selected

### Sensor connector

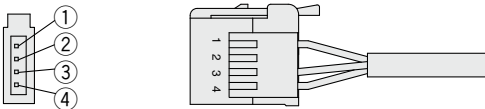

Pin no.	Terminal	Connector no.	Lead wire color *1
①	DC (+)	1	Brown
②	N.C./IN	2	Not used
③	DC (-)	3	Blue
④	INPUT	4	White (Flow sensor 1 to 5 V input)

\*1 When using the lead wire and M12 connector included with the LFE□J series  
Do not connect black.

### Power supply/output connection lead wire

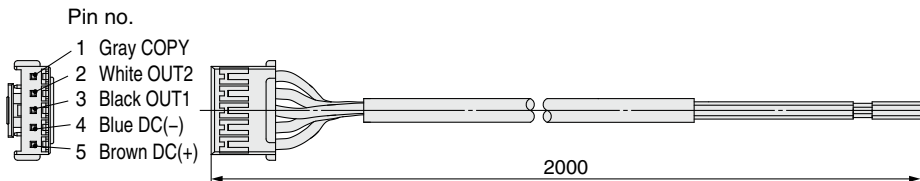

### Cable Specifications

Conductor	Nominal cross section area	AWG26
	External diameter	Approx. 0.5 mm
Insulator	Material	Cross-linked vinyl
	External diameter	Approx. 1.0 mm
Colors	Colors	Brown, Blue, Black, White, Gray
	Material	Oil and heat resistant vinyl
Finished external diameter		ø3.5

## Dimensions

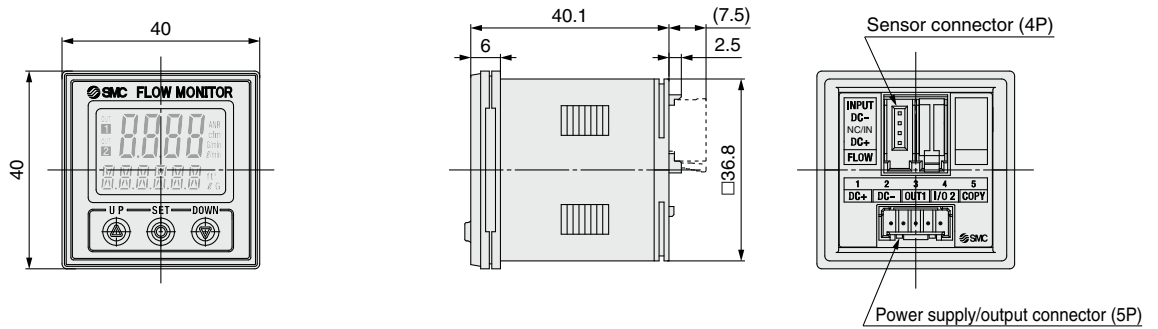

## Front protective cover + Panel mount adapter

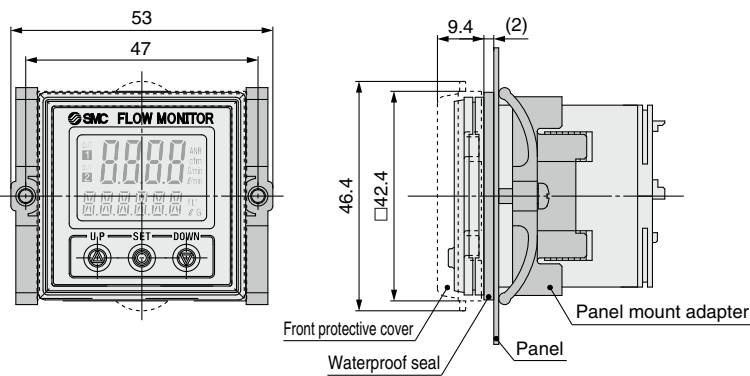

## Panel fitting dimensions

Applicable panel thickness:  
 0.5 to 8 mm (Without waterproof seal)  
 0.5 to 6 mm (With waterproof seal)

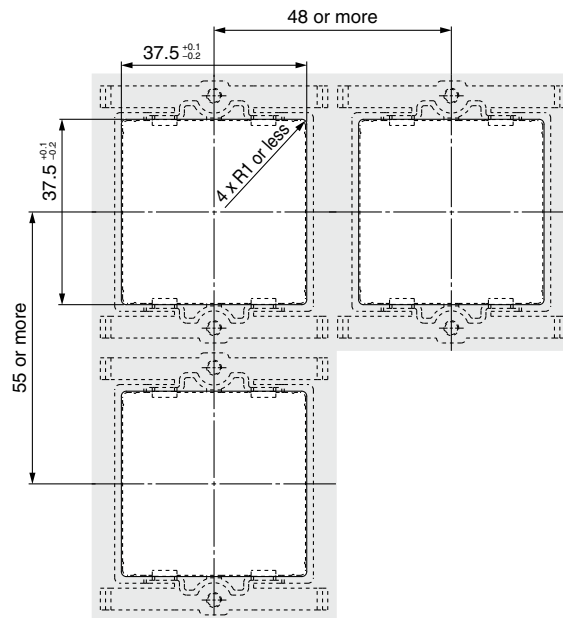

# LFE Series

## Function Details

### Output operation

The output operation can be selected from the following: Output (hysteresis mode and window comparator mode) corresponding to instantaneous flow or output (accumulated output and accumulated pulse output) corresponding to accumulated flow.

\* At the time of shipment from the factory, it is set to hysteresis mode.

### Display color

The display color can be selected for each output condition. The selection of the display color provides visual identification of abnormal values. (The display color depends on OUT1 settings.)

No.	Display
1	ON: Green, OFF: Red
2	ON: Red, OFF: Green
3	Normally: Red
4	Normally: Green

### Response time

The response time can be selected according to the application. (The default setting is 1 second.) The fluctuation of the displayed value can be reduced by setting a longer response time. If you need faster detection of problems such as leakage of tip cooling water for welding guns, switch output or analog output can be made faster by setting a shorter response time. In this case, widen the hysteresis to prevent the chattering of the switch output.

Response time	Stability
0.25 seconds	±3.7% F.S.
0.5 seconds	±2.5% F.S.
1 second	±1.7% F.S.
2 seconds	±1.2% F.S.
5 seconds	±0.8% F.S.

### Forced output

Forcing output to ON/OFF during system startup or maintenance can prevent system errors from occurring when checking the wiring and output.

For the analog output type, the output will be 5 V or 20 mA for ON and 1 V or 4 mA for OFF.

\* Forced output takes precedence regardless of the increase or decrease in flow rate.

### Accumulated value hold

The accumulated flow value can be retained even when the power supply is shut off. It can be stored at intervals of 2 or 5 minutes during measurement. The number of times the memory element can be accessed is 1 million times. Take this into consideration before use.

### Switching of flow direction (\* Integrated display type only)

The flow direction can be changed after installation.

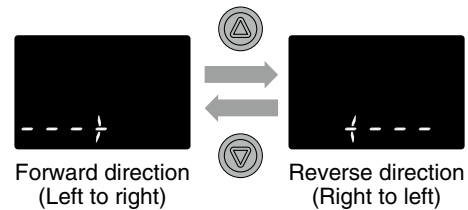

### Sub screen display

The display on the sub screen in measuring mode can be set.

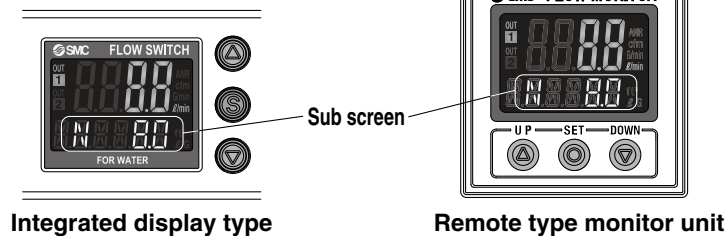

Set value display	Accumulated value display	Peak value display	Bottom value display
Displays the set value (The set value of OUT2 cannot be displayed.)	Displays the accumulated value (The accumulated value of OUT2 cannot be displayed.)	Displays the peak value	Displays the bottom value
Flow direction display (* Integrated display type only)	Line name display	Off	
Displays the flow direction (When the close proximity setting function is being used, the set value is also displayed.)	Displays the line name (Up to 6 alphanumeric characters can be input.)	Displays nothing	



## ■ Power-saving mode

The display can be turned off to reduce power consumption (by approx.10%). In power-saving mode, only decimal points blink. If any button is pressed during power-saving mode, the display is recovered for 30 seconds to check the flow, etc.

## ■ Keylock

The keylock function prevents operation errors such as accidentally changing setting values.

## ■ Peak/Bottom value display

The maximum (minimum) flow rate is detected and updated from when the power supply is turned on. In peak (bottom) value display mode, this maximum (minimum) flow rate is displayed.

## ■ Security code requests

During keylock release, you can request the input of a security code. By default, security code requests are disabled.

## ■ Error display

When an error or abnormality arises, the location and contents are displayed.

Display	Error name	Description	Action			
Er1	OUT1 over current error	A load current of 80 mA or more is applied to the switch output (OUT1).	Eliminate the cause of the over current by turning off the power supply and then turning it on again.			
Er2	OUT2 over current error	A load current of 80 mA or more is applied to the switch output (OUT2).				
Er3	Zero-reset error	The detection passage is not filled or the flow rate exceeds $\pm 20\%$ F.S. of the rated flow rate during zero-reset setting.	When there is no flow, and the detection passage is full, operate the unit.			
HHH	Instantaneous flow error	The flow rate has exceeded the display flow range.	Use the product within the rated range.			
LLL	Reverse flow error	Flow is flowing in the reverse direction of the setting.	Change the setting of the flow direction.			
9999999999 (Alternately displays [999] and [999999])	Accumulated flow error	The flow rate exceeds the accumulated flow rate range.	Clear the accumulated flow rate. (This error is irrelevant when accumulated flow is not being used.)			
Er0 Er4 Er6 Er8	System error	Internal data error	Shut off the power and then on again.			
Er10				Power supply voltage error	The power supply voltage exceeds $24\text{ V} \pm 10\%$ .	Adjust the power supply voltage and then turn the power on again.

If the error cannot be solved after the above instructions are performed, please contact SMC for investigation.

## ■ Analog output free range

This is available for all analog output compatible products. The max. value of analog output can be any flow rate value within the rated range.

■ **Close proximity setting** (\* Integrated display type only) — By activating the close proximity setting function, flickering of the display in the uninstalleable area can be reduced.

In cases where “Flow direction display” is displayed on the sub screen, the close proximity setting function can be activated by pressing the  $\odot$  and  $\ominus$  buttons simultaneously for at least one second.

### Forward direction flow

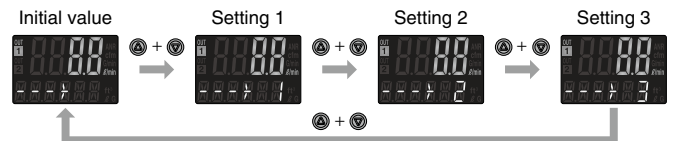

## ■ Zero-reset (\* Integrated display type only)

Enables the display to be adjusted to zero

# LFE Series

# Made to Order

Please consult with SMC for detailed specifications, delivery times, and prices.



## 1 Piping connection ports: Stainless steel 304

Symbol  
**-X8**

### Specifications

Model		LFE1-X8		LFE2-X8		LFE3-X8	
Fluid contact materials		PPS, FKM, Stainless steel 304					
Port size		3/8 (10A)	1/2 (15A)	3/4 (20A)		1 (25A)	
Weight (Body)*1	Integrated display type (Isolated type/Non-isolated type)	Approx. 380 g	Approx. 430 g	Approx. 620 g		Approx. 800 g	
	Remote type (Isolated type/Non-isolated type)	Approx. 375 g	Approx. 425 g	Approx. 615 g		Approx. 795 g	

\*1 When options are used, add the weight of the optional parts.

Other specifications not listed (excluding the NPT thread type) are the same as those of the standard model.

### Fluid Passage Structure

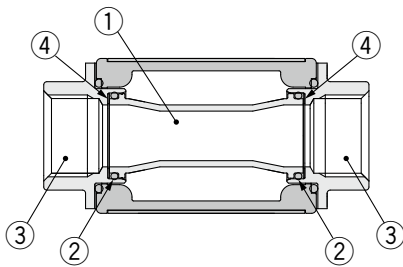

No.	Description	Material
1	Pipe	PPS
2	O-ring	FKM
3	Attachment	Stainless steel 304
4	Spacer	FKM

### Dimensions

#### Integrated display type LFE1/2/3(Z)-X8

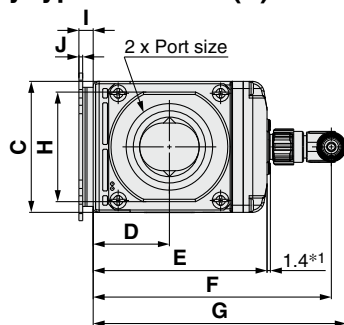

\*1 For the integrated display type

\* The electrical entry for the lead wire and M12 connector does not rotate and is limited to only one entry direction.

#### Remote type LFE1/2/3(Z)-X8

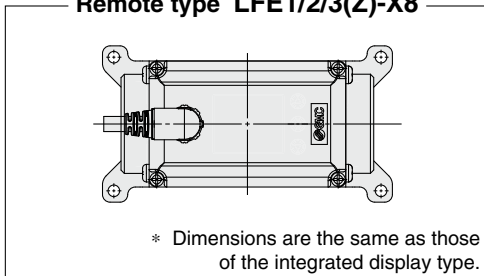

\* Dimensions are the same as those of the integrated display type.

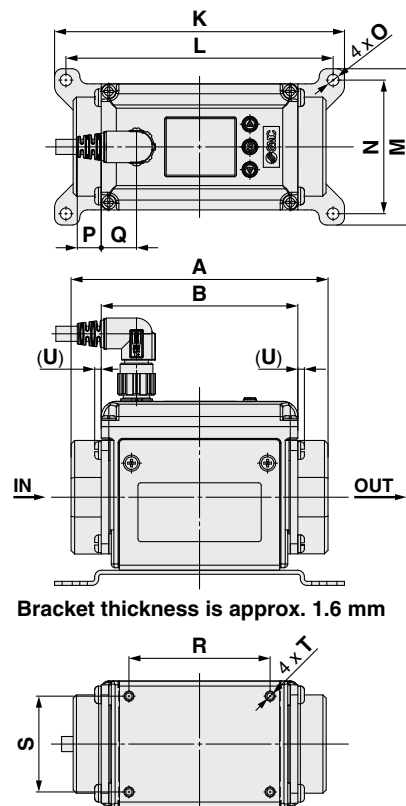

Bracket thickness is approx. 1.6 mm

Without bracket (Bottom view)

Model	Port size	A	B	C	D	E	F	G	H	I	J	K	L	M	N	O	P	Q	R	S	T	U
LFE1□3□	3/8	90	73	40	23.5	56	83	89	30	6	1.6	96	87	48	39	4.6	12	11.5	52	28	ø2.5 depth 8.5	2
LFE1□4□	1/2	104	73	40	23.5	56	83	89	30	6	1.6	96	87	48	39	4.6	12	11.5	52	28	ø2.5 depth 8.5	2
LFE2□	3/4	105	78	50	29	67	94	100	41	6	1.6	115	106	62	53	4.6	9.5	14	56	38	ø2.5 depth 8.5	2.6
LFE3□	1	120	90	55	32	73	100	106	46	6	1.6	115	106	62	53	4.6	3.5	20	68	43	ø2.5 depth 8.5	2.6

\* If you are installing directly, choose a self-tapping screw with a screw-in depth of 8 mm. Tighten the screw with a torque of 0.7 to 0.8 N-m.



# LFE Series Specific Product Precautions 1

Be sure to read this before handling the products. Refer to the back cover for safety instructions. For flow switch precautions, refer to the “Handling Precautions for SMC Products” and the “Operation Manual” on the SMC website: <https://www.smcworld.com>

## Installation

### Warning

#### 1. Be sure to confirm the applicable fluids.

The product does not have an explosion proof construction. To prevent any possible fire hazards, do not use with inflammable gases or fluids.

#### 2. Install the system so that the fluid always fills the detection passage.

If the product is used when the detection passage is not filled or when it is in a condition such that air bubbles are liable to be emitted, the correct detection signal will fail to be output from the electrodes, making correct measurement impossible. Install the system so that fluid remains in the detection passage even when the fluid flow is stopped. For vertical mounting, introduce the fluid from the bottom because bubbles may be generated when fluid is introduced from the top, which may lead to operation failure.

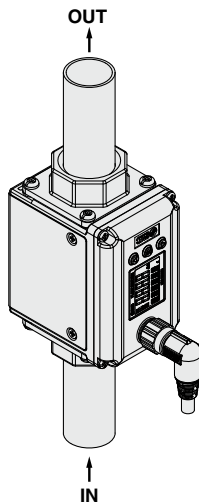

When the product is mounted horizontally, place the display vertical to the floor to prevent bubbles from occurring.

Mounting orientation: ○

Mounting orientation: ×

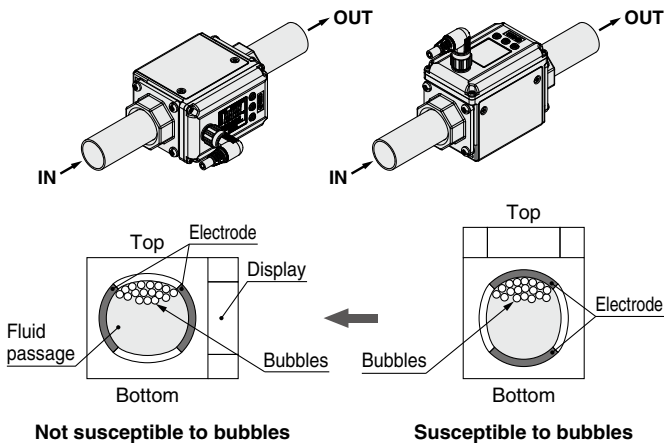

## Mounting

### Warning

#### 1. The non-isolated type piping port is connected with the negative ground of the power supply. The positive ground of the power supply and the ground of the piping port cannot be connected because they may cause the power supply to short-circuit. For positive ground, use the isolated type (LFE□Z) that is separated from the power supply.

#### 2. Avoid using piping which changes size suddenly on the IN side (fluid inlet side).

If the piping size is reduced sharply or there is a restrictor such as a valve on the IN side, fluid velocity distribution in the piping will be disturbed, leading to improper measurement.

If the OUT side is opened or the flow rate is excessive, cavitations may be generated, which may result in improper measurement. As a countermeasure, cavitation can be reduced by increasing fluid pressure by mounting a restrictor on the OUT side. If the restrictor on the OUT side is fully closed when operating the pump, the product may malfunction due to the effects of pulsation (pressure fluctuation). Ensure that there is no malfunction before usage.

#### 3. When multiple units are to be used in parallel, secure a distance between the units as shown in the figure below. The detection flow rate may fluctuate if multiple units are installed in parallel inside the uninstallable area.

#### Uninstallable area

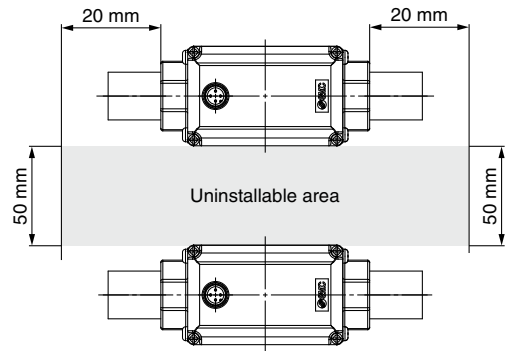

#### Integrated display type

In cases where multiple units are to be installed in parallel inside the uninstallable area, fluctuation of the detection flow rate can be reduced by using the close proximity setting function.

#### Example of close proximity setting (\* Integrated display type only)

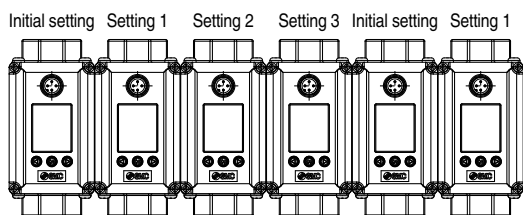

#### 4. Use caution so that the electrical entry for the lead wire and M12 connector does not rotate and is limited to only one direction.



# LFE Series

## Specific Product Precautions 2

Be sure to read this before handling the products. Refer to the back cover for safety instructions. For flow switch precautions, refer to the “Handling Precautions for SMC Products” and the “Operation Manual” on the SMC website: <https://www.smcworld.com>

### Mounting

#### ⚠ Caution

- When turning piping, apply a tool to the attachment part of the piping (metal part of body) and turn the piping or fitting so that stress is not applied.

Using a wrench on other parts may damage the product. Specifically, make sure that the wrench does not damage the M12 connector. This will damage the connector.

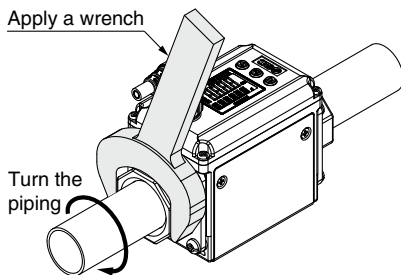

#### Width across flats of attachment

Port size	Width across flats
3/8	24 mm
1/2	28 mm
3/4	35 mm
1	41 mm

Refer to the tightening torque in the table on the right for connecting steel piping. Using a torque lower than the value in the table may result in fluid leakage. For mounting fittings, refer to the torque specified for each.

Nominal thread size	Proper tightening torque [N·m]
Rc (NPT) 3/8	22 to 24
Rc (NPT) 1/2	28 to 30
Rc (NPT) 3/4	28 to 30
Rc (NPT) 1	36 to 38

- The product body is made of resin. Do not apply stress, vibration, or impact directly on the product during piping work. Doing so may result in failure, damage, and water leakage.

In particular, never mount a product in a location that will be used as a foothold.

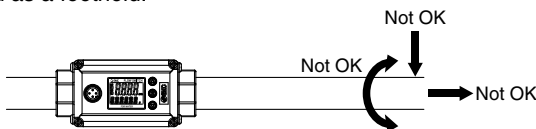

- Secure the pipes as close to the product as possible in order to prevent stress, vibration, and impact from being applied directly on the product.

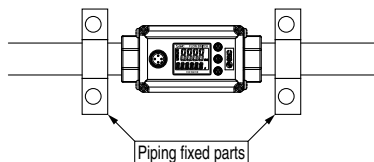

- If stress, vibration, and impact cannot be reduced, secure each pipe in multiple locations.

- Inflexible piping such as steel piping tends to be affected by the spread of excessive moment load or vibration. Lay flexible tubing between the steel pipe and the product to prevent such adverse effects.

In particular, if the piping is off-center with the product, load will be applied on the piping for a long period even after the piping work, possibly resulting in failure, damage, or water leakage.

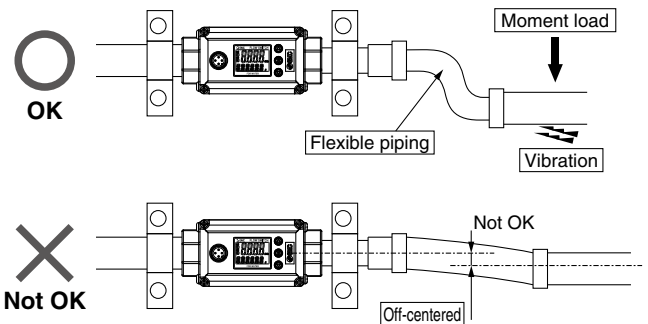

- When using a One-touch fitting, hold the fitting by hand to prevent the load required for connecting or disconnecting the tube from being applied directly on the product.

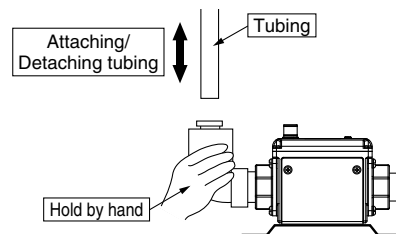

- The straight piping length on the IN side should be 5 times (5D) or more the piping size to achieve stable measurement. (Refer to page 8.)

- The operating pressure range varies depending on the fluid temperature. The fluid pressure and temperature should fall within their respective allowable ranges during operation. (Refer to page 8.)



# LFE Series

## Specific Product Precautions 3

Be sure to read this before handling the products. Refer to the back cover for safety instructions. For flow switch precautions, refer to the “Handling Precautions for SMC Products” and the “Operation Manual” on the SMC website: <https://www.smcworld.com>

### Operating Precautions

#### Warning

1. The body will reach high temperatures when used with high temperature fluids. Use caution, as there is a danger of being burned if the body comes into direct contact with the product.
2. The enclosure rating is for products with a lead wire and M12 connector. Be careful when handling products without a connector.

### Operating Environment

#### Warning

1. **Never use in the presence of explosive gases.**  
The product does not have an explosion proof construction. If it is used in an environment where explosive gases are present, it may cause an explosion. Therefore, never use it in such an environment.
2. **Stay within the specified fluid temperature range and ambient temperature range.**  
The operating fluid temperature range is 0 to 85°C, and the ambient temperature range is 0 to 50°C. Take measures to prevent moisture from freezing in piping circuits when using at 5°C or less, since this may cause damage to the product and lead to malfunction. Even when the ambient temperature range is within the specifications, do not use in locations where there are rapid temperature changes.
3. **If the temperature of the fluid is lower than the ambient temperature, condensation will be generated which may damage the product or cause malfunction.**

### Maintenance

#### Warning

1. **Take precautions when using the product for an interlock circuit.**  
When the product is used for an interlock circuit, devise a multiple interlock system to prevent problems or malfunction, and check the operation of the product and interlock function on a regular basis.

### Fluid

#### Warning

1. **Check regulators and flow adjustment valves before introducing the fluid.**  
If pressure or a flow rate beyond the specified range are applied, the internal detection passage may be damaged.

### Fluid

#### Caution

1. **Use fluids with electric conductivity of 5 μS/cm or more.**  
Note that this product cannot be used for fluids with low conductivity. This product cannot be used for fluids that do not conduct electricity such as deionized water (pure water) and oil.

#### Applicable Fluids List

Substance description	Judgement	Note
Water	○	Electric conductivity of tap water: 100 to 200 μS/cm
Deionized water (pure water)	×	Electric conductivity is too low.
Water-soluble coolant	○	When the ratio of water is 50% or more
Oil	×	Electric conductivity is too low.
Oil-based coolant	×	Electric conductivity is too low.
Sea water	×	Corrosive to the product
Ethylene glycol	×	Electric conductivity is too low.
Ethanol	×	Electric conductivity is too low.
Methanol	×	Electric conductivity is too low.
Chloride water (Hypochlorous acid)	×	Corrosive to the product

\* The table is for reference only. ○: Acceptable ×: Not acceptable

Conductivity is an indicator of ease of electrical flow.

2. **If insulating material gets stuck inside of the detection passage, it may cause an error.**  
Remove the foreign material stuck inside of the piping with a brush for washing test tubes so that the inside will not be damaged.
3. **If a conductive material such as metal coats the entire surface of the detection passage, the product may malfunction.**  
Remove the foreign material as mentioned above.
4. **If fluid with a stray current flowing inside is measured, the product may malfunction.**  
Be aware that earth leakage from equipment around the product, such as pumps, and stray currents caused by ground faults should not flow into the fluid to be measured.
5. **Any fluid which corrodes the internal fluid contact parts cannot be used.**





# LFE Series

## Specific Product Precautions 4

Be sure to read this before handling the products. Refer to the back cover for safety instructions. For flow switch precautions, refer to the “Handling Precautions for SMC Products” and the “Operation Manual” on the SMC website: <https://www.smcworld.com>

### Others

#### Warning

1. After the power is turned ON, the output remains OFF while a message is displayed (approx. 3 s). Start the measurement after a value is displayed.
2. Perform setting after stopping control systems.
3. Keep the product away from strong magnets and magnetic fields to prevent the product from malfunctioning.

### Set Flow Range and Rated Flow Range

#### Caution



Set the flow rate within the rated flow range.

The set flow range is the range of flow rate within which setting is possible.

The rated flow range is the range within which the product specifications (accuracy, repeatability, etc.) are satisfied.

Even if the rated flow range is exceeded, measurements can be made within the set flow rate range, but the specifications cannot be guaranteed.

Model	Flow range							
	0.5 L/min	2 L/min	5 L/min	10 L/min	20 L/min	50 L/min	100 L/min	200 L/min
LFE1	0.5 L/min				20 L/min			
	0.4 L/min				24 L/min			
	0.4 L/min				24 L/min			
LFE2		2.5 L/min					100 L/min	
		2 L/min					120 L/min	
		2 L/min					120 L/min	
LFE3			5 L/min					200 L/min
			4 L/min					240 L/min
			4 L/min					240 L/min

 Rated flow range  
 Display flow range  
 Set flow range

## Safety Instructions

These safety instructions are intended to prevent hazardous situations and/or equipment damage. These instructions indicate the level of potential hazard with the labels of “**Caution**,” “**Warning**” or “**Danger**.” They are all important notes for safety and must be followed in addition to International Standards (ISO/IEC)\*1), and other safety regulations.

 **Caution:** **Caution** indicates a hazard with a low level of risk which, if not avoided, could result in minor or moderate injury.

 **Warning:** **Warning** indicates a hazard with a medium level of risk which, if not avoided, could result in death or serious injury.

 **Danger :** **Danger** indicates a hazard with a high level of risk which, if not avoided, will result in death or serious injury.

\*1) ISO 4414: Pneumatic fluid power – General rules relating to systems.  
ISO 4413: Hydraulic fluid power – General rules relating to systems.  
IEC 60204-1: Safety of machinery – Electrical equipment of machines.  
(Part 1: General requirements)  
ISO 10218-1: Manipulating industrial robots – Safety.  
etc.

### Warning

#### 1. The compatibility of the product is the responsibility of the person who designs the equipment or decides its specifications.

Since the product specified here is used under various operating conditions, its compatibility with specific equipment must be decided by the person who designs the equipment or decides its specifications based on necessary analysis and test results. The expected performance and safety assurance of the equipment will be the responsibility of the person who has determined its compatibility with the product. This person should also continuously review all specifications of the product referring to its latest catalog information, with a view to giving due consideration to any possibility of equipment failure when configuring the equipment.

#### 2. Only personnel with appropriate training should operate machinery and equipment.

The product specified here may become unsafe if handled incorrectly. The assembly, operation and maintenance of machines or equipment including our products must be performed by an operator who is appropriately trained and experienced.

#### 3. Do not service or attempt to remove product and machinery/equipment until safety is confirmed.

1. The inspection and maintenance of machinery/equipment should only be performed after measures to prevent falling or runaway of the driven objects have been confirmed.
2. When the product is to be removed, confirm that the safety measures as mentioned above are implemented and the power from any appropriate source is cut, and read and understand the specific product precautions of all relevant products carefully.
3. Before machinery/equipment is restarted, take measures to prevent unexpected operation and malfunction.

#### 4. Contact SMC beforehand and take special consideration of safety measures if the product is to be used in any of the following conditions.

1. Conditions and environments outside of the given specifications, or use outdoors or in a place exposed to direct sunlight.
2. Installation on equipment in conjunction with atomic energy, railways, air navigation, space, shipping, vehicles, military, medical treatment, combustion and recreation, or equipment in contact with food and beverages, emergency stop circuits, clutch and brake circuits in press applications, safety equipment or other applications unsuitable for the standard specifications described in the product catalog.
3. An application which could have negative effects on people, property, or animals requiring special safety analysis.
4. Use in an interlock circuit, which requires the provision of double interlock for possible failure by using a mechanical protective function, and periodical checks to confirm proper operation.

### Caution

#### 1. The product is provided for use in manufacturing industries.

The product herein described is basically provided for peaceful use in manufacturing industries.  
If considering using the product in other industries, consult SMC beforehand and exchange specifications or a contract if necessary.  
If anything is unclear, contact your nearest sales branch.

### Limited warranty and Disclaimer/ Compliance Requirements

The product used is subject to the following “Limited warranty and Disclaimer” and “Compliance Requirements”.

Read and accept them before using the product.

#### Limited warranty and Disclaimer

1. The warranty period of the product is 1 year in service or 1.5 years after the product is delivered, whichever is first.\*2)  
Also, the product may have specified durability, running distance or replacement parts. Please consult your nearest sales branch.
2. For any failure or damage reported within the warranty period which is clearly our responsibility, a replacement product or necessary parts will be provided.  
This limited warranty applies only to our product independently, and not to any other damage incurred due to the failure of the product.
3. Prior to using SMC products, please read and understand the warranty terms and disclaimers noted in the specified catalog for the particular products.

##### \*2) Vacuum pads are excluded from this 1 year warranty.

A vacuum pad is a consumable part, so it is warranted for a year after it is delivered.  
Also, even within the warranty period, the wear of a product due to the use of the vacuum pad or failure due to the deterioration of rubber material are not covered by the limited warranty.

#### Compliance Requirements

1. The use of SMC products with production equipment for the manufacture of weapons of mass destruction (WMD) or any other weapon is strictly prohibited.
2. The exports of SMC products or technology from one country to another are governed by the relevant security laws and regulations of the countries involved in the transaction. Prior to the shipment of a SMC product to another country, assure that all local rules governing that export are known and followed.

### Caution

#### SMC products are not intended for use as instruments for legal metrology.

Measurement instruments that SMC manufactures or sells have not been qualified by type approval tests relevant to the metrology (measurement) laws of each country. Therefore, SMC products cannot be used for business or certification ordained by the metrology (measurement) laws of each country.

#### Revision History

<b>Edition B</b>	* The length of the bracket mounting hole has been changed. * Cautions on installation and mounting have been added to the specific product precautions.	SZ
<b>Edition C</b>	* Stainless steel 304 has been added to the piping connection ports material. * Functions (close proximity setting and zero-reset setting) have been added. WR	
<b>Edition D</b>	* An isolated type has been added. * Number of pages has been increased from 24 to 28.	YX

## Safety Instructions

Be sure to read the “Handling Precautions for SMC Products” (M-E03-3) and “Operation Manual” before use.