

Electric Actuator

High Performance

High Rigidity Guide Rod Type

Battery-less Absolute (Step Motor 24 VDC)

Size: 25, 32, 40

New



For details, refer to page 43 and onward.

RoHS

Max. weight of transferred object

Size 25

Size 32

Size 40

75 kg 100 kg 150 kg

Application example

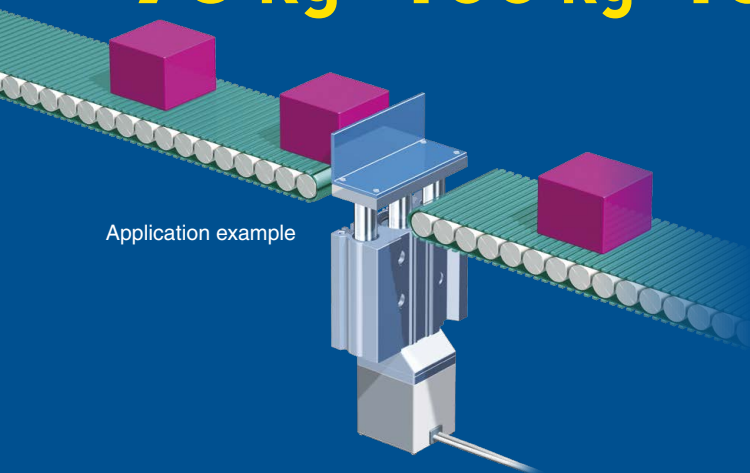

High performance step motor controller

Max. acceleration/deceleration: 5000 mm/s²

With internal battery-less absolute encoder

- Restart from the last stop position is possible after recovery of the power supply.
- Reduced maintenance (No need for control or replacement)

Auto switches are mountable. (In-line only)

For checking the limit and the intermediate signal

D-M9□/D-P3DWA

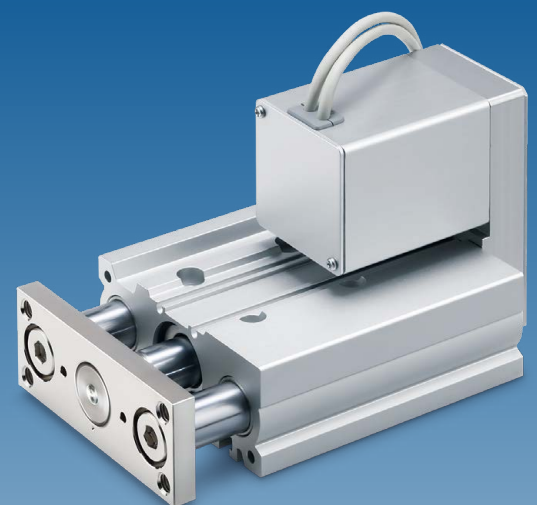

LEG Series



CAT.ES100-143A

Fully integrated the compact guide unit for improved lateral load capacity

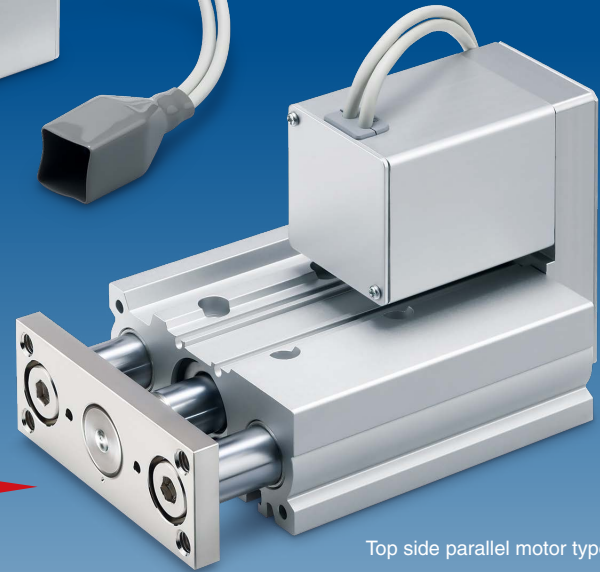
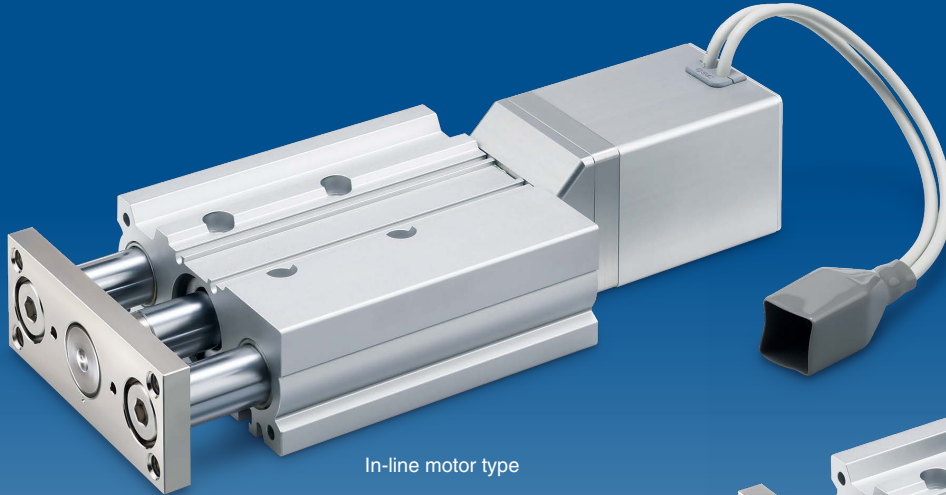

Improved rigidity
Lateral end load:
5 times more^{*1}

^{*1} Compared with the rod type, size 25, and 100 mm stroke

Variations

Motor type	Size	Max. weight of transferred object [kg]	Work load [kg]		Positioning repeatability [mm]	Stroke [mm]
			Horizontal	Vertical		
 Battery-less absolute (Step motor 24 VDC)	25	75	20	24	±0.02	30 50 100
	32	100	45	27		
	40	150	60	27		

High Performance Step Motor Controller

Higher acceleration and max. speed can be set with the special controller.

Parallel I/O
JXC5H/6H Series [p. 29](#)



EtherCAT/EtherNet/IP™/
 PROFINET

JXCEH/9H/PH Series [p. 36](#)



Width **110 mm** x Height **113.5 mm** x Overall length **185 mm**

Size 25, 50 mm stroke



Small auto switches can be directly mounted on 2 surfaces.

For checking the limit and the intermediate signal

* Motor mounting position: In-line only

Solid state auto switch
D-M9□



Magnetic field-resistant 2-color indicator
solid state auto switch
D-P3DWA

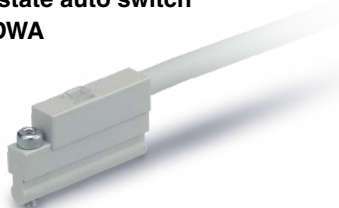



ACT 2 Controller Setting Software ACT Controller 2

Easy-to-use setting software ACT Controller 2 (For PC)

Various functions available in normal mode (Compared with the existing ACT Controller)

● Parameter and step data setting

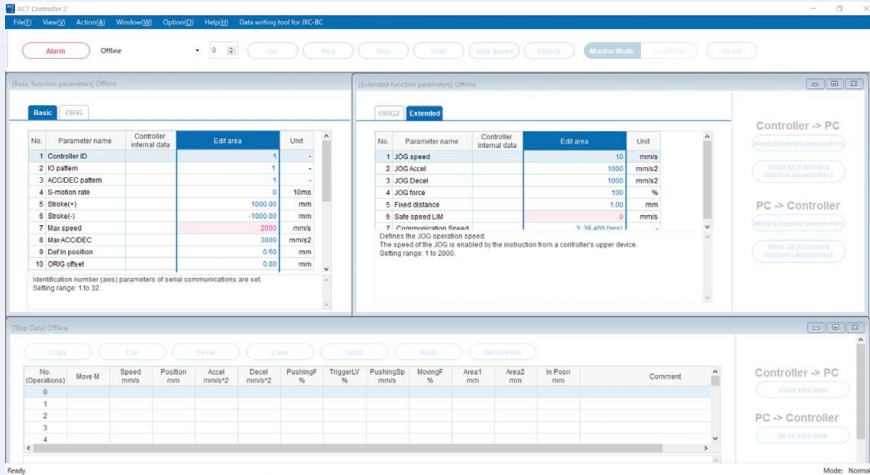

* Customers operating computers with specifications other than Windows 10/64 bit and Windows 11 should use the existing ACT Controller.

● Alarm confirmation

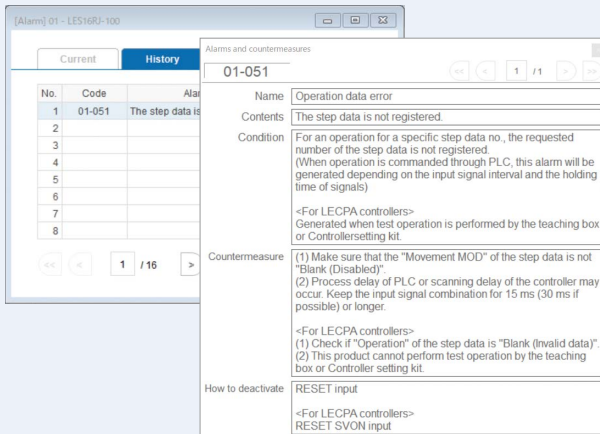

When an alarm is generated, the alarm details and countermeasures can be confirmed.

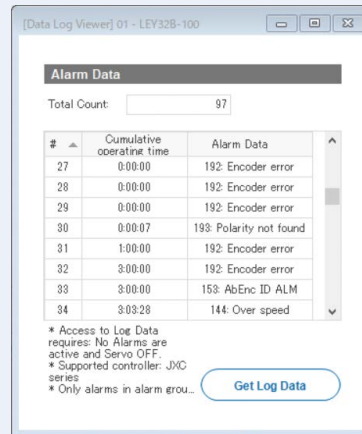

When an alarm is generated, the cumulative start-up time of the controller can be confirmed.

● Waveform monitoring

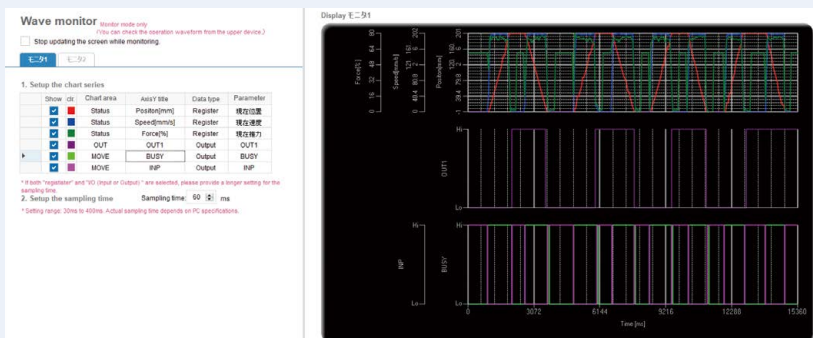

The position, speed, force, and input/output signals' waveform data during operation can be measured.

* When using the ACT Controller 2 test operation function, waveform monitoring is not available.

Step Data Input Type JXC5H/6H Series **p. 28**



ACT 2

Controller Setting Software ACT Controller 2

• The JXC-BC writing tool

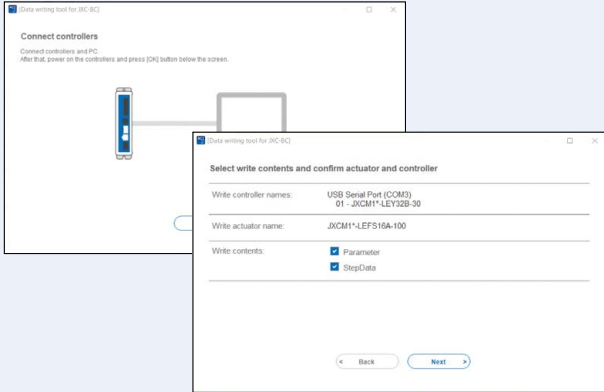

The writing tool can be used to write the connected actuator's parameters and step data to a JXC series blank controller.

• Customizable plug-in functions

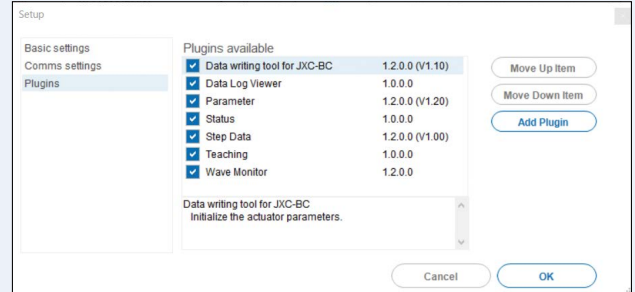

Which plug-in functions are displayed as well as the display order are customizable. Customers can add the functions they require.

In normal mode, various other test operation methods (program operation, jogging, moving of the constant rate, etc.), signal status monitoring, one-touch switching between Japanese and English, and other functions are available.

For immediate use, operate in easy mode.

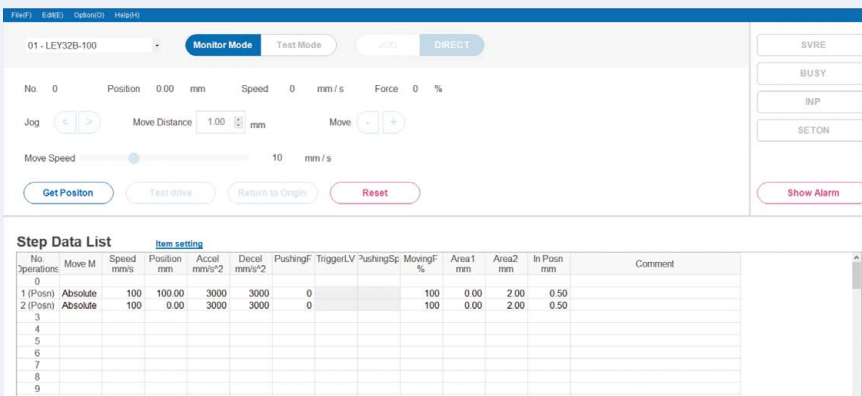

Step data setting, various test operations, and status confirmation can be done on a single screen.

How to download the setting software

[Click here for details.](#)

Operation Manuals

Product Search Search Enter product name, series, model.

Series Search **A B C D E F G H I J K L M N O P Q R S T U V W X Y Z** Please select a series.

Setting tool (Setting Software)

Product name	Series/Model	Download	Replacement Procedure	Note
Controller setting software, (For 3-axis Step Motor Controller) Installation Manual	JXC-MA1	English		
Controller setting software, (For 3-axis Step Motor Controller) Installation Manual	JXC-MA1	English		
Controller Setting Software (For 4-axis Step Motor Controller)	JXC-W1	English, Chinese		
Controller Setting Software (For 4-axis Step Motor Controller)	JXC-W1	English		
Controller setting software, (JXC□□□□JXC□□□□LECA6,LECPA) *This is a setting software with newer features than the previous ACT Controller. Note: Operating environment: Windows® 10 (64-bit).	ACT Controller 2	English		Software download.
ACT Controller	ACT Controller			

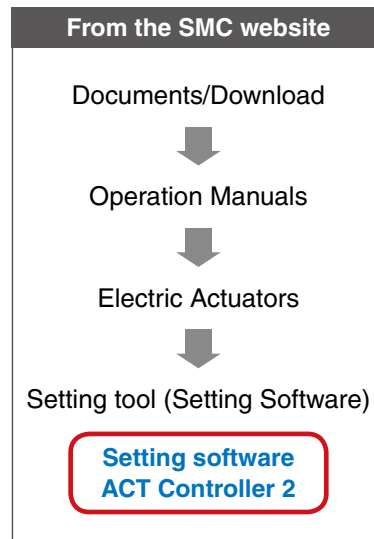

Step Data Input Type JXC5H/6H Series p. 29



Teaching Box

Normal Mode

- Multiple step data can be stored in the teaching box and transferred to the controller.
- Continuous test drive by up to 5 step data

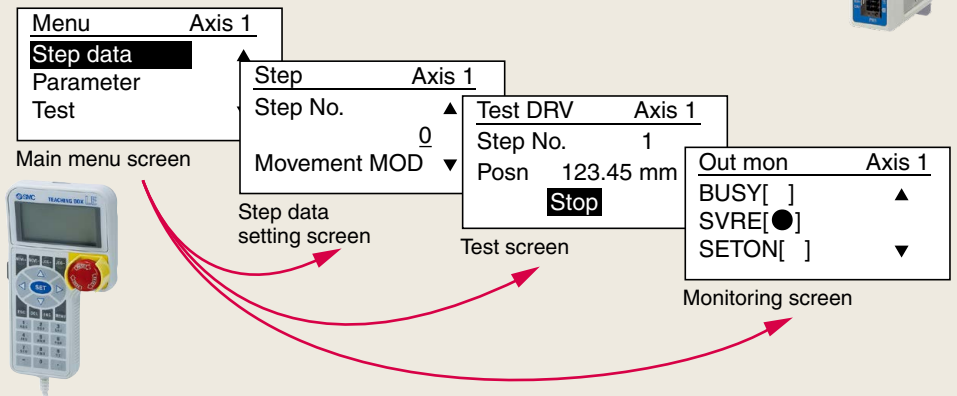

Teaching box screen

- Each function (step data setting, test drive, monitoring, etc.) can be selected from the main menu.

Easy Mode

- The simple screen without scrolling promotes ease of setting and operation.
- Choose an icon from the first screen to select a function.
- Set the step data and check the monitor on the second screen.



Example of setting the step data

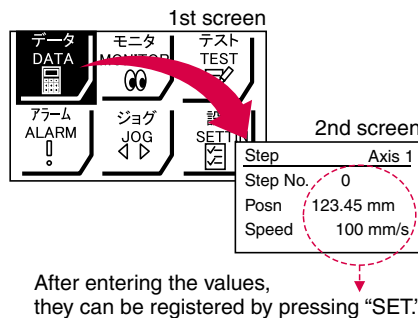

Example of checking the operation status

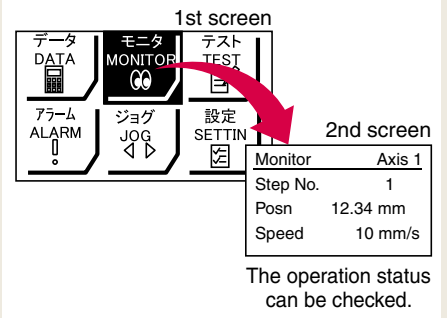

Teaching box screen

- Data can be set by inputting only the position and speed. (Other conditions are preset.)

Step	Axis 1
Step No.	0
Posn	50.00 mm
Speed	200 mm/s



Step	Axis 1
Step No.	1
Posn	80.00 mm
Speed	100 mm/s

The actuator and controller are provided as a set. (They can be ordered separately as well.)

Confirm that the combination of the controller and actuator is correct.

<Check the following before use.>

- ① Check the actuator label for the model number. This number should match that of the controller.
- ② Check that the Parallel I/O configuration matches (NPN or PNP).

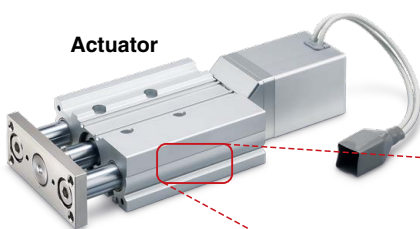

Controller



Function

Item	Step data input type JXC5H/6H
Step data and parameter setting	<ul style="list-style-type: none"> Input from controller setting software (PC) Input from teaching box
Step data “position” setting	<ul style="list-style-type: none"> Numerical value input from controller setting software (PC) or teaching box Input numerical value Direct teaching JOG teaching
Number of step data	64 points
Operation command (I/O signal)	Step No. [IN ⁺] input ⇒ [DRIVE] input
Completion signal	[INP] output

Setting Items

TB: Teaching box PC: Controller setting software

Item		Contents	Easy Mode		Normal Mode	Step data input type JXC5H/6H
			TB	PC	TB/PC	
Step data setting (Excerpt)	Movement MOD	Selection of “absolute position” and “relative position”	△	●	●	Set at ABS/INC
	Speed	Transfer speed	●	●	●	Set in units of 1 mm/s
	Position	[Position]: Target position [Pushing]: Pushing start position	●	●	●	Set in units of 0.01 mm
	Acceleration/Deceleration	Acceleration/deceleration during movement	●	●	●	Set in units of 1 mm/s ²
	Pushing force	Rate of force during pushing operation	●	●	●	Set in units of 1%
	Trigger LV	Target force during pushing operation	△	●	●	Set in units of 1%
	Pushing speed	Speed during pushing operation	△	●	●	Set in units of 1 mm/s
	Moving force	Force during positioning operation	△	●	●	Set to 100%
	Area output	Conditions for area output signal to turn ON	△	●	●	Set in units of 0.01 mm
	In position	[Position]: Width to the target position [Pushing]: How much it moves during pushing	△	●	●	Set to 0.5 mm or more (Units: 0.01 mm)
Parameter setting (Excerpt)	Stroke (+)	+ side position limit	×	×	●	Set in units of 0.01 mm
	Stroke (-)	- side position limit	×	×	●	Set in units of 0.01 mm
	ORIG direction	Direction of the return to origin can be set.	×	×	●	Compatible
	ORIG speed	Speed during return to origin	×	×	●	Set in units of 1 mm/s
	ORIG ACC	Acceleration during return to origin	×	×	●	Set in units of 1 mm/s ²
Test	JOG		●	●	●	Continuous operation at the set speed can be tested while the switch is being pressed.
	MOVE		×	●	●	Operation at the set distance and speed from the current position can be tested.
	Return to ORIG		●	●	●	Compatible
	Test drive	Operation of the specified step data	●	●	● (Continuous operation)	Compatible
	Forced output	ON/OFF of the output terminal can be tested.	×	×	●	Compatible
Monitor	DRV mon	Current position, speed, force, and the specified step data can be monitored.	●	●	●	Compatible
	In/Out mon	Current ON/OFF status of the input and output terminal can be monitored.	×	×	●	Compatible
ALM	Status	Alarm currently being generated can be confirmed.	●	●	●	Compatible
	ALM Log record	Alarms generated in the past can be confirmed.	×	×	●	Compatible
File	Save/Load	Step data and parameters can be saved, forwarded, and deleted.	×	×	●	Compatible
Other	Language	Can be changed to Japanese or English	●	●	●	Compatible

△: Can be set from TB Ver. 2.** (The version information is displayed on the initial screen.)

Fieldbus Network

EtherCAT/EtherNet/IP™/PROFINET

Direct Input Type

Step Motor Controller/JXC □ Series p. 36

Ether**CAT**®



Ether**Net/IP**™



PROFI®
NET



Two types of operation command

Step no. defined operation: Operate using the preset step data in the controller.

Numerical data defined operation: The actuator operates using values such as position and speed from the PLC.

Numerical monitoring available

Numerical information, such as the current speed, current position, and alarm codes, can be monitored on the PLC.

Transition wiring of communication cables

Two communication ports are provided.

PLC

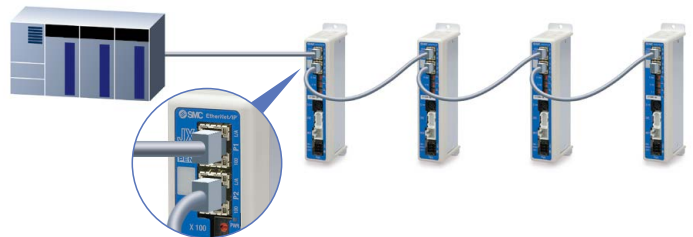

Application

Communication protocols

Ether**CAT**®

Ether**Net/IP**™

PROFI®
NET

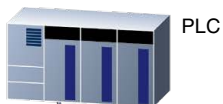

Both air and electric systems can be established under the same protocol.

Electric Actuators



Air Cylinders

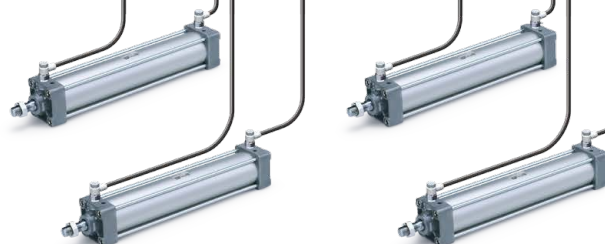
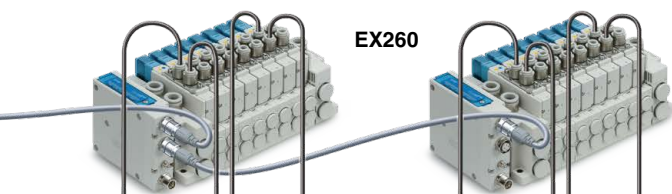

System Construction/General Purpose I/O

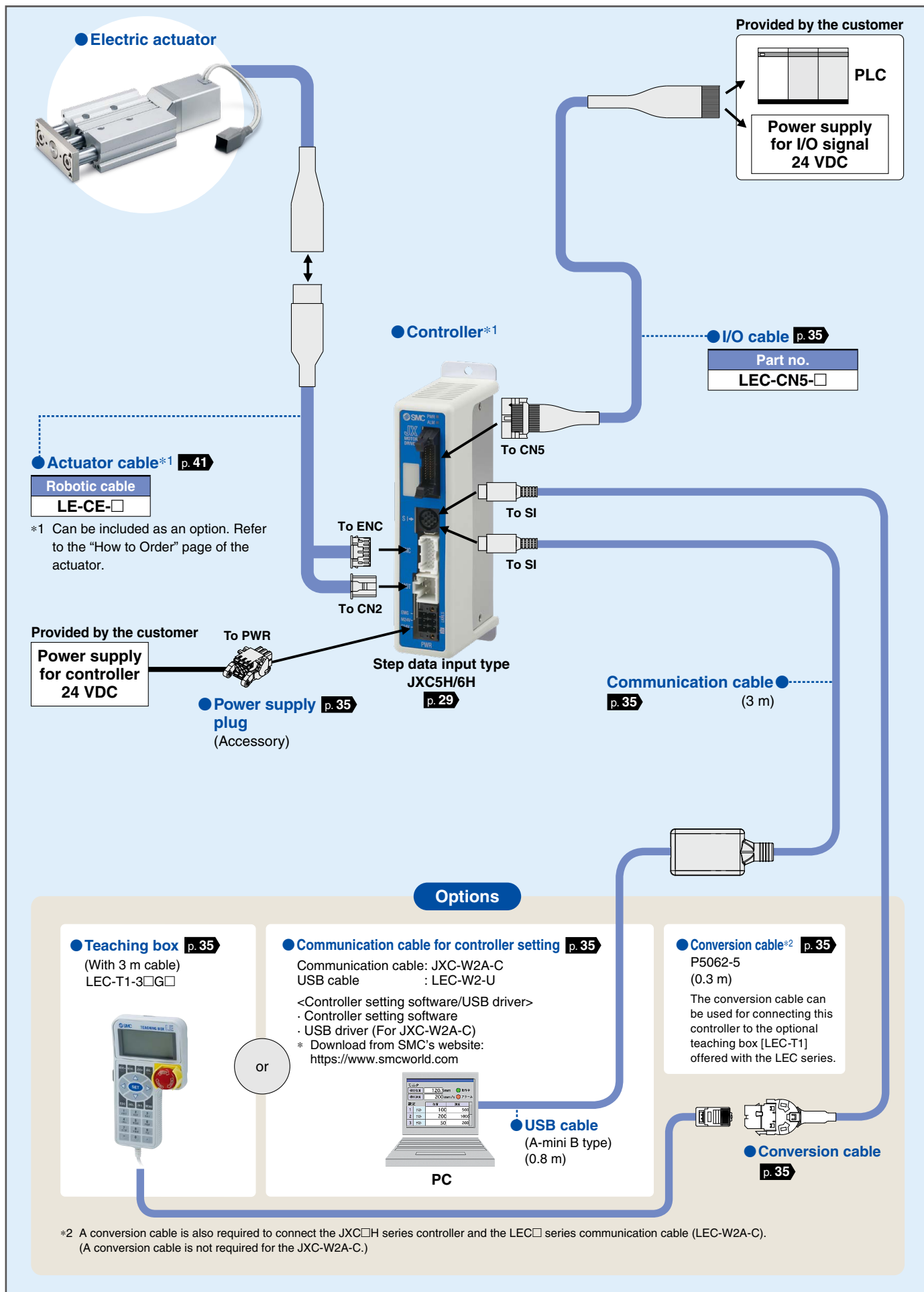

*2 A conversion cable is also required to connect the JXC□ series controller and the LEC□ series communication cable (LEC-W2A-C).
 (A conversion cable is not required for the JXC-W2A-C.)

System Construction/Fieldbus Network (EtherCAT/EtherNet/IP™/PROFINET Direct Input Type)

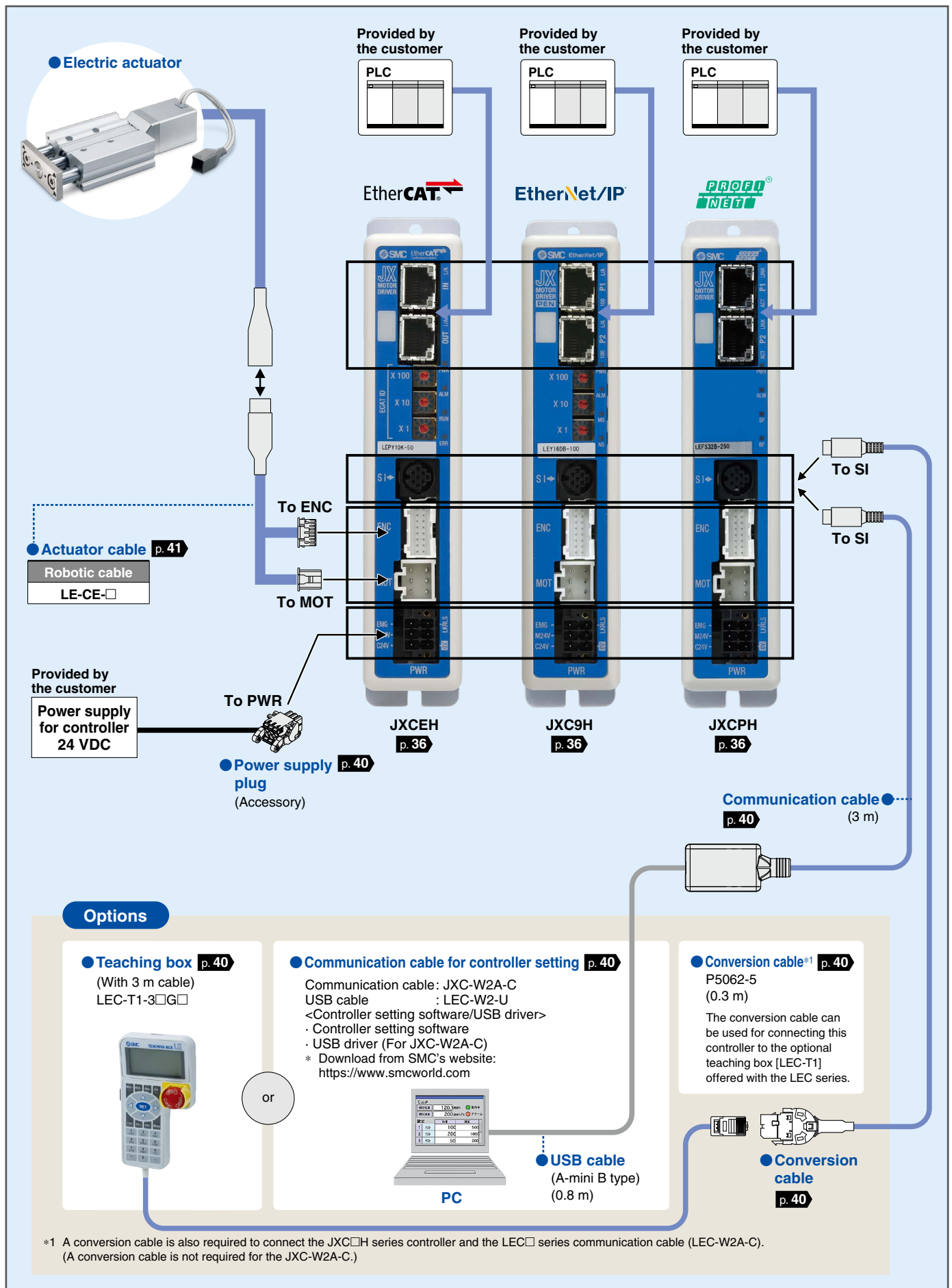

CONTENTS

High Performance High Rigidity Guide Rod Type *LEG Series* p. 10

Battery-less Absolute (Step Motor 24 VDC)

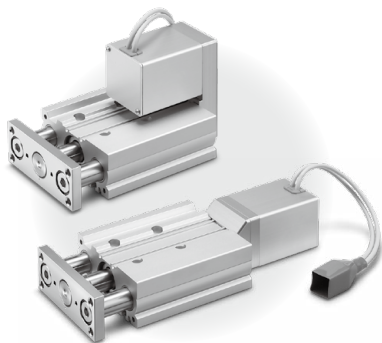

Model Selection	p. 11
How to Order	p. 15
Specifications	p. 17
Construction	p. 18
Dimensions	p. 20
Auto Switch	p. 22
Specific Product Precautions	p. 25

Controllers *JXC* Series p. 28

High Performance Controller (Step Data Input Type) *JXC5H/6H Series* Battery-less Absolute (Step Motor 24 VDC)



How to Order	p. 29
Specifications	p. 29
Dimensions	p. 31
Options	p. 35
Actuator Cable	p. 41

High Performance Step Motor Controller *JXCEH/9H/PH Series* Battery-less Absolute (Step Motor 24 VDC)



How to Order	p. 36
Specifications	p. 37
Dimensions	p. 38
Options	p. 40
Actuator Cable	p. 41

Battery-less Absolute Encoder Type Specific Product Precautions	p. 42
---	-------

CE/UKCA/UL-compliance List	p. 43
----------------------------------	-------

Electric Actuator

High Performance High Rigidity Guide Rod Type

High Rigidity Guide Rod Type *LEG Series*

Battery-less Absolute (Step Motor 24 VDC)

Top side parallel motor type

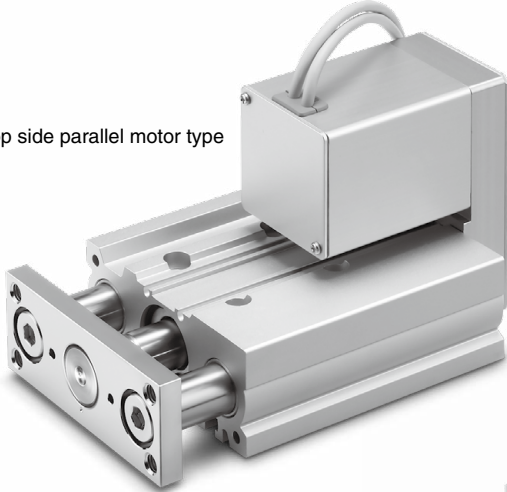

In-line motor type

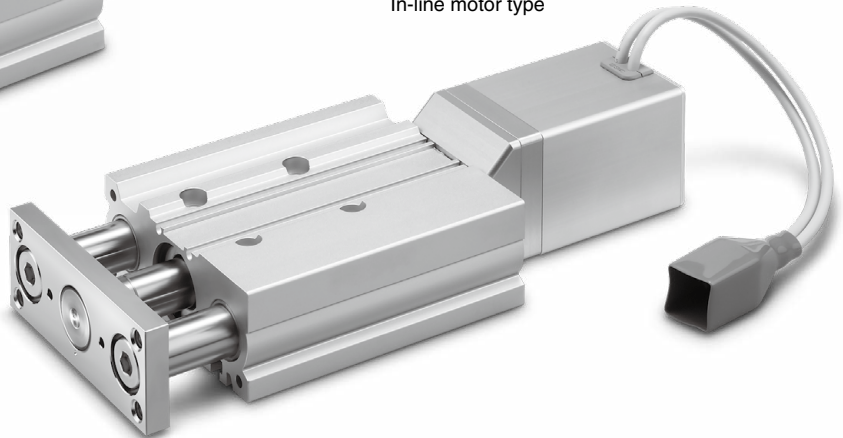

Controllers **p. 28**

Model Selection

LEG Series

Auto Switch

JXC5H/6H Series

JXCEH/9H/PH Series

Specific Product Precautions

High Performance

High Rigidity Guide Rod Type

LEG Series Battery-less Absolute (Step Motor 24 VDC)

Model Selection

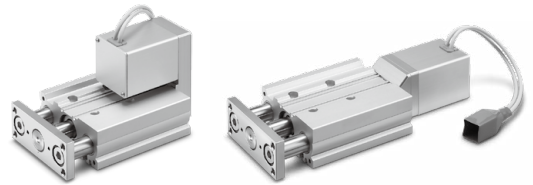

Moment Load Graph

Selection conditions

Mounting position	Vertical	Horizontal
Graph	Graphs ①, ②, ③	Graphs ④, ⑤, ⑥, ⑦, ⑧, ⑨

Vertical Mounting

① LEG25

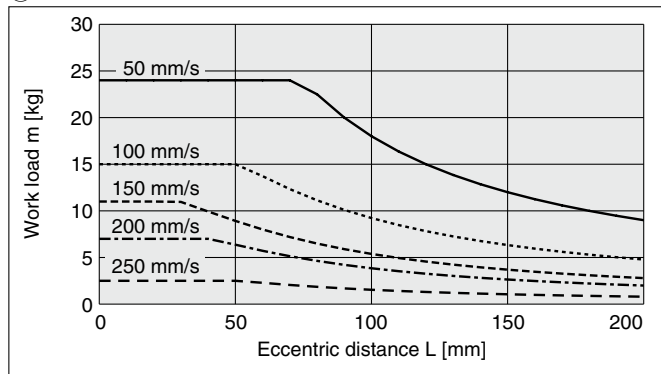

② LEG32

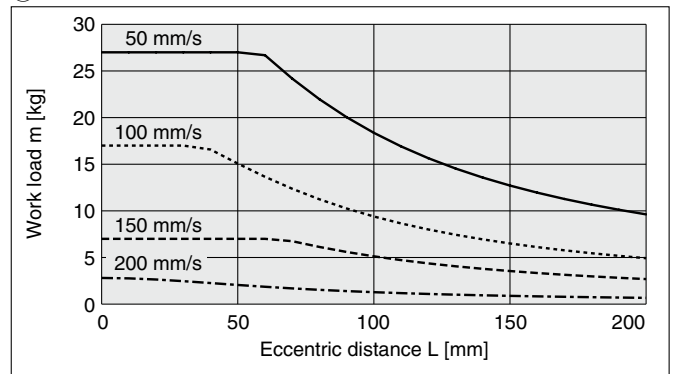

③ LEG40

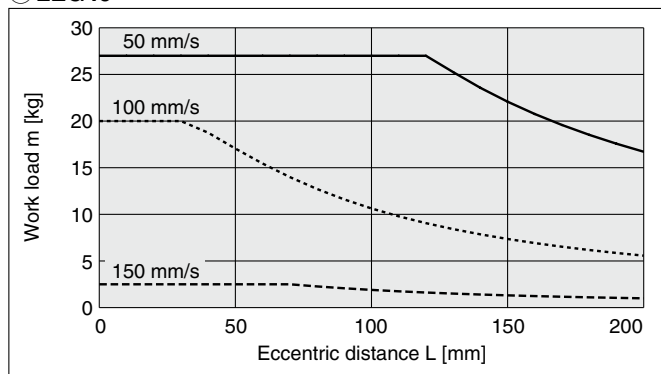

Moment Load Graph

Horizontal Mounting

④ LEG25 70 mm stroke or less

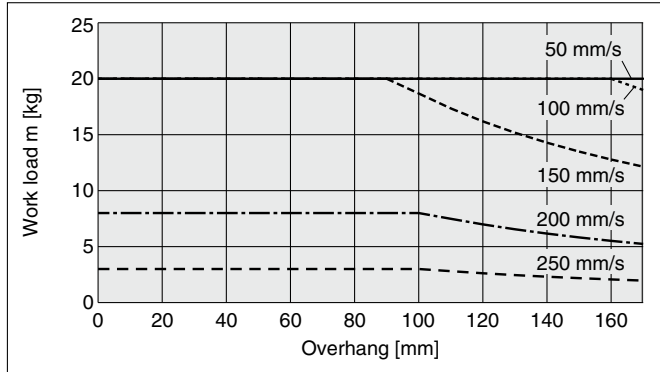

⑤ LEG25 71 mm stroke or more

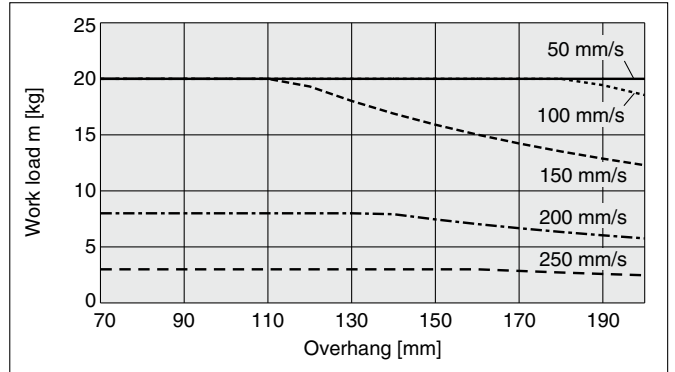

⑥ LEG32 70 mm stroke or less

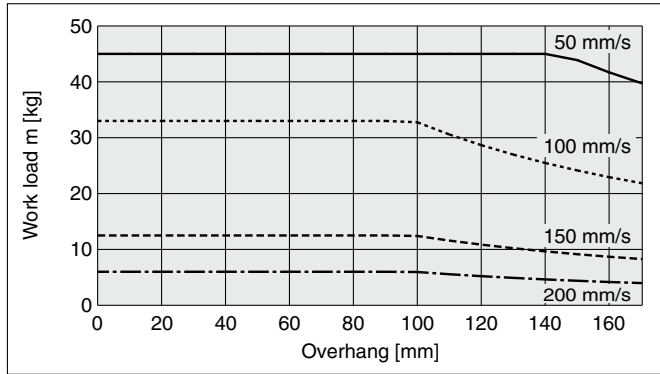

⑦ LEG32 71 mm stroke or more

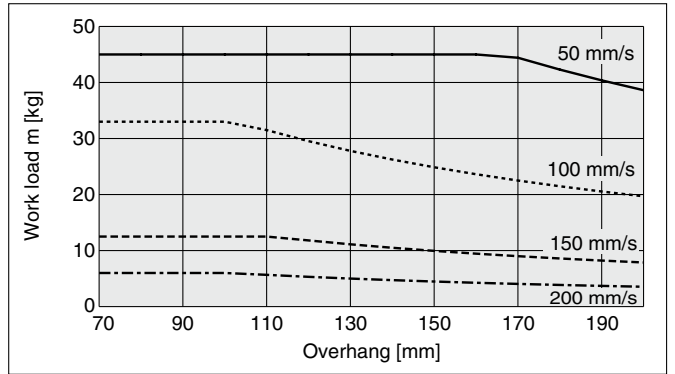

⑧ LEG40 70 mm stroke or less

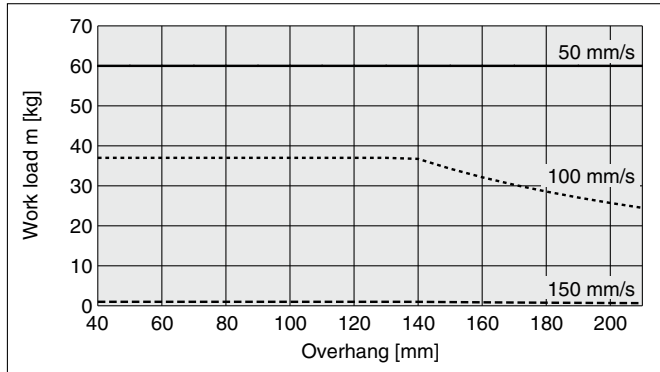

⑨ LEG40 71 mm stroke or more

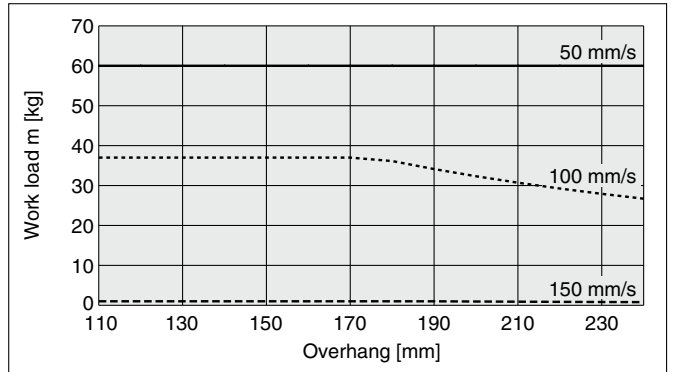

Operating Range when Used as a Stopper

LEG

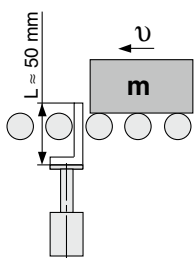

Fig. Collision direction a

Caution

Handling Precautions

- * When used as a stopper, select a model with a stroke of 50 mm or less.
- * Workpiece collision in series with guide rod cannot be permitted (Fig. b).

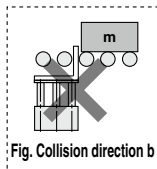
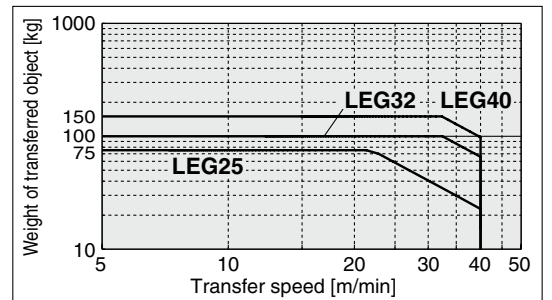

Fig. Collision direction b

Collision Direction a



Speed-Work Load Graph (Guide)

Vertical

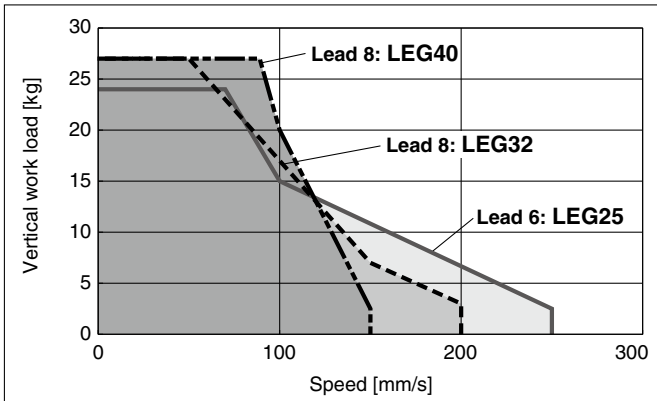

Horizontal

Horizontal (Acceleration: 5000 mm/s²)

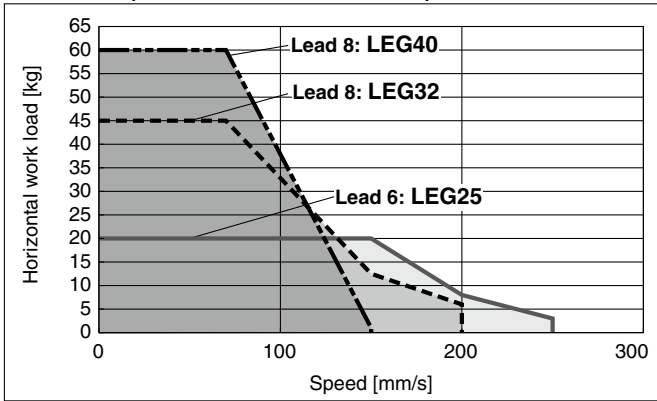

Horizontal (Acceleration: 3000 mm/s²)

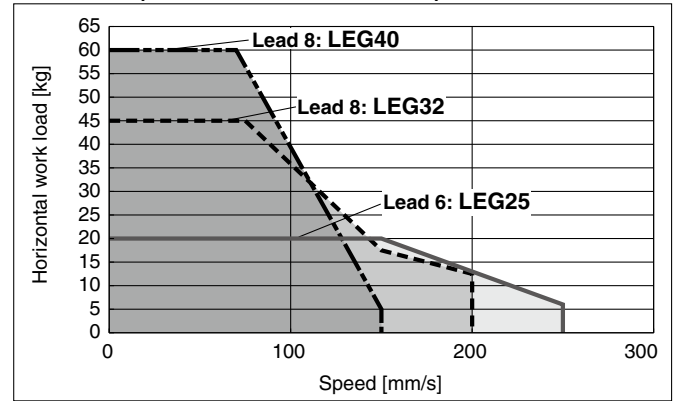

Force Conversion Graph (Guide)

LEG25

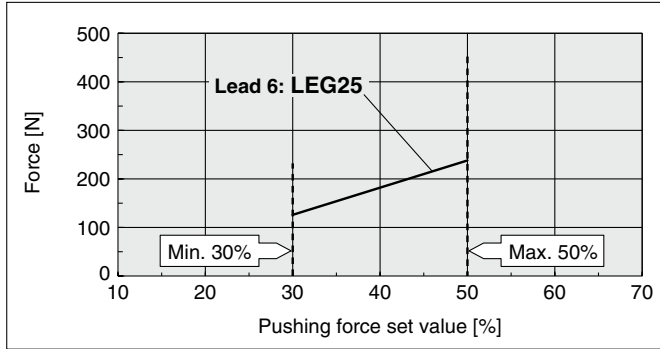

Ambient temperature	Pushing force set value [%]	Duty ratio [%]	Continuous pushing time [min]
40°C or less	50 or less	100	No restriction

<Set Values for Vertical Upward Transfer Pushing Operations>

For vertical loads (upward), set the pushing force to the max. value shown below and operate at the work load or less.

Model	LEG25	LEG32	LEG40
Work load [kg]	3.6	6.4	11.1
Pushing force	50%	70%	45%

LEG32

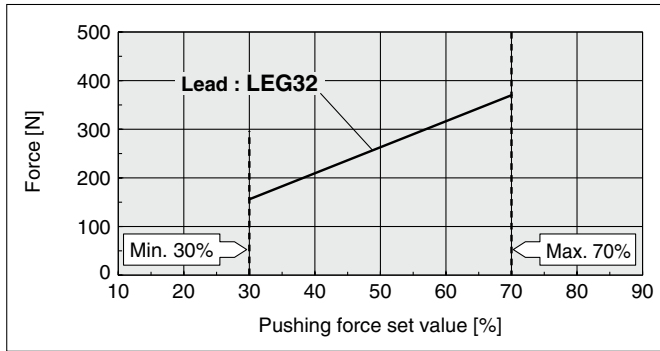

Ambient temperature	Pushing force set value [%]	Duty ratio [%]	Continuous pushing time [min]
40°C or less	70 or less	100	No restriction

LEG40

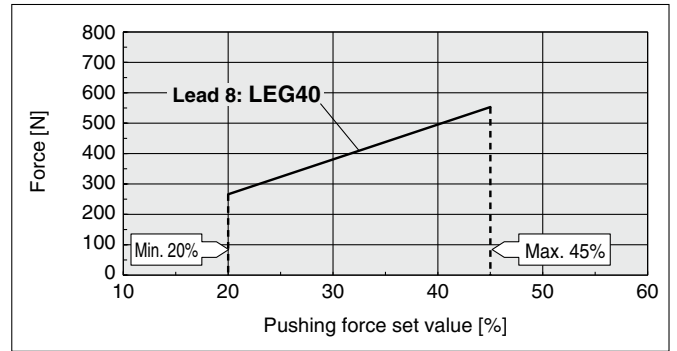

Ambient temperature	Pushing force set value [%]	Duty ratio [%]	Continuous pushing time [min]
40°C or less	45 or less	100	No restriction

Allowable Rotational Torque of Plate

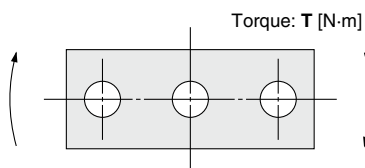

Size	T [N-m]		
	Stroke [mm]		
	30	50	100
25	6.05	5.13	4.97
32	12.45	10.80	10.60
40	14.05	12.10	11.90

Non-rotating Accuracy of Plate

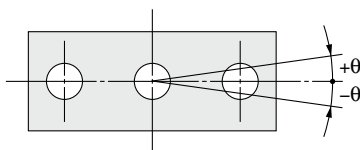

Size	Non-rotating accuracy θ
25	±0.05°
32	±0.04°
40	

High Performance

High Rigidity Guide Rod Type

LEG Series LEG25, 32, 40



* For details, refer to page 43 and onward.

How to Order

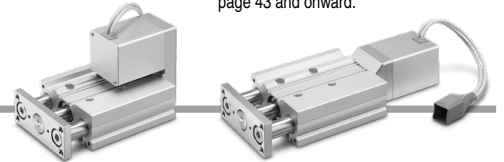

Motor mounting position:
Top side parallel

Motor mounting position:
In-line

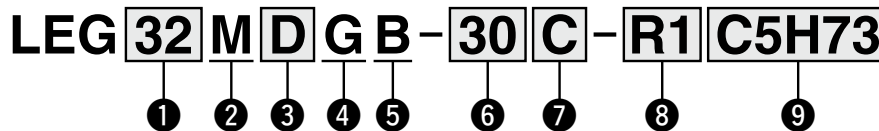

For details on controllers, refer to page 16.

1 Size

25
32
40

2 Bearing type

M	Sliding bearing
----------	-----------------

3 Motor mounting position*1

Nil	Top side parallel
D	In-line

*1 Motor mounting position: If the top side parallel motor type is selected, it is not possible to mount using through bolts on the motor side. Motor mounting position: Select the in-line motor type.

4 Motor type

Symbol	Type	Compatible controllers
G	High performance battery-less absolute (Step motor 24 VDC)	JXC5H JXC6H JXCEH JXC9H JXCPH

5 Lead [mm]

Symbol	LEG25	LEG32/40
B	6	8

6 Stroke [mm]*1

30	30
50	50
100	100

*1 When used as a stopper, select a model with a stroke of 50 mm or less.

7 Motor option

C	With motor cover
W	With lock/motor cover

8 Actuator cable type/length [m]

Symbol	Cable type	Motor type
		High performance battery-less absolute (Step motor 24 VDC)
Nil	None	None
R1	Robotic cable	1.5
R3		3
R5		5
R8		8*1
RA		10*1
RB		15*1
RC		20*1

*1 Produced upon receipt of order

For auto switches, refer to pages 22 to 24.



Use of auto switches for the high rigidity guide rod type LEG series

- Motor mounting position: Select the in-line motor type. Not possible to have a parallel mounting type.
- Auto switches must be inserted from the front side with the rod (plate) sticking out.

9 Controller

Nil	Without controller
C□H□□	With controller

C 5 H 7 3

Interface (Communication protocol/Input/Output)

5	Parallel input (NPN)
6	Parallel input (PNP)
E	EtherCAT
9	EtherNet/IP™
P	PROFINET

Mounting

7	Screw mounting
8	DIN rail

* The DIN rail is not included. It must be ordered separately.

Number of axes/Special specification

H	1 axis/High performance type
---	------------------------------

Communication plug connector, I/O cable

Symbol	Type
Nil	None
1	1.5 m
3	3 m
5	5 m

* Select "Nil" for anything other than the parallel I/O (NPN/PNP) type.

⚠ Caution

[CE-compliant products]

① EMC compliance was tested by combining the electric actuator LEG series and the controller JXC series.

The EMC depends on the configuration of the customer's control panel and the relationship with other electrical equipment and wiring. Therefore, compliance with the EMC directive cannot be certified for SMC components incorporated into the customer's equipment under actual operating conditions. As a result, it is necessary for the customer to verify compliance with the EMC directive for the machinery and equipment as a whole.

[Precautions relating to differences in controller versions]

When the JXC series is to be used in combination with the battery-less absolute encoder, use a controller that is version V3.4 or S3.4 or higher.

■ Trademark

EtherNet/IP® is a registered trademark of ODVA, Inc.
EtherCAT® is registered trademark and patented technology, licensed by Beckhoff Automation GmbH, Germany.

The actuator and controller are sold as a package.

Confirm that the combination of the controller and actuator is correct.

<Check the following before use.>

- ① Check the actuator label for the model number. This number should match that of the controller.
- ② Check that the Parallel I/O configuration matches (NPN or PNP).

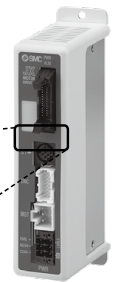
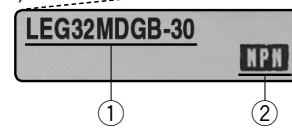

* Refer to the "Operation Manual" for using the products.
Please download it via our website: <https://www.smcworld.com>

Compatible Controllers

Type	Step data input type	EtherCAT direct input type	EtherNet/IP™ direct input type	PROFINET direct input type
Series	JXC5H JXC6H	JXCEH	JXC9H	JXCPH
Features	Parallel I/O	EtherCAT direct input	EtherNet/IP™ direct input	PROFINET direct input
Compatible motor	Step motor (Servo/24 VDC) Battery-less absolute (Step motor 24 VDC)			
Max. number of step data	64 points			
Power supply voltage	24 VDC			
Reference page	29		36	

Specifications

Model		LEG25	LEG32	LEG40	
Actuator specifications	Work load [kg]*1	Horizontal	20	45	60
		Vertical	24	27	27
	Max. weight of transferred object [kg]*2		75	100	150
	Pushing force [N]*3 *4 *5		126 to 238	156 to 370	266 to 553
	Speed [mm/s]*5		18 to 250	24 to 200	24 to 150
	Max. acceleration/deceleration [mm/s ²]		5000		
	Pushing speed [mm/s]*6		35 or less	30 or less	30 or less
	Positioning repeatability [mm]		±0.02		
	Screw lead [mm]		6	8	8
	Impact/Vibration resistance [m/s ²]*7		50/20		
	Actuation type		Ball screw + Belt (Top side parallel), Ball screw (In-line)		
	Guide type		Sliding bearing		
	Operating temperature range [°C]		5 to 40		
	Operating humidity range [%RH]		90 or less (No condensation)		
Enclosure		IP30			
Electric specifications	Motor size	□42	□56.4	□56.4	
	Motor type	Battery-less absolute (Step motor 24 VDC)			
	Encoder	Battery-less absolute			
	Power supply voltage [V]	24 VDC ±10%			
	Power [W]*8	Max. power 126	Max. power 159	Max. power 141	
Lock unit specifications	Type*9	Non-magnetizing lock			
	Holding force [N]	78	108	113	
	Power consumption [W]*10	5	5	5	
	Rated voltage [V]	24 VDC ±10%			

*1 Horizontal: Work load changes according to the distance from the plate to the centre of gravity of the load. Check the "Model Selection" on page 12.

Vertical: Speed changes according to the work load. Check the "Model Selection" on page 11.

The work load is changed by the eccentric distance. Check the "Model Selection" on page 13.

*2 This weight of transferred object is when using stopper.

*3 Pushing force accuracy is ±20% (F.S.).

*4 Pushing force is the set pushing force shown below. Pushing force varies depending on the motor size.

- LEG25: 30% to 50%, LEG32: 30% to 70%, LEG40: 20 to 45%

*5 The speed and force may change depending on the cable length, load, and mounting conditions. Furthermore, if the cable length exceeds 5 m, then it will decrease by up to 10% for each 5 m. (At 15 m: Reduced by up to 20%)

*6 The allowable speed for pushing operation

*7 Impact resistance: No malfunction occurred when the actuator was tested with a drop tester in both an axial direction and a perpendicular direction to the lead screw. (The test was performed with the actuator in the initial state.)

Vibration resistance: No malfunction occurred in a test ranging between 45 to 2000 Hz. The test was performed in both an axial direction and a perpendicular direction to the lead screw. (The test was performed with the actuator in the initial state.)

*8 Indicates the max. instantaneous power during operation (including the controller). This value can be used for the selection of the power supply.

*9 With lock only

*10 For an actuator with lock, add the power consumption for the lock.

Weight

Top Side Parallel

Series	LEG25M			LEG32M			LEG40M		
Stroke [mm]	30	50	100	30	50	100	30	50	100
Product weight [kg]	2.9	3.1	3.6	5.3	5.7	7.1	6.4	7.0	8.5
Additional weight with lock/motor cover [kg]	0.3			0.6			0.6		

In-line

Series	LEG25M			LEG32M			LEG40M		
Stroke [mm]	30	50	100	30	50	100	30	50	100
Product weight [kg]	2.8	3.0	3.5	5.1	5.6	6.9	6.2	6.8	8.3
Additional weight with lock/motor cover [kg]	0.3			0.6			0.6		

Construction

Top side parallel motor type

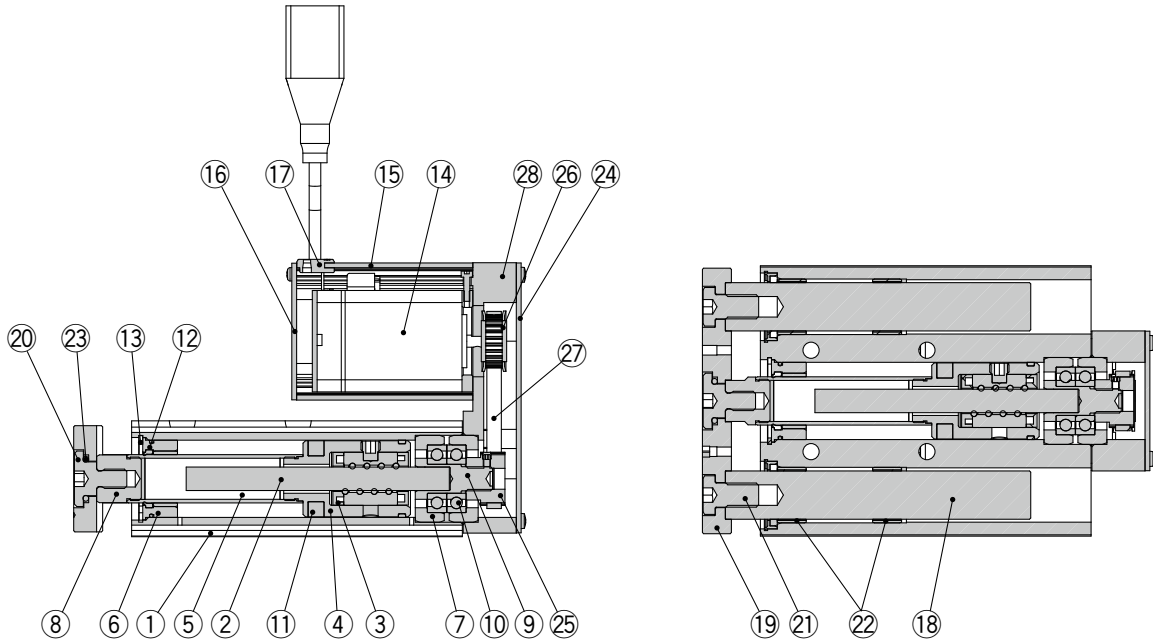

Component Parts

No.	Description	Material	Note
1	Body	Aluminum alloy	Anodized
2	Ball screw shaft	Alloy steel	
3	Ball screw nut	Synthetic resin/Alloy steel	
4	Piston	Aluminum alloy	
5	Piston rod	Stainless steel	Hard chrome plating
6	Rod cover	Aluminum alloy	
7	Bearing holder	Aluminum alloy	
8	Socket	Free cutting carbon steel	Nickel plating
9	Connected shaft	Free cutting carbon steel	Nickel plating
10	Bearing	—	
11	Magnet	—	
12	Scraper	NBR	
13	Retaining ring	Steel for spring	Phosphate coating
14	Motor	—	

No.	Description	Material	Note
15	Motor cover	Aluminum alloy	Anodized
16	End cover	Aluminum alloy	Anodized
17	Rubber bushing	NBR	
18	Guide rod	Carbon steel	Hard chrome plating
19	Plate	Carbon steel	Nickel plating
20	Plate mounting cap screw	Carbon steel	Nickel plating
21	Guide cap screw	Carbon steel	Nickel plating
22	Sliding bearing	Bearing alloy	
23	O-ring	NBR	
24	Return plate	Aluminum alloy	Anodized
25	Screw shaft pulley	Aluminum alloy	
26	Motor pulley	Aluminum alloy	
27	Belt	—	
28	Return box	Aluminum alloy	Anodized

Replacement Parts/Grease Pack

Applied portion	Order no.
Piston rod	GR-S-010 (10 g)
Guide rod	GR-S-020 (20 g)

* Apply grease periodically. Grease should be applied when 1 million cycles or 200 km have been reached, whichever comes first.

Replacement Parts/Belt

Size	Order no.
25	LE-D-15-1
32	LE-D-15-2
40	LE-D-15-3

Construction

In-line motor type

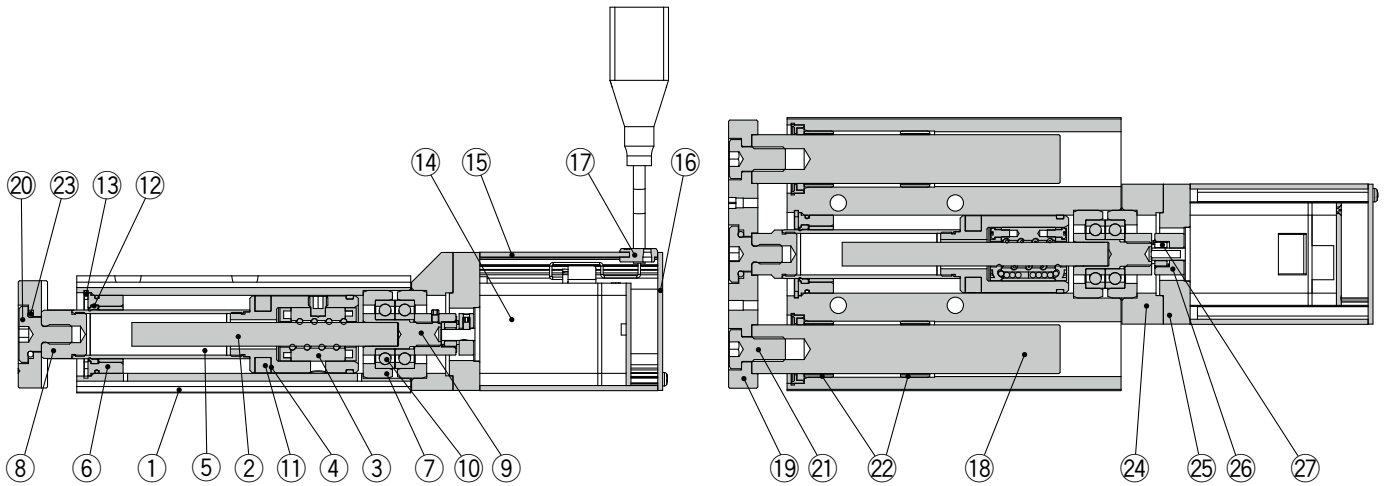

Component Parts

No.	Description	Material	Note
1	Body	Aluminum alloy	Anodized
2	Ball screw shaft	Alloy steel	
3	Ball screw nut	Synthetic resin/Alloy steel	
4	Piston	Aluminum alloy	
5	Piston rod	Stainless steel	Hard chrome plating
6	Rod cover	Aluminum alloy	
7	Bearing holder	Aluminum alloy	
8	Socket	Free cutting carbon steel	Nickel plating
9	Connected shaft	Free cutting carbon steel	Nickel plating
10	Bearing	—	
11	Magnet	—	
12	Scraper	NBR	
13	Retaining ring	Steel for spring	Phosphate coating
14	Motor	—	

No.	Description	Material	Note
15	Motor cover	Aluminum alloy	Anodized
16	End cover	Aluminum alloy	Anodized
17	Rubber bushing	NBR	
18	Guide rod	Carbon steel	Hard chrome plating
19	Plate	Carbon steel	Nickel plating
20	Plate mounting cap screw	Carbon steel	Nickel plating
21	Guide cap screw	Carbon steel	Nickel plating
22	Sliding bearing	Bearing alloy	
23	O-ring	NBR	
24	Motor block	Aluminum alloy	Anodized
25	Motor adapter	Aluminum alloy	Anodized (Sizes 25 and 40 only)
26	Hub	Aluminum alloy	
27	Spider	NBR	

Replacement Parts/Grease Pack

Applied portion	Order no.
Piston rod	GR-S-010 (10 g)
Guide rod	GR-S-020 (20 g)

* Apply grease periodically. Grease should be applied when 1 million cycles or 200 km have been reached, whichever comes first.

Dimensions: Top Side Parallel Motor

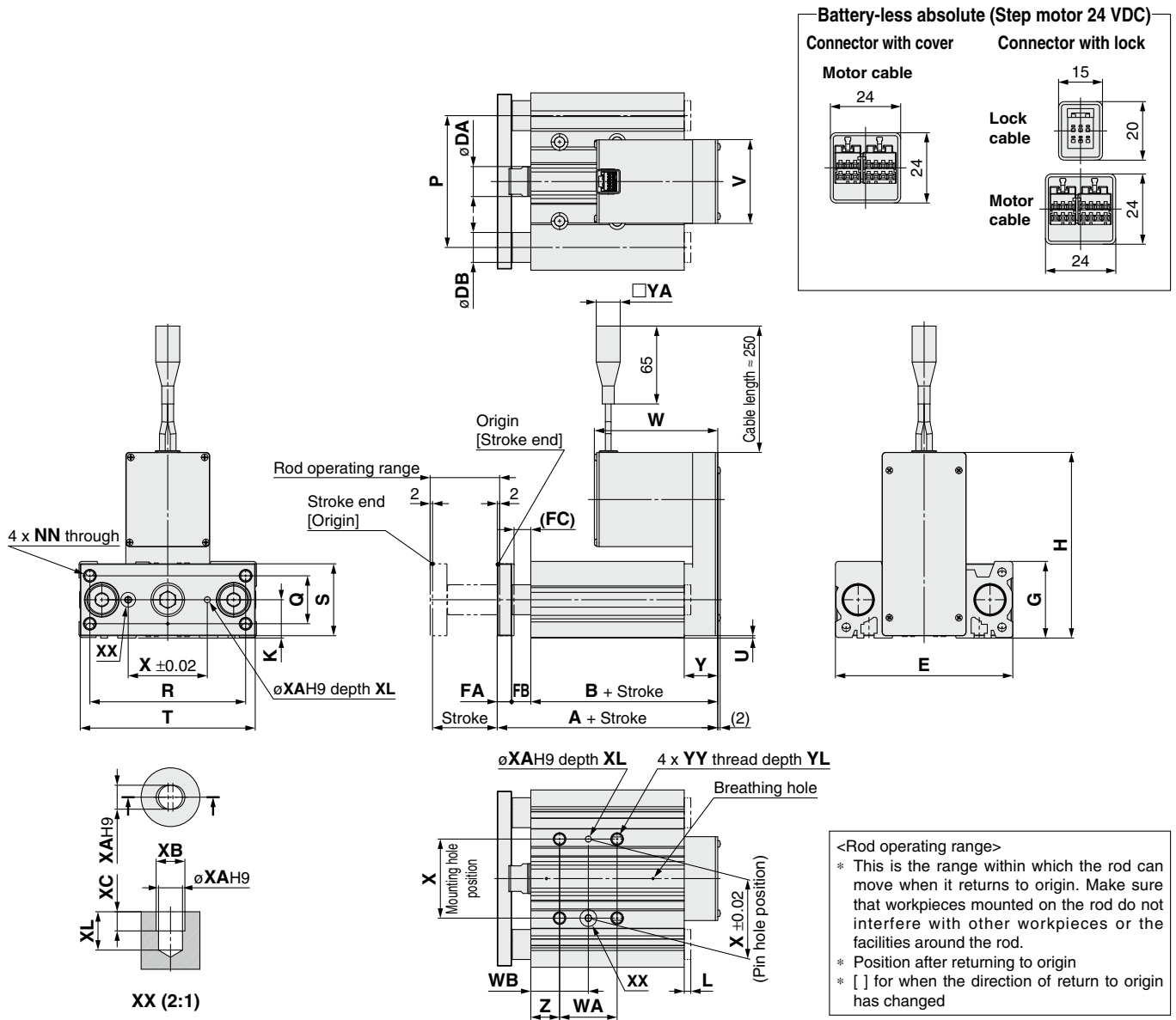

Dimensions

Size	Stroke	A	B	DA	DB	E	FA	FB	FC	G	H	K	NN	P	Q	R	S	T
25	30	135	111	20	20	112	12	12	10	48	113.5	24	M8 x 1.25	78	30	96	44	110
	50																	
	100																	
32	30	151	119	25	25	148	16	16	14	64	155	32	M10 x 1.5	110	40	130	60	146
	50																	
	100																	
40	30	151	119	25	25	162	16	16	14	78	168.5	39	M10 x 1.5	124	50	130	70	158
	50																	
	100																	

Size	Stroke	U	V	W		WA	WB	X	XA	XB	XC	XL	Y	YA	YL	YY	Z
				Without lock	With lock												
25	30	1.5	58	95	135	24	33	42	4	4.5	3	6	24	24	16	M8 x 1.25	21
	50					48	45										
	100					48	45										
32	30	2	70	101	141	24	36	66	5	6	4	8	28	24	20	M10 x 1.5	24
	50					48	48										
	100					48	48										
40	30	2.5	70	121	166	28	38	80	5	6	4	8	28	24	20	M10 x 1.5	24
	50					52	50										
	100					52	50										

Model Selection

LEG Series

Auto Switch

JXC5H/6H Series

JXCEH/9H/PH Series

Specific Product Precautions

Dimensions: In-line Motor

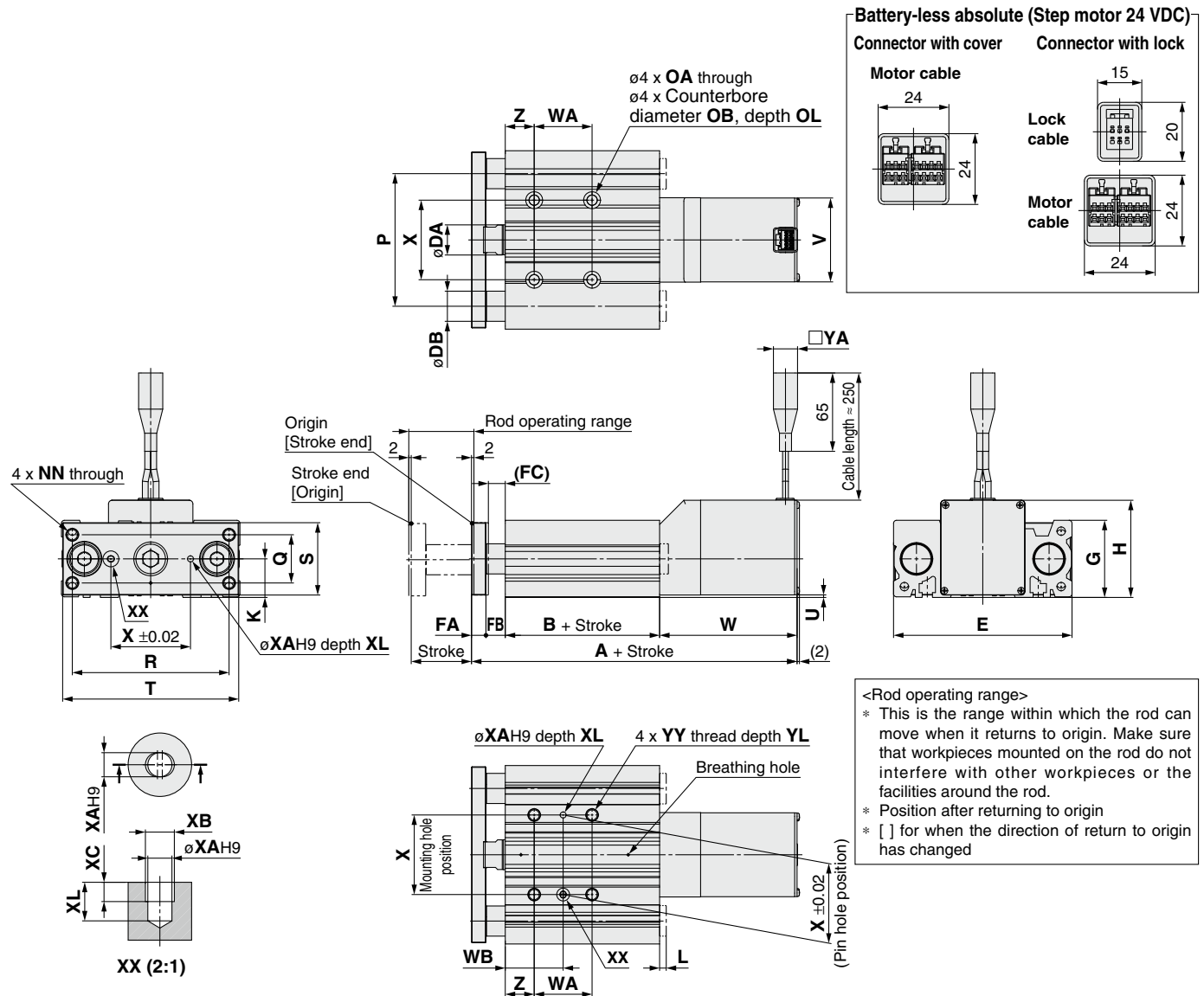

Dimensions

Size	Stroke	A		B	DA	DB	E	FA	FB	FC	G	H	K	NN	OA	OB	OL	P	Q
		Without lock	With lock																
25	30	214	254	87	20	20	112	12	12	10	48	57.7	24	M8 x 1.25	6.7	11	7.5	78	30
	50																		
	100																		
32	30	237	277	91	25	25	148	16	16	14	64	80.7	32	M10 x 1.5	8.6	14	9	110	40
	50																		
	100																		
40	30	257	302	91	25	25	162	16	16	14	78	81.1	39	M10 x 1.5	8.6	—	—	124	50
	50																		
	100																		

Size	Stroke	R	S	T	U	V	W		WA	WB	X	XA	XB	XC	XL	YA	YY	YL	Z
							Without lock	With lock											
25	30	96	44	110	0.9	57.6	103	143	24	33	42	4	4.5	3	6	24	M8 x 1.25	16	21
	50								48	45									
	100								48	45									
32	30	130	60	146	2	70	114	154	24	36	66	5	6	4	8	24	M10 x 1.5	20	24
	50								48	48									
	100								48	48									
40	30	130	70	158	2.5	70	134	179	28	38	80	5	6	4	8	24	M10 x 1.5	20	24
	50								52	50									
	100								52	50									

Solid State Auto Switch Direct Mounting Type D-M9N(V)/D-M9P(V)/D-M9B(V)

Refer to the SMC website for details on products that are compliant with international standards.

PLC: Programmable Logic Controller

Grommet

- 2-wire load current is reduced (2.5 to 40 mA).
- Using flexible cable as standard spec.



Caution

Precautions

Fix the auto switch with the existing screw installed on the auto switch body. The auto switch may be damaged if a screw other than the one supplied is used.

Auto Switch Specifications

D-M9□, D-M9□V (With indicator light)						
Auto switch model	D-M9N	D-M9NV	D-M9P	D-M9PV	D-M9B	D-M9BV
Electrical entry direction	In-line	Perpendicular	In-line	Perpendicular	In-line	Perpendicular
Wiring type	3-wire				2-wire	
Output type	NPN		PNP		—	
Applicable load	IC circuit, Relay, PLC				24 VDC relay, PLC	
Power supply voltage	5, 12, 24 VDC (4.5 to 28 V)				—	
Current consumption	10 mA or less				—	
Load voltage	28 VDC or less		—		24 VDC (10 to 28 VDC)	
Load current	40 mA or less				2.5 to 40 mA	
Internal voltage drop	0.8 V or less at 10 mA (2 V or less at 40 mA)				4 V or less	
Leakage current	100 μA or less at 24 VDC				0.8 mA or less	
Indicator light	Red LED illuminates when turned ON.					
Standard	CE marking, RoHS					

Oilproof Flexible Heavy-duty Lead Wire Specifications

Auto switch model		D-M9N(V)	D-M9P(V)	D-M9B(V)
Sheath	Outside diameter [mm]	2.6		
Insulator	Number of cores	3 cores (Brown/Blue/Black)		2 cores (Brown/Blue)
	Outside diameter [mm]	0.88		
Conductor	Effective area [mm ²]	0.15		
	Strand diameter [mm]	0.05		
Min. bending radius [mm] (Reference values)		17		

- * Refer to the **Web Catalog** for solid state auto switch common specifications.
- * Refer to the **Web Catalog** for lead wire lengths.

Weight

Auto switch model		D-M9N(V)	D-M9P(V)	D-M9B(V)
Lead wire length	0.5 m (Nil)	8	7	7
	1 m (M)	14	13	13
	3 m (L)	41	38	38
	5 m (Z)	68	63	63

Dimensions

D-M9□

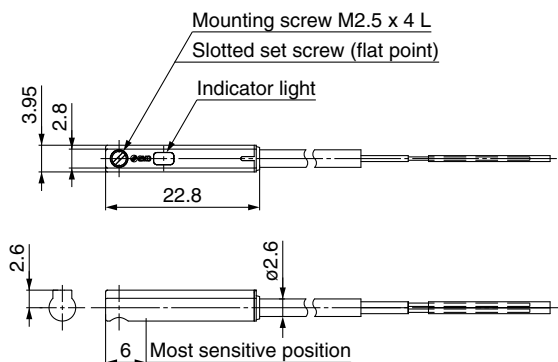

D-M9□V

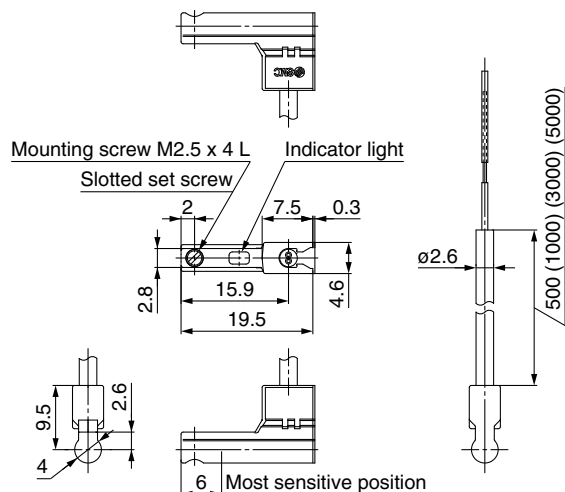

Normally Closed Solid State Auto Switch Direct Mounting Type

D-M9NE(V)/D-M9PE(V)/D-M9BE(V)



Refer to the SMC website for details on products that are compliant with international standards.

Grommet

- Output signal turns on when no magnetic force is detected.
- Can be used for the actuator adopted by the solid state auto switch D-M9 series (excluding special order products)



Caution

Precautions

Fix the auto switch with the existing screw installed on the auto switch body. The auto switch may be damaged if a screw other than the one supplied is used.

Auto Switch Specifications

PLC: Programmable Logic Controller

D-M9□E, D-M9□EV (With indicator light)						
Auto switch model	D-M9NE	D-M9NEV	D-M9PE	D-M9PEV	D-M9BE	D-M9BEV
Electrical entry direction	In-line	Perpendicular	In-line	Perpendicular	In-line	Perpendicular
Wiring type	3-wire				2-wire	
Output type	NPN		PNP		—	
Applicable load	IC circuit, Relay, PLC				24 VDC relay, PLC	
Power supply voltage	5, 12, 24 VDC (4.5 to 28 V)				—	
Current consumption	10 mA or less				—	
Load voltage	28 VDC or less		—		24 VDC (10 to 28 VDC)	
Load current	40 mA or less				2.5 to 40 mA	
Internal voltage drop	0.8 V or less at 10 mA (2 V or less at 40 mA)				4 V or less	
Leakage current	100 μA or less at 24 VDC				0.8 mA or less	
Indicator light	Red LED illuminates when turned ON.					
Standard	CE marking, RoHS					

Oilproof Flexible Heavy-duty Lead Wire Specifications

Auto switch model	D-M9NE(V)	D-M9PE(V)	D-M9BE(V)
Sheath	Outside diameter [mm]		
	2.6		
Insulator	Number of cores		2 cores (Brown/Blue)
	Outside diameter [mm]		0.88
Conductor	Effective area [mm ²]		0.15
	Strand diameter [mm]		0.05
Min. bending radius [mm] (Reference values)			17

- * Refer to the **Web Catalog** for solid state auto switch common specifications.
- * Refer to the **Web Catalog** for lead wire lengths.

Weight

[g]

Auto switch model	D-M9NE(V)	D-M9PE(V)	D-M9BE(V)
Lead wire length	0.5 m (Nil)	8	7
	1 m (M)*1	14	13
	3 m (L)	41	38
	5 m (Z)*1	68	63

*1 The 1 m and 5 m options are produced upon receipt of order.

Dimensions

[mm]

D-M9□E

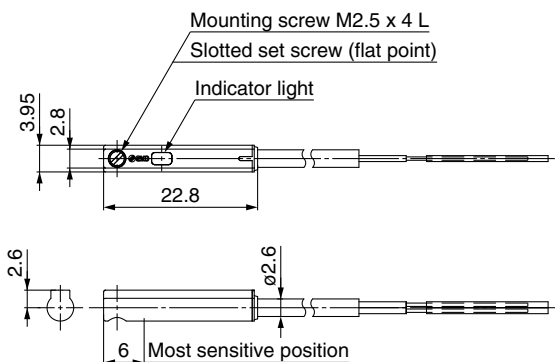

D-M9□EV

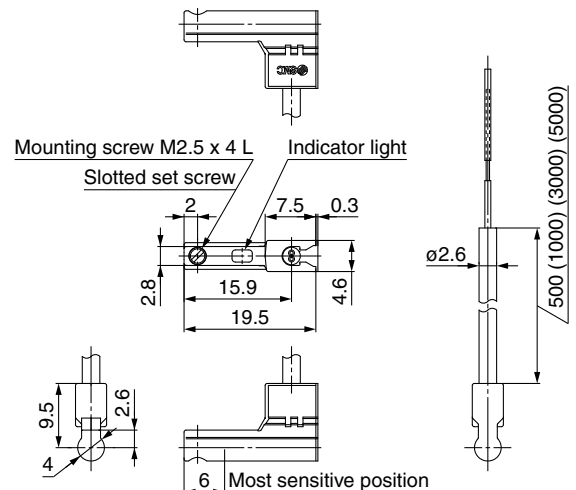

2-Color Indicator Solid State Auto Switch Direct Mounting Type

D-M9NW(V)/D-M9PW(V)/D-M9BW(V)



Refer to the SMC website for details on products that are compliant with international standards.

Grommet

- 2-wire load current is reduced (2.5 to 40 mA).
- Using flexible cable as standard spec.
- The proper operating range can be determined by the color of the light. (Red → Green ← Red)



Caution

Precautions
Fix the auto switch with the existing screw installed on the auto switch body. The auto switch may be damaged if a screw other than the one supplied is used.

Auto Switch Specifications

PLC: Programmable Logic Controller

D-M9□W, D-M9□WV (With indicator light)						
Auto switch model	D-M9NW	D-M9NWV	D-M9PW	D-M9PWV	D-M9BW	D-M9BWV
Electrical entry direction	In-line	Perpendicular	In-line	Perpendicular	In-line	Perpendicular
Wiring type	3-wire				2-wire	
Output type	NPN		PNP		—	
Applicable load	IC circuit, Relay, PLC				24 VDC relay, PLC	
Power supply voltage	5, 12, 24 VDC (4.5 to 28 V)				—	
Current consumption	10 mA or less				—	
Load voltage	28 VDC or less		—		24 VDC (10 to 28 VDC)	
Load current	40 mA or less				2.5 to 40 mA	
Internal voltage drop	0.8 V or less at 10 mA (2 V or less at 40 mA)				4 V or less	
Leakage current	100 μA or less at 24 VDC				0.8 mA or less	
Indicator light	Operating range Red LED illuminates. Proper operating range Green LED illuminates.					
Standard	CE marking, RoHS					

Oilproof Flexible Heavy-duty Lead Wire Specifications

Auto switch model		D-M9NW(V)	D-M9PW(V)	D-M9BW(V)
Sheath	Outside diameter [mm]	2.6		
Insulator	Number of cores	3 cores (Brown/Blue/Black)		2 cores (Brown/Blue)
	Outside diameter [mm]	0.88		
Conductor	Effective area [mm ²]	0.15		
	Strand diameter [mm]	0.05		
Min. bending radius [mm] (Reference values)		17		

- * Refer to the **Web Catalog** for solid state auto switch common specifications.
- * Refer to the **Web Catalog** for lead wire lengths.

Weight

[g]

Auto switch model		D-M9NW(V)	D-M9PW(V)	D-M9BW(V)
Lead wire length	0.5 m (Nil)	8	7	7
	1 m (M)	14	13	13
	3 m (L)	41	38	38
	5 m (Z)	68	63	63

Dimensions

[mm]

D-M9□W

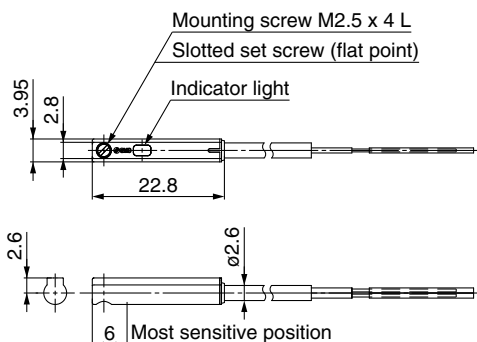

D-M9□WV

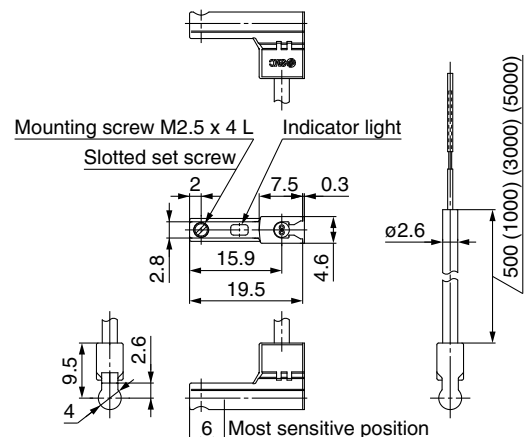



LEG Series Specific Product Precautions 1

Be sure to read this before handling the products. Refer to the back cover for safety instructions. For electric actuator and auto switch precautions, refer to the “Handling Precautions for SMC Products” and the “Operation Manual” on the SMC website: <https://www.smcworld.com>

Design / Selection

Warning

- Do not apply a load in excess of the specification limits.**
Select a suitable actuator by work load and allowable lateral load on the rod end. If a load in excess of the specification limits is applied to the piston rod, the generation of play in the piston rod sliding parts, reduced accuracy, etc., may occur and adversely affect the operation and service life of the product.
- Do not use the product in applications where excessive external force or impact force is applied to it.**
Doing so may result in a malfunction.
- When used as a stopper, select a model with a stroke of 50 mm or less.**

Handling

Warning

- Never place your hands or fingers between the plate and the body.**
Be very careful to prevent your hands or fingers from getting caught in the gap between the plate and the body when operating.

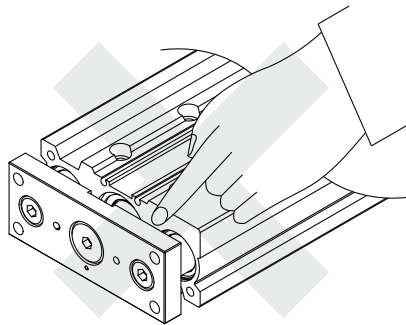

Caution

- INP output signal**
 - Positioning operation
When the product comes within the set range of the step data [In position], the INP output signal will turn ON.
Initial value: Set to [0.50] or higher.
 - Pushing operation
When the effective force exceeds the step data [Trigger LV], the INP output signal will turn ON.
Use the product within the specified range of the [Pushing force] and [Trigger LV].
 - To ensure that the actuator pushes the workpieces with the set [Pushing force], it is recommended that the [Trigger LV] be set to the same value as the [Pushing force].
 - When the [Pushing force] and the [Trigger LV] are set below the specified range, the INP output signal will turn ON from the pushing start position.

Handling

Caution

- Battery-less absolute (Step motor 24 VDC)**

<Limit Values for Pushing Force and Trigger Level in Relation to Pushing Speed>

Model	Pushing speed [mm/s]	Pushing force (Setting input value)
LEG25M	21 to 35	40 to 50%
LEG32M	24 to 30	50 to 70%
LEG40M	24 to 30	50 to 65%

There is a limit to the pushing force in relation to the pushing speed. If the product is operated outside of the range (low pushing force), the completion signal [INP] may be output before the pushing operation has been completed (during the moving operation).

If operating with the pushing speed below the min. speed, please check for operating problems before using the product.

<Set Values for Vertical Upward Transfer Pushing Operations>

For vertical loads (upward), set the pushing force to the max. value shown below and operate at the work load or less.

Model	LEG25	LEG32	LEG40
Work load [kg]	3.6	6.4	11.1
Pushing force	50%	70%	45%

- To conduct a pushing operation, be sure to set the product to [Pushing operation].**
Also, refrain from bumping the workpiece during a positioning operation or when in the range of the positioning operation. Failure to do so may result in a malfunction.
- Use the product within the specified pushing speed range for the pushing operation.**
Failure to do so may result in damage or malfunction.
- The moving force should be the initial value (100%).**
If the moving force is set below the initial value, it may cause the generation of an alarm.
- The actual speed of this actuator is affected by the load.**
Check the model selection section of the catalog.
- Do not apply a load, impact, or resistance in addition to the transferred load during return to origin.**
Additional force will cause the displacement of the origin position since it is based on the detected motor torque.
- For pushing operations, set the product to a position at least 2 mm away from a workpiece. (This position is referred to as the pushing start position.)**
The following alarms may be generated and operation may become unstable if setting is not done correctly.
 - “Posn failed”**
The product cannot reach the pushing start position due to variations in the target positions.
 - “Pushing ALM”**
The product is pushed back from the pushing start position after starting to push.
- Do not scratch or dent the sliding parts of the piston rod and guide rod by bumping them or placing objects on them.**
The piston rod and guide rod are manufactured to precise tolerances, so even a slight deformation may result in a malfunction.



LEG Series Specific Product Precautions 2

Be sure to read this before handling the products. Refer to the back cover for safety instructions. For electric actuator and auto switch precautions, refer to the “Handling Precautions for SMC Products” and the “Operation Manual” on the SMC website: <https://www.smcworld.com>

Handling

Caution

9. Do not operate by fixing the plate and moving the actuator body.

Excessive load will be applied to the guide rod, resulting in damage to the actuator and a reduced service life of the product.

10. When rotational torque is applied to the end of the plate, use it within the allowable range.

Failure to do so may result in the deformation of the guide rod and bushing, play in the guide, or an increase in the sliding resistance.

11. When mounting the product, secure a space of 40 mm or more to allow for bends in the cable.

* Failure to do so may result in cable breakage.

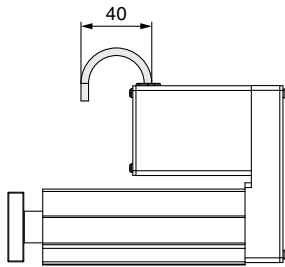

12. When mounting the product and/or a workpiece, tighten the mounting screws within the specified torque range.

Tightening the screws with a higher torque than recommended may result in a malfunction, while tightening with a lower torque can result in the displacement of the mounting position or, in extreme conditions, the actuator could become detached from its mounting position.

Workpiece fixed/Plate tapped type

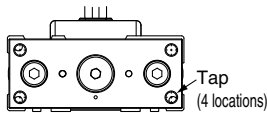

Model	Screw size	Max. tightening torque [N·m]	Max. screw-in depth [mm]
LEG25	M8 x 1.25	12.5	12
LEG32/LEG40	M10 x 1.5	24	16

Body fixed/Top mounting

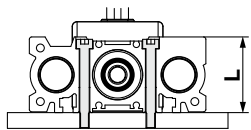

Model	Screw size	Max. tightening torque [N·m]	Length: L [mm]
LEG25	M6 x 1.0	5.2	48
LEG32	M8 x 1.25	12.5	64
LEG40	M8 x 1.25	12.5	78

Body fixed/Bottom mounting

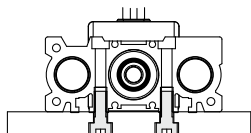

Model	Screw size	Max. tightening torque [N·m]	Max. screw-in depth [mm]
LEG25	M8 x 1.25	12.5	20
LEG32/LEG40	M10 x 1.5	24	20

13. Keep the flatness of the mounting surface within the following ranges when mounting the actuator body and workpiece.

Mounting the product on an uneven workpiece or base may result in an increase in the sliding resistance.

Model	Mounting position	Flatness
LEG□	Top mounting/Bottom mounting 	0.02 mm or less
	Workpiece/Plate mounting 	0.02 mm or less

14. Do not dent or scratch the mounting surface of the body and the plate.

Doing so may cause a decrease in the flatness of the mounting surface, which will cause an increase in sliding resistance.

15. Do not operate the actuator in a state where lateral loads are applied.

The actuator may not operate due to the friction force generated between the conveyor and the transferred object.



LEG Series Specific Product Precautions 3

Be sure to read this before handling the products. Refer to the back cover for safety instructions. For electric actuator and auto switch precautions, refer to the “Handling Precautions for SMC Products” and the “Operation Manual” on the SMC website: <https://www.smcworld.com>

Maintenance

Warning

1. Ensure that the power supply is stopped and the workpiece is removed before starting maintenance work or replacing the product.

• Maintenance frequency

Perform maintenance according to the table below.

Frequency	Appearance check	Belt check
Inspection before daily operation	○	—
Inspection every 6 months/ 250 km/5 million cycles*1	○	○

*1 Select whichever comes first.

• Items for visual appearance check

1. Loose set screws, Abnormal amount of dirt, etc.
2. Check for visible damage, Check of cable joint
3. Vibration, Noise

• Items for belt check

Stop operation immediately and replace the belt when any of the following occur. In addition, ensure your operating environment and conditions satisfy the requirements specified for the product.

a. Tooth shape canvas is worn out

Canvas fiber becomes fuzzy, Rubber is coming off and the fiber has become whitish, Lines of fibers have become unclear

b. Peeling off or wearing of the side of the belt

Belt corner has become rounded and frayed threads stick out

c. Belt is partially cut

Belt is partially cut, Foreign matter caught in the teeth of other parts is causing damage

d. A vertical line on belt teeth is visible

Damage which is made when the belt runs on the flange

e. Rubber back of the belt is softened and sticky

f. Cracks on the back of the belt are visible

Controllers

JXC□ Series



Step Data Input Type p. 29

High Performance

Battery-less Absolute (Step Motor 24 VDC)

JXC5H/6H Series



EtherCAT/EtherNet/IP™/PROFINET Direct Input Type p. 36

High Performance

Battery-less Absolute (Step Motor 24 VDC)

JXCEH/9H/PH Series

EtherCAT®

EtherNet/IP®

PROFINET®



● Actuator Cable **p. 41**

Model Selection

LEG Series

Auto Switch

JXC5H/6H Series

JXCEH/9H/PH Series

Specific Product Precautions

High Performance Controller (Step Data Input Type)

JXC5H/6H Series



— For details, refer to page 43 and onward. —



How to Order

JXC **5** **H** **7** **3** - **□**

① ② ③ ④ ⑤

① Controller type

5	Parallel I/O (NPN) type
6	Parallel I/O (PNP) type

② Specification

H	High performance type
---	-----------------------

③ Mounting

7	Screw mounting
8	DIN rail

④ I/O cable length

Nil	None
1	1.5 m
3	3 m
5	5 m

⑤ Actuator part number

Without cable specifications and actuator options Example: Enter "LEG32MDGB-30" for the LEG32MDGB-30C-R1C□1□□.	
BC	Blank controller*1

*1 Requires dedicated software (JXC-BCW)

The controller is sold as single unit after the compatible actuator is set.

Confirm that the combination of the controller and actuator is correct.

<Check the following before use.>

- ① Check the actuator label for the model number. This number should match that of the controller.
- ② Check that the Parallel I/O configuration matches (NPN or PNP).

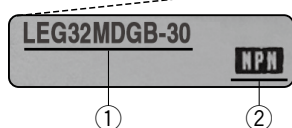

⚠ Caution

[CE/UKCA-compliant products]

EMC compliance was tested by combining the electric actuator LEG series and the controller JXC series.

The EMC depends on the configuration of the customer's control panel and the relationship with other electrical equipment and wiring. Therefore, compliance with the EMC directive cannot be certified for SMC components incorporated into the customer's equipment under actual operating conditions. As a result, it is necessary for the customer to verify compliance with the EMC directive for the machinery and equipment as a whole.

* Refer to the "Operation Manual" for using the products. Please download it via our website: <https://www.smcworld.com>

Specifications

Model	JXC5H JXC6H
Compatible motor	Step motor (Servo/24 VDC)
Power supply	Power supply voltage: 24 VDC ±10%
Current consumption (Controller)	100 mA or less
Compatible encoder	Battery-less absolute
Parallel input	11 inputs (Photo-coupler isolation)
Parallel output	13 outputs (Photo-coupler isolation)
Serial communication	RS485 (Only for the LEC-T1 and JXC-W2)
Memory	EEPROM
LED indicator	PWR, ALM
Cable length [m]	Actuator cable: 20 or less
Cooling system	Natural air cooling
Operating temperature range [°C]	0 to 40
Operating humidity range [%RH]	90 or less (No condensation)
Enclosure	IP30 (Excludes the connector)
Insulation resistance [MΩ]	Between all external terminals and the case: 50 (500 VDC)
Weight [g]	180 (Screw mounting), 200 (DIN rail mounting)

How to Mount

a) Screw mounting (JXC□H7□) (Installation with two M4 screws)

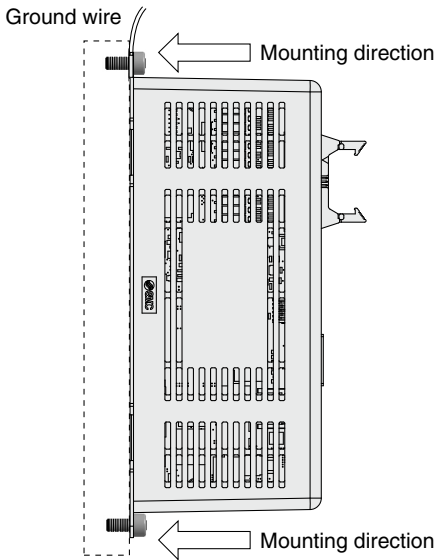

b) DIN rail mounting (JXC□H8□) (Installation with the DIN rail)

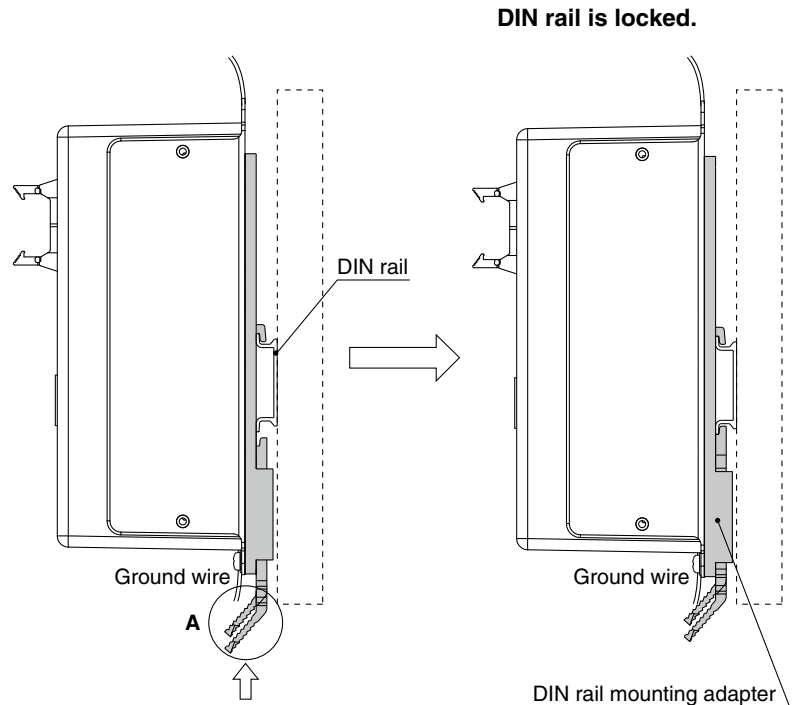

Hook the controller on the DIN rail and press the lever of section A in the arrow direction to lock it.

* When size 25 or more of the LE series are used, the space between the controllers should be 10 mm or more.

DIN rail AXT100-DR-□

* For □, enter a number from the No. line in the table below.
Refer to the dimension drawings on page 31 for the mounting dimensions.

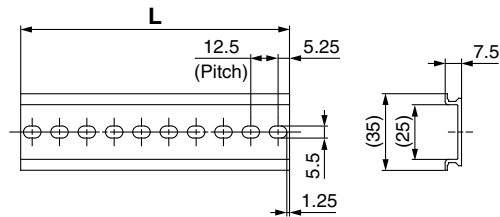

L Dimensions [mm]

No.	1	2	3	4	5	6	7	8	9	10	11	12	13	14	15	16	17	18	19	20
L	23	35.5	48	60.5	73	85.5	98	110.5	123	135.5	148	160.5	173	185.5	198	210.5	223	235.5	248	260.5
No.	21	22	23	24	25	26	27	28	29	30	31	32	33	34	35	36	37	38	39	40
L	273	285.5	298	310.5	323	335.5	348	360.5	373	385.5	398	410.5	423	435.5	448	460.5	473	485.5	498	510.5

DIN rail mounting adapter LEC-3-D0 (with 2 mounting screws)

This should be used when the DIN rail mounting adapter is mounted onto a screw mounting type controller afterward.

Model Selection

LEG Series

Auto Switch

JXC5H/6H Series

JXCEH/9H/PH Series

Specific Product Precautions

JXC5H/6H Series

Dimensions

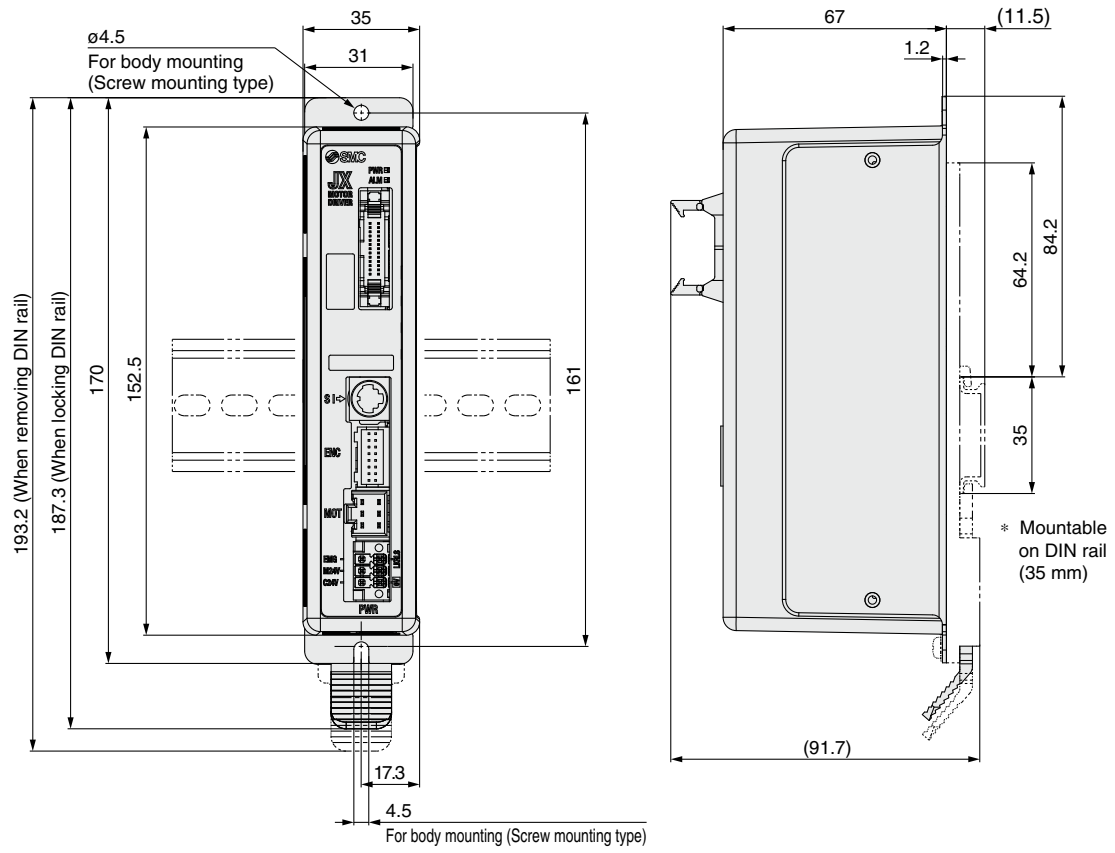

Wiring Example 1

Parallel I/O Connector

- * When you connect a PLC to the parallel I/O connector, use the I/O cable (LEC-CN5-□).
- * The wiring changes depending on the type of parallel I/O (NPN or PNP).

Wiring diagram JXC5H□□ (NPN)

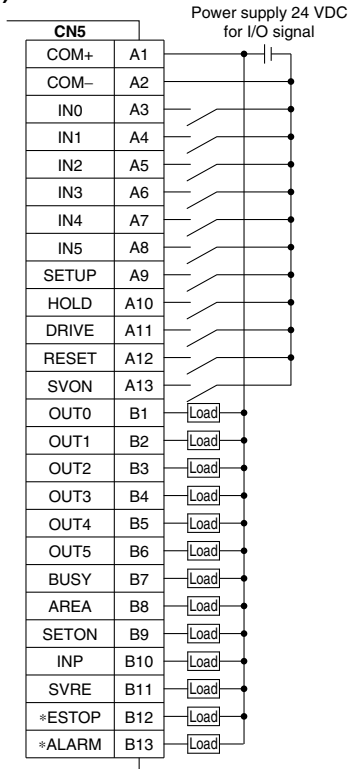

JXC6H□□ (PNP)

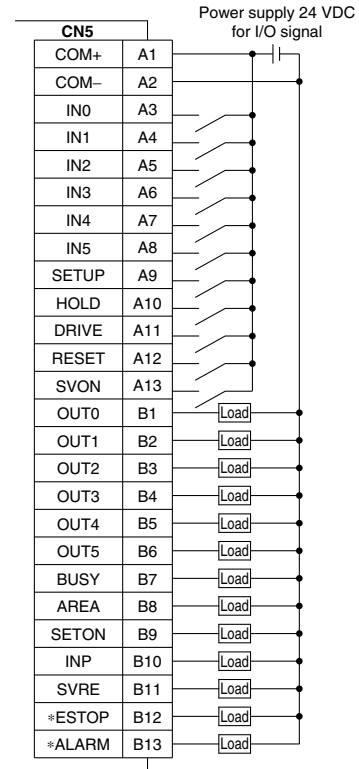

Input Signal

Name	Details
COM+	Connects the power supply 24 V for input/output signal
COM-	Connects the power supply 0 V for input/output signal
IN0 to IN5	Step data specified bit no. (Input is instructed by combining IN0 to 5.)
SETUP	Instruction to return to origin
HOLD	Temporarily stops operation
DRIVE	Instruction to drive
RESET	Resets alarm and interrupts operation
SVON	Servo ON instruction

Output Signal

Name	Details
OUT0 to OUT5	Outputs the step data no. during operation
BUSY	Outputs when the actuator is moving
AREA	Outputs within the step data area output setting range
SETON	Outputs when returning to origin
INP	Outputs when target position or target force is reached (Turns on when the positioning or pushing is completed.)
SVRE	Outputs when servo is on
ESTOP ^{*1}	OFF when EMG stop is instructed
ALARM ^{*1}	OFF when alarm is generated

*¹ Signal of negative-logic circuit (N.C.)

Model Selection

LEG Series

Auto Switch

JXC5H/6H Series

JXCEH/9H/PH Series

Specific Product Precautions

Step Data Setting

1. Step data setting for positioning

In this setting, the actuator moves toward and stops at the target position.

The following diagram shows the setting items and operation. The setting items and set values for this operation are stated below.

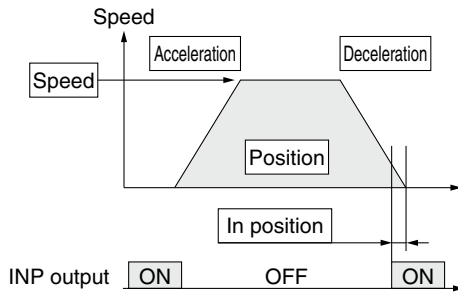

◎ : Need to be set.
○ : Need to be adjusted as required.
— : Setting is not required.

Step Data (Positioning)

Necessity	Item	Details
◎	Movement MOD	When the absolute position is required, set Absolute. When the relative position is required, set Relative.
◎	Speed	Transfer speed to the target position
◎	Position	Target position
○	Acceleration	Parameter which defines how rapidly the actuator reaches the speed set. The higher the set value, the faster it reaches the speed set.
○	Deceleration	Parameter which defines how rapidly the actuator comes to stop. The higher the set value, the quicker it stops.
◎	Pushing force	Set 0. (If values 1 to 100 are set, the operation will be changed to the pushing operation.)
—	Trigger LV	Setting is not required.
—	Pushing speed	Setting is not required.
○	Moving force	Max. torque during the positioning operation (No specific change is required.)
○	Area 1, Area 2	Condition that turns on the AREA output signal.
○	In position	Condition that turns on the INP output signal. When the actuator enters the range of [in position], the INP output signal turns on. (It is unnecessary to change this from the initial value.) When it is necessary to output the arrival signal before the operation is completed, make the value larger.

2. Step data setting for pushing

The actuator moves toward the pushing start position, and when it reaches that position, it starts pushing with the set force or less.

The following diagram shows the setting items and operation. The setting items and set values for this operation are stated below.

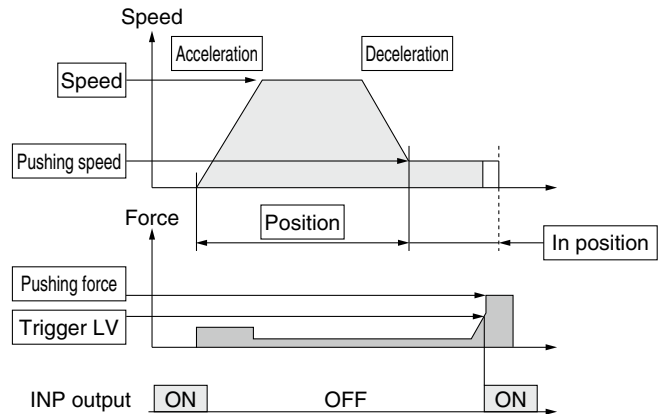

◎ : Need to be set.
○ : Need to be adjusted as required.

Step Data (Pushing)

Necessity	Item	Details
◎	Movement MOD	When the absolute position is required, set Absolute. When the relative position is required, set Relative.
◎	Speed	Transfer speed to the pushing start position
◎	Position	Pushing start position
○	Acceleration	Parameter which defines how rapidly the actuator reaches the speed set. The higher the set value, the faster it reaches the speed set.
○	Deceleration	Parameter which defines how rapidly the actuator comes to stop. The higher the set value, the quicker it stops.
◎	Pushing force	Pushing force ratio is defined. The setting range differs depending on the electric actuator type. Refer to the operation manual for the electric actuator.
◎	Trigger LV	Condition that turns on the INP output signal. The INP output signal turns on when the generated force exceeds the value. Trigger level should be the pushing force or less.
○	Pushing speed	Pushing speed during pushing. When the speed is set fast, the electric actuator and workpieces might be damaged due to the impact when they hit the end, so this set value should be smaller. Refer to the operation manual for the electric actuator.
○	Moving force	Max. torque during the positioning operation (No specific change is required.)
○	Area 1, Area 2	Condition that turns on the AREA output signal.
◎	In position	Transfer distance during pushing. If the transferred distance exceeds the setting, it stops even if it is not pushing. If the transfer distance is exceeded, the INP output signal will not turn on.

Signal Timing

Return to Origin

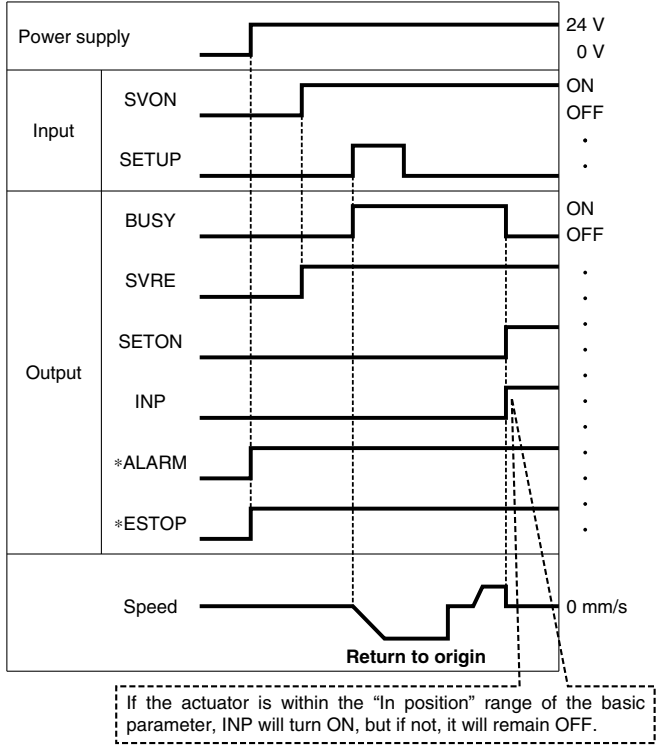

Positioning Operation

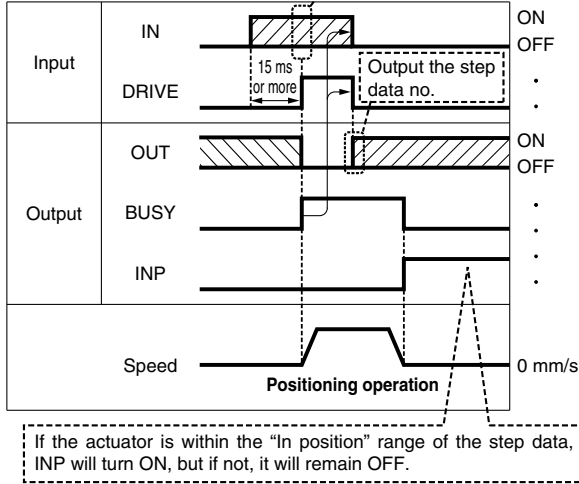

* "OUT" is output when "DRIVE" is changed from ON to OFF.
Refer to the operation manual for details on the controller for the LEM series.
(When power supply is applied, "DRIVE" or "RESET" is turned ON or *ESTOP" is turned OFF, all of the "OUT" outputs are OFF.)

HOLD

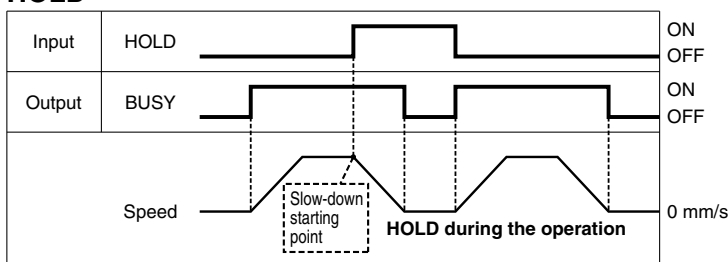

* When the actuator is within the "In position" range in the pushing operation, it does not stop even if HOLD signal is input.

Pushing Operation

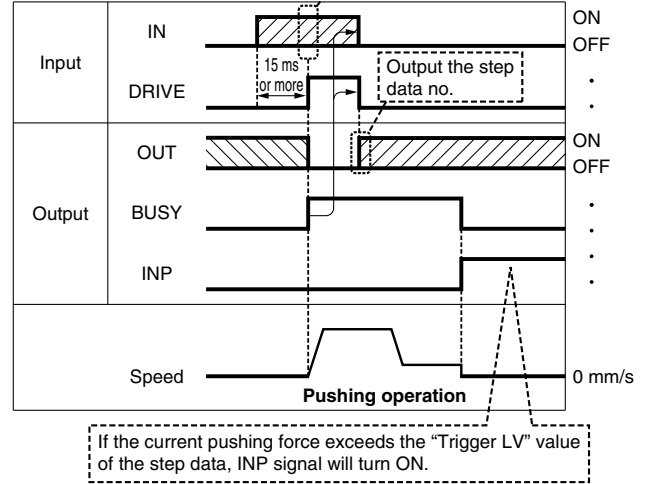

Reset

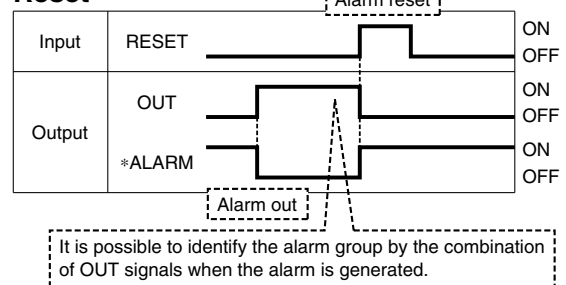

* *ALARM" is expressed as a negative-logic circuit.

Model Selection

LEG Series

Auto Switch

JXC5H/6H Series

JXCEH/9H/PH Series

Specific Product Precautions

JXC5H/6H Series

Options

■ Communication cable for controller setting

① Communication cable JXC-W2A-C

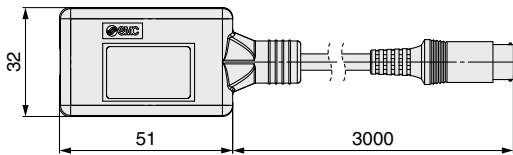

* It can be connected to the controller directly.

② USB cable LEC-W2-U

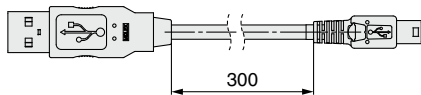

③ Controller setting kit JXC-W2A

A set which includes a communication cable (JXC-W2A-C) and a USB cable (LEC-W2-U)

<Controller setting software/USB driver>

- Controller setting software
 - USB driver (For JXC-W2A-C)
- Download from SMC's website:
<https://www.smcworld.com>

Hardware Requirements

OS	Windows®7, Windows®8.1, Windows®10, Windows®11
Communication interface	USB 1.1 or USB 2.0 ports
Display	1024 x 768 or more

* Windows®7, Windows®8.1, Windows®10, and Windows®11 are registered trademarks of Microsoft Corporation in the United States.

■ Conversion cable P5062-5 (Cable length: 300 mm)

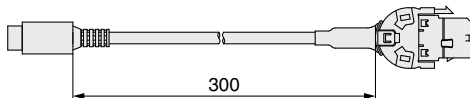

* To connect the teaching box (LEC-T1-3□J□G□) or controller setting kit (LEC-W2□) to the controller, a conversion cable is required.

■ I/O cable

LEC-CN5-1

Cable length (L) [m]	
1	1.5
3	3
5	5

* Conductor size: AWG28

Weight

Product no.	Weight [g]
LEC-CN5-1	170
LEC-CN5-3	320
LEC-CN5-5	520

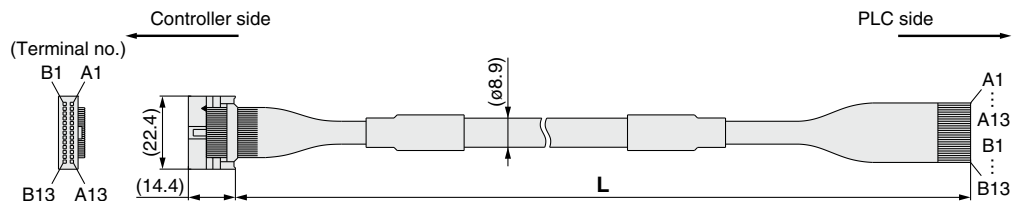

Connector pin no.	Insulation color	Dot mark	Dot color
A1	Light brown	■	Black
A2	Light brown	■	Red
A3	Yellow	■	Black
A4	Yellow	■	Red
A5	Light green	■	Black
A6	Light green	■	Red
A7	Gray	■	Black
A8	Gray	■	Red
A9	White	■	Black
A10	White	■	Red
A11	Light brown	■ ■	Black
A12	Light brown	■ ■	Red
A13	Yellow	■ ■	Black

Connector pin no.	Insulation color	Dot mark	Dot color
B1	Yellow	■ ■	Red
B2	Light green	■ ■	Black
B3	Light green	■ ■	Red
B4	Gray	■ ■	Black
B5	Gray	■ ■	Red
B6	White	■ ■	Black
B7	White	■ ■	Red
B8	Light brown	■ ■ ■	Black
B9	Light brown	■ ■ ■	Red
B10	Yellow	■ ■ ■	Black
B11	Yellow	■ ■ ■	Red
B12	Light green	■ ■ ■	Black
B13	Light green	■ ■ ■	Red
—			Shield

■ Power supply plug JXC-CPW

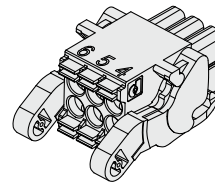

* The power supply plug is an accessory.
 <Applicable cable size> AWG20 (0.5 mm²), cover diameter 2.0 mm or less

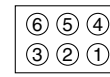

- ① C24V
- ② M24V
- ③ EMG
- ④ 0V
- ⑤ N.C.
- ⑥ LK RLS

Power supply plug

Terminal name	Function	Details
0V	Common supply (-)	The M24V terminal, C24V terminal, EMG terminal, and LK RLS terminal are common (-).
M24V	Motor power supply (+)	Motor power supply (+) of the controller
C24V	Control power supply (+)	Control power supply (+) of the controller
EMG	Stop (+)	Connection terminal of the external stop circuit
LK RLS	Lock release (+)	Connection terminal of the lock release switch

■ Teaching box

LEC-T1-3□J□G□

Teaching box

Cable length [m]
 3 3

Initial language

J	Japanese
E	English

* The displayed language can be changed to English or Japanese.



Enable switch

Nil	None
S	Equipped with enable switch

* Interlock switch for jog and test function

Stop switch

G	Equipped with stop switch
---	---------------------------

Specifications

Item	Description
Switch	Stop switch, Enable switch (Option)
Cable length [m]	3
Enclosure	IP64 (Except connector)
Operating temperature range [°C]	5 to 50
Operating humidity range [%RH]	90 or less (No condensation)
Weight [g]	350 (Except cable)

High Performance Step Motor Controller

JXCEH/9H/PH Series



— For details, refer to page 43 and onward. —

Model Selection

LEG Series

Auto Switch

JXC5H/6H Series

JXCEH/9H/PH Series

Specific Product Precautions

How to Order

⚠ Caution

[CE/UKCA-compliant products]

- ① EMC compliance was tested by combining the electric actuator LE series and the JXCEH/PH series.
The EMC depends on the configuration of the customer's control panel and the relationship with other electrical equipment and wiring. Therefore, compliance with the EMC directive cannot be certified for SMC components incorporated into the customer's equipment under actual operating conditions. As a result, it is necessary for the customer to verify compliance with the EMC directive for the machinery and equipment as a whole.
- ② For the JXCEH/PH series (step motor controller), EMC compliance was tested by installing a noise filter set (LEC-NFA). Refer to page 40 for the noise filter set. Refer to the JXCEH/PH Operation Manual for installation.

JXC PH 7 - []

Communication protocol

E	EtherCAT
9	EtherNet/IP™
P	PROFINET

High performance

Mounting

7	Screw mounting
8*1	DIN rail

*1 The DIN rail is not included. It must be ordered separately. (Refer to page 40.)



EtherCAT EtherNet/IP PROFINET

Actuator part number

Without cable specifications and actuator options
Example: Enter "LEG32MDGB-30" for the LEG32MDGB-30C-R1C□1□□.

BC Blank controller*1

*1 Requires dedicated software (JXC-BCW)

The controller is sold as single unit after the compatible actuator is set.

Confirm that the combination of the controller and actuator is correct.

<Check the following before use.>

- ① Check the actuator label for the model number. This number should match that of the controller.
- ② Check that the Parallel I/O configuration matches (NPN or PNP).

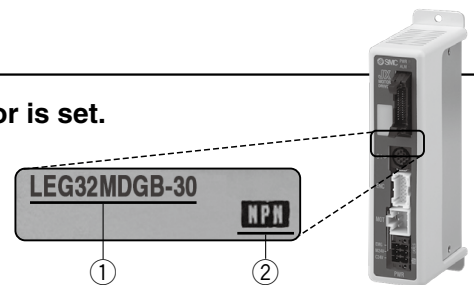

* Refer to the "Operation Manual" for using the products. Please download it via our website: <https://www.smcworld.com>

Precautions for blank controllers (JXC□H□-BC)

A blank controller is a controller to which the customer can write the data of the actuator it is to be combined and used with. Use the dedicated software (JXC-BCW) for data writing.

- Please download the dedicated software (JXC-BCW) via our website.
- Order the communication cable for controller setting (JXC-W2A-C) and USB cable (LEC-W2-U) separately to use this software.

SMC website: <https://www.smcworld.com>

JXCEH/9H/PH Series

Specifications

Model		JXCEH	JXC9H	JXCPH
Network		EtherCAT	EtherNet/IP™	PROFINET
Compatible motor		Step motor (Servo/24 VDC)		
Power supply		Power voltage: 24 VDC ±10%		
Current consumption (Controller)		200 mA or less	200 mA or less	200 mA or less
Compatible encoder		Battery-less absolute		
Communication specifications	Applicable system	Protocol	EtherCAT*2	PROFINET*2
		Version*1	Conformance Test Record V.1.2.6	Specification Version 2.32
	Communication speed	100 Mbps*2	10/100 Mbps*2 (Automatic negotiation)	100 Mbps*2
	Configuration file*3	ESI file	EDS file	GSDML file
	I/O occupation area	Input 20 bytes Output 36 bytes	Input 36 bytes Output 36 bytes	Input 36 bytes Output 36 bytes
	Terminating resistor	Not included		
Memory		EEPROM		
LED indicator		PWR, RUN, ALM, ERR	PWR, ALM, MS, NS	PWR, ALM, SF, BF
Cable length [m]		Actuator cable: 20 or less		
Cooling system		Natural air cooling		
Operating temperature range [°C]		0 to 40 (No freezing)*4		
Operating humidity range [%RH]		90 or less (No condensation)		
Enclosure		IP30 (Excludes the connector)		
Insulation resistance [MΩ]		Between all external terminals and the case: 50 (500 VDC)		
Weight [g]		260 (Screw mounting) 280 (DIN rail mounting)	250 (Screw mounting) 270 (DIN rail mounting)	260 (Screw mounting) 280 (DIN rail mounting)

*1 Please note that versions are subject to change.

*2 Use a shielded communication cable with CAT5 or higher for the PROFINET, EtherNet/IP™, and EtherCAT.

*3 The files can be downloaded from the SMC website.

*4 The operating temperature range for both controller version 1 products and controller version 2 products is 0 to 40°C.

■Trademark

EtherNet/IP® is a registered trademark of ODVA, Inc.

EtherCAT® is registered trademark and patented technology, licensed by Beckhoff Automation GmbH, Germany.

Example of Operation Command

In addition to the step data input of 64 points max. in each communication protocol, the changing of each parameter can be performed in real time via numerical data defined operation.

* Numerical values other than "Moving force," "Area 1," and "Area 2" can be used to perform operation under numerical instructions from JXCL1.

<Application example> Movement between 2 points

No.	Movement mode	Speed	Position	Acceleration	Deceleration	Pushing force	Trigger LV	Pushing speed	Moving force	Area 1	Area 2	In position
0	1: Absolute	100	10	3000	3000	0	0	0	100	0	0	0.50
1	1: Absolute	100	100	3000	3000	0	0	0	100	0	0	0.50

<Step no. defined operation>

Sequence 1: Servo ON instruction

Sequence 2: Instruction to return to origin

Sequence 3: Specify step data No. 0 to input the DRIVE signal.

Sequence 4: Specify step data No. 1 after the DRIVE signal has been temporarily turned OFF to input the DRIVE signal.

<Numerical data defined operation>

Sequence 1: Servo ON instruction

Sequence 2: Instruction to return to origin

Sequence 3: Specify step data No. 0 and turn ON the input instruction flag (position). Input 10 in the target position. Subsequently the start flag turns ON.

Sequence 4: Turn ON step data No. 0 and the input instruction flag (position) to change the target position to 100 while the start flag is ON.

The same operation can be performed with any operation command.

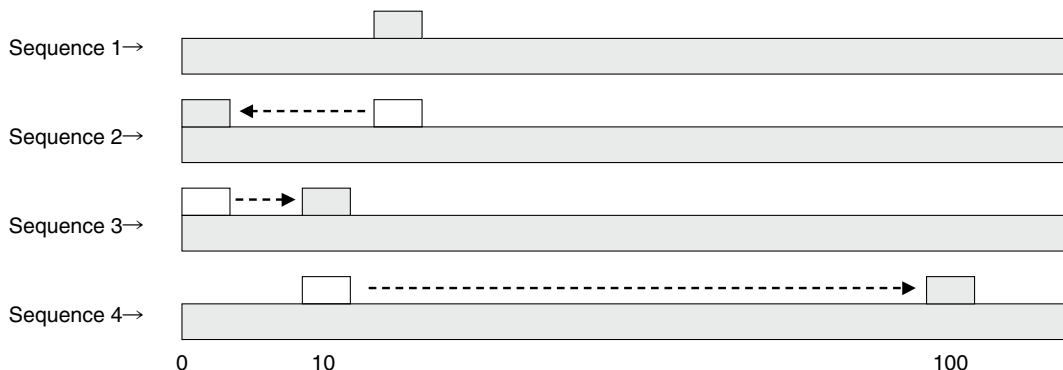

Dimensions

JXCEH

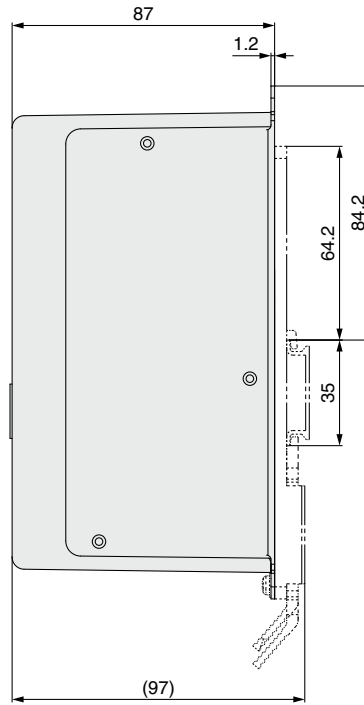
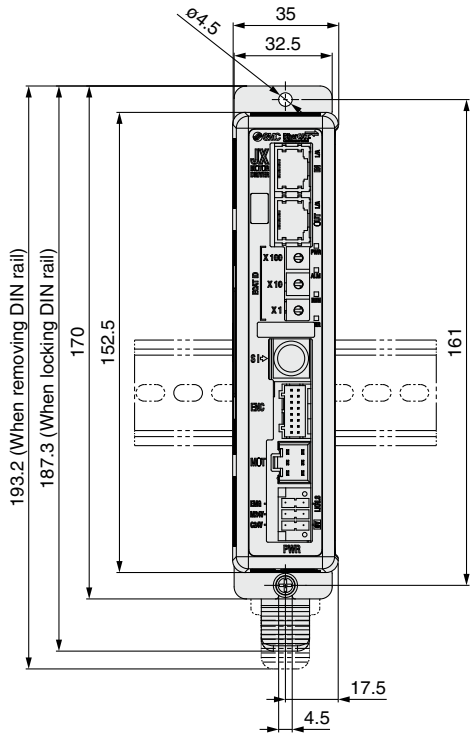

JXC9H

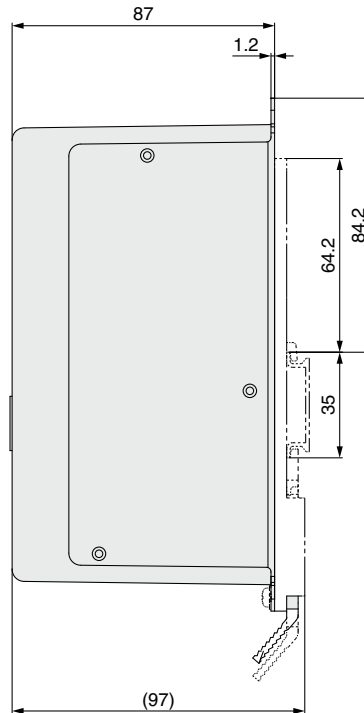
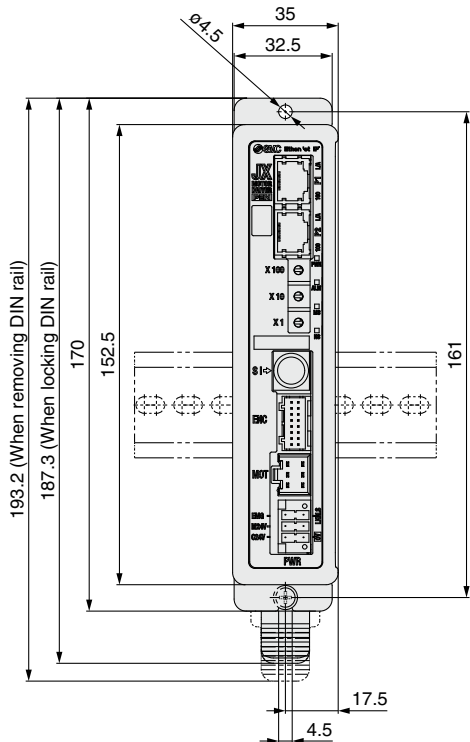

Model Selection

LEG Series

Auto Switch

JXC5H/6H Series

JXCEH/9H/PH Series

Specific Product Precautions

JXCEH/9H/PH Series

Dimensions

JXCPH

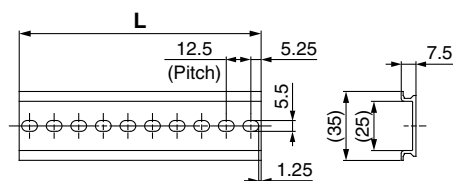
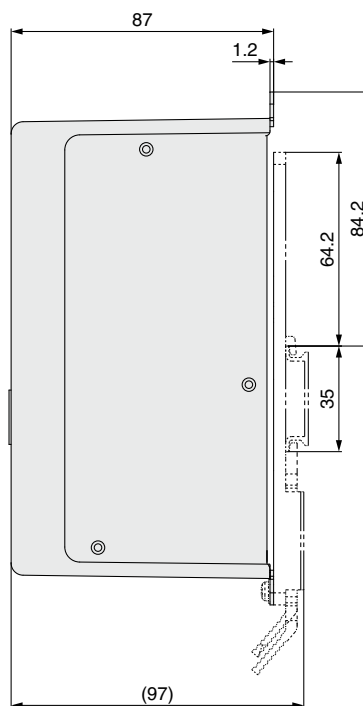
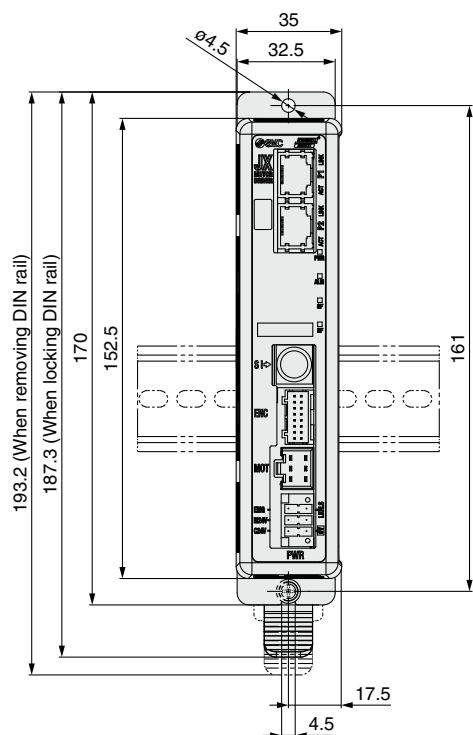

L Dimensions [mm]

No.	1	2	3	4	5	6	7	8	9	10	11	12	13	14	15	16	17	18	19	20
L	23	35.5	48	60.5	73	85.5	98	110.5	123	135.5	148	160.5	173	185.5	198	210.5	223	235.5	248	260.5
No.	21	22	23	24	25	26	27	28	29	30	31	32	33	34	35	36	37	38	39	40
L	273	285.5	298	310.5	323	335.5	348	360.5	373	385.5	398	410.5	423	435.5	448	460.5	473	485.5	498	510.5

Options

■ Communication cable for controller setting

① Communication cable JXC-W2A-C

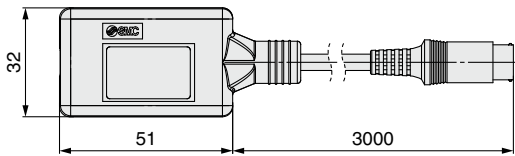

* It can be connected to the controller directly.

② USB cable LEC-W2-U

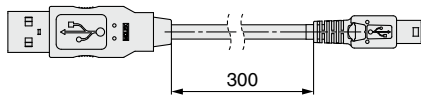

③ Controller setting kit JXC-W2A

A set which includes a communication cable (JXC-W2A-C) and a USB cable (LEC-W2-U)

<Controller setting software/USB driver>

- Controller setting software
- USB driver (For JXC-W2A-C)

Download from SMC's website: <https://www.smcworld.com>

Hardware Requirements

OS	Windows®7, Windows®8.1, Windows®10, Windows®11
Communication interface	USB 1.1 or USB 2.0 ports
Display	1024 x 768 or more

* Windows®7, Windows®8.1, Windows®10, and Windows®11 are registered trademarks of Microsoft Corporation in the United States.

■ DIN rail mounting adapter LEC-3-D0

* With 2 mounting screws

This should be used when the DIN rail mounting adapter is mounted onto a screw mounting type controller afterward.

■ DIN rail AXT100-DR-□

* For □, enter a number from the No. line in the table on page 39. Refer to the dimension drawings on pages 38 and 39 for the mounting dimensions.

■ Teaching box

LEC-T1-3 J G

Teaching box

Cable length [m]
3 3

Initial language

J	Japanese
E	English

* The displayed language can be changed to English or Japanese.

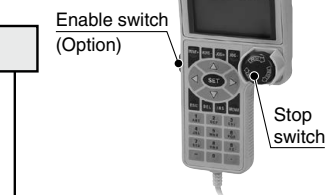

Enable switch

Nil	None
S	Equipped with enable switch

* Interlock switch for jog and test function

Stop switch

G	Equipped with stop switch
----------	---------------------------

Specifications

Item	Description
Switch	Stop switch, Enable switch (Option)
Cable length [m]	3
Enclosure	IP64 (Except connector)
Operating temperature range [°C]	5 to 50
Operating humidity range [%RH]	90 or less (No condensation)
Weight [g]	350 (Except cable)

■ Power supply plug JXC-CPW

* The power supply plug is an accessory.

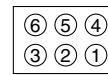
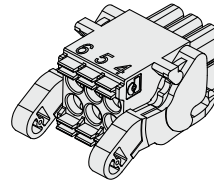

- | | |
|--------|----------|
| ① C24V | ④ 0V |
| ② M24V | ⑤ N.C. |
| ③ EMG | ⑥ LK RLS |

Power supply plug

Terminal name	Function	Details
0V	Common supply (-)	The M24V terminal, C24V terminal, EMG terminal, and LK RLS terminal are common (-).
M24V	Motor power supply (+)	Motor power supply (+) of the controller
C24V	Control power supply (+)	Control power supply (+) of the controller
EMG	Stop (+)	Connection terminal of the external stop circuit
LK RLS	Lock release (+)	Connection terminal of the lock release switch

■ Conversion cable P5062-5 (Cable length: 300 mm)

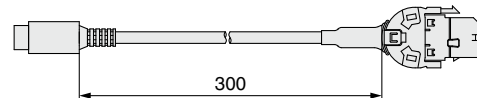

* To connect the teaching box (LEC-T1-3□G□) or controller setting kit (LEC-W2) to the controller, a conversion cable is required.

■ Noise filter set

LEC-NFA

Contents of the set: 2 noise filters

(Manufactured by WURTH ELEKTRONIK: 74271222)

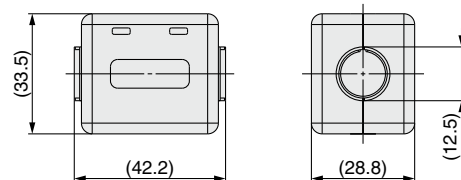

* Refer to the JXCEH/PH series Operation Manual for installation.

Model Selection

LEG Series

Auto Switch

JXC5H/6H Series

JXCEH/9H/PH Series

Specific Product Precautions

JXC5H/6H Series JXCEH/9H/PH Series Actuator Cable (Option)

[Robotic cable for battery-less absolute (Step motor 24 VDC)]

LE-CE-1

Cable length (L) [m]

1	1.5
3	3
5	5
8	8*1
A	10*1
B	15*1
C	20*1

*1 Produced upon receipt of order

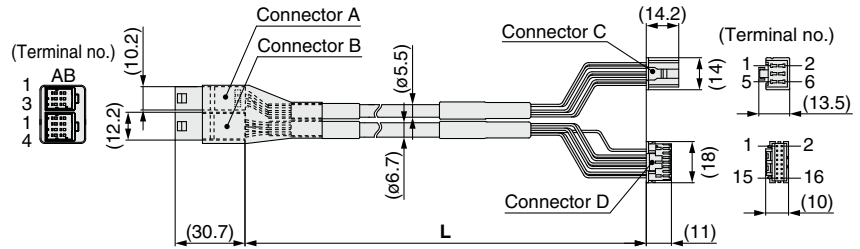

Weight

Product no.	Weight [g]	Note
LE-CE-1	190	Robotic cable
LE-CE-3	360	
LE-CE-5	570	
LE-CE-8	900	
LE-CE-A	1120	
LE-CE-B	1680	
LE-CE-C	2210	

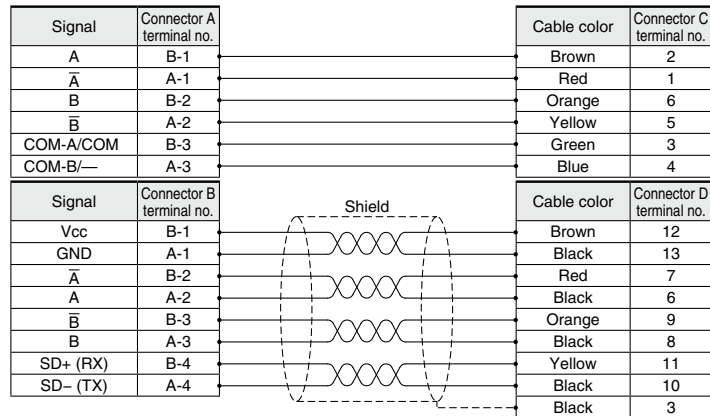

[Robotic cable with lock for battery-less absolute (Step motor 24 VDC)]

LE-CE-1-B

Cable length (L) [m]

1	1.5
3	3
5	5
8	8*1
A	10*1
B	15*1
C	20*1

*1 Produced upon receipt of order

With lock and sensor

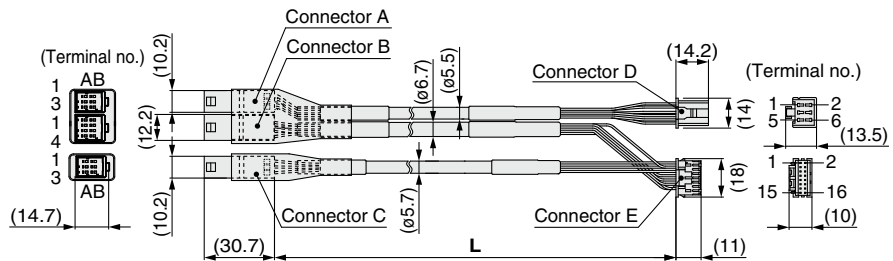

Weight

Product no.	Weight [g]	Note
LE-CE-1-B	240	Robotic cable
LE-CE-3-B	460	
LE-CE-5-B	740	
LE-CE-8-B	1170	
LE-CE-A-B	1460	
LE-CE-B-B	2120	
LE-CE-C-B	2890	

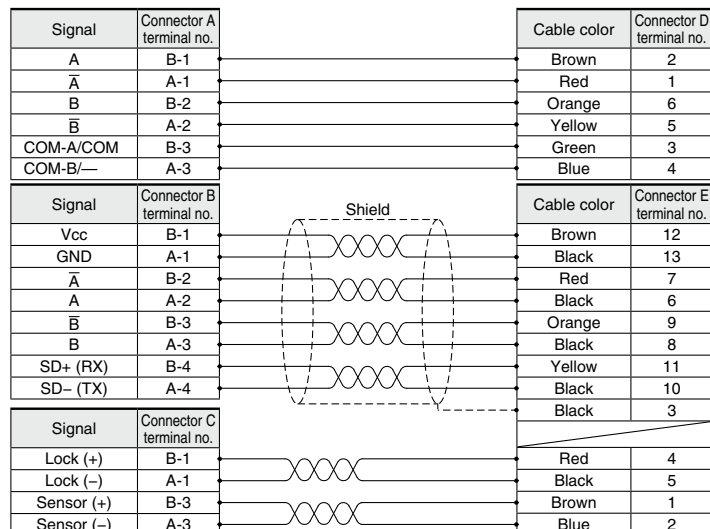



JXC□1/JXC□F/JXC□H Series

Precautions Relating to Differences in Controller Versions

As the controller version of the JXC series differs, the internal parameters are not compatible.

- If using the JXC□1□-BC, please use the latest version of the JXC-BCW (parameter writing tool).
- There are currently 3 versions available: version 1 products (V1.□ or S1.□), version 2 products (V2.□ or S2.□), and version 3 products (V3.□ or S3.□). Keep in mind that in order to write a backup file (.bcp) to another controller with the JXC-BCW, it needs to be the same version as the controller that created the file. (For example, a backup file created by a version 1 product can only be written to another version 1 product, and so on.)

Identifying Version Symbols

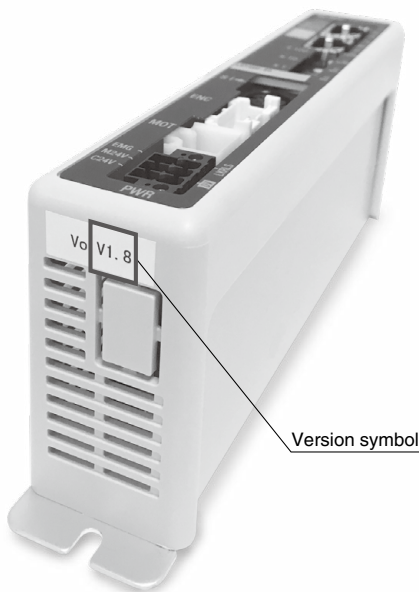

JXC□□ Series Version V3.□ or S3.□ Products

XR V3.0

Applicable models
JXC91 Series

XR S3.0 T1.0

Applicable models
JXC51 Series
JXC61 Series
JXCE□ Series
JXCP1 Series
JXCD1 Series
JXCL□ Series
JXCM1 Series

JXC□□ Series Version V2.□ or S2.□ Products

WP V2.1

Applicable models
JXC91 Series

WP S2.2 T1.1

Applicable models
JXCE□ Series
JXCP1 Series
JXCD1 Series
JXCL□ Series

JXC□□ Series Version V1.□ or S1.□ Products

XR V1.0

Applicable models
JXC91 Series

XR S1.0 T1.0

Applicable models
JXCE□ Series
JXCP□ Series
JXCD1 Series
JXCL□ Series
JXC5H Series
JXC6H Series

Model Selection

LEG Series

Auto Switch

JXC5H/6H Series

JXCEH/9H/PH Series

Specific Product Precautions

JXC□H Series

Blank Controller Versions and Applicable Battery-less Absolute Type Electric Actuator Sizes

- The applicable battery-less absolute type electric actuator size range differs depending on the controller version.
Be sure to confirm the controller version before using a blank controller.

Blank Controller Versions/Applicable Electric Actuator Sizes (JXC□H Series)

Blank controller		Applicable electric actuator size				
Series	Controller version	LEFS□G	LEKF□G	LEY□G	LEG	LESYH□G
JXC9H series JXCEH series JXCPH series	All versions	16, 25, 32, 40	25, 32, 40	16, 25, 40	25, 32, 40	8, 16, 25
	Version 1.0	25, 32, 40		25, 40		16, 25
JXC5H/6H series	Version 1.1 or higher	16, 25, 32, 40		16, 25, 40		8, 16, 25



Battery-less Absolute Encoder Type Specific Product Precautions

Be sure to read this before handling the products. Refer to the back cover for safety instructions. For electric actuator precautions, refer to the “Handling Precautions for SMC Products” and the “Operation Manual” on the SMC website: <https://www.smcworld.com>

Handling

⚠ Caution

1. Absolute encoder ID mismatch error at the first connection

In the following cases, an “ID mismatch error” alarm occurs after the power is turned ON. Perform a return to origin operation after resetting the alarm before use.

- When an electric actuator is connected and the power is turned ON for the first time after purchase*1
- When the actuator or motor is replaced
- When the controller is replaced

*1 If you have purchased an electric actuator and controller with the set part number, the pairing may have already been completed and the alarm may not be generated.

“ID mismatch error”

Operation is enabled by matching the encoder ID on the electric actuator side with the ID registered in the controller. This alarm occurs when the encoder ID is different from the registered contents of the controller. By resetting this alarm, the encoder ID is registered (paired) to the controller again.

When a controller is changed after pairing is completed				
	Encoder ID no. (* Numbers below are examples.)			
Actuator	17623	17623	17623	17623
Controller	17623	17699	17699	17623
ID mismatch error occurred?	No	Yes	Error reset ⇒ No	

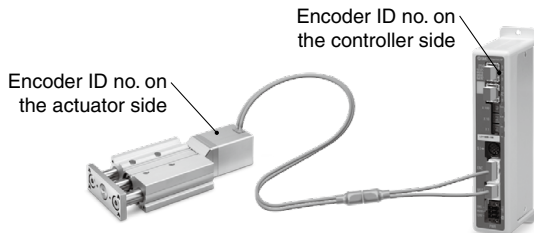

The ID number is automatically checked when the control power supply is turned ON. An error is output if the ID number does not match.

2. In environments where strong magnetic fields are present, use may be limited.

A magnetic sensor is used in the encoder. Therefore, if the actuator motor is used in an environment where strong magnetic fields are present, malfunction or failure may occur. Do not expose the actuator motor to magnetic fields with a magnetic flux density of 1 mT or more.

When installing an electric actuator and an air cylinder with an auto switch (e.g. CDQ2 series) or multiple electric actuators side by side, maintain a space of 40 mm or more around the motor. Refer to the construction drawing of the actuator motor.

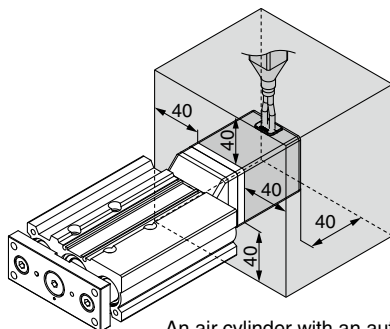

An air cylinder with an auto switch cannot be installed in the shaded area.

• When lining up actuators

SMC actuators can be used with their motors adjacent to each other. However, for actuators with a built-in auto switch magnet, maintain a space of 40 mm or more between the motors and the position where the magnet passes.

For the LEF series, the magnet is in the middle of the table, and for the LEY series, the magnet is in the piston portion. (For other actuators, refer to the construction drawings in the catalog.)

○ Can be used with their motors adjacent to each other

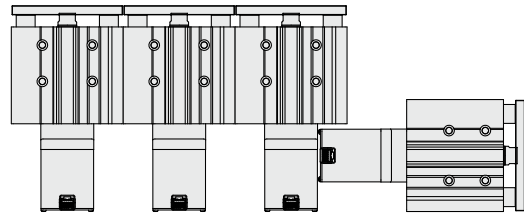
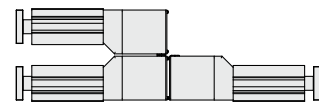

✗ Do not allow the motors to be in close proximity to the position where the magnet passes.

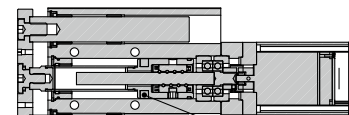
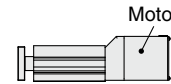

Motor
Electric actuator built-in magnet portion screw nut

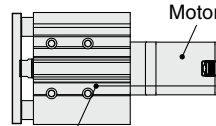

Motor
Electric actuator built-in magnet portion screw nut
Maintain a space of 40 mm or more.

3. The connector size of the motor cable is different from that of the electric actuator with an incremental encoder.

The motor cable connector of an electric actuator with a battery-less absolute encoder is different from that of an electric actuator with an incremental encoder. As the connector cover dimensions are different, take the dimensions below into consideration during the design process.

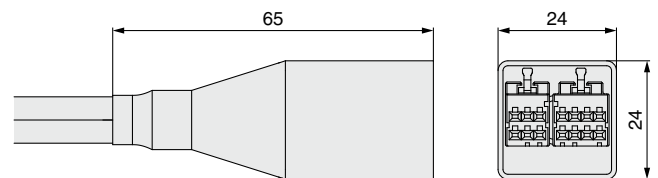

Battery-less absolute encoder connector cover dimensions

CE/UKCA/UL-compliance List

* For CE, UKCA, and UL-compliant products, refer to the tables below and the following pages.

■ Controllers "○": Compliant "x": Not compliant

As of February 2022

Compatible motor	Series	CE UKCA		cULus		Compatible motor	Series	CE UKCA		cULus LISTED		
		Compliance	Certification No. (File No.)	Compliance	Certification No. (File No.)			Compliance	Certification No. (File No.)	Compliance	Certification No. (File No.)	
Step motor (Servo/24 VDC)	JXCE1	○	○	○	E480340	AC servo motor	LECSA	○	○	○	E466261	
	JXC91	○	○	○	E480340		LECSB-T	○	○	○	E466261	
	JXCP1	○	○	○	E480340		LECSA-T	○	○	○	E466261	
	JXCD1	○	○	○	E480340		LECSN-T	○	○*1	○	E466261	
	JXCL1	○	○	○	E480340		LECSS-T	○	○	○	E466261	
	JXCM1	○	○	○	E480340		LECYM	○	x	○	—	
	LECP1	○	○	○	E339743		LECYU	○	x	○	—	
	LECP2	○	○	○	E339743							
	LECPA	○	○	○	E339743							
	JXC51/61	○	○	○	E480340							
Battery-less absolute (Step motor 24 VDC)	JXCE1	○	○	○	E480340							
	JXC91	○	○	○	E480340							
	JXCP1	○	○	○	E480340							
	JXCD1	○	○	○	E480340							
	JXCL1	○	○	○	E480340							
	JXCM1	○	○	○	E480340							
High performance (Step motor 24 VDC)	JXC5H/6H	○	○	○	E480340							
	JXCEH	○	○	○	E480340							
	JXC9H	○	○	○	E480340							
Servo motor (24 VDC)	JXCPH	○	○	○	E480340							
	LECA6	○	○	○	E339743							
Step motor (Servo/24 VDC)	JXC73	○	x	○	—							
	JXC83	○	x	○	—							
	JXC93	○	x	○	—							
	JXC92	○	x	○	—							

*1 Only the "Without network card" option is UL compliant.

■ Actuators "○": Compliant "x": Not compliant

As of February 2022

Compatible motor	Series	CE UKCA		cULus		Compatible motor	Series	CE UKCA		cULus	
		Compliance	Certification No. (File No.)	Compliance	Certification No. (File No.)			Compliance	Certification No. (File No.)	Compliance	Certification No. (File No.)
Step motor (Servo/24 VDC)	LEFS	○	x	○	—	Servo motor (24 VDC)	LEFS	○	x	○	—
	11-LEFS	○	x	○	—		11-LEFS	○	x	○	—
	25A-LEFS	○	x	○	—		25A-LEFS	○	x	○	—
	LEFB	○	x	○	—		LEFB	○	x	○	—
	LEL	○	x	○	—		LEY	○	x	○	—
	LEM	○	x	○	—		LEY-X5/X7	○	x	○	—
	LEY	○	x	○	—		LEYG	○	x	○	—
	25A-LEY	○	x	○	—		LES	○	x	○	—
	LEY-X5/X7	○	x	○	—		LESH	○	x	○	—
	LEYG	○	x	○	—		LEFS	○	x	○	—
	LES	○	x	○	—	11-LEFS	○	x	○	—	
	LESH	○	x	○	—	25A-LEFS	○	x	○	—	
	LEPY	○	x	○	—	LEFB	○	x	○	—	
	LEPS	○	x	○	—	LEJS	○	x	○	—	
	LER	○	x	○	—	11-LEJS	○	x	○	—	
	LEHZ	○	x	○	—	25A-LEJS	○	x	○	—	
	LEHZJ	○	x	○	—	LEJB	○	x	○	—	
	LEHF	○	x	○	—	LEY25/32/63	○	x	○	—	
	LEHS	○	x	○	—	LEY100	○	x	○	—	
	Battery-less absolute (Step motor 24 VDC)	LEFS	○	x	○	—	LEYG	○	x	○	—
LEFB		○	x	○	—	LESYH	○	x	○	—	
LEKFS		○	x	○	—						
LEY		○	x	○	—						
LEY-X8		○	x	○	—						
LEYG		○	x	○	—						
LES		○	x	○	—						
LESH		○	x	○	—						
LESYH		○	x	○	—						
LER		○	x	○	—						
LEHF	○	x	○	—							
High performance (Step motor 24 VDC)	LEFS	○	x	○	—						
High performance battery-less absolute (Step motor 24 VDC)	LEFS□G	○	x	○	—						
	LEG	○	x	○	—						

* Actuators ordered as single units are not UL compliant.

CE/UKCA/UL-compliance List

■ Actuators (When ordered with a controller) “○”: Compliant “x”: Not compliant “—”: Not applicable As of February 2022

Compatible motor	Series	JXC51/61			JXCE1			JXC91			JXCP1			JXCD1		
		CE UK CA	cULus		CE UK CA	cULus		CE UK CA	cULus		CE UK CA	cULus		CE UK CA	cULus	
			Compliance	Certification No. (File No.)		Compliance	Certification No. (File No.)		Compliance	Certification No. (File No.)		Compliance	Certification No. (File No.)		Compliance	Certification No. (File No.)
Battery-less absolute (Step motor 24 VDC)	LEFS	○	x	—	○	x	—	○	x	—	○	x	—	○	x	—
	LEFB	○	x	—	○	x	—	○	x	—	○	x	—	○	x	—
	LEKFS	○	x	—	○	x	—	○	x	—	○	x	—	○	x	—
	LEY	○	x	—	○	x	—	○	x	—	○	x	—	○	x	—
	LEY-X8	○	x	—	○	x	—	○	x	—	○	x	—	○	x	—
	LEYG	○	x	—	○	x	—	○	x	—	○	x	—	○	x	—
	LES	○	x	—	○	x	—	○	x	—	○	x	—	○	x	—
	LESH	○	x	—	○	x	—	○	x	—	○	x	—	○	x	—
	LESYH	○	x	—	○	x	—	○	x	—	○	x	—	○	x	—
	LER	○	x	—	○	x	—	○	x	—	○	x	—	○	x	—
LEHF	○	x	—	○	x	—	○	x	—	○	x	—	○	x	—	

Compatible motor	Series	JXCL1			JXCM1		
		CE UK CA	cULus		CE UK CA	cULus	
			Compliance	Certification No. (File No.)		Compliance	Certification No. (File No.)
Battery-less absolute (Step motor 24 VDC)	LEFS	○	x	—	○	x	—
	LEFB	○	x	—	○	x	—
	LEKFS	○	x	—	○	x	—
	LEY	○	x	—	○	x	—
	LEY-X8	○	x	—	○	x	—
	LEYG	○	x	—	○	x	—
	LES	○	x	—	○	x	—
	LESH	○	x	—	○	x	—
	LESYH	○	x	—	○	x	—
	LER	○	x	—	○	x	—
LEHF	○	x	—	○	x	—	

CE/UKCA/UL-compliance List

■ Actuators (When ordered with a controller) "○": Compliant "x": Not compliant "—": Not applicable As of February 2022

Compatible motor	Series	JXC5H/6H			JXCEH			JXC9H			JXCPH		
		CE UK CA	cRU ^{us}		CE UK CA	cRU ^{us}		CE UK CA	cRU ^{us}		CE UK CA	cRU ^{us}	
			Compliance	Certification No. (File No.)		Compliance	Certification No. (File No.)		Compliance	Certification No. (File No.)		Compliance	Certification No. (File No.)
High performance (Step motor 24 VDC)	LEF	○	○	E339743	○	○	E339743	○	○	E339743	○	○	E339743
High performance battery-less absolute (Step motor 24 VDC)	LEFS□G	○	x	—	○	x	—	○	x	—	○	x	—
	LEG	○	x	—	○	x	—	○	x	—	○	x	—

Compatible motor	Series	LECA6		
		CE UK CA	cRU ^{us}	
			Compliance	Certification No. (File No.)
Servo motor (24 VDC)	LEFS	○	○	E339743
	11-LEFS	○	○	E339743
	25A-LEFS	○	○	E339743
	LEFB	○	○	E339743
	LEY	○	○	E339743
	LEY-X5/X7	○	x	—
	LEYG	○	○	E339743
	LES	○	○	E339743
	LESH	○	○	E339743

Compatible motor	Series	LECSA*1			LECSB-T*1			LECS-C-T*1			LECSN-T*1			LECSS-T*1		
		CE UK CA	cRU ^{us}		CE UK CA	cRU ^{us}		CE UK CA	cRU ^{us}		CE UK CA	cRU ^{us}		CE UK CA	cRU ^{us}	
			Compliance	Certification No. (File No.)		Compliance	Certification No. (File No.)		Compliance	Certification No. (File No.)		Compliance	Certification No. (File No.)		Compliance	Certification No. (File No.)
AC servo motor	LEFS	○	○	E339743	○	x	—	○	x	—	○	x	—	○	○	E339743
	11-LEFS	○	○	E339743	○	x	—	○	x	—	○	x	—	○	○	E339743
	25A-LEFS	○	○	E339743	○	x	—	○	x	—	○	x	—	○	○	E339743
	LEKFS	○	x	—	○	x	—	○	x	—	○	x	—	○	x	—
	LEFB	○	○	E339743	○	x	—	○	x	—	○	x	—	○	○	E339743
	LEJS	○	○	E339743	○	x	—	○	x	—	○	x	—	○	○	E339743
	11-LEJS	○	○	E339743	○	x	—	○	x	—	○	x	—	○	○	E339743
	25A-LEJS	○	○	E339743	○	x	—	○	x	—	○	x	—	○	○	E339743
	LEJB	○	○	E339743	○	x	—	○	x	—	○	x	—	○	○	E339743
	LEY25/32/63	○	○	E339743	○	x	—	○	x	—	○	x	—	○	○	E339743
	LEY100	—	—	—	○	x	—	○	x	—	○	x	—	○	x	—
	LEYG	○	○	E339743	○	x	—	○	x	—	○	x	—	○	○	E339743
	LESYH	○	x	—	○	x	—	○	x	—	○	x	—	○	x	—

Compatible motor	Series	LECYM-V			LECYU-V		
		CE UK CA	cRU ^{us}		CE UK CA	cRU ^{us}	
			Compliance	Certification No. (File No.)		Compliance	Certification No. (File No.)
AC servo motor	LEFS	○	x	—	○	x	—
	11-LEFS	○	x	—	○	x	—
	25A-LEFS	○	x	—	○	x	—
	LEFB	○	x	—	○	x	—
	LEJS	○	x	—	○	x	—
	11-LEJS	○	x	—	○	x	—
	25A-LEJS	○	x	—	○	x	—
	LEJB	○	x	—	○	x	—
	LEY25/32/63	○	x	—	○	x	—
	LEY100	○	x	—	○	x	—
	LEYG	○	x	—	○	x	—
LESYH	○	x	—	○	x	—	

*1 There is a "UL Listed" mark on the AC servo motor driver body.

Safety Instructions

These safety instructions are intended to prevent hazardous situations and/or equipment damage. These instructions indicate the level of potential hazard with the labels of “**Caution**,” “**Warning**” or “**Danger**.” They are all important notes for safety and must be followed in addition to International Standards (ISO/IEC)*1), and other safety regulations.

 **Caution:** **Caution** indicates a hazard with a low level of risk which, if not avoided, could result in minor or moderate injury.

 **Warning:** **Warning** indicates a hazard with a medium level of risk which, if not avoided, could result in death or serious injury.

 **Danger :** **Danger** indicates a hazard with a high level of risk which, if not avoided, will result in death or serious injury.

*1) ISO 4414: Pneumatic fluid power – General rules relating to systems.
ISO 4413: Hydraulic fluid power – General rules relating to systems.
IEC 60204-1: Safety of machinery – Electrical equipment of machines.
(Part 1: General requirements)
ISO 10218-1: Manipulating industrial robots – Safety.
etc.

Warning

1. The compatibility of the product is the responsibility of the person who designs the equipment or decides its specifications.

Since the product specified here is used under various operating conditions, its compatibility with specific equipment must be decided by the person who designs the equipment or decides its specifications based on necessary analysis and test results. The expected performance and safety assurance of the equipment will be the responsibility of the person who has determined its compatibility with the product. This person should also continuously review all specifications of the product referring to its latest catalog information, with a view to giving due consideration to any possibility of equipment failure when configuring the equipment.

2. Only personnel with appropriate training should operate machinery and equipment.

The product specified here may become unsafe if handled incorrectly. The assembly, operation and maintenance of machines or equipment including our products must be performed by an operator who is appropriately trained and experienced.

3. Do not service or attempt to remove product and machinery/equipment until safety is confirmed.

1. The inspection and maintenance of machinery/equipment should only be performed after measures to prevent falling or runaway of the driven objects have been confirmed.
2. When the product is to be removed, confirm that the safety measures as mentioned above are implemented and the power from any appropriate source is cut, and read and understand the specific product precautions of all relevant products carefully.
3. Before machinery/equipment is restarted, take measures to prevent unexpected operation and malfunction.

4. Contact SMC beforehand and take special consideration of safety measures if the product is to be used in any of the following conditions.

1. Conditions and environments outside of the given specifications, or use outdoors or in a place exposed to direct sunlight.
2. Installation on equipment in conjunction with atomic energy, railways, air navigation, space, shipping, vehicles, military, medical treatment, combustion and recreation, or equipment in contact with food and beverages, emergency stop circuits, clutch and brake circuits in press applications, safety equipment or other applications unsuitable for the standard specifications described in the product catalog.
3. An application which could have negative effects on people, property, or animals requiring special safety analysis.
4. Use in an interlock circuit, which requires the provision of double interlock for possible failure by using a mechanical protective function, and periodical checks to confirm proper operation.

Caution

1. The product is provided for use in manufacturing industries.

The product herein described is basically provided for peaceful use in manufacturing industries.
If considering using the product in other industries, consult SMC beforehand and exchange specifications or a contract if necessary.
If anything is unclear, contact your nearest sales branch.

Limited warranty and Disclaimer/ Compliance Requirements

The product used is subject to the following “Limited warranty and Disclaimer” and “Compliance Requirements”.

Read and accept them before using the product.

Limited warranty and Disclaimer

1. The warranty period of the product is 1 year in service or 1.5 years after the product is delivered, whichever is first.*2)
Also, the product may have specified durability, running distance or replacement parts. Please consult your nearest sales branch.
2. For any failure or damage reported within the warranty period which is clearly our responsibility, a replacement product or necessary parts will be provided.
This limited warranty applies only to our product independently, and not to any other damage incurred due to the failure of the product.
3. Prior to using SMC products, please read and understand the warranty terms and disclaimers noted in the specified catalog for the particular products.

*2) Vacuum pads are excluded from this 1 year warranty.

A vacuum pad is a consumable part, so it is warranted for a year after it is delivered.
Also, even within the warranty period, the wear of a product due to the use of the vacuum pad or failure due to the deterioration of rubber material are not covered by the limited warranty.

Compliance Requirements

1. The use of SMC products with production equipment for the manufacture of weapons of mass destruction (WMD) or any other weapon is strictly prohibited.
2. The exports of SMC products or technology from one country to another are governed by the relevant security laws and regulations of the countries involved in the transaction. Prior to the shipment of a SMC product to another country, assure that all local rules governing that export are known and followed.

Caution

SMC products are not intended for use as instruments for legal metrology.

Measurement instruments that SMC manufactures or sells have not been qualified by type approval tests relevant to the metrology (measurement) laws of each country. Therefore, SMC products cannot be used for business or certification ordained by the metrology (measurement) laws of each country.

Safety Instructions

Be sure to read the “Handling Precautions for SMC Products” (M-E03-3) and “Operation Manual” before use.

SMC Corporation

Akihabara UDX 15F,
4-14-1, Sotokanda, Chiyoda-ku, Tokyo 101-0021, JAPAN
Phone: 03-5207-8249 Fax: 03-5298-5362
<https://www.smcworld.com>
© 2022 SMC Corporation All Rights Reserved

Specifications are subject to change without prior notice and any obligation on the part of the manufacturer.

D-G