

Miniature Rod Type Miniature Slide Table Type *LEPY/LEPS Series*



* For details, refer to page 1343 and onward.



Size: 6, 10

Incremental (Step Motor 24 VDC)

Compact and lightweight

- Maximum pushing force: **50 N**
- Positioning repeatability: ± 0.05 mm
- Can set position, speed and force (64 points)

Rod Type *LEPY Series*

Size: 6, 10 ▶ p. 741

Weight **240 g**

* LEPY6□-25

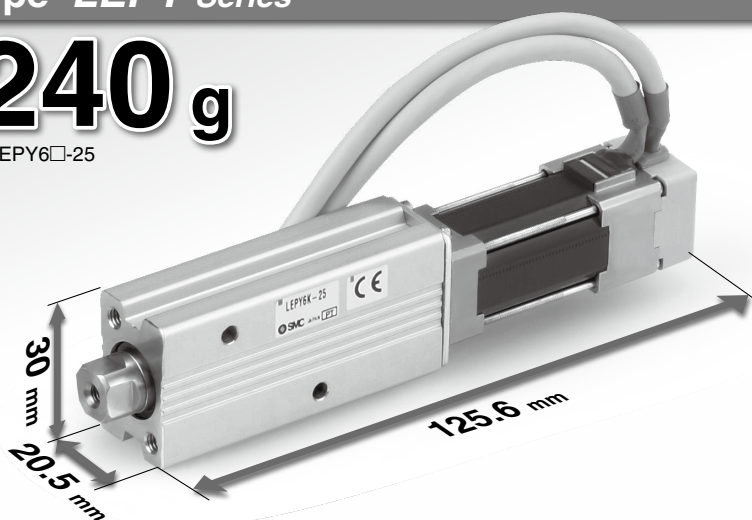

Slide Table Type *LEPS Series*

Size: 6, 10 ▶ p. 751

Weight **290 g**

* LEPS6□-25

Linear guide integrated

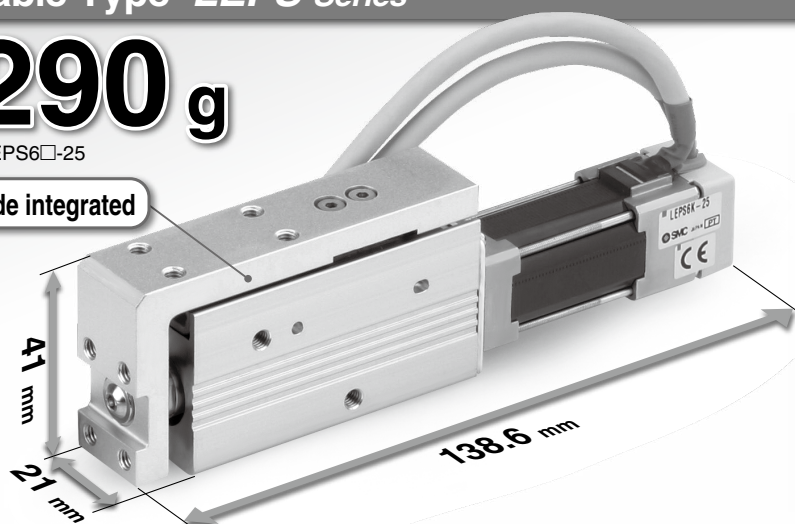

Incremental (Step Motor 24 VDC) **Controllers/Drivers**

▶ p. 994

▶ **Step data input type**

JXC51/61 Series

- 64 positioning points
- Input using controller setting kit or teaching box



▶ **EtherCAT/EtherNet/IP™/PROFINET/DeviceNet®/IO-Link/CC-Link direct input type**

JXC□□/91/P1/D1/L□/M1 Series



▶ **Programless type**

LECP1 Series

- 14 positioning points
- Control panel setting



▶ **Pulse input type**

LECPA Series



Compact and lightweight

Rod Type **LEPY Series**

Weight **240 g**
(LEPY6□-25)

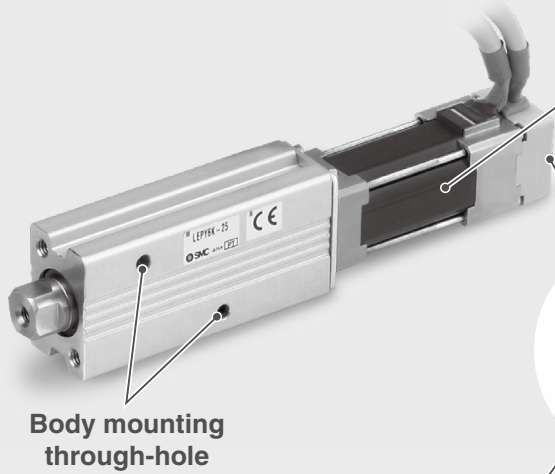

Body mounting through-hole

Motor type can be selected to suit the application.
(Size 10 only)

- High pushing force type/basic type
- Compact and lightweight motor type

Linear guide

Slide Table Type **LEPS Series**

Weight **290 g**
(LEPS6□-25)

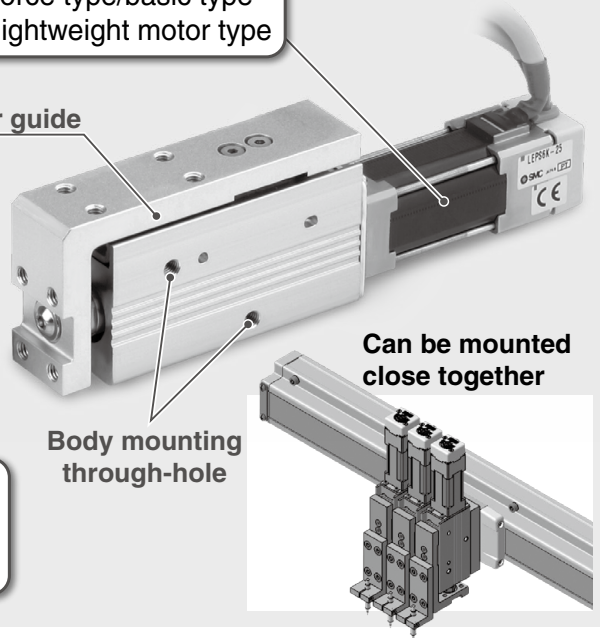

Body mounting through-hole

Can be mounted close together

Manual override screw
For rod/table operation
Adjustment operation is possible when the power is OFF.

Application Examples

For pick and place operations

For delivery

For alignment

For press fitting

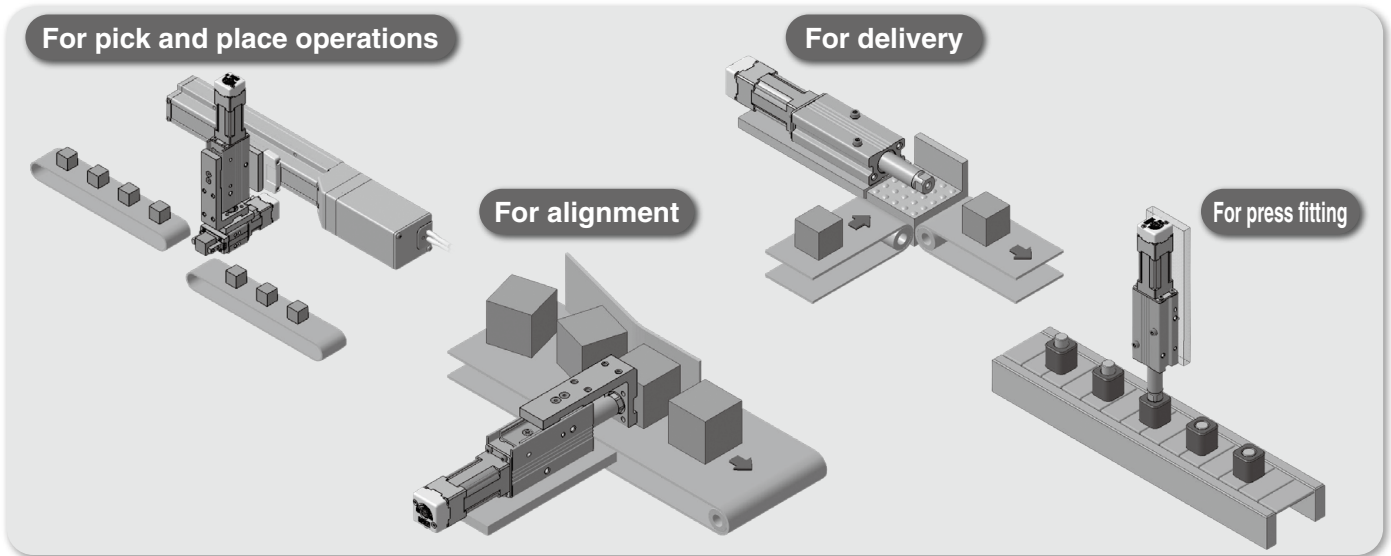

Variations

Type	Size	Screw lead	Pushing force [N]		Max. work load [kg] (Horizontal)		Max. work load [kg] (Vertical)		Max. speed [mm/s] (Horizontal)		Stroke [mm]	Page
			Basic	Compact	Basic	Compact	Basic	Compact	Basic	Compact		
Rod type LEPY Series	6	4	14 to 20	—	2.0	—	0.5	—	150	—	25 50 75	741
		8	7 to 10	—	1.0	—	0.25	—	300	—		
	10	5	25 to 50	24 to 40	6.0	4.0	1.5	1.5	200	200		
		10	12.5 to 25	12 to 20	3.0	2.0	1.0	1.0	350	350		
Slide table type LEPS Series	6	4	14 to 20	—	1.0	—	0.5	—	150	—	25 50	751
		8	7 to 10	—	0.75	—	0.25	—	300	—		
	10	5	25 to 50	24 to 40	2.0	2.0	1.5	1.5	200	200		
		10	12.5 to 25	12 to 20	1.5	1.5	1.0	1.0	350	350		

Mounting Variations

Mounting from various directions

Side mounting (Body mounting through-hole)

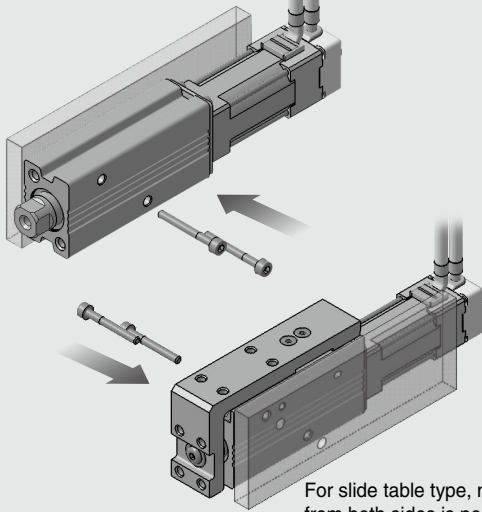

For slide table type, mounting from both sides is possible.

Side mounting (Body tapped)

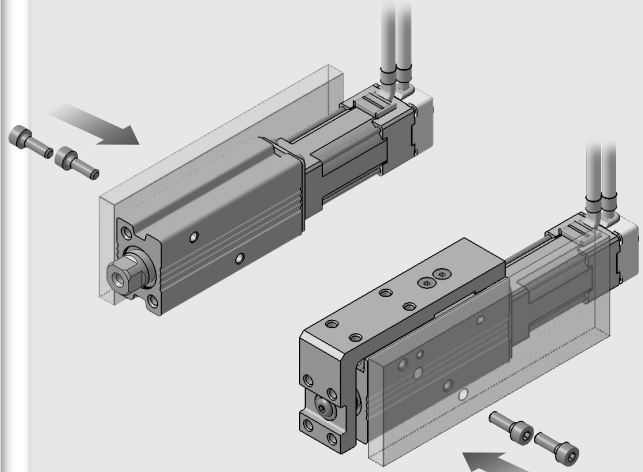

For slide table type, body tapped from both sides.

Bottom mounting (Body tapped)

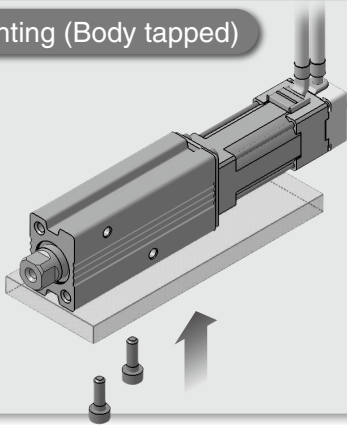

Axial mounting * Rod type only (Body tapped)

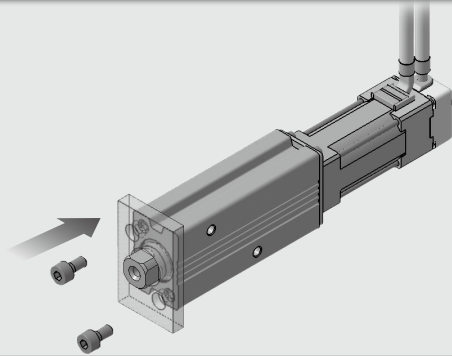

Motor Cable Entry Direction

Can be selected from 4 directions

Top entry (Basic model)

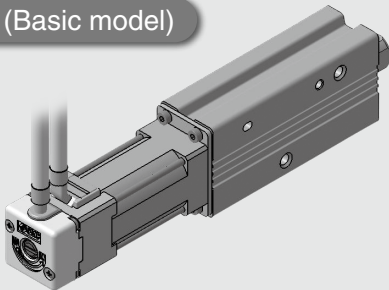

Entry on the right side (When selecting "R")

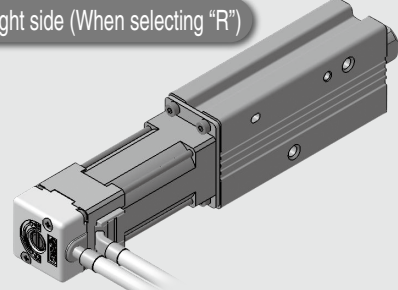

Bottom entry (When selecting "U")

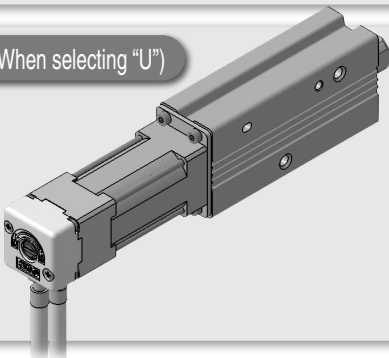

Entry on the left side (When selecting "L")

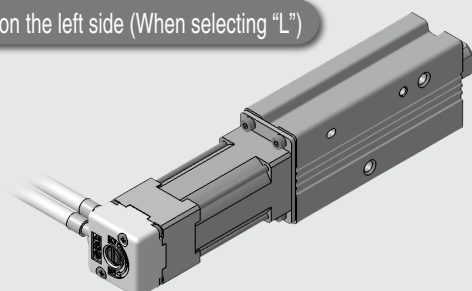

CONTENTS

Incremental (Step Motor 24 VDC)

Miniature Rod Type *LEPY Series*



Model Selection	p. 741
How to Order	p. 745
Specifications	p. 748
Construction	p. 748
Dimensions	p. 749

Incremental (Step Motor 24 VDC)

Miniature Slide Table Type *LEPS Series*



Model Selection	p. 751
How to Order	p. 757
Specifications	p. 760
Construction	p. 760
Dimensions	p. 761

Specific Product Precautions	p. 763
------------------------------------	--------

Incremental (Step Motor 24 VDC) Controllers

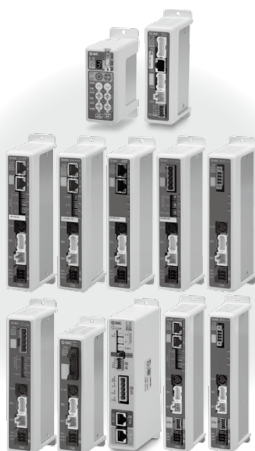

Step Data Input Type/ <i>JXC51/61 Series</i>	p. 1017
EtherCAT/EtherNet/IP™/PROFINET/DeviceNet®/IO-Link Direct Input Type/ <i>JXCE□/91/P1/D1/L□/M1 Series</i>	p. 1063
Gateway Unit/ <i>LEC-G Series</i>	p. 1038
Programless Controller/ <i>LECP1 Series</i>	p. 1042
Step Motor Driver/ <i>LECPA Series</i>	p. 1057
Actuator Cable	p. 1091
Communication Cable for Controller Setting/ <i>LEC-W2A-□</i>	p. 1094
Teaching Box/ <i>LEC-T1</i>	p. 1095

3-Axis Step Motor Controller



EtherNet/IP™ Type/ <i>JXC92 Series</i>	p. 1079
--	---------

4-Axis Step Motor (Servo/24 VDC) Controller



Parallel I/O Type/ <i>JXC73/83 Series</i>	p. 1081
EtherNet/IP™ Type/ <i>JXC93 Series</i>	p. 1081

Miniature Rod Type *LEPY Series*

Incremental (Step Motor 24 VDC)

p. 745



Miniature Slide Table Type *LEPS Series*

Incremental (Step Motor 24 VDC)

p. 757



Controllers/Drivers p. 994

Model Selection

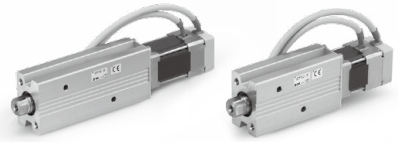

LEPY Series ▶ p. 745

Selection Procedure

Positioning Control Selection Procedure



Selection Example

Operating conditions

- Workpiece mass: 0.2 [kg]
- Speed: 200 [mm/s]
- Acceleration/Deceleration: 3000 [mm/s²]
- Stroke: 40 [mm]
- Workpiece mounting condition: Vertical upward downward transfer

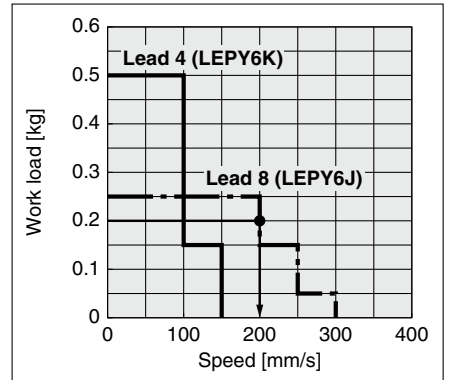
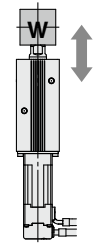

<Speed-Work load graph>
(LEPY6/Step motor)

Step 1 Check the work load-speed. <Speed-Work load graph>

Select a model based on the workpiece mass and speed while referencing the speed-work load graph.

Selection example) The LEPY6J can be temporarily selected as a possible candidate based on the graph shown on the right side.

* It is necessary to mount a guide outside the actuator when used for horizontal transfer. When selecting the target model, refer to the horizontal work load in the specifications on page 748 and the precautions.

Step 2 Check the cycle time.

Calculate the cycle time using the following calculation method.

Cycle time:

T can be found from the following equation.

$$T = T1 + T2 + T3 + T4 \text{ [s]}$$

- T1: Acceleration time and T3: Deceleration time can be found by the following equation.

$$T1 = V/a1 \text{ [s]} \quad T3 = V/a2 \text{ [s]}$$

- T2: Constant speed time can be found from the following equation.

$$T2 = \frac{L - 0.5 \cdot V \cdot (T1 + T3)}{V} \text{ [s]}$$

- T4: Settling time varies depending on the conditions such as motor types, load, and in position of the step data. Therefore, calculate the settling time while referencing the following value.

$$T4 = 0.2 \text{ [s]}$$

Calculation example)

T1 to T4 can be calculated as follows.

$$T1 = V/a1 = 200/3000 = 0.067 \text{ [s]}, \quad T3 = V/a2 = 200/3000 = 0.067 \text{ [s]}$$

$$T2 = \frac{L - 0.5 \cdot V \cdot (T1 + T3)}{V} = \frac{40 - 0.5 \cdot 200 \cdot (0.067 + 0.067)}{200} = 0.133 \text{ [s]}$$

$$T4 = 0.2 \text{ [s]}$$

The cycle time can be found as follows.

$$T = T1 + T2 + T3 + T4 = 0.067 + 0.133 + 0.067 + 0.2 = 0.467 \text{ [s]}$$

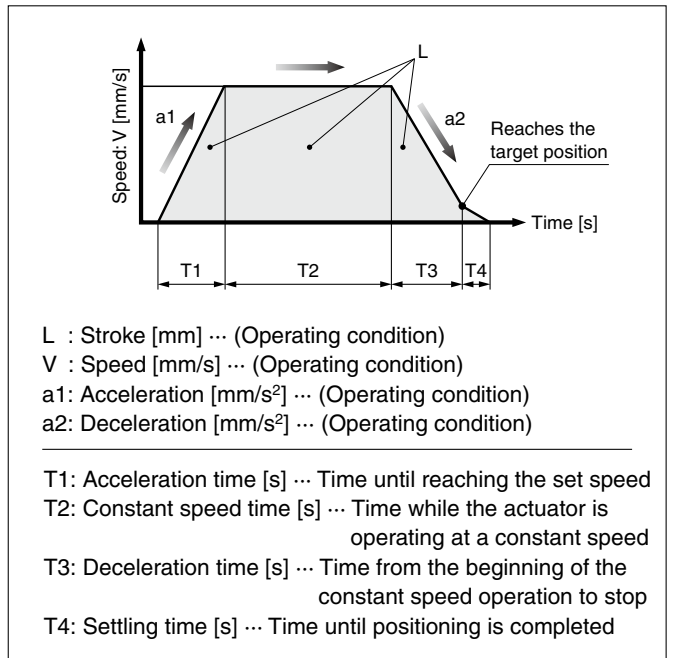

Based on the above calculation result, the LEPY6J-50 should be selected.

Selection Procedure

Pushing Control Selection Procedure



* The duty ratio is a ratio of the operation time in one cycle.

Selection Example

Operating conditions

- Mounting condition: Horizontal (pushing)
- Attachment weight: 0.05 [kg]
- Pushing force: 30 [N]
- Duty ratio: 70 [%]
- Speed: 150 [mm/s]
- Stroke: 40 [mm]

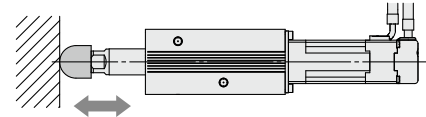

Step 1 Check the duty ratio.

<Conversion table of pushing force–duty ratio>

Select the [Pushing force] from the duty ratio while referencing the conversion table of pushing force–duty ratio.

Selection example)

Based on the table below,

- Duty ratio: 70 [%]

The pushing force set value will be 80 [%].

<Conversion table of pushing force–duty ratio> (LEPY10L)

Pushing force set value [%]	Duty ratio [%]	Continuous pushing time [min]
70 or less	100	No restriction
80	70	10 or less
100	50	5 or less

* [Pushing force set value] is one of the step data input to the controller.

* [Continuous pushing time] is the time that the actuator can continuously keep pushing.

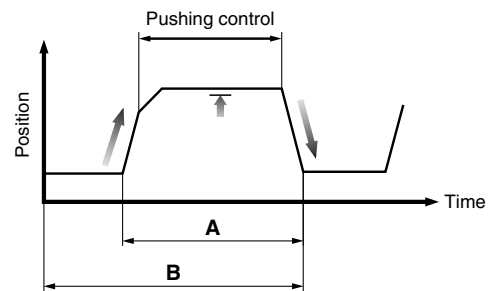

$$\text{Duty ratio} = A/B \times 100 [\%]$$

Step 2 Check the pushing force.

<Pushing force set value–Force graph>

Select a model based on the pushing force set value and force while referencing the pushing force set value–force graph.

Selection example)

Based on the graph shown on the right side,

- Pushing force set value: 75 [%]
- Pushing force: 30 [N]

The LEPY10LK can be temporarily selected as a possible candidate.

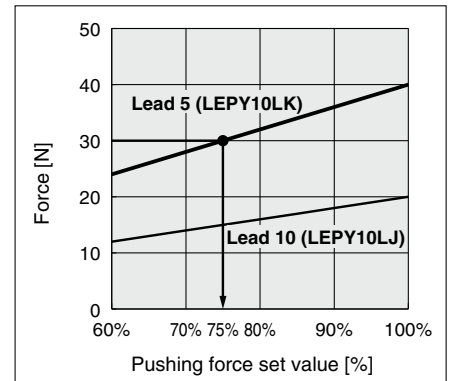

<Pushing force set value–Force graph> (LEPY10L)

Step 3 Check the lateral load on the rod end.

<Allowable lateral load on the rod end>

Confirm the allowable lateral load on the rod end of the actuator: LEPY10L, which has been selected temporarily while referencing the allowable lateral load on the rod end.

Selection example)

Based on the table below,

- Attachment weight: 0.05 [kg] \approx 0.5 [N]

The lateral load on the rod end is within the allowable range.

<Allowable lateral load on the rod end>

Model	Allowable lateral load on the rod end [N]
LEPY6 (Basic)	0.50
LEPY10 (Basic)	1.0
LEPY10L (Compact)	1.0

Based on the above calculation result, the LEPY10LK-50 should be selected.

LEPY Series

Incremental (Step Motor 24 VDC)

Speed-Work Load Graph (Guide)

* The following graphs show the values when the moving force is 150%.

LEPY6 (Basic)

Horizontal

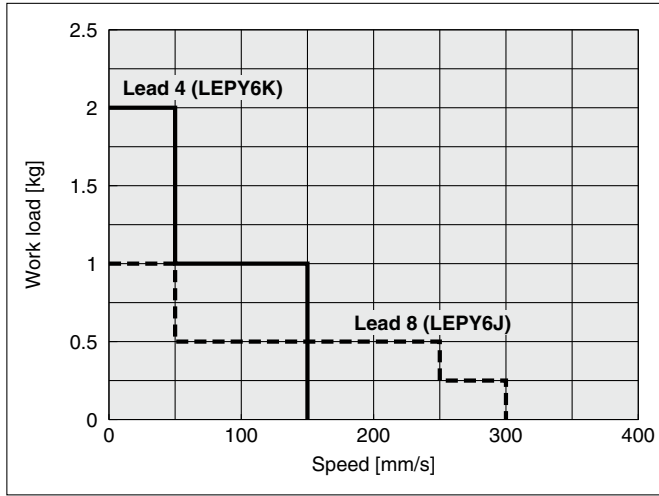

Vertical

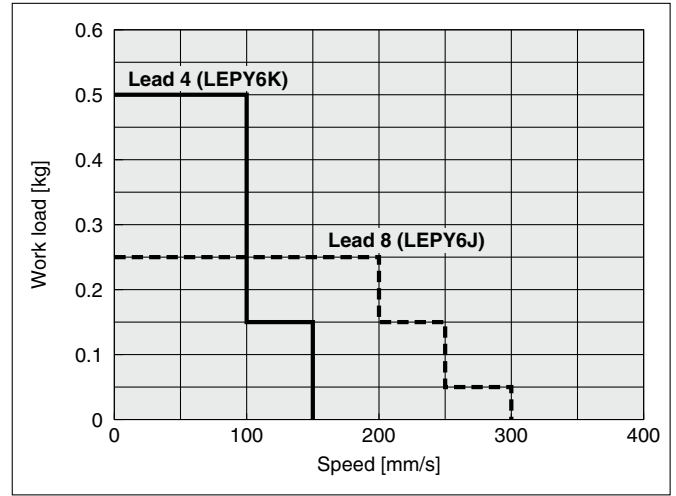

LEPY10L (Motor size: Compact)

Horizontal

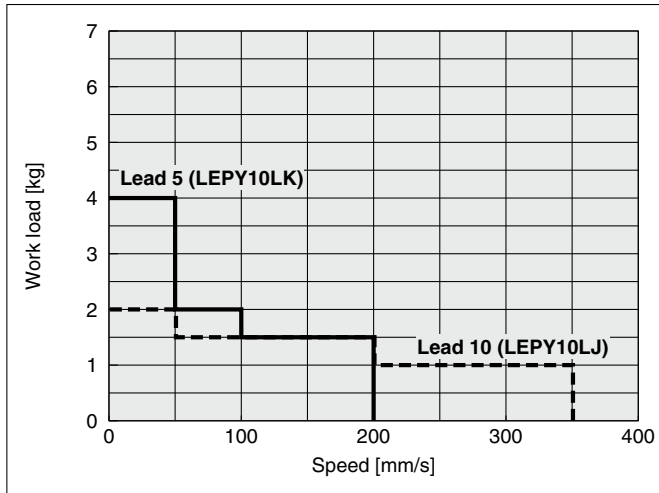

Vertical

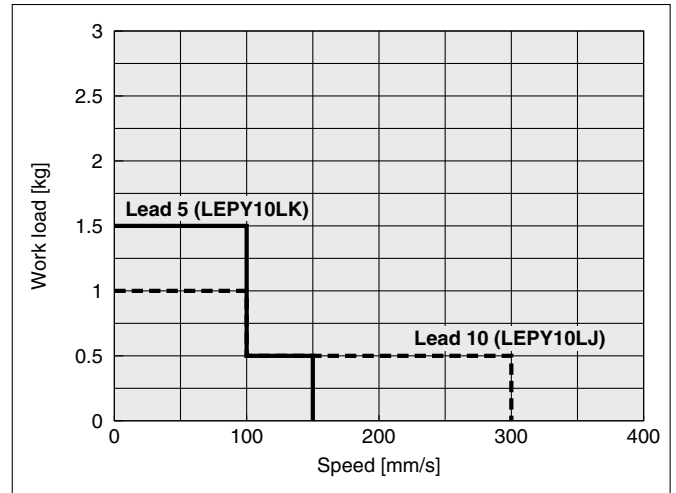

LEPY10 (Motor size: Basic)

Horizontal

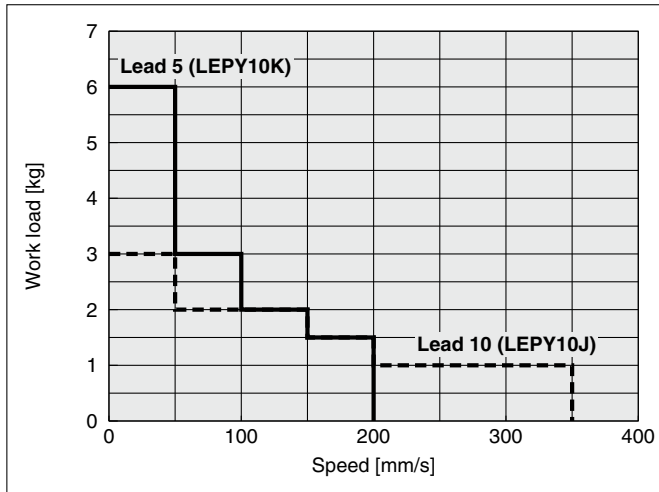

Vertical

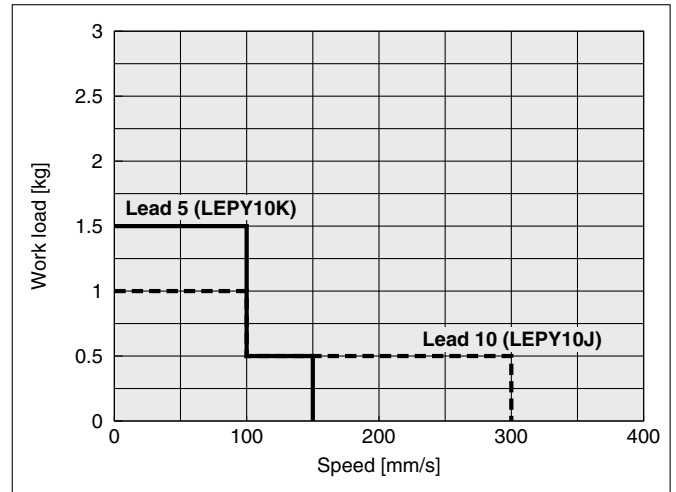

* The maximum value of the work load for the positioning operation. An external guide is necessary to support the load. The actual work load and transfer speed change according to the condition of the external guide.

Pushing Force Set Value–Force Graph (Guide)

LEPY6 (Basic)

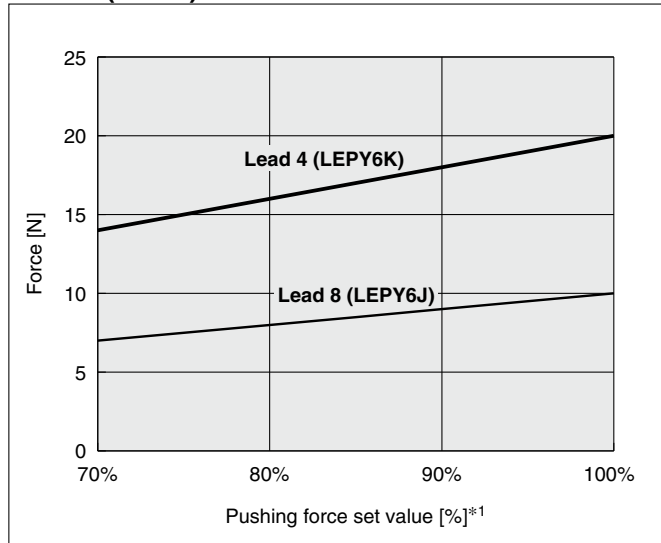

Pushing force set value [%]	Duty ratio [%]	Continuous pushing time [min]
70	100	No restriction
80	70	10 or less
100	50	5 or less

LEPY10 (Basic)

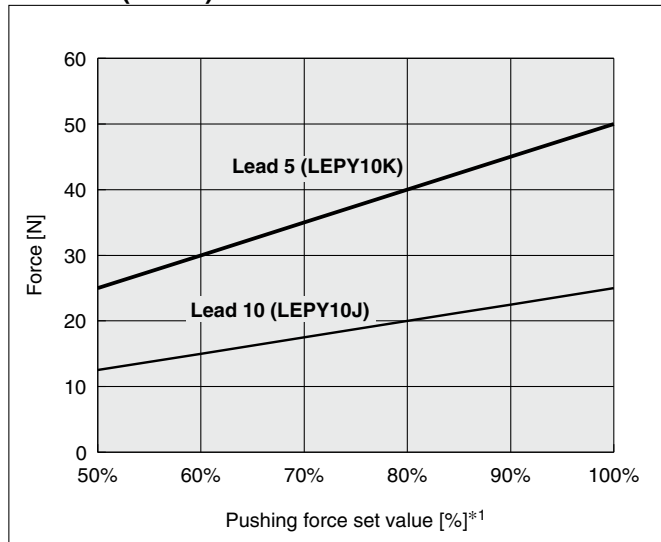

Pushing force set value [%]	Duty ratio [%]	Continuous pushing time [min]
60 or less	100	No restriction
70	30	3 or less
100	15	1 or less

LEPY10L (Compact)

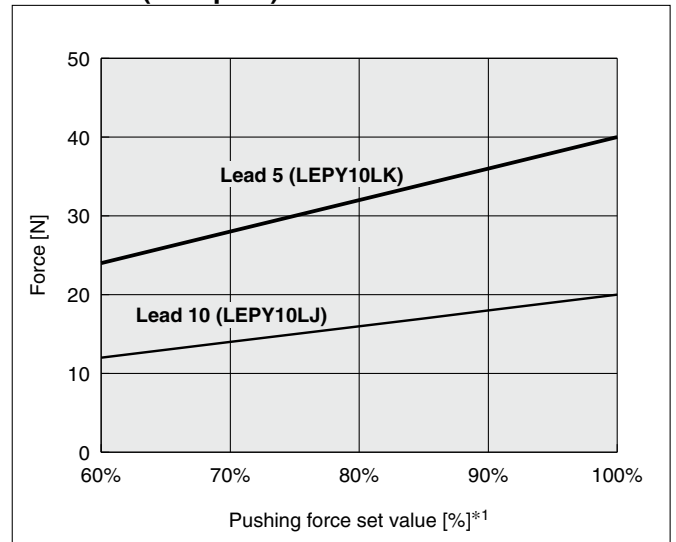

Pushing force set value [%]	Duty ratio [%]	Continuous pushing time [min]
70 or less	100	No restriction
80	70	10 or less
100	50	5 or less

*1 Set values for the controller

Allowable Lateral Load on the Rod End

Model	Allowable lateral load on the rod end [N]
LEPY6 (Basic)	0.50
LEPY10 (Basic)	1.0
LEPY10L (Compact)	1.0

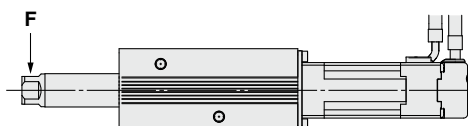

Incremental (Step Motor 24 VDC)

Miniature Rod Type

LEPY Series LEPY6, 10

CE c  US
* For details, refer to page 1343 and onward.

 RoHS



How to Order

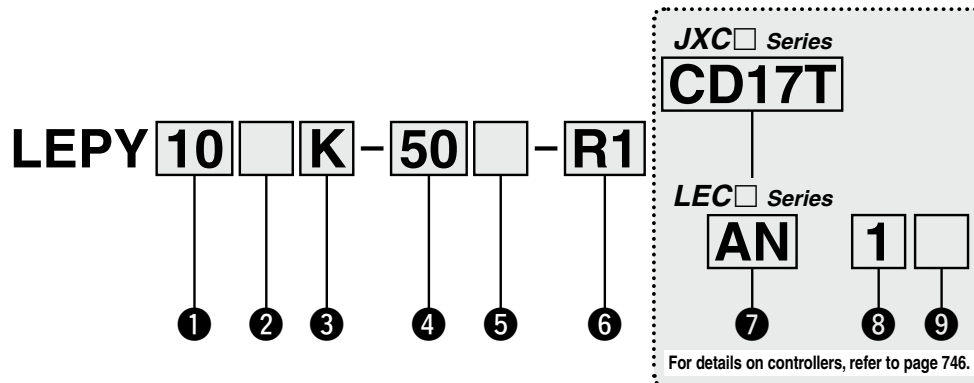

① Size

6
10

② Motor size

Symbol	Motor size	Applicable size
Nil	Basic	6, 10
L	Compact	10

③ Lead screw type [mm]

Symbol	Screw lead	
	LEPY6	LEPY10
K	4	5
J	8	10

④ Stroke [mm]

Symbol	Stroke
25	25
50	50
75	75

⑤ Motor cable mounting direction

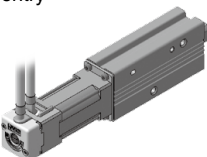
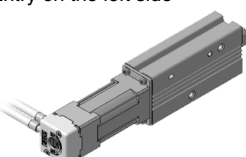
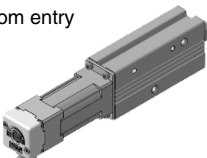
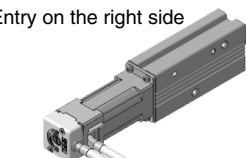
Nil	Top entry 	L	Entry on the left side 
	Bottom entry 		Entry on the right side 
U		R	

⑥ Actuator cable type/length*2

Standard cable [m]		Robotic cable [m]			
Nil	None	R1	1.5	RA	10*1
S1	1.5	R3	3	RB	15*1
S3	3	R5	5	RC	20*1
S5	5	R8	8*1		

JXC Series (For details, refer to page 747.)

7 Controller

Nil	Without controller
C□1□□	With controller

C D 1 7 T

Interface (Communication protocol/Input/Output)

Symbol	Type	Number of axes, Special specification	
		Standard	With STO sub-function
5	Parallel input (NPN)	●	
6	Parallel input (PNP)	●	
E	EtherCAT	●	●
9	EtherNet/IP™	●	●
P	PROFINET	●	●
D	DeviceNet®	●	
L	IO-Link	●	●
M	CC-Link	●	

Mounting

7	Screw mounting
8*7	DIN rail

Number of axes, Special specification

Symbol	Number of axes	Specification
1	Single axis	Standard
F	Single axis	With STO sub-function

Communication plug connector, I/O cable*8

Symbol	Type	Applicable interface
Nil	Without accessory	—
S	Straight type communication plug connector	DeviceNet®
T	T-branch type communication plug connector	CC-Link Ver. 1.10
1	I/O cable (1.5 m)	Parallel input (NPN) Parallel input (PNP)
3	I/O cable (3 m)	
5	I/O cable (5 m)	



LEC Series (For details, refer to page 747.)

AN 1 □

7 8 9

7 Controller/Driver type*3

Nil	Without controller/driver	
1N	LECP1 (Programless type)	NPN
1P		PNP
AN	LECPA *4 (Pulse input type)	NPN
AP		PNP

8 I/O cable length*5

Nil	Without cable (Without communication plug connector)	
1	1.5 m	
3	3 m*6	
5	5 m*6	

9 Controller/Driver mounting

Nil	Screw mounting
D	DIN rail*7



- *1 Produced upon receipt of order (Robotic cable only)
- *2 The standard cable should only be used on fixed parts.
For use on moving parts, select the robotic cable.
Refer to page 1092 if only the actuator cable is required.
- *3 For details on controllers/drivers and compatible motors, refer to the compatible controllers/drivers on the next page.
- *4 When pulse signals are open collector, order the current limiting resistor (LEC-PA-R-□) on page 1062 separately.
- *5 When "Without controller/driver" is selected for controller/driver types, I/O cable cannot be selected. Refer to page 1047 (For LECP1) or page 1062 (For LECPA) if an I/O cable is required.

- *6 When "Pulse input type" is selected for controller/driver types, pulse input usable only with differential. Only 1.5 m cables usable with open collector
- *7 The DIN rail is not included. It must be ordered separately.
- *8 Select "Nil" for anything other than DeviceNet®, CC-Link, or parallel input.
Select "Nil," "S," or "T" for DeviceNet® or CC-Link.
Select "Nil," "1," "3," or "5" for parallel input.

⚠ Caution

[CE/UKCA-compliant products]

① EMC compliance was tested by combining the electric actuator LEP series and the controller LEC/JXC series.
The EMC depends on the configuration of the customer's control panel and the relationship with other electrical equipment and wiring. Therefore, compliance with the EMC directive cannot be certified for SMC components incorporated into the customer's equipment under actual operating conditions. As a result, it is necessary for the customer to verify compliance with the EMC directive for the machinery and equipment as a whole.

[UL-compliant products (For the LEC series)]

When compliance with UL is required, the electric actuator and controller/driver should be used with a UL1310 Class 2 power supply.

The actuator and controller/driver are sold as a package.

Confirm that the combination of the controller/driver and the actuator is correct.

<Check the following before use.>

- ① Check the actuator label for the model number. This number should match that of the controller/driver.
- ② Check that the Parallel I/O configuration matches (NPN or PNP).

LEPY6K-25U

NPN

①

②















* Refer to the Operation Manual for using the products. Please download it via our website: <https://www.smcworld.com>

LEPY Series

Incremental (Step Motor 24 VDC)

Compatible Controllers/Drivers

Type	Step data input type 	Programless type 	Pulse input type 
Series	JXC51 JXC61	LECP1	LECPA
Features	Parallel I/O	Capable of setting up operation (step data) without using a PC or teaching box	Operation by pulse signals
Compatible motor	Step motor (Servo/24 VDC)		
Max. number of step data	64 points	14 points	—
Power supply voltage	24 VDC		
Reference page	1017	1042	1057

Type	EtherCAT direct input type 	EtherCAT direct input type with STO sub-function 	EtherNet/IP™ direct input type 	EtherNet/IP™ direct input type with STO sub-function 	PROFINET direct input type 	PROFINET direct input type with STO sub-function 	DeviceNet® direct input type 	IO-Link direct input type 	IO-Link direct input type with STO sub-function 	CC-Link direct input type 
Series	JXCE1	JXCEF	JXC91	JXC9F	JXCP1	JXC9F	JXCD1	JXCL1	JXCLF	JXCM1
Features	EtherCAT direct input	EtherCAT direct input with STO sub-function	EtherNet/IP™ direct input	EtherNet/IP™ direct input with STO sub-function	PROFINET direct input	PROFINET direct input with STO sub-function	DeviceNet® direct input	IO-Link direct input	IO-Link direct input with STO sub-function	CC-Link direct input
Compatible motor	Step motor (Servo/24 VDC)									
Max. number of step data	64 points									
Power supply voltage	24 VDC									
Reference page	1063									

Specifications



Weight

Model		LEPY6		
Stroke [mm]		25	50	75
Product weight [kg]	Basic	0.24	0.29	0.34

Model		LEPY10		
Stroke [mm]		25	50	75
Product weight [kg]	Basic	0.47	0.55	0.65
	Compact	0.41	0.49	0.59

Model		LEPY6		LEPY10		
Screw lead [mm]		4	8	5	10	
Pushing force [N]*1 *6		Basic		14 to 20	7 to 10	
		Compact		—	—	
Work load [kg]*2 *3 *6		Horizontal	Basic		2.0	1.0
			Compact		—	—
		Vertical	Basic		0.5	0.25
			Compact		—	—
Speed [mm/s]*3 *6		Horizontal	Basic		10 to 150	20 to 300*4
			Compact		—	—
		Vertical	Basic		10 to 150	20 to 300*4
			Compact		—	—
Pushing speed [mm/s]*5		10	20	10	20	
Acceleration/Deceleration [mm/s ²]		3000				
Backlash [mm]		0.2 or less				
Positioning repeatability [mm]		±0.05				
Lost motion [mm]*7		0.2 or less				
Impact/Vibration resistance [m/s ²]*8		50/20				
Actuation type		Slide screw				
Guide type		Sliding bushing				
Max. operating frequency [c.p.m]		60				
Operating temperature range [°C]		5 to 40				
Operating humidity range [%RH]		90 or less (No condensation)				
Enclosure		IP40				
Motor size		□20		□28		
Motor type		Step motor (Servo/24 VDC)				
Encoder		Incremental				
Power supply voltage [V]		24 VDC ±10%				
Power [W]*9		Basic		Max. power 22		
		Compact		—		
				Max. power 55		
				Max. power 45		

*1 Pushing force accuracy is LEPY6: ±30% (F.S.), LEPY10: ±25% (F.S.).

Refer to pages 764 and 765 for the detailed setting range and precautions.

The pushing force and the duty ratio change according to the set value. Check the "Pushing Force Set Value–Force Graph (Guide)" on page 744 and [14] on page 765.

*2 The maximum value of the work load for the positioning operation. An external guide is necessary to support the load. The actual work load and transfer speed change according to the condition of the external guide.

*3 Speed changes according to the work load. Check the "Speed–Work Load Graph (Guide)" on page 743.

*4 When the stroke is 25 mm, the maximum speed will be 250 mm/s.

*5 Set to the pushing speed when pushing operation.

*6 The speed and force may change depending on the cable length, load and mounting conditions. Furthermore, if the cable length exceeds 5 m, then it will decrease by up to 10% for each 5 m. (At 15 m: Reduced by up to 20%)

*7 A reference value for correcting errors in reciprocal operation

*8 Impact resistance: No malfunction occurred when the actuator was tested with a drop tester in both an axial direction and a perpendicular direction to the lead screw. (The test was performed with the actuator in the initial state.)

Vibration resistance: No malfunction occurred in a test ranging between 45 to 2000 Hz. The test was performed in both an axial direction and a perpendicular direction to the lead screw. (The test was performed with the actuator in the initial state.)

*9 Indicates the max. power during operation (including the controller)

This value can be used for the selection of the power supply.

Construction

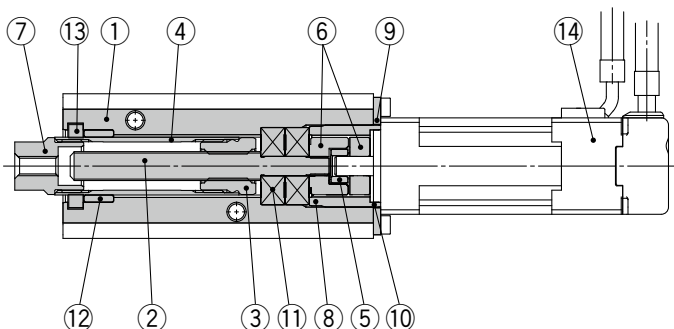

Component Parts

No.	Description	Material	Note
1	Body	Aluminum alloy	Anodized
2	Screw shaft	Stainless steel	Heat treatment + Special treatment
3	Screw nut	Stainless steel	Heat treatment + Special treatment
4	Rod	Stainless steel	
5	Spider	NBR	
6	Hub	Aluminum alloy	
7	Socket	Free cutting carbon steel	Nickel plating
8	Bearing stopper	Size 6: Aluminum alloy Size 10: Carbon steel	
9	Motor plate	Aluminum alloy	Anodized
10	Guide ring	Aluminum alloy	Size 10 only
11	Bearing	—	
12	Bushing	Bearing alloy	
13	Soft wiper	—	
14	Motor	—	

LEPY Series

Incremental (Step Motor 24 VDC)

Dimensions

LEPY6

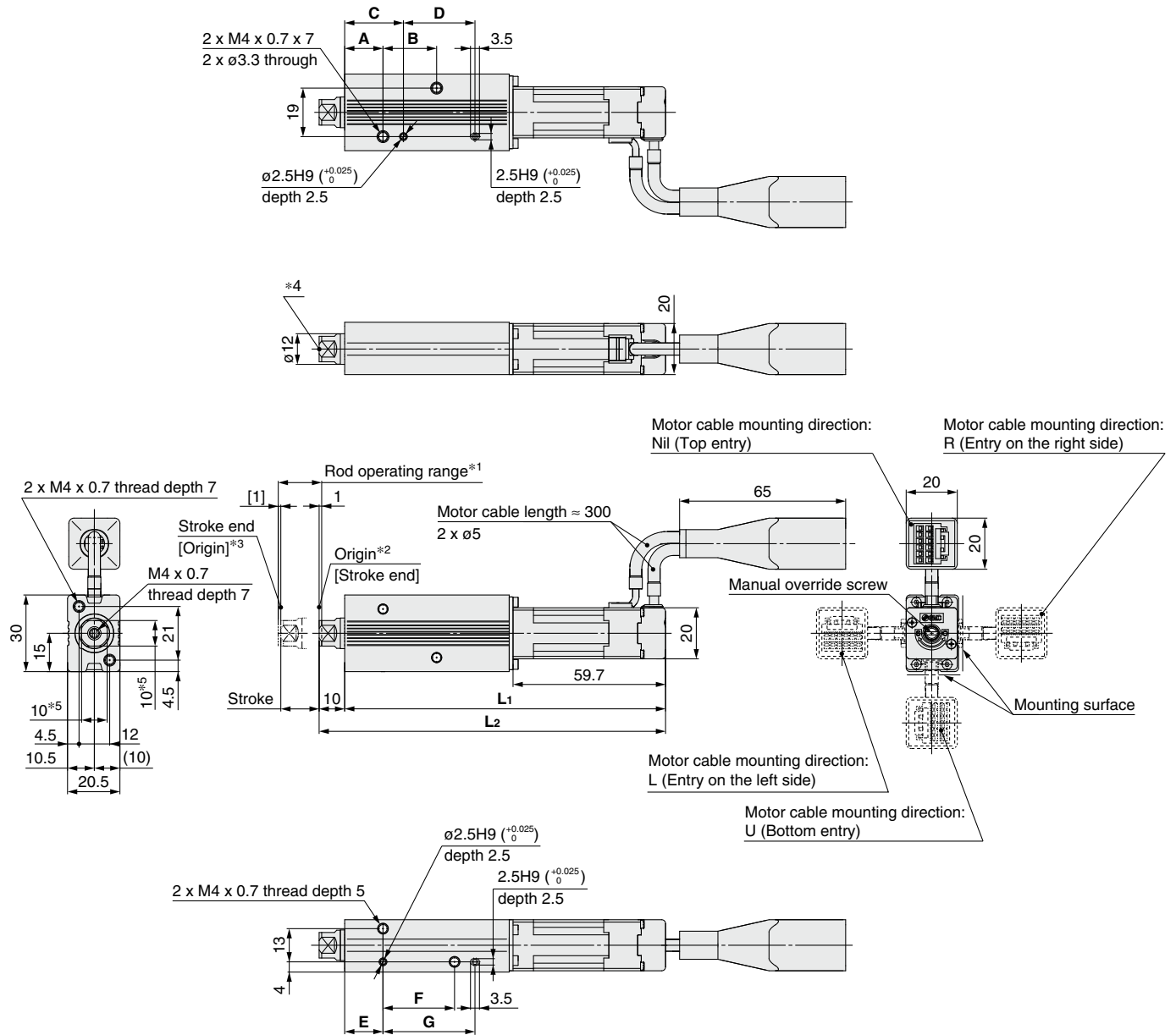

- *1 This is the range within which the rod can move when it returns to origin.
Make sure that workpieces mounted on the rod do not interfere with other workpieces or the facilities around the rod.
- *2 Position after returning to origin
- *3 [] for when the direction of return to origin has changed
- *4 Do not apply rotational torque to the rod end.
- *5 The direction of rod end width across flats (□10) differs depending on the products.

Dimensions

[mm]

Model	L ₁	L ₂	A	B	C	D	E	F	G
LEPY6□-25□	125.6	135.6	15	21	23	28	15	28	36
LEPY6□-50□	156.6	166.6	22	45	30	52	22	52	60
LEPY6□-75□	188.6	198.6	29	70	37	77	29	77	85

Dimensions

LEPY10

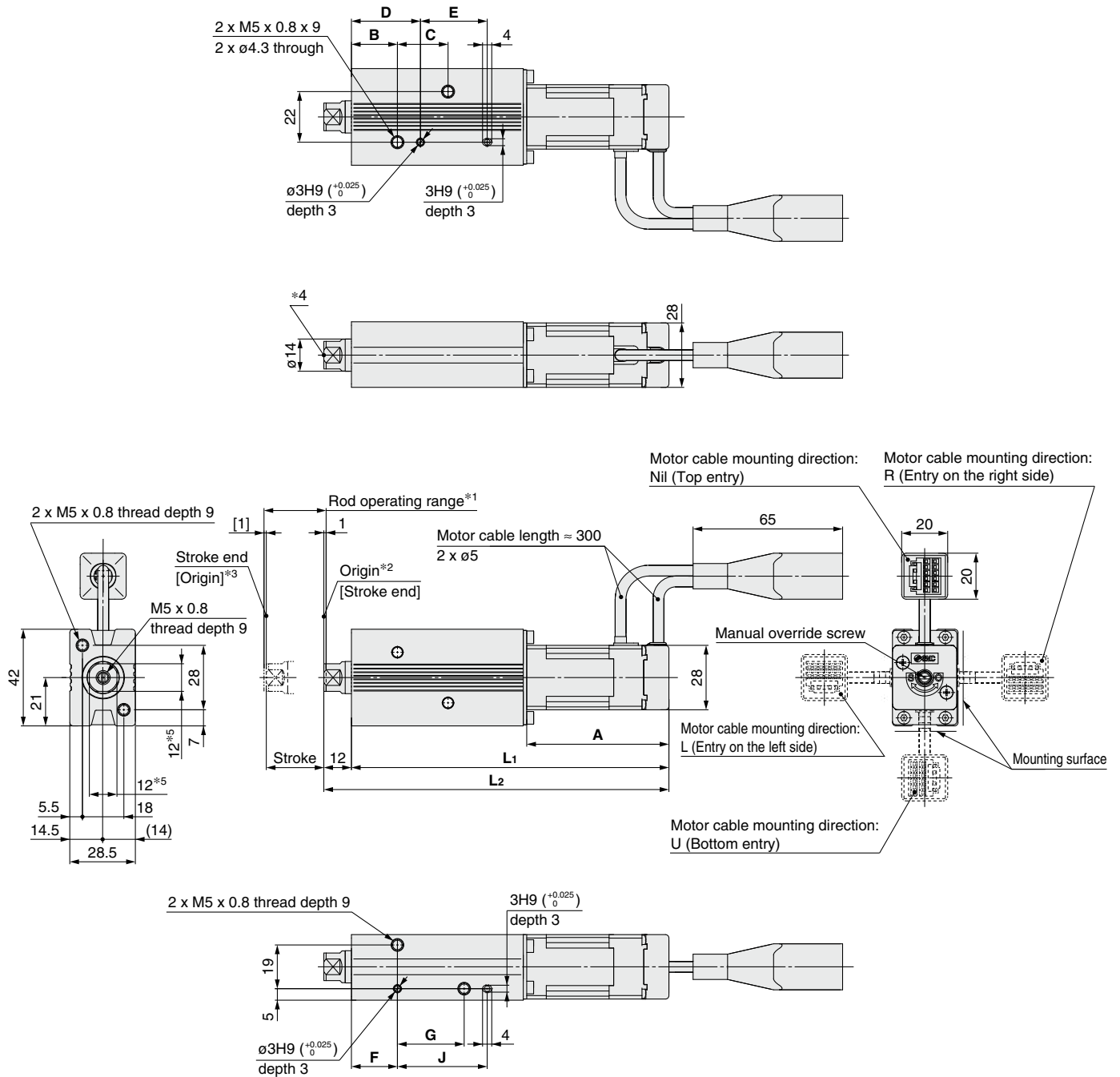

- *1 This is the range within which the rod can move when it returns to origin.
Make sure that workpieces mounted on the rod do not interfere with other workpieces or the facilities around the rod.
- *2 Position after returning to origin
- *3 [] for when the direction of return to origin has changed
- *4 Do not apply rotational torque to the rod end.
- *5 The direction of rod end width across flats (□12) differs depending on the products.

Dimensions

[mm]

Model	L ₁	L ₂	A	B	C	D	E	F	G	J
LEPY10□-25□	138	150	61.8	20	22	30	29	20	29	39
LEPY10□-50□	163	175		24	43	34	50	24	50	60
LEPY10□-75□	198	210		30	72	40	79	30	79	89
LEPY10L□-25□	124	136	47.8	20	22	30	29	20	29	39
LEPY10L□-50□	149	161		24	43	34	50	24	50	60
LEPY10L□-75□	184	196		30	72	40	79	30	79	89

Model Selection

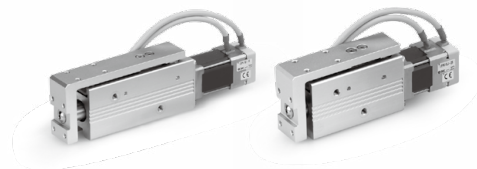

LEPS Series ▶ p. 757

Selection Procedure

Positioning Control Selection Procedure



Selection Example

Operating conditions

- Workpiece mass: 0.25 [kg]
- Speed: 200 [mm/s]
- Acceleration/Deceleration: 3000 [mm/s²]
- Stroke: 20 [mm]
- Workpiece mounting condition: Horizontal transfer

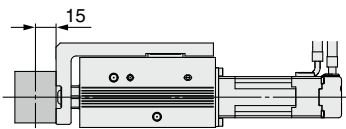

LEPS6 (Basic)

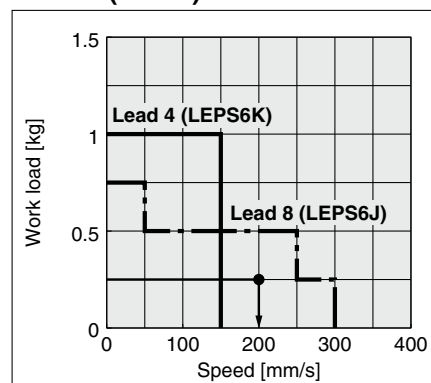

<Speed-Work load graph>
(LEPS6/Step motor)

Step 1 Check the work load-speed. <Speed-Work load graph>

Select a model based on the workpiece mass and speed while referencing the speed-work load graph.

Selection example) The **LEPS6J** can be temporarily selected as a possible candidate based on the graph shown on the right side.

Step 2 Check the cycle time.

Calculate the cycle time using the following calculation method.

Cycle time:

T can be found from the following equation.

$$T = T1 + T2 + T3 + T4 \text{ [s]}$$

- T1: Acceleration time and T3: Deceleration time can be found by the following equation.

$$T1 = V/a1 \text{ [s]} \quad T3 = V/a2 \text{ [s]}$$

- T2: Constant speed time can be found from the following equation.

$$T2 = \frac{L - 0.5 \cdot V \cdot (T1 + T3)}{V} \text{ [s]}$$

- T4: Settling time varies depending on the conditions such as motor types, load and in position of the step data. Therefore, calculate the settling time while referencing the following value.

$$T4 = 0.2 \text{ [s]}$$

Calculation example)

T1 to T4 can be calculated as follows.

$$T1 = V/a1 = 200/3000 = 0.067 \text{ [s]}, \quad T3 = V/a2 = 200/3000 = 0.067 \text{ [s]}$$

$$T2 = \frac{L - 0.5 \cdot V \cdot (T1 + T3)}{V} = \frac{20 - 0.5 \cdot 200 \cdot (0.067 + 0.067)}{200} = 0.033 \text{ [s]}$$

$$T4 = 0.2 \text{ [s]}$$

The cycle time can be found as follows.

$$T = T1 + T2 + T3 + T4 = 0.067 + 0.033 + 0.067 + 0.2 = 0.367 \text{ [s]}$$

Step 3 Check the guide allowable moment.

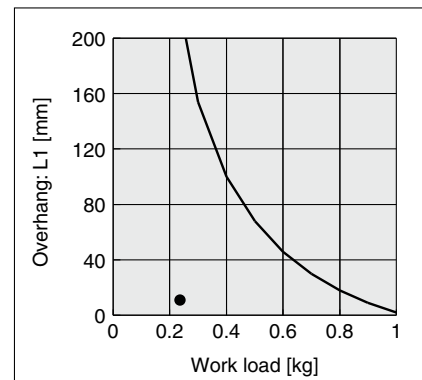
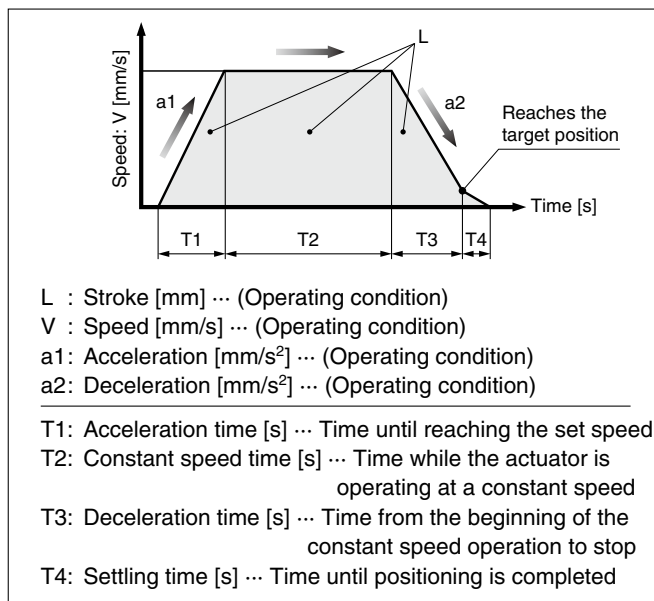

Guide allowable moment

Based on the above calculation result, the **LEPS6J-25** should be selected.

Selection Procedure

Pushing Control Selection Procedure



* The duty ratio is a ratio of the operation time in one cycle.

Selection Example

Operating conditions

- Mounting condition: Horizontal (pushing)
- Attachment weight: 0.4 [kg]
- Pushing force: 30 [N]
- Duty ratio: 70 [%]
- Speed: 150 [mm/s]
- Stroke: 40 [mm]

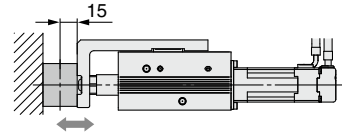

Step 1 Check the duty ratio.

<Conversion table of pushing force–duty ratio>

Select the [Pushing force] from the duty ratio while referencing the conversion table of pushing force–duty ratio.

Selection example)

Based on the table below,

- Duty ratio: 70 [%]

The pushing force set value will be 80 [%].

<Conversion table of pushing force–duty ratio>

(LEPS10L)

Pushing force set value [%]	Duty ratio [%]	Continuous pushing time [min]
70 or less	100	No restriction
80	70	10 or less
100	50	5 or less

* [Pushing force set value] is one of the step data input to the controller.

* [Continuous pushing time] is the time that the actuator can continuously keep pushing.

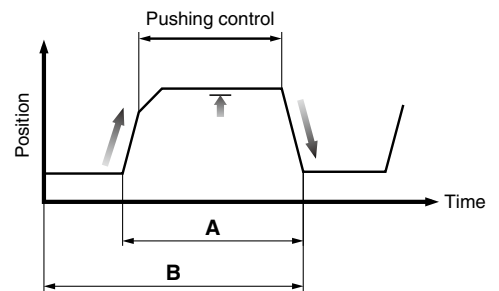

Duty ratio = A/B x 100 [%]

Step 2 Check the pushing force.

<Pushing force set value–Force graph>

Select a model based on the pushing force set value and force while referencing the pushing force set value–force graph.

Selection example)

Based on the graph shown on the right side,

- Pushing force set value: 75 [%]
- Pushing force: 30 [N]

The LEPS10LK can be temporarily selected as a possible candidate.

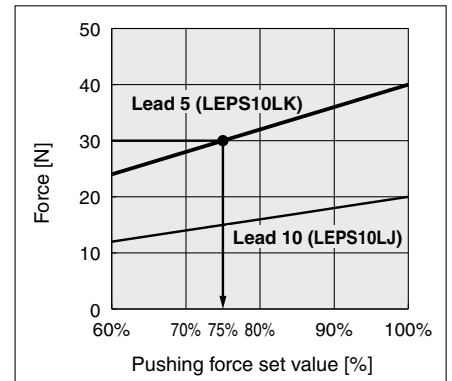

<Pushing force set value–Force graph> (LEPS10L)

Step 3 Check the guide allowable moment.

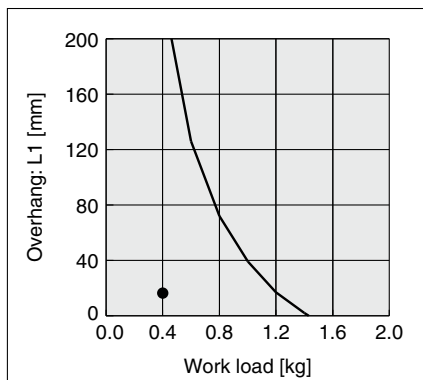

Based on the above calculation result, the LEPS10LK-50 should be selected.

LEPS Series

Incremental (Step Motor 24 VDC)

Speed-Work Load Graph (Guide)

* The following graphs show the values when the moving force is 150%.

LEPS6 (Basic)

Horizontal

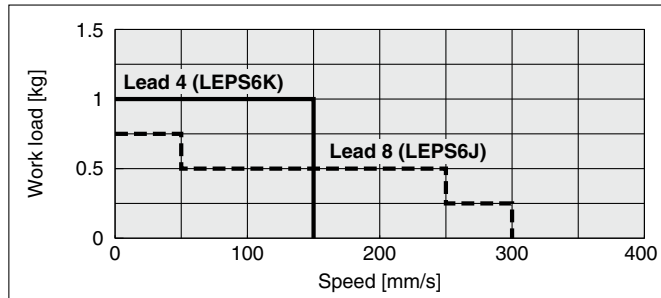

Vertical

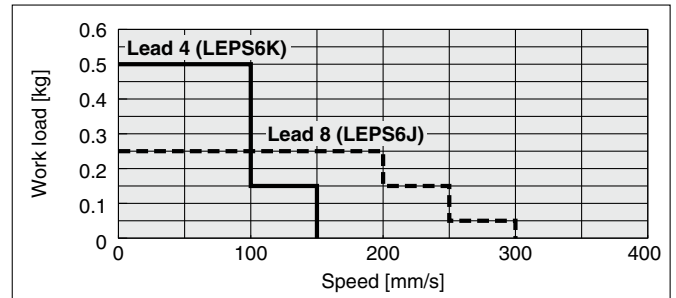

LEPS10(L) (Motor size: Basic/Compact)

Horizontal

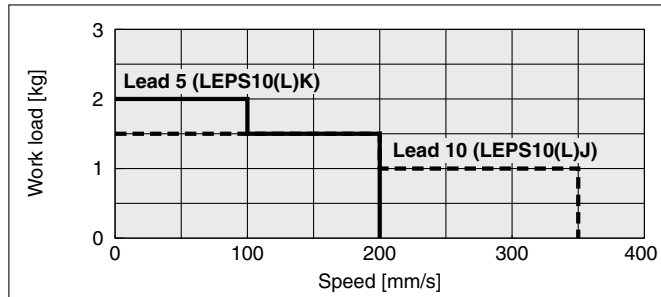

Vertical

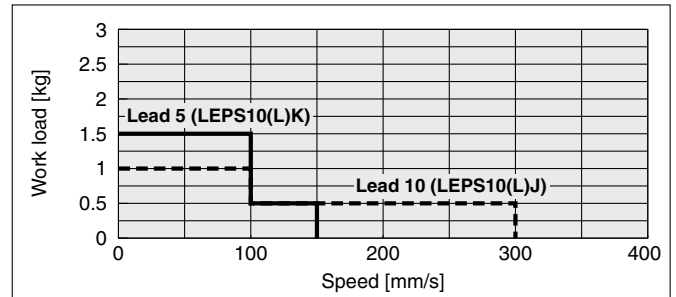

Pushing Force Set Value-Force Graph (Guide)

LEPS6 (Basic)

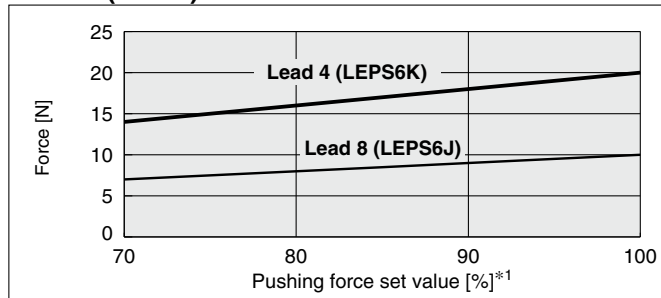

Pushing force set value [%]	Duty ratio [%]	Continuous pushing time [min]
70	100	No restriction
80	70	10 or less
100	50	5 or less

*1 Set values for the controller

LEPS10 (Basic)

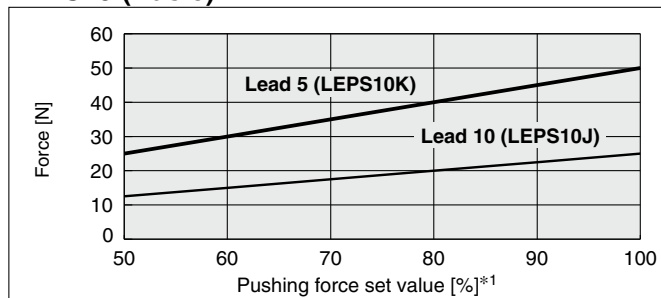

Pushing force set value [%]	Duty ratio [%]	Continuous pushing time [min]
60 or less	100	No restriction
70	30	3 or less
100	15	1 or less

LEPS10L (Compact)

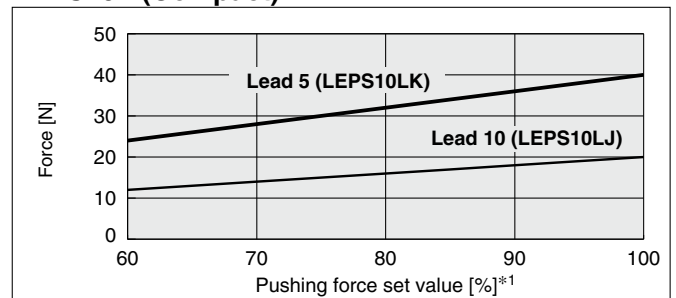

Pushing force set value [%]	Duty ratio [%]	Continuous pushing time [min]
70 or less	100	No restriction
80	70	10 or less
100	50	5 or less

* These graphs show the amount of allowable overhang (guide unit) when the center of gravity of the workpiece overhangs in one direction. When selecting the overhang, refer to the Electric Actuator Model Selection Software for confirmation: <https://www.smcworld.com>

Dynamic Allowable Moment

Acceleration/Deceleration — 3000 mm/s²

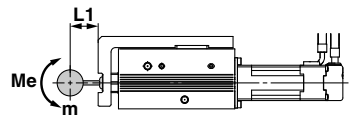
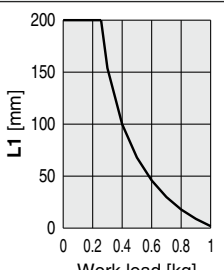
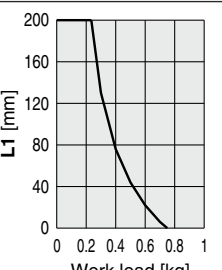
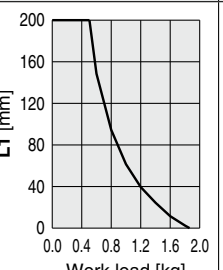
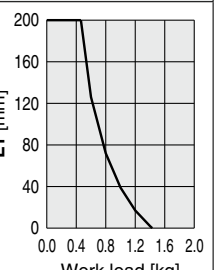
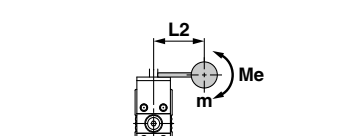
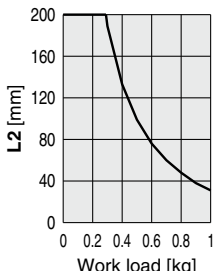
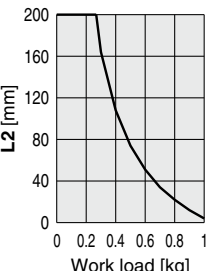
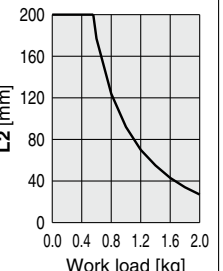
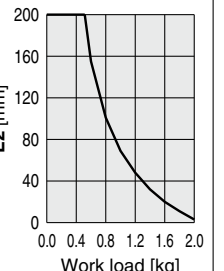
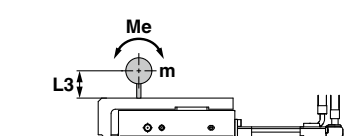
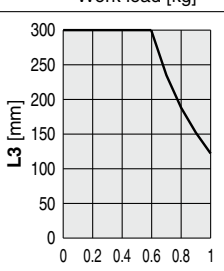
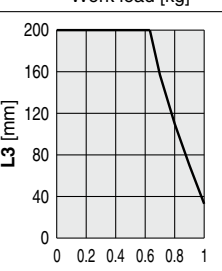
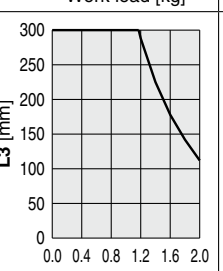
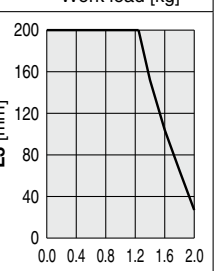
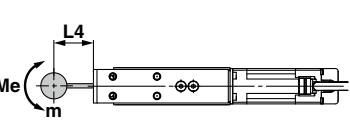
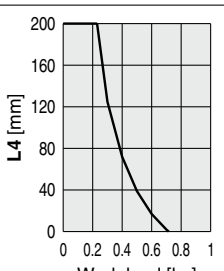
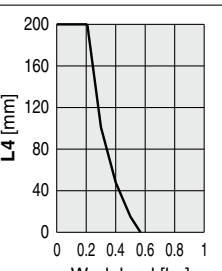
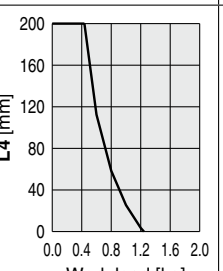
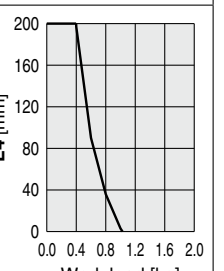
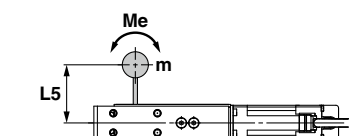
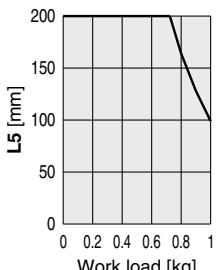
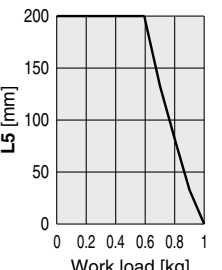
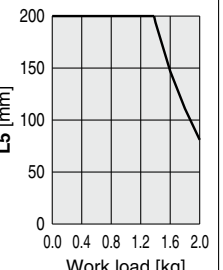
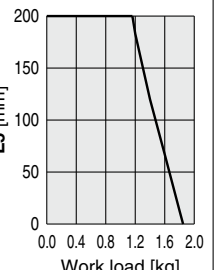
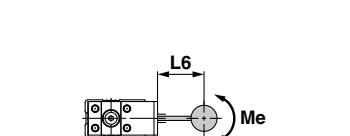
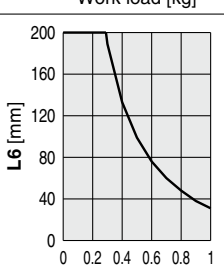
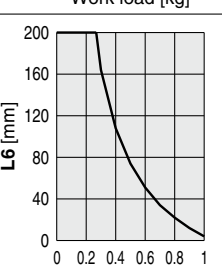
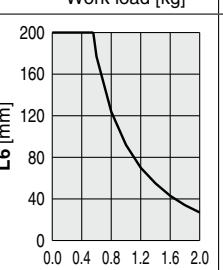
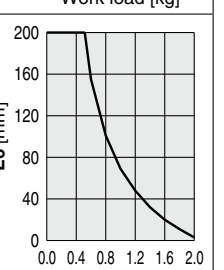
Orientation		Load overhanging direction m : Work load [kg] Me: Allowable moment [N·m] L : Overhang to the work load center of gravity [mm]	Model			
			LEPS6		LEPS10	
			LEPS6□-25	LEPS6□-50	LEPS10□-25	LEPS10□-50
Horizontal/Bottom		X				
		Y				
		Z				
Wall		X				
		Y				
		Z				





LEPS Series

Incremental (Step Motor 24 VDC)

* These graphs show the amount of allowable overhang (guide unit) when the center of gravity of the workpiece overhangs in one direction. When selecting the overhang, refer to the Electric Actuator Model Selection Software for confirmation: <https://www.smcworld.com>

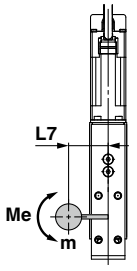
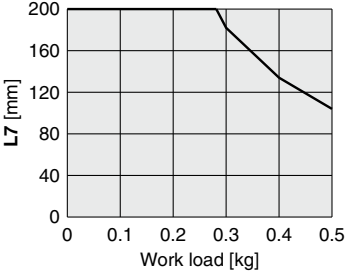
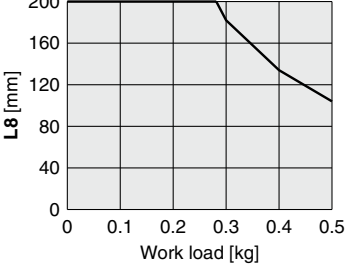
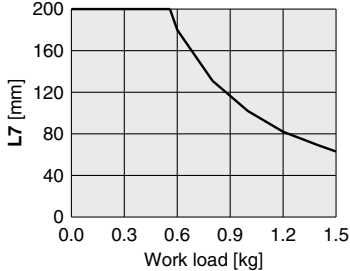
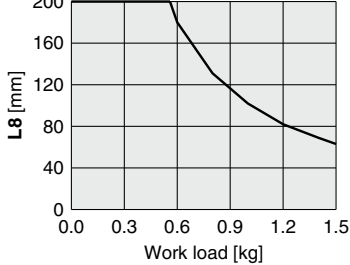
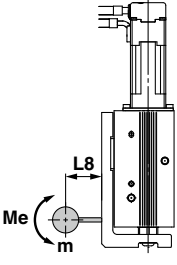
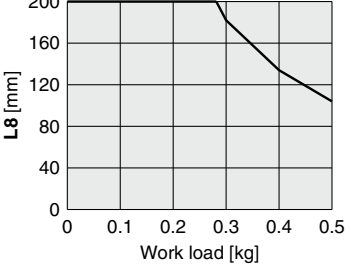
Dynamic Allowable Moment

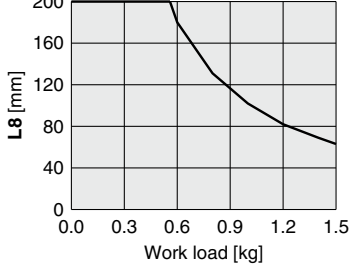
Acceleration/Deceleration — 3000 mm/s²

Orientation	Load overhanging direction m : Work load [kg] Me: Allowable moment [N·m] L : Overhang to the work load center of gravity [mm]	Model			
		LEPS6		LEPS10	
		LEPS6□-25	LEPS6□-50	LEPS10□-25	LEPS10□-50
Vertical	 <p style="text-align: center;">Y</p>				
	 <p style="text-align: center;">Z</p>				

Static Allowable Moment

Model	Allowable moment [N·m]		
	Pitch moment	Yaw moment	Roll moment
	M_p	M_y	M_r
LEPS6	1.07	1.07	2.51
LEPS10	2.55	2.55	5.47

Traveling Parallelism

Traveling parallelism	Stroke [mm]	
	25	50
	0.05 mm or less	0.1 mm or less

Table Deflection (Reference Value)

* These values are initial guideline values.

Table displacement due to pitch moment load (marked with the arrow)

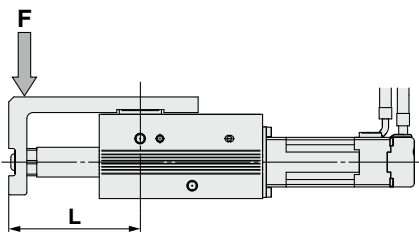

Table displacement due to yaw moment load (marked with the arrow)

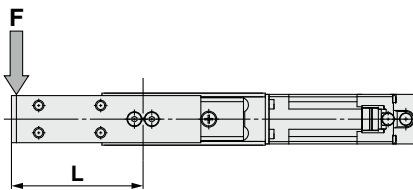
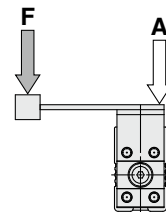

Table displacement due to roll moment load (marked with the arrow)



Distance L [mm]

Model	LEPS6		LEPS10	
Stroke [mm]	25	50	25	50
Distance L [mm]	53.0	77.0	59.5	82.0

LEPS6

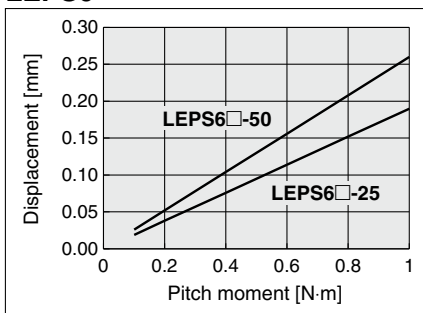

LEPS6

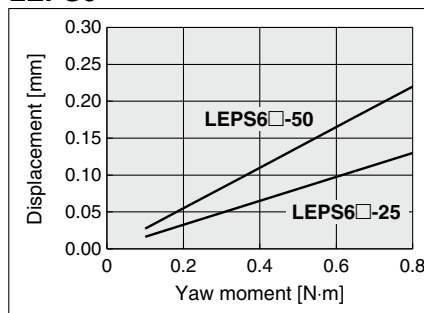

LEPS6

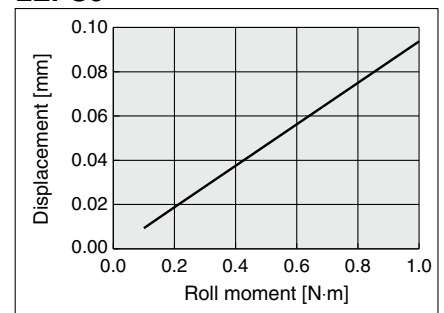

LEPS10

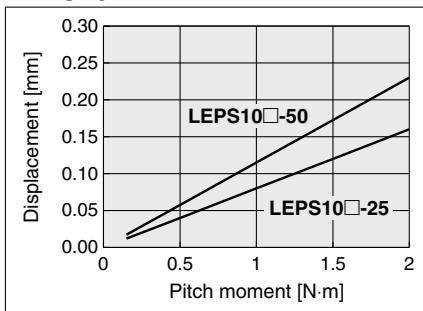

LEPS10

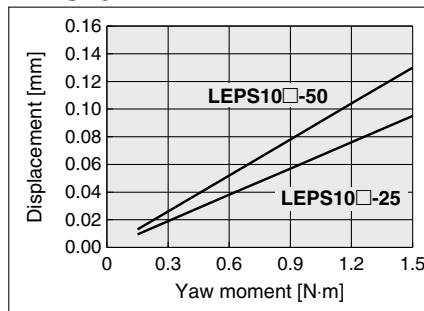

LEPS10

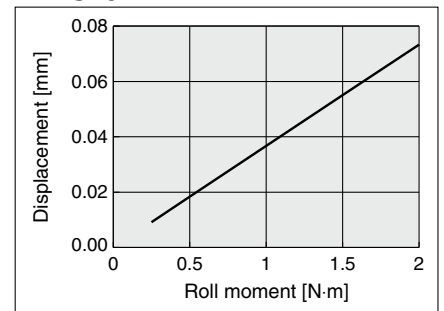

Incremental (Step Motor 24 VDC)

Miniature Slide Table Type



LEPS Series LEPS6, 10

RoHS

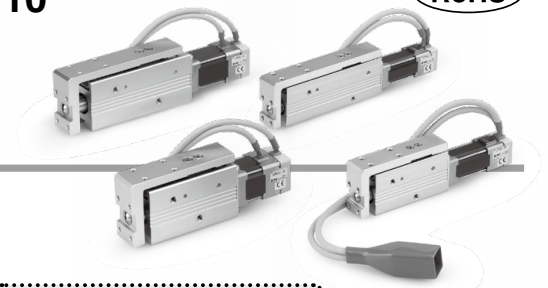

How to Order

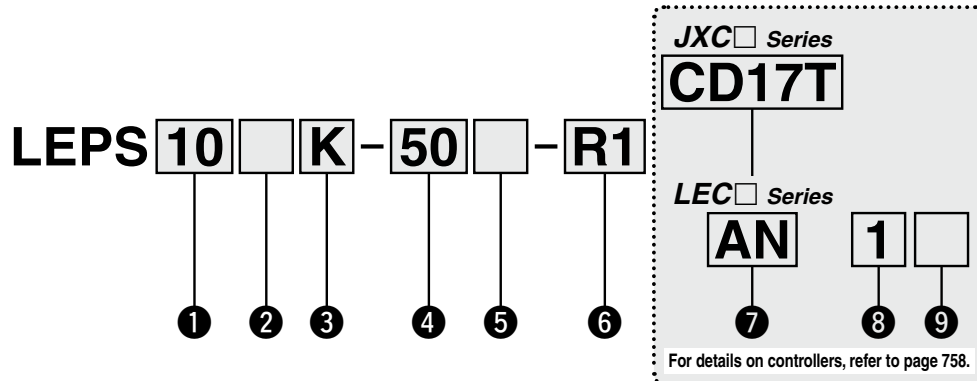

① Size

6
10

② Motor size

Symbol	Motor size	Applicable size
Nil	Basic	6, 10
L	Compact	10

③ Lead screw type [mm]

Symbol	Screw lead	
	LEPS6	LEPS10
K	4	5
J	8	10

④ Stroke [mm]

Symbol	Stroke
25	25
50	50

⑤ Motor cable mounting direction

Nil	Top entry 	L	Entry on the left side
	Bottom entry 		Entry on the right side
U		R	

⑥ Actuator cable type/length*2

Standard cable [m]		Robotic cable [m]			
Nil	None	R1	1.5	RA	10*1
S1	1.5	R3	3	RB	15*1
S3	3	R5	5	RC	20*1
S5	5	R8	8*1		



JXC Series (For details, refer to page 759.)

7 Controller

Nil	Without controller
C□1□□	With controller

C D 1 7 T

Interface (Communication protocol/Input/Output)

Symbol	Type	Number of axes, Special specification	
		Standard	With STO sub-function
5	Parallel input (NPN)	●	
6	Parallel input (PNP)	●	
E	EtherCAT	●	●
9	EtherNet/IP™	●	●
P	PROFINET	●	●
D	DeviceNet®	●	
L	IO-Link	●	●
M	CC-Link	●	

Mounting

7	Screw mounting
8*7	DIN rail

Number of axes, Special specification

Symbol	Number of axes	Specification
1	Single axis	Standard
F	Single axis	With STO sub-function

Communication plug connector, I/O cable*8

Symbol	Type	Applicable interface
Nil	Without accessory	—
S	Straight type communication plug connector	DeviceNet®
T	T-branch type communication plug connector	CC-Link Ver. 1.10
1	I/O cable (1.5 m)	Parallel input (NPN) Parallel input (PNP)
3	I/O cable (3 m)	
5	I/O cable (5 m)	

LEC Series (For details, refer to page 759.)

A N 1 □

7 8 9

7 Controller/Driver type*3

Nil	Without controller/driver	
1N	LECP1 (Programmable type)	NPN
1P		PNP
AN	LECPA *4 (Pulse input type)	NPN
AP		PNP

8 I/O cable length*5

Nil	Without cable (Without communication plug connector)	
1	1.5 m	
3	3 m*6	
5	5 m*6	

9 Controller/Driver mounting

Nil	Screw mounting
D	DIN rail*7



- *1 Produced upon receipt of order (Robotic cable only)
- *2 The standard cable should only be used on fixed parts.
For use on moving parts, select the robotic cable.
Refer to page 1092 if only the actuator cable is required.
- *3 For details on controllers/drivers and compatible motors, refer to the compatible controllers/drivers on the next page.
- *4 When pulse signals are open collector, order the current limiting resistor (LEC-PA-R-□) on page 1062 separately.
- *5 When "Without controller/driver" is selected for controller/driver types, I/O cable cannot be selected. Refer to page 1047 (For LECP1) or page 1062 (For LECPA) if an I/O cable is required.

- *6 When "Pulse input type" is selected for controller/driver types, pulse input usable only with differential. Only 1.5 m cables usable with open collector
- *7 The DIN rail is not included. It must be ordered separately.
- *8 Select "Nil" for anything other than DeviceNet®, CC-Link, or parallel input.
Select "Nil," "S," or "T" for DeviceNet® or CC-Link.
Select "Nil," "1," "3," or "5" for parallel input.

⚠ Caution

[CE/UKCA-compliant products]

① EMC compliance was tested by combining the electric actuator LEP series and the controller LEC/JXC series.
The EMC depends on the configuration of the customer's control panel and the relationship with other electrical equipment and wiring. Therefore, compliance with the EMC directive cannot be certified for SMC components incorporated into the customer's equipment under actual operating conditions. As a result, it is necessary for the customer to verify compliance with the EMC directive for the machinery and equipment as a whole.

[UL-compliant products (For the LEC series)]

When compliance with UL is required, the electric actuator and controller/driver should be used with a UL1310 Class 2 power supply.

The actuator and controller/driver are sold as a package.

Confirm that the combination of the controller/driver and the actuator is correct.

<Check the following before use.>

- ① Check the actuator label for the model number. This number should match that of the controller/driver.
- ② Check that the Parallel I/O configuration matches (NPN or PNP).

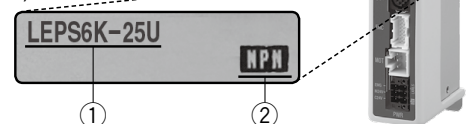













* Refer to the Operation Manual for using the products. Please download it via our website: <https://www.smcworld.com>

LEPS Series

Incremental (Step Motor 24 VDC)

Compatible Controllers/Drivers

Type	Step data input type 	Programless type 	Pulse input type 
Series	JXC51 JXC61	LECP1	LECPA
Features	Parallel I/O	Capable of setting up operation (step data) without using a PC or teaching box	Operation by pulse signals
Compatible motor	Step motor (Servo/24 VDC)		
Max. number of step data	64 points	14 points	—
Power supply voltage	24 VDC		
Reference page	1017	1042	1057

Type	EtherCAT direct input type 	EtherCAT direct input type with STO sub-function 	EtherNet/IP™ direct input type 	EtherNet/IP™ direct input type with STO sub-function 	PROFINET direct input type 	PROFINET direct input type with STO sub-function 	DeviceNet® direct input type 	IO-Link direct input type 	IO-Link direct input type with STO sub-function 	CC-Link direct input type 
Series	JXCE1	JXCEF	JXC91	JXC9F	JXCP1	JXC PF	JXCD1	JXCL1	JXCLF	JXCM1
Features	EtherCAT direct input	EtherCAT direct input with STO sub-function	EtherNet/IP™ direct input	EtherNet/IP™ direct input with STO sub-function	PROFINET direct input	PROFINET direct input with STO sub-function	DeviceNet® direct input	IO-Link direct input	IO-Link direct input with STO sub-function	CC-Link direct input
Compatible motor	Step motor (Servo/24 VDC)									
Max. number of step data	64 points									
Power supply voltage	24 VDC									
Reference page	1063									

Specifications



Weight

Model		LEPS6	
Stroke [mm]		25	50
Product weight [kg]	Basic	0.29	0.35

Model		LEPS10	
Stroke [mm]		25	50
Product weight [kg]	Basic	0.56	0.65
	Compact	0.50	0.59

Model		LEPS6		LEPS10		
Screw lead [mm]		4	8	5	10	
Pushing force [N] ^{*1 *6}		Basic	14 to 20	7 to 10	25 to 50	
		Compact	—	—	24 to 40	
Work load [kg] ^{*2 *3 *6}		Horizontal	Basic	1.0	0.75	2.0
			Compact	—	—	2.0
		Vertical	Basic	0.5	0.25	1.5
			Compact	—	—	1.5
Speed [mm/s] ^{*3 *6}		Horizontal	Basic	10 to 150	20 to 300 ^{*4}	10 to 200
			Compact	—	—	10 to 200
		Vertical	Basic	10 to 150	20 to 300 ^{*4}	10 to 150
			Compact	—	—	10 to 150
Pushing speed [mm/s] ^{*5}		10	20	10	20	
Acceleration/Deceleration [mm/s ²]		3000				
Backlash [mm]		0.2 or less				
Positioning repeatability [mm]		±0.05				
Lost motion [mm] ^{*7}		0.2 or less				
Impact/Vibration resistance [m/s ²] ^{*8}		50/20				
Actuation type		Slide screw				
Guide type		Linear guide				
Max. operating frequency [c.p.m]		60				
Operating temperature range [°C]		5 to 40				
Operating humidity range [%RH]		90 or less (No condensation)				
Enclosure		IP40				
Motor size		□20		□28		
Motor type		Step motor (Servo/24 VDC)				
Encoder (Angular displacement sensor)		Incremental				
Power supply voltage [V]		24 VDC ±10%				
Power [W] ^{*9}		Basic	Max. power 22		Max. power 55	
		Compact	—		Max. power 45	

*1 Pushing force accuracy is LEPS6: ±30% (F.S.), LEPS10: ±25%(F.S.).

Refer to pages 764 and 765 for the detailed setting range and precautions. The pushing force and the duty ratio change according to the set value. Check the "Pushing Force Set Value–Force Graph (Guide)" on page 753 and [14] on page 765.

*2 The maximum value of the work load for the positioning operation. Check the "Dynamic Allowable Moment" graph for the allowable moment of the guide on pages 754 and 755.

*3 Speed changes according to the work load. Check the "Speed–Work Load Graph (Guide)" on page 753.

*4 When the stroke is 25 mm, the maximum speed will be 250 mm/s.

*5 Set to the pushing speed when pushing operation.

*6 The speed and force may change depending on the cable length, load and mounting conditions. Furthermore, if the cable length exceeds 5 m, then it will decrease by up to 10% for each 5 m. (At 15 m: Reduced by up to 20%)

*7 A reference value for correcting errors in reciprocal operation

*8 Impact resistance: No malfunction occurred when the actuator was tested with a drop tester in both an axial direction and a perpendicular direction to the lead screw. (The test was performed with the actuator in the initial state.)

Vibration resistance: No malfunction occurred in a test ranging between 45 to 2000 Hz. The test was performed in both an axial direction and a perpendicular direction to the lead screw. (The test was performed with the actuator in the initial state.)

*9 Indicates the max. power during operation (including the controller)

This value can be used for the selection of the power supply.

Construction

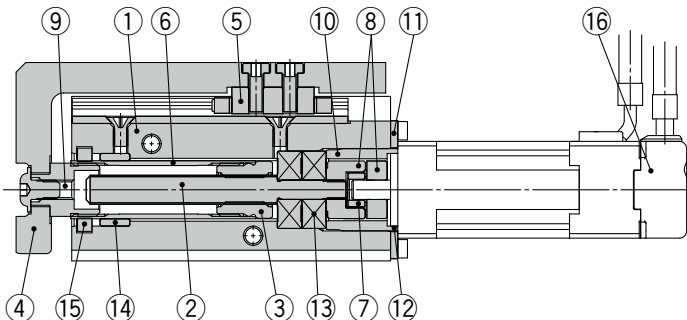

Component Parts

No.	Description	Material	Note
1	Body	Aluminum alloy	Anodized
2	Screw shaft	Stainless steel	Heat treatment + Special treatment
3	Screw nut	Stainless steel	Heat treatment + Special treatment
4	Table	Aluminum alloy	Anodized
5	Linear guide	—	
6	Rod	Stainless steel	
7	Spider	NBR	
8	Hub	Aluminum alloy	
9	Socket	Free cutting carbon steel	Nickel plating
10	Bearing stopper	Size 6: Aluminum alloy Size 10: Carbon steel	
11	Motor plate	Aluminum alloy	Anodized
12	Guide ring	Aluminum alloy	Size 10 only
13	Bearing	—	
14	Bushing	Bearing alloy	
15	Soft wiper	—	
16	Motor	—	

LEPS Series

Incremental (Step Motor 24 VDC)

Dimensions

LEPS6

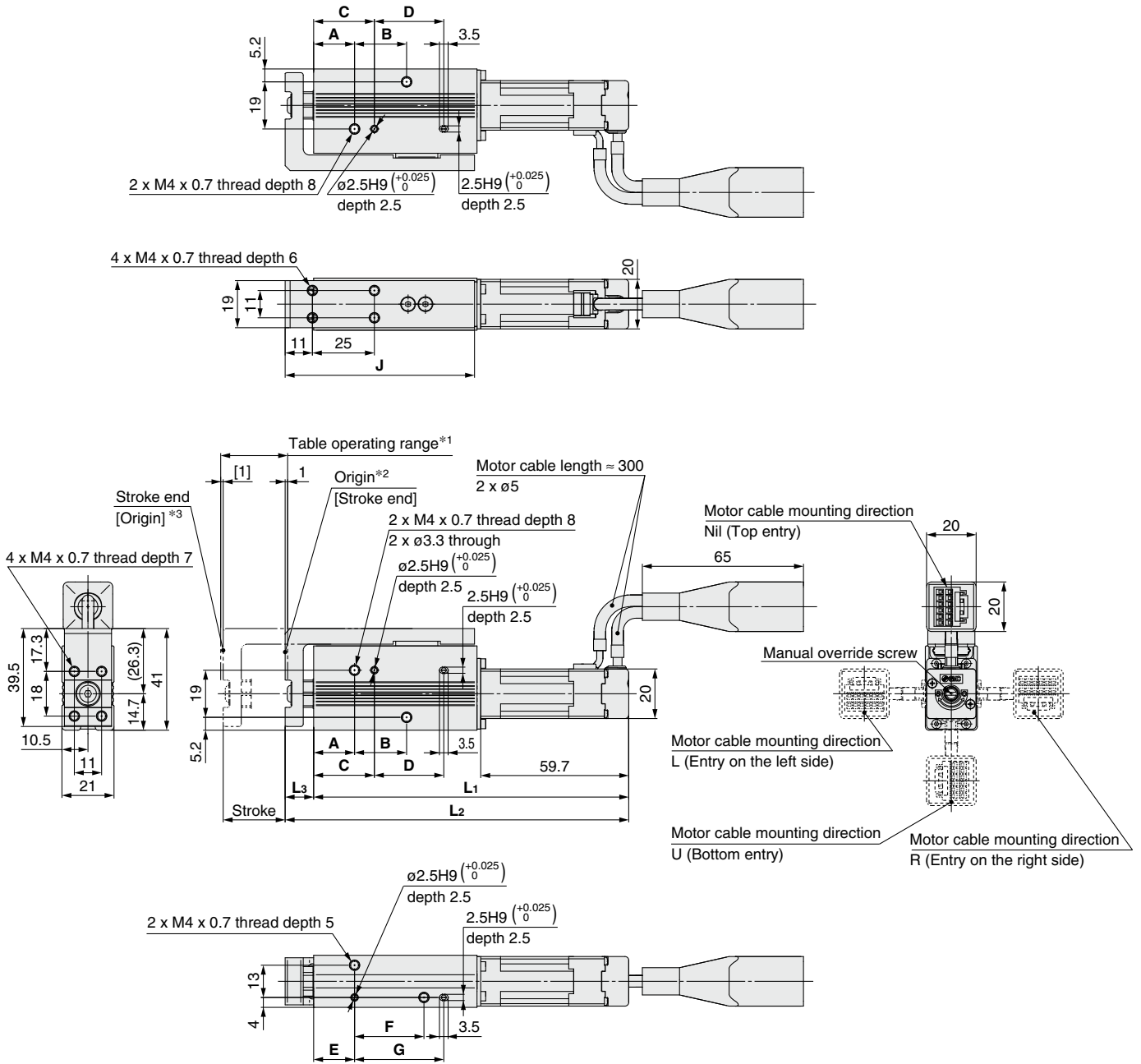

*1 This is the range within which the table can move when it returns to origin.

Make sure that workpieces mounted on the table do not interfere with other workpieces or the facilities around the table.

*2 Position after returning to origin

*3 [] for when the direction of return to origin has changed

Dimensions

[mm]

Model	L1	L2	L3	A	B	C	D	E	F	G	J
LEPS6□-25□	127.1	138.6	11.5	16.5	21	24.5	28	16.5	28	36	76.4
LEPS6□-50□	156.6	169.6	13	22	45	30	52	22	52	60	107.4

Dimensions

LEPS10

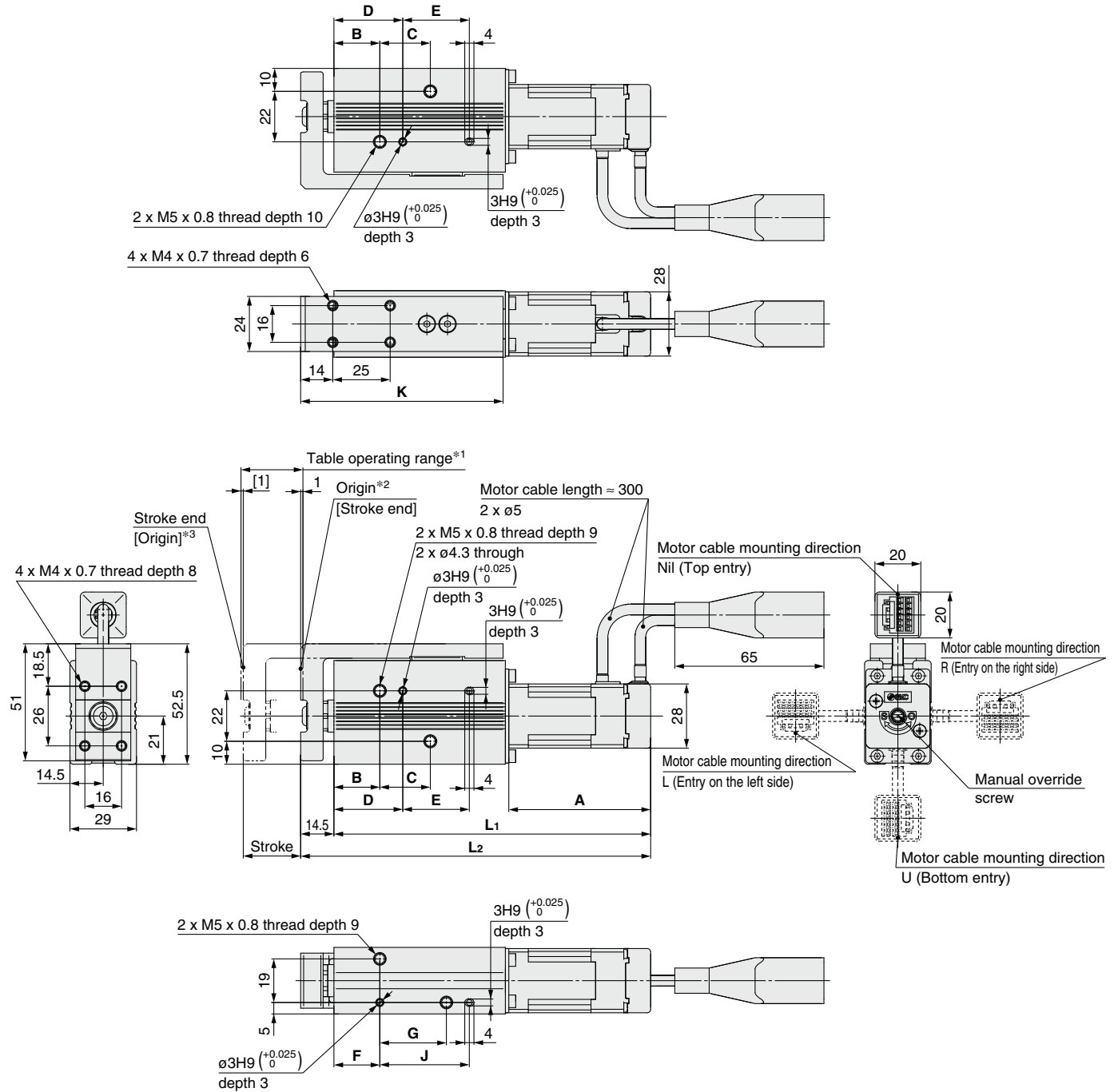

*1 This is the range within which the table can move when it returns to origin.

Make sure that workpieces mounted on the table do not interfere with other workpieces or the facilities around the table.

*2 Position after returning to origin

*3 [] for when the direction of return to origin has changed

Dimensions

[mm]

Model	L1	L2	A	B	C	D	E	F	G	J	K
LEPS10□-25□	138	152.5	61.8	20	22	30	29	20	29	39	88.2
LEPS10□-50□	163	177.5		24	43	34	50	24	50	60	113.2
LEPS10L□-25□	124	138.5	47.8	20	22	30	29	20	29	39	88.2
LEPS10L□-50□	149	163.5		24	43	34	50	24	50	60	113.2



LEPY/LEPS Series

Specific Product Precautions 1

Be sure to read this before handling the products. Refer to page 1351 for safety instructions and pages 1352 to 1357 for electric actuator precautions.

Design / Selection

Warning

- Do not apply a load in excess of the specification limits.**
Select a suitable actuator by work load and allowable lateral load on the rod end. If the product is used outside of the specification limits, the eccentric load applied to the rod will be excessive and have adverse effects such as the generation of play on the sliding parts of the rod, reduced accuracy, or reduced service life of the product may occur.
- Do not use the product in applications where excessive external force (including vibration) or impact force is applied to it.**
Do not apply impact and vibration outside of the specifications. This can cause a malfunction.
- If gravity acts on the workpiece due to vertical mounting, it may drop due to its own weight depending on the conditions when the product is not energized (SVON signal is OFF) or stopped (EMG is not energized).**
- Power failure may result in a decrease in the pushing force; ensure that safety measures are in place to prevent injury to the operator or damage to the equipment.**
When the product is used for clamping, the clamping force could be decreased due to power failure, potentially creating a hazardous situation in which the workpiece is released.
- This product cannot be used as a stopper.**
Excessive load acts on the actuator, which adversely affects the operation and the life of the product.

Mounting

Warning

- Do not drop or hit the actuator to avoid scratching and denting the mounting surfaces.**
Even a slight deformation can cause the deterioration of accuracy and operation failure.
- When mounting workpieces or attachments to the rod end, hold the flats of the rod end with a wrench so that the rod does not rotate (Rod type only).**
When attaching a nut or workpiece to the end of the rod, hold the flats of the rod end with a wrench (the rod should be fully retracted). Do not apply tightening torque to the rod non-rotating mechanism. The rod is manufactured to precise tolerances, so even a slight deformation may cause a malfunction and damage.

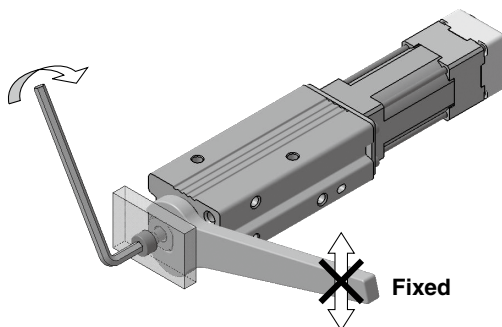

Mounting

Warning

- When mounting a bolt, workpieces, or attachment to the rod end, the bolt should be tightened with a torque within the specified range (Rod type only).**
Tightening to a torque higher than the specified value may cause a malfunction due to the deformation of the component, whilst under-tightening can cause displacement of the mounting position or in extreme conditions detaching of the workpiece. If the bolt is screwed in more than the maximum depth, the lead screw will be damaged, leading to operation failure.

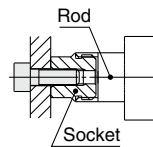

Model	Thread size	Max. tightening torque [N·m]	Max. screw-in depth [mm]	Rod end width across flats [mm]
LEPY6	M4 x 0.7	1.4	7	10
LEPY10	M5 x 0.8	3.0	9	12

- The angular position of the rod end flats cannot be changed because the rod has a non-rotating mechanism inside (Rod type only).**
The angular position of the rod end flats is not specified; it depends on the actuator type.
The rod rotates slightly due to the clearance of the non-rotating mechanism: Install the bolt or workpiece with consideration to the rotation.
- When attaching the workpiece to the table, hold the table and tighten the screws with a torque within the specified range (Slide table type only).**
The table is supported by a linear guide, do not apply impact or moment when mounting the work load.
If the screws are screwed to more than the maximum screw-in depth, it may lead to a malfunction due to damage of the linear guide or body.

Top mounting

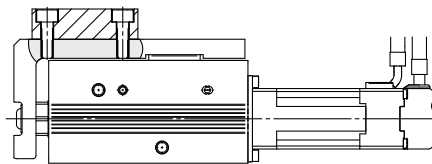

Model	Screw size	Max. tightening torque [N·m]	Max. screw-in depth [mm]
LEPS6	M4 x 0.7	1.4	6
LEPS10	M4 x 0.7	1.4	6

Front mounting

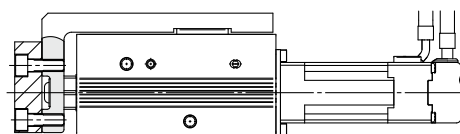

Model	Screw size	Max. tightening torque [N·m]	Max. screw-in depth [mm]
LEPS6	M4 x 0.7	1.4	7
LEPS10	M4 x 0.7	1.4	8



LEPY/LEPS Series

Specific Product Precautions 2

Be sure to read this before handling the products. Refer to page 1351 for safety instructions and pages 1352 to 1357 for electric actuator precautions.

Mounting

Warning

6. When mounting the product, tighten the mounting screws within the specified torque range.

Tightening the screws with a higher torque than recommended may result in a malfunction, while tightening with a lower torque can result in the displacement of the mounting position or, in extreme conditions, the actuator could become detached from its mounting position.

Side mounting (Body mounting through-hole)

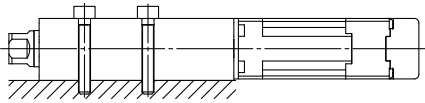

Model	Screw size	Max. tightening torque [N·m]
LEPY6	M3 x 0.5	0.9
LEPS6		
LEPY10	M4 x 0.7	1.4
LEPS10		

Side mounting (Body tapped)

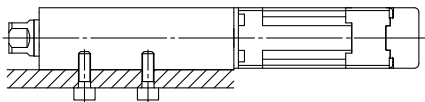

Model	Screw size	Max. tightening torque [N·m]	Max. screw-in depth [mm]
LEPY6	M4 x 0.7	1.4	7
LEPS6			
LEPY10	M5 x 0.8	3.0	9
LEPS10			

Bottom mounting (Body tapped)

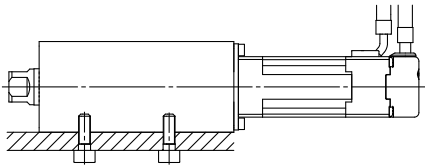

Model	Screw size	Max. tightening torque [N·m]	Max. screw-in depth [mm]
LEPY6	M4 x 0.7	1.4	5
LEPS6			
LEPY10	M5 x 0.8	3.0	9
LEPS10			

Rod side mounting (Rod type only)

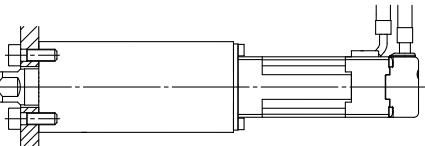

Model	Screw size	Max. tightening torque [N·m]	Max. screw-in depth [mm]
LEPY6	M4 x 0.7	1.4	7
LEPY10	M5 x 0.8	3.0	9

7. When it is necessary to operate the product by the manual override screw, check the position of the manual override and leave necessary space.

Do not apply excessive torque to the manual override screw. Failure to do so may result in damage or malfunction.

8. When an external guide is used, connect it in such a way that no impact or load is applied to it.

This may cause a malfunction due to an increase in sliding resistance, or use a freely moving connector (such as a floating joint).

Handling

Caution

1. To conduct a pushing operation, be sure to set the product to [Pushing operation].

Do not allow a workpiece to collide with the rod/table during the positioning operation or within the positioning range.

Failure to do so may result in damage lead to or malfunction. If the operation is interrupted or stopped during the cycle: When the pushing operation command is output immediately after restarting the operation, the direction of movement depends on the position of restart.

2. Use the product within the specified pushing speed range for the pushing operation.

Failure to do so may result in damage or malfunction.

Model	Lead	Pushing speed [mm/s]
LEPY6	4	10
LEPS6	8	20
LEPY10	5	10
LEPS10	10	20

3. For pushing operations, ensure that the force is applied in the direction of the rod axis.

4. The moving force should be the initial value.

If the moving force is set below the initial value, it may cause the generation of an alarm.

Model	Motor size	Moving force [%]
LEPY6	Basic	150
LEPS6		
LEPY10	Basic	150
LEPS10	Compact	

5. The actual speed of this actuator is affected by the load.

Check the model selection section of the catalog.

6. Do not scratch or dent the sliding parts of the rod, by striking or attaching objects.

The rod is manufactured to precise tolerances, even a slight deformation may cause a malfunction.

7. Avoid using the electric actuator in such a way that rotational torque would be applied to the rod.

It may cause deformation of the non-rotating sliding part, leading to clearance in the internal guide or an increase in the sliding resistance. Refer to the table below for the approximate values of the allowable range of rotational torque.

Allowable rotational torque [N·m] or less	LEPY6□	LEPY10□
	0.04	0.08



LEPY/LEPS Series

Specific Product Precautions 3

Be sure to read this before handling the products. Refer to page 1351 for safety instructions and pages 1352 to 1357 for electric actuator precautions.

Handling

⚠ Caution

8. Do not operate by fixing the rod and moving the actuator body.

Excessive load will be applied to the rod, leading to damage to the actuator and reduced the life of the product.

9. Return to origin

- 1) Do not apply a load, impact, or resistance in addition to the transferred load during return to origin. Additional force will cause the displacement of the origin position since it is based on the detected motor torque.
- 2) When the return to origin is set with <Basic parameter> [Origin offset], it is necessary to change the current position of the product. Recheck the value of step data.
- 3) It is recommended to set the directions of return to origin and pushing in the same direction in order to enhance the measurement accuracy during the pushing operation.

10. There is no backlash effect in the pushing operation.

The return to origin is done by the pushing operation. The position can be displaced by the effect of the backlash during the positioning operation. Take the backlash into consideration when setting the position.

<Backlash>

Model	Backlash [mm]
LEPY6	0.2 or less
LEPS6	0.2 or less
LEPY10	0.2 or less
LEPS10	0.2 or less

11. Never allow the rod/table to collide with the stroke end except during return to origin.

This may damage the inner parts.

12. INP output signal

- 1) Positioning operation
When the product comes within the set range of the step data [In position], the INP output signal will turn ON.
Initial value: Set to [0.50] or higher.
- 2) Pushing operation
When the effective pushing force exceeds the step data [Trigger LV], the INP output signal will turn ON.
When [Pushing force] setting and [Trigger LV] are set less than [Pushing force], use the product within the specified range of the [Pushing force] and [Trigger LV].
 - a) To ensure that the actuator pushes the workpieces with the set [Pushing force], it is recommended that the [Trigger LV] be set to the same value as the [Pushing force].
 - b) If the [Trigger LV] is set lower than the [operation pushing force (current pushing force) for the pushing operation], the pushing force will exceed the trigger LV from the pushing start position and the INP output signal will turn ON before pushing the workpieces. Increase the pushing force, or change the work load so that the current pushing force becomes smaller than the trigger LV.

<Pushing force and trigger LV range>

Model	Motor size	Pushing force set value [%]
LEPY6 LEPS6	Basic	70 to 100
LEPY10 LEPS10	Basic	50 to 100
	Compact	60 to 100

13. For pushing operations, set the product to a position at least 0.5 mm away from a workpiece. (This position is referred to as the pushing start position.)

The following alarms may be generated and operation may become unstable if setting is not done correctly.

a. "Posn failed"

The product cannot reach the pushing start position due to variations in the width of workpieces.

b. "Pushing ALM"

The product is pushed back from the pushing start position after starting to push.

c. "Deviation over flow"

Displacement exceeding the specified value is generated at the pushing start position.

14. For pushing operations, use the product within the duty ratio range below.

The duty ratio is the fraction of time that the product can keep pushing.

Model	Motor size	Pushing force set value [%]	Duty ratio [%]	Continuous pushing time [min]
LEPY6 LEPS6	Basic	70	100	No restriction
		80	70	10 or less
		100	50	5 or less

Model	Motor size	Pushing force set value [%]	Duty ratio [%]	Continuous pushing time [min]
LEPY10 LEPS10	Basic	60 or less	100	No restriction
		70	30	3 or less
		100	15	1 or less

Model	Motor size	Pushing force set value [%]	Duty ratio [%]	Continuous pushing time [min]
LEPY10 LEPS10	Compact	70 or less	100	No restriction
		80	70	10 or less
		100	50	5 or less

15. When mounting the product, secure a bending diameter of 40 mm or longer for the motor cable.

Maintenance

⚠ Warning

1. Ensure that the power supply is stopped and the workpiece is removed before starting maintenance work or replacing the product.