

Series 10-SY3000/5000/7000/9000

5 Port Solenoid Valve

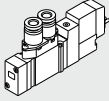

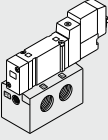

Valve Variations

	Series	Sonic conductance C [dm ³ /(s·bar)] { 4/2→5/3 (A/B→EA/EB)}	Actuation					Voltage		Electrical entry				Light/surge voltage suppressor	Directional Control Valves	
			2 position		3 position			DC	AC	Grommet	L plug connector	M plug connector	DIN terminal			M8 connector
			Single	Double	Closed center	Exhaust center	Pressure center									
Body ported	P.43 	10-SY3□20	0.65	●	●	●	●	●	●	●	●	●	●	●	Air Actuators	
		10-SY5□20	2.4	●	●	●	●	●	●	●	●	●	●	●		Rotary Actuators
		10-SY7□20	3.3	●	●	●	●	●	●	●	●	●	●	●		
		10-SY9□20	8.6	●	●	●	●	●	●	●	●	●	●	●		
Base mounted	P.58 	10-SY3□40	1.1	●	●	●	●	●	●	●	●	●	●	●	Air Grippers	
		10-SY5□40	2.8	●	●	●	●	●	●	●	●	●	●	●		Air Preparation Equipment
		10-SY7□40	4.5	●	●	●	●	●	●	●	●	●	●	●		
		10-SY9□40	10	●	●	●	●	●	●	●	●	●	●	●		

Series	Manual override	Non-locking push type	Push-turn locking slotted type	Push-turn locking lever type	Bracket	P, EA, EB port size						A, B port size						Valve option										
						M5	1/8	1/4	3/8	1/2	M5	1/8	1/4	3/8	1/2	One-touch fitting						Exhaust throttle	Orissanair (Other than designated, turbine oil)	Vacuum specifications	Low pressure specifications	Dual pressure	Enclosure IP65	
																C4	C6	C8	C10	C12	N3							N7
Body ported	10-SY3□20	●	●	●	●	—	—	—	—	—	●	—	—	—	—	●	—	—	—	—	●	▲	—	—	—	—	Pressure Control Equipment	
	10-SY5□20	●	●	●	●	—	—	—	—	—	●	—	—	—	—	●	—	—	—	—	—	—	—	—	—	—		Fittings & Tubing
	10-SY7□20	●	●	●	●	—	—	—	—	—	●	—	—	—	—	●	—	—	—	—	—	—	—	—	—	—		
	10-SY9□20	●	●	●	●	—	—	—	—	—	●	—	—	—	—	●	—	—	—	—	—	—	—	—	—	—		
Base mounted	10-SY3□40	●	●	●	—	●	—	—	—	—	—	●	—	—	—	—	—	—	—	—	—	—	—	—	—	—	Flow Control Equipment	
	10-SY5□40	●	●	●	—	—	●	—	—	—	—	—	●	—	—	—	—	—	—	—	—	—	—	—	—	—		
	10-SY7□40	●	●	●	—	—	—	●	—	—	—	—	—	●	—	—	—	—	—	—	—	—	—	—	—	—		
	10-SY9□40	●	●	●	—	—	—	—	●	—	—	—	—	—	●	—	—	—	—	—	—	—	—	—	—	—		

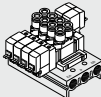
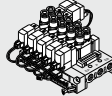
● Standard ● Option ▲ Made to order (Refer to page "Made to Order")
 Note 1) All AC voltage models have built-in surge voltage suppressor.
 Note 2) Body ported external pilot type (made to order) is not available for DIN terminal.
 Note 3) Only available for DIN terminal and M8 connector.
 Note 4) 10-SY3000 does not have a DIN terminal which can be connected to a manifold.

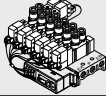
Manifold Variations

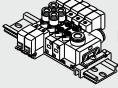
Manifold Variations				Valve Series	Wiring									
					Connection							Common specifications		
					Individual wiring	Flat ribbon cable (26 pins)	Flat ribbon cable (20 pins) connector box	Plug-in type D-sub connector (25 pins)	Plug-in type flat ribbon cable (26, 20, 10 pins)	Plug-in type terminal block (9, 18 pins)	Serial transmission unit	Positive common	Negative common	
Body ported	Bar stock type Individual wiring ■ Direct piping to the main unit of a valve. Combination of different fittings is possible.		Type 20 P. 73	10-SY3□20	●	—	—	—	—	—	—	—	—	
			10-SY5□20	—	●	—	—	—	—	—	—	—		
			10-SY7□20	—	—	—	—	—	—	—	—			
	Bar stock type Flat ribbon cable ■ A 26 pin MIL connector permits one-touch wiring of external cables in a bundle.		Type 20P P. 83	10-SY3□20	—	●	—	—	—	—	—	● (Note)	—	
			10-SY5□20	—	●	—	—	—	—	—	—	● (Note)		
			10-SY7□20	—	—	—	—	—	—	—	—	● (Note)		
	Stacking type Individual wiring ■ Manifold stations can be increased or decreased.		Type 23 P. 79	10-SY9□20	●	—	—	—	—	—	—	—	—	
			Type 23P P. 89	10-SY9□20	—	●	—	—	—	—	—	—	● (Note)	—
			10-SY9□20	—	●	—	—	—	—	—	—	—	● (Note)	
	Bar stock type EX510 gateway type ■ Can be used with a serial transmission system.		Type 20SA P. 92	10-SY3□20	—	—	—	—	—	—	—	●	—	
10-SY5□20			—	—	—	—	—	—	—	—	●	—		
10-SY7□20			—	—	—	—	—	—	—	—	●	—		
Stacking type EX510 gateway type ■ Can be used with a serial transmission system.		Type 23SA P. 97	10-SY9□20	—	—	—	—	—	—	—	●	—		
		10-SY9□20	—	—	—	—	—	—	—	—	●	—		
Cassette type Individual wiring ■ Size and weight reduced by eliminating the manifold base.		Type 60 P. 104	10-SY3□60	●	—	—	—	—	—	—	—	—		
		10-SY5□60	●	—	—	—	—	—	—	—	—	—		
		10-SY7□60	●	—	—	—	—	—	—	—	—	—		

● Standard ○ Option ▲ Made to order (Refer to page "Made to Order".)
 (Note) When there are polarities, the positive common specifications are used.

Manifold Variations

Manifold Variations		Valve Series		Wiring						
				Connection				Common specifications		
				Individual wiring	Flat ribbon cable (26 pins)	Flat ribbon cable (20 pins) connector box	Serial transmission unit	Positive common	Negative common	
		5 port								
Base mounted	Compact bar stock type Individual wiring ■ The base mounting facilitates maintenance after valves are changed.		Type 41 P. 118	10-SY3□40	●	—	—	—	—	—
	Compact bar stock type Flat ribbon cable ■ A 26 pin MIL connector permits one-touch wiring of external cables in a bundle.		Type 41P P. 134	10-SY3□40 10-SY5□40	—	●	—	—	● (Note) In common	
	Bar stock type/Common external pilot Individual wiring ■ The base mounting facilitates maintenance after valves are changed. ■ Vacuum/low pressure combination system is possible.		Type 42 P. 118	10-SY3□40 10-SY5□40 10-SY7□40	●	—	—	—	—	—
	Bar stock type/Common external pilot Flat ribbon cable ■ A 26 pin MIL connector permits one-touch wiring of external cables in a bundle. ■ Vacuum/low pressure combination system is possible.		Type 42P P. 134	10-SY3□40 10-SY5□40 10-SY7□40	—	●	—	—	● (Note) In common	
	Stacking type Individual wiring ■ Manifold stations can be increased or decreased.		Type 43 P. 128	10-SY9□40	●	—	—	—	—	—
	Stacking type Flat ribbon cable ■ Manifold stations can be increased or decreased.		Type 43P P. 142	10-SY9□40	—	●	—	—	● (Note) In common	
	Stacking type/DIN rail mounted Individual wiring ■ Stations can be increased on the DIN rail. Integral mounting of other electric parts is possible, too.		Type 45 P. 150	10-SY3□40 10-SY5□40	●	—	—	—	—	—
	Stacking type/DIN rail mounted Connector box ■ Stations can be increased or decreased on the DIN rail. The provided connector box permits one-touch connection of electric cables.		Type 45^A_{NA} P. 157	10-SY3□40 10-SY5□40	—	—	●	—	●	●

● Standard ○ Option ▲ Made to order (Refer to page "Made to Order".)
 (Note) When there are polarities, the positive common specifications are used.

Manifold option					A, B port size											Valve option																						
Blanking plate	Individual SUP spacer	Individual EXH spacer	SUP block disk	EXH block disk	Label for block disk	Connector	M5	1/8	1/4	3/8	One-touch fitting								Mixed mounting <small>10-SY3000 10-SY5000</small>	Oil resistant (Other than designated turbine oil)	Vacuum specifications	Low pressure specifications	Different pressure	Dual pressure	Exhaust throttle	Bundle wiring	Mixed fitting sizes	IP65 enclosure										
											C4	C6	C8	C10	C12	N3	N7	N9											N11									
●	●	●	—	—	—	—	●	—	—	—	●	●	—	—	—	●	●	—	—	—	—	●	—	—	—	—	—	—	—	—	—	—	—	●	●			
●	●	●	—	—	—	—	●	—	—	—	●	●	—	—	—	●	●	—	—	—	—	●	—	—	—	—	—	—	—	—	—	—	—	—	—	●	●	
●	●	●	—	—	—	—	—	—	—	—	●	●	—	—	—	—	—	—	—	—	—	—	—	—	—	—	—	—	—	—	—	—	—	—	—	●	●	
●	●	●	—	—	—	—	—	—	—	—	—	—	—	—	—	—	—	—	—	—	—	—	—	—	—	—	—	—	—	—	—	—	—	—	—	●	●	
●	●	●	●	●	●	—	—	—	—	—	—	—	—	—	—	—	—	—	—	—	—	—	—	—	—	—	—	—	—	—	—	—	—	—	—	—	●	●
●	●	●	●	●	●	—	—	—	—	—	—	—	—	—	—	—	—	—	—	—	—	—	—	—	—	—	—	—	—	—	—	—	—	—	—	—	●	●
●	●	●	●	●	●	—	—	—	—	—	—	—	—	—	—	—	—	—	—	—	—	—	—	—	—	—	—	—	—	—	—	—	—	—	—	—	●	●
●	●	●	●	●	●	—	—	—	—	—	—	—	—	—	—	—	—	—	—	—	—	—	—	—	—	—	—	—	—	—	—	—	—	—	—	—	●	●
●	●	●	●	●	●	—	—	—	—	—	—	—	—	—	—	—	—	—	—	—	—	—	—	—	—	—	—	—	—	—	—	—	—	—	—	—	●	●

Note) When using DIN terminal or M8 connector. 10-SY3000 does not have a DIN terminal which can be connected to a manifold.

Directional Control Valves

Air Cylinders

Rotary Actuators

Air Grippers

Air Preparation Equipment

Modular F. R.

Pressure Control Equipment

Fittings & Tubing

Flow Control Equipment

Pressure Switches/ Pressure Sensors

Series 10-SY3000/5000/7000/9000

5 Port Solenoid Valve Body Ported/Single Unit



[Option]
Note) AC-type models that are CE-compliant have DIN terminals only.

How to Order

10 - SY 5 1 20 - 5 L - 01 - - - -

Clean series

Series

3	10-SY3000
5	10-SY5000
7	10-SY7000
9	10-SY9000

Actuation type

1	2 position single (A)4 2(B) (EA)5 1 3(EB) (P)
2	2 position double (A)4 2(B) (EA)5 1 3(EB) (P)
3	3 position closed center (A)4 2(B) (EA)5 1 3(EB) (P)
4	3 position exhaust center (A)4 2(B) (EA)5 1 3(EB) (P)
5	3 position pressure center (A)4 2(B) (EA)5 1 3(EB) (P)

Coil type

Nil	Standard
T	With power saving circuit (24, 12 VDC only)

* Power saving circuit is not available for D, DO, Y, YO or W□ types.

For DC

5	24 VDC
6	12 VDC
V	6 VDC
S	5 VDC
R	3 VDC

Rated voltage

For AC (50/60 Hz)	
1	100 VAC
2	200 VAC
3	110 VAC [115 VAC]
4	220 VAC [230 VAC]

* DC specifications of type D, Y, DO and YO are only available with 12 and 24 VDC.

* For type W□, only DC voltage is available.
Note) AC-type models that are CE-compliant have DIN terminals only.

Note) For details about Symbol of the 3 position type 10-SY9000 series, refer to the SY series of the WEB catalog.

Electrical entry

	24, 12, 6, 5, 3 VDC/100, 110, 200, 220 VAC	24, 12 VDC/100, 110, 200, 220 VAC				
	Grommet	M plug connector	DIN terminal			
	G: Lead wire length 300 mm 	L: With lead wire (Length 300 mm) 	M: With lead wire (Length 300 mm) 	MN: Without lead wire 	D, Y: With connector 	DO, YO: Without connector
	H: Lead wire length 600 mm 	LN: Without lead wire 	LO: Without connector 	MO: Without connector 		
CE-compl. ant.	DC	●	●	●	●	●
	AC	●	●	●	●	●

M8 connector

W□: Without connector cable



W□: With connector cable

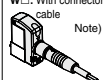

Note)

- * LN, MN type: With 2 sockets.
- * For DIN terminal of the 10-SY3000 series, refer to page 174.
- * "Y" type is a DIN terminal conforming to EN-175301-803C (former DIN43650C). For details, refer to page 173.
- * For connector cable of M8 connector, refer to page 176.
- * M8 connector conforming to IEC60947-5-2 standard is also available. Refer to page 168 for details.
- * Refer to page 173 for the lead wire length of L and M plug connectors.
- * Refer to page 174 for the connector assembly with cover for L and M plug connectors.

Note) Enter the cable length symbols in □. Please be sure to fill in the blank referring to page 176.

A, B port size Thread piping

Symbol	Port size	Applicable series
M5	M5 x 0.8	10-SY3000
01	1/8	10-SY5000
02	1/4	10-SY7000
02	1/4	10-SY9000
03	3/8	10-SY9000

One-touch fitting (Metric size)

Symbol	Port size	Applicable series
C4	ø4 One-touch fitting	10-SY3000
C6	ø6 One-touch fitting	10-SY5000
C4	ø4 One-touch fitting	10-SY5000
C6	ø6 One-touch fitting	10-SY5000
C8	ø8 One-touch fitting	10-SY7000
C8	ø8 One-touch fitting	10-SY7000
C10	ø10 One-touch fitting	10-SY9000
C8	ø8 One-touch fitting	10-SY9000
C10	ø10 One-touch fitting	10-SY9000
C12	ø12 One-touch fitting	10-SY9000

One-touch fitting (Inch size)

Symbol	Port size	Applicable series
N3	ø 5/32 One-touch fitting	10-SY3000
N7	ø 1/4" One-touch fitting	10-SY5000
N3	ø 5/32 One-touch fitting	10-SY5000
N7	ø 1/4" One-touch fitting	10-SY5000
N9	ø 5/16 One-touch fitting	10-SY7000
N9	ø 5/16 One-touch fitting	10-SY7000
N11	ø 3/8" One-touch fitting	10-SY7000
N9	ø 5/16 One-touch fitting	10-SY9000
N11	ø 3/8" One-touch fitting	10-SY9000

Manual override

Nil: Non-locking push type 	D: Push-turn locking slotted type 	E: Push-turn locking lever type
--------------------------------	---------------------------------------	-------------------------------------

Light/Surge voltage suppressor

Electrical entry for G, H, L, M, W

Nil	Without light/surge voltage suppressor
S	With surge voltage suppressor
Z	With light/surge voltage suppressor
R	With surge voltage suppressor (Non-polar type)
U	With light/surge voltage suppressor (Non-polar type)

- * For AC voltage valves there is no "S" option. It is already built into the rectifier circuit.
- * For "R" and "U", only DC voltage is available.
- * Power saving circuit is only available for the "Z" type.

Electrical entry for D, Y

Nil	Without light/surge voltage suppressor
S	With surge voltage suppressor (Non-polar type)
Z	With light/surge voltage suppressor (Non-polar type)

- * DOZ and YOZ are not available.
- * For AC voltage valves there is no "S" option. It is already built into the rectifier circuit.

Note) When placing an order for body ported solenoid valves as a single unit, the mounting screws for the manifold and gasket are not attached. Order them separately, if necessary. (For details, refer to page 100.)

Bracket

Nil: Without bracket
F1: With foot bracket (2 position single only)



F2: With side bracket



* 10-SY9000 has no bracket.

Thread type

Nil	Rc
F	G
N	NPT
T	NPTF

* Except for M5

Made to Order

Nil	—
X90	Main valve fluorozinc (Refer to page 168.)

CE-compliant

Nil	—
Q	CE-compliant

Note) AC-type models that are CE-compliant have DIN terminals only.

Specifications

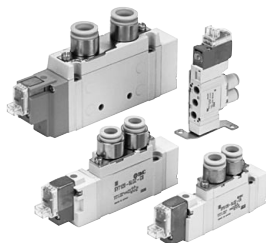

Series	10-SY3000	10-SY5000	10-SY7000	10-SY9000
Fluid	Air			
Internal pilot operating pressure range (MPa)	0.15 to 0.7			
2 position single	0.1 to 0.7			
2 position double	0.2 to 0.7			
3 position	0.2 to 0.7			
Ambient and fluid temperature (°C)	-10 to 50 (No freezing)			
Max. operating frequency (Hz)	10	5	5	5
2 position single, double	3	3	3	3
3 position	3	3	3	3
Manual override (Manual operation)	Non-locking push type, Push-turn locking slotted type, Push-turn locking lever type			
Pilot exhaust method	Main/Pilot valve common exhaust			
Lubrication	Not required			
Mounting orientation	Unrestricted			
Impact/Vibration resistance (m/s²)^{Note}	150/30			
Enclosure	Dust proof (* DIN terminal and M8 connector: IP65)			

* Based on IEC60529

Note) Impact resistance: No malfunction occurred when it was tested in the axial direction and at right angles to the main valve and armature in both energized and de-energized states once for each condition. (Default settings)

Vibration resistance: No malfunction occurred in a one-sweep test between 45 and 2000 Hz. Test was performed in both energized and de-energized states in the axial direction and at right angles to the main valve and armature. (Default settings)



Made to Order

(For details, refer to pages 166 to 169.)

Solenoid Specifications

Electrical entry		Grommet (G), (H)		DIN terminal (D), (Y)	
		L plug connector (L)		M8 connector (W)	
		G, H, L, M, W		D, Y	
Coil rated voltage (V)	DC	24, 12, 6, 5, 3		24, 12	
	AC 50/60 Hz	100, 110, 200, 220			
Allowable voltage fluctuation		±10% of rated voltage *			
Power consumption (W)	DC	Standard	0.35 (With indicator light: 0.4, DIN terminal with indicator light: 0.45)		
		With power saving circuit	0.1 (With indicator light only) * [Starting 0.4, Holding 0.1]		
Apparent power (VA) *	AC	100 V	0.78 (With indicator light: 0.81)	0.78 (With indicator light: 0.87)	
		110 V [115 V]	0.86 (With indicator light: 0.89)	0.86 (With indicator light: 0.97)	
		200 V	0.94 (With indicator light: 0.97)	0.94 (With indicator light: 1.07)	
		220 V [230 V]	1.18 (With indicator light: 1.22)	1.15 (With indicator light: 1.30)	
		1.30 (With indicator light: 1.34)	1.27 (With indicator light: 1.46)		
		1.42 (With indicator light: 1.46)	1.39 (With indicator light: 1.60)		
Surge voltage suppressor		Diode (Varistor is for DIN terminal and non-polar type.)			
Indicator light		LED (AC of DIN connector is neon light.)			

* Common between 110 VAC and 115 VAC, and between 220 VAC and 230 VAC.

* For 115 VAC and 230 VAC, the allowable voltage is -15% to +5% of rated voltage.

* DIN terminal and M8 connector with power saving circuit are not available.

* For details, refer to page 171.

Response Time

Note) Based on dynamic performance test, JIS B 8375-1981. (Coil temperature: 20°C, at rated voltage)

10-SY3000

Actuation type	Response time (ms) (at the pressure of 0.5 MPa)			
	Without light/surge voltage suppressor	With light/surge voltage suppressor		
		Type S, Z	Type R, U	
2 position single	12 or less	15 or less	12 or less	
2 position double	10 or less	13 or less	10 or less	
3 position	15 or less	20 or less	16 or less	

10-SY5000

Actuation type	Response time (ms) (at the pressure of 0.5 MPa)			
	Without light/surge voltage suppressor	With light/surge voltage suppressor		
		Type S, Z	Type R, U	
2 position single	19 or less	26 or less	19 or less	
2 position double	18 or less	22 or less	18 or less	
3 position	32 or less	38 or less	32 or less	

10-SY7000

Actuation type	Response time (ms) (at the pressure of 0.5 MPa)			
	Without light/surge voltage suppressor	With light/surge voltage suppressor		
		Type S, Z	Type R, U	
2 position single	31 or less	38 or less	33 or less	
2 position double	27 or less	30 or less	28 or less	
3 position	50 or less	56 or less	50 or less	

10-SY9000

Actuation type	Response time (ms) (at the pressure of 0.5 MPa)			
	Without light/surge voltage suppressor	With light/surge voltage suppressor		
		Type S, Z	Type R, U	
2 position single	35 or less	41 or less	35 or less	
2 position double	35 or less	41 or less	35 or less	
3 position	62 or less	64 or less	62 or less	

Directional Control Valves

Air Cylinders

Rotary Actuators

Air Grippers

Air Preparation Equipment

Modular F. R.

Pressure Control Equipment

Fittings & Tubing

Flow Control Equipment

Pressure Switches/Pressure Sensors

Flow Rate Characteristics/Weight

10-SY3000

Valve model	Actuation type	Port size		Flow rate characteristics						Weight (g)		
		1, 5, 3 (P, EA, EB)	4, 2 (A, B)	1→4/2 (P→A/B) C (dm ³ /s(bar))	b	Cv	4/2→5/3 (AB→EA/EB) C (dm ³ /s(bar))	b	Cv	Gro- mmet	L/M plug connector	W M8 connector
10-SY3000 -M5	2 position Single Double	M5 x 0.8		0.61	0.44	0.16	0.64	0.45	0.18	51	53	57
										68	74	82
	3 position Closed center Exhaust center Pressure center			0.48	0.46	0.13	0.47	0.43	0.13	71	76	84
				0.47	0.42	0.13	0.47	0.41	0.13	[0.44]	[0.37]	[0.12]
10-SY3000 -C4	2 position Single Double	M5 x 0.8	C4 ø4 (One-touch fitting)	0.72	0.29	0.18	0.64	0.34	0.17	60	63	67
										78	83	91
	3 position Closed center Exhaust center Pressure center			0.59	0.28	0.15	0.59	0.30	0.15	81	86	94
				0.63	0.35	0.16	0.42	0.34	0.11	[0.41]	[0.37]	[0.11]
10-SY3000 -C6	2 position Single Double	M5 x 0.8	C6 ø6 (One-touch fitting)	0.76	0.30	0.19	0.65	0.39	0.17	56	59	63
										74	79	87
	3 position Closed center Exhaust center Pressure center			0.76	0.55	0.24	0.60	0.33	0.16	77	82	90
				0.65	0.32	0.16	0.62	0.31	0.17	[0.42]	[0.36]	[0.11]
				0.77	0.34	0.21	0.61	0.34	0.16	[0.49]	[0.43]	[0.15]

Note) []: denotes normal position.

10-SY7000

Valve model	Actuation type	Port size		Flow rate characteristics						Weight (g)			
		1, 5, 3 (P, EA, EB)	4, 2 (A, B)	1→4/2 (P→A/B) C (dm ³ /s(bar))	b	Cv	4/2→5/3 (AB→EA/EB) C (dm ³ /s(bar))	b	Cv	Gro- mmet	L/M plug connector	DIN terminal	W M8 connector
10-SY7000 -C02	2 position Single Double	1/4		4.1	0.23	0.93	3.3	0.33	0.81	101	104	125	
										120	125	167	
	3 position Closed center Exhaust center Pressure center			2.9	0.31	0.70	2.4	0.38	0.63	128	133	175	141
				2.5	0.39	0.68	3.4	0.35	0.82	[12.1]	[0.38]	[0.82]	[0.54]
10-SY7000 -C08	2 position Single Double	1/4	C8 ø8 (One-touch fitting)	3.2	0.26	0.77	3.2	0.37	0.82	107	110	131	
										126	132	174	
	3 position Closed center Exhaust center Pressure center			2.6	0.24	0.63	2.4	0.31	0.62	134	140	182	148
				2.4	0.25	0.57	2.6	0.42	0.70	[2.4]	[0.22]	[0.57]	[0.46]
10-SY7000 -C10	2 position Single Double	1/4	C10 ø10 (One-touch fitting)	3.8	0.26	0.86	3.2	0.34	0.82	103	105	126	
										122	127	169	
	3 position Closed center Exhaust center Pressure center			2.8	0.27	0.67	2.4	0.21	0.59	130	135	177	143
				2.5	0.25	0.58	2.7	0.38	0.70	[2.4]	[0.31]	[0.61]	[0.56]
				3.8	0.25	0.89	2.3	0.38	0.61	[0.49]	[0.43]	[0.15]	

Note) []: denotes normal position.

10-SY5000

Valve model	Actuation type	Port size		Flow rate characteristics						Weight (g)			
		1, 5, 3 (P, EA, EB)	4, 2 (A, B)	1→4/2 (P→A/B) C (dm ³ /s(bar))	b	Cv	4/2→5/3 (AB→EA/EB) C (dm ³ /s(bar))	b	Cv	Gro- mmet	L/M plug connector	DIN terminal	W M8 connector
10-SY5000 -C01	2 position Single Double	1/8		1.9	0.35	0.49	2.4	0.39	0.61	70	72	93	
										88	93	135	
	3 position Closed center Exhaust center Pressure center			1.7	0.43	0.45	1.8	0.35	0.46	93	98	140	106
				1.5	0.44	0.41	2.5	0.32	0.59	[1.5]	[0.43]	[0.40]	
10-SY5000 -C4	2 position Single Double	1/8	C4 ø4 (One-touch fitting)	0.75	0.43	0.20	0.85	0.64	0.30	94	96	117	
										111	117	159	
	3 position Closed center Exhaust center Pressure center			0.74	0.40	0.19	0.84	0.57	0.28	117	122	164	130
				0.75	0.36	0.19	0.84	0.64	0.30	[0.84]	[0.53]	[0.27]	
10-SY5000 -C6	2 position Single Double	1/8	C6 ø6 (One-touch fitting)	0.78	0.44	0.21	0.84	0.57	0.27	88	91	112	
										106	111	153	
	3 position Closed center Exhaust center Pressure center			1.5	0.33	0.33	2.0	0.37	0.52	111	116	158	124
				1.3	0.31	0.33	1.8	0.35	0.44	[0.80]	[0.47]	[0.23]	
10-SY5000 -C8	2 position Single Double	1/8	C8 ø8 (One-touch fitting)	1.9	0.21	0.45	2.3	0.29	0.57	80	82	103	
										98	103	145	
	3 position Closed center Exhaust center Pressure center			1.6	0.29	0.39	1.7	0.38	0.46	103	108	150	116
				1.4	0.38	0.39	2.0	0.37	0.52	[1.5]	[0.41]	[0.43]	
				2.2	0.32	0.56	1.8	0.41	0.50	[1.6]	[0.44]	[0.44]	

Note) []: denotes normal position.

10-SY9000

Valve model	Actuation type	Port size		Flow rate characteristics						Weight (g)			
		1, 5, 3 (P, EA, EB)	4, 2 (A, B)	1→4/2 (P→A/B) C (dm ³ /s(bar))	b	Cv	4/2→5/3 (AB→EA/EB) C (dm ³ /s(bar))	b	Cv	Gro- mmet	L/M plug connector	DIN terminal	W M8 connector
10-SY9000 -C02	2 position Single Double	1/4		7.0	0.33	1.7	7.6	0.35	2.0	241	244	265	
										260	266	308	
	3 position Closed center Exhaust center Pressure center			6.7	0.37	1.7	6.4	0.34	1.6	284	290	332	298
				6.4	0.36	1.6	8.3	0.41	2.2	[4.1]	[0.27]	[2.2]	[0.91]
10-SY9000 -C03	2 position Single Double	3/8		8.0	0.29	1.9	8.0	0.33	2.0	236	239	260	
										255	261	303	
	3 position Closed center Exhaust center Pressure center			7.9	0.33	1.9	6.6	0.27	1.6	279	285	327	293
				8.0	0.33	1.9	8.7	0.34	2.2	[3.3]	[0.40]	[0.82]	[0.65]
10-SY9000 -C08	2 position Single Double	1/4	C8 ø8 (One-touch fitting)	4.3	0.28	0.96	7.1	0.32	1.7	293	296	317	
										312	318	360	
	3 position Closed center Exhaust center Pressure center			4.3	0.31	0.99	6.1	0.28	1.4	336	342	384	350
				4.3	0.3	0.98	7.4	0.36	1.9	[4.4]	[0.26]	[0.71]	[2.1]
10-SY9000 -C10	2 position Single Double	1/4	C10 ø10 (One-touch fitting)	6.1	0.28	1.4	7.9	0.33	1.9	279	282	303	
										298	304	346	
	3 position Closed center Exhaust center Pressure center			5.9	0.30	1.4	6.5	0.26	1.5	322	328	370	336
				5.8	0.25	1.3	8.4	0.33	2.0	[6.3]	[0.29]	[0.72]	[0.64]
10-SY9000 -C12	2 position Single Double	1/4	C12 ø12 (One-touch fitting)	7.0	0.25	1.6	8.6	0.41	2.2	265	268	289	
										284	290	332	
	3 position Closed center Exhaust center Pressure center			6.9	0.24	1.6	7.0	0.33	1.7	308	314	356	322
				6.6	0.23	1.4	9.4	0.48	2.6	[7.4]	[0.34]	[0.74]	[1.0]
				7.4	0.25	1.7	6.6	0.23	1.5	[3.2]	[0.34]	[0.74]	

Note) []: denotes normal position.

Dimensions: Series 10-SY3000

[] : AC

2 position single

Grommet (G), (H): 10-SY3120-□_G□□-C₄, N₃-(-F2)

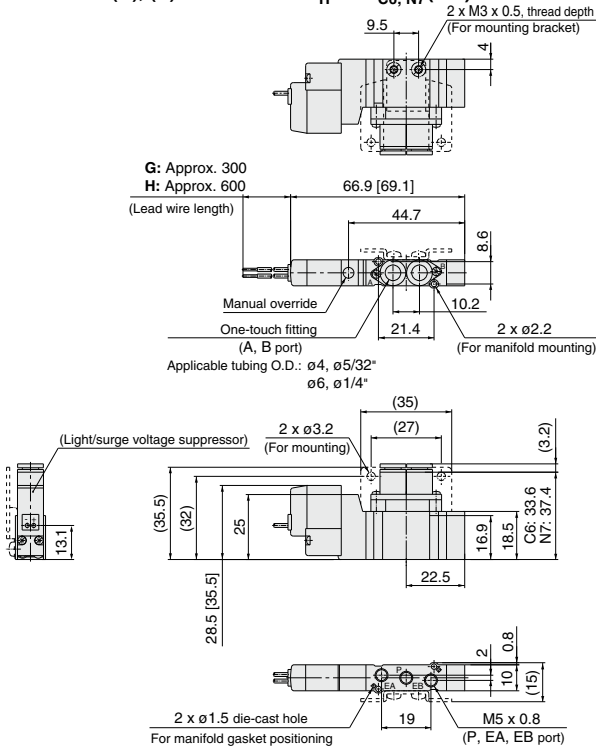

Foot bracket

10-SY3120-□_G□□-C₄, N₃-F1

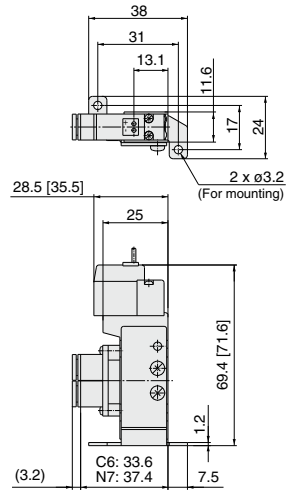

10-SY3120-□_G□□-M5(-F2)

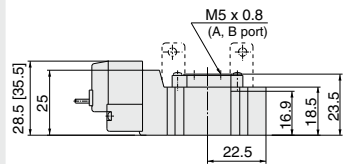

L plug connector (L):

10-SY3120-□L□□-C₄, N₃-(-F2)

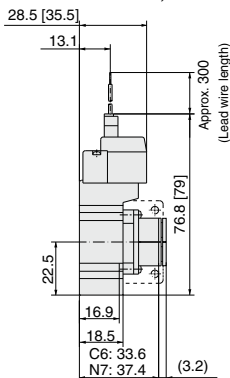

M plug connector (M):

10-SY3120-□M□□-C₄, N₃-(-F2)

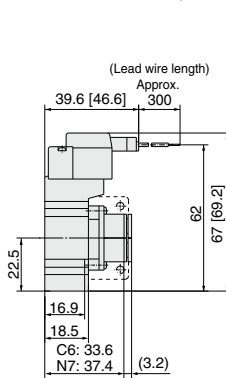

M8 connector (WO):

10-SY3120-□WO□□-C₄, N₃-(-F2)

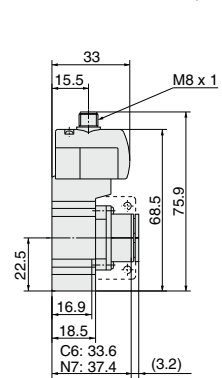

Note) Refer to page 176 for dimensions of connector types.

Directional Control Valves

Air Cylinders

Rotary Actuators

Air Grippers

Air Preparation Equipment

Modular F. R.

Pressure Control Equipment

Fittings & Tubing

Flow Control Equipment

Pressure Switches/ Pressure Sensors

Dimensions: Series 10-SY3000

[] : AC

2 position double

Grommet (G), (H): **10-SY3220-□G□□-C4, N3, C6, N7(-F2)**

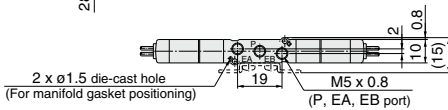
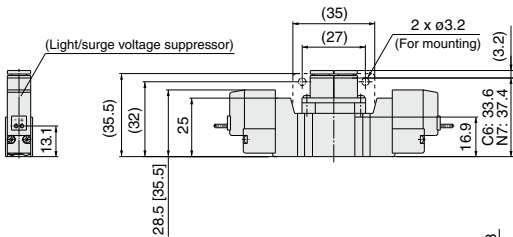
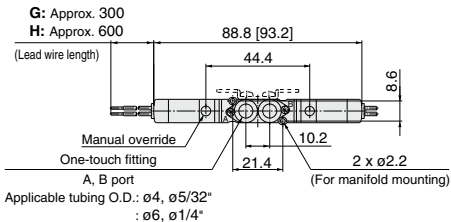
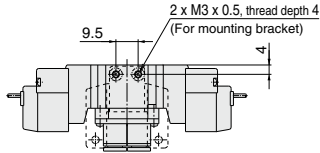

10-SY3220-□G□□-M5(-F2)

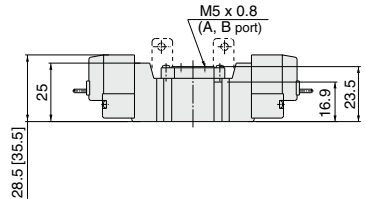

L plug connector (L):
10-SY3220-□L□□-C4, N3, C6, N7(-F2)

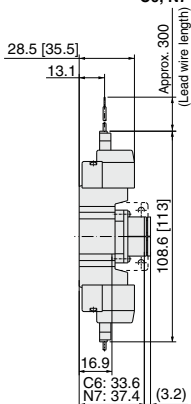

M plug connector (M):
10-SY3220-□M□□-C4, N3, C6, N7(-F2)

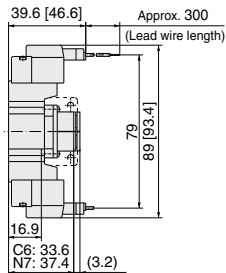

M8 connector (WO):
10-SY3220-WO□□-C4, N3, C6, N7(-F2)

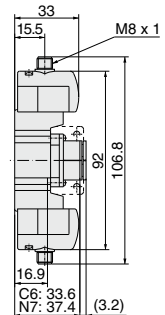

Note) Refer to page 176 for dimensions of connector types.

Dimensions: Series 10-SY3000

[]: AC

3 position closed center / exhaust center / pressure center
 Grommet (G), (H): 10-SY3^{3/8}20-□G□□-C4, N3 (-F2)
 C6, N7 (-F2)

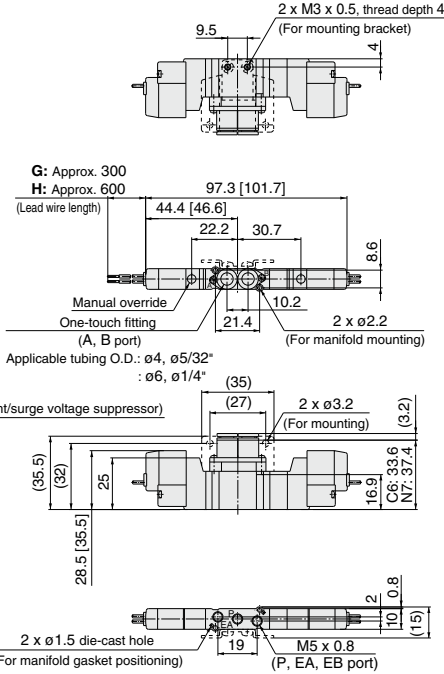

10-SY3^{3/8}20-□H□□-M5(-F2)

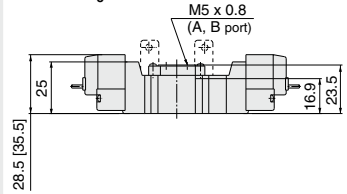

L plug connector (L):
 10-SY3^{3/8}20-□L□□-C4, N3 (-F2)
 C6, N7 (-F2)

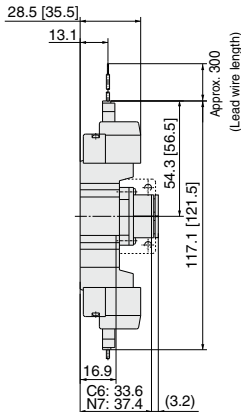

M plug connector (M):
 10-SY3^{3/8}20-□M□□-C4, N3 (-F2)
 C6, N7 (-F2)

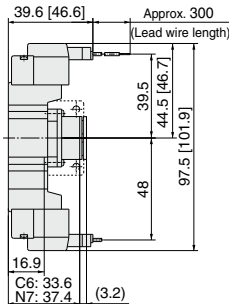

M8 connector (WO):
 10-SY3^{3/8}20-□WO□□-C4, N3 (-F2)
 C6, N7 (-F2)

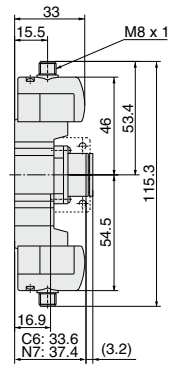

Note) Refer to page 176 for dimensions of connector types.

Directional Control Valves
 Air Cylinders
 Rotary Actuators
 Air Grippers
 Air Preparation Equipment
 Modular F. R.
 Pressure Control Equipment
 Fittings & Tubing
 Flow Control Equipment
 Pressure Switches/ Pressure Sensors

Dimensions: Series 10-SY5000

[] : AC

2 position single

Grommet (G), (H): 10-SY5120-□□□□^{C4, N3}_{C6, N7}-□□(-F2)
□□□□^{C4, N3}_{C8, N9}

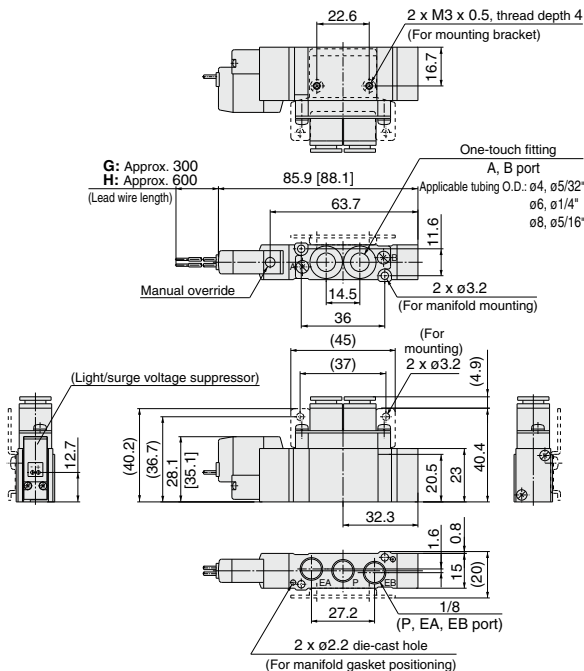

Foot bracket

10-SY5120-□□□□^{C4, N3}_{C6, N7}-□□(-F1)
□□□□^{C4, N3}_{C8, N9}

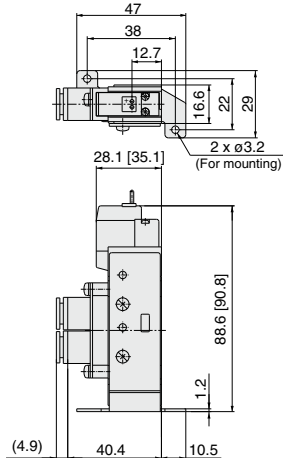

10-SY5120-□□□□^G_H-□□□□-01□□(-F2)

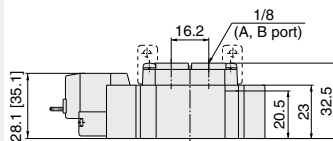

L plug connector (L):

10-SY5120-□□□□^{C4, N3}_{C6, N7}-□□(-F2)
□□□□^{C4, N3}_{C8, N9}

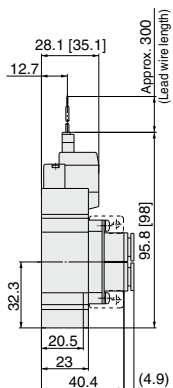

M plug connector (M):

10-SY5120-□□□□^{C4, N3}_{C6, N7}-□□(-F2)
□□□□^{C4, N3}_{C8, N9}

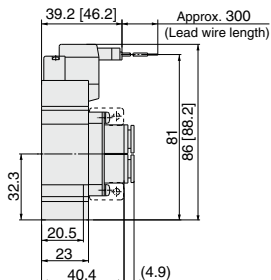

DIN terminal (D, Y):

10-SY5120-□□□□^{C4, N3}_{C6, N7}-□□(-F2)
□□□□^{C4, N3}_{C8, N9}

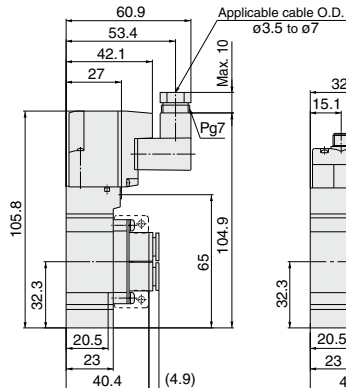

M8 connector (WO):

10-SY5120-□□WO□□^{C4, N3}_{C6, N7}-□□(-F2)
□□□□^{C4, N3}_{C8, N9}

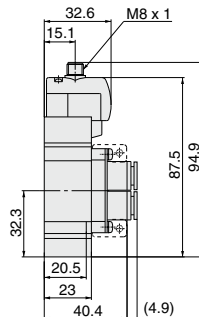

Note) Refer to page 176 for dimensions of connector types.

Dimensions: Series 10-SY5000

[]: AC

2 position double

Grommet (G), (H): 10-SY5220-□G□□□□C4, N3
C6, N7□□(-F2)
C8, N9

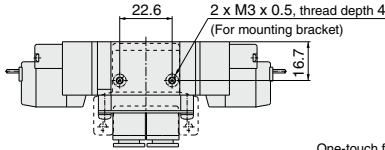

10-SY5220-□G□□□□01□□(-F2)

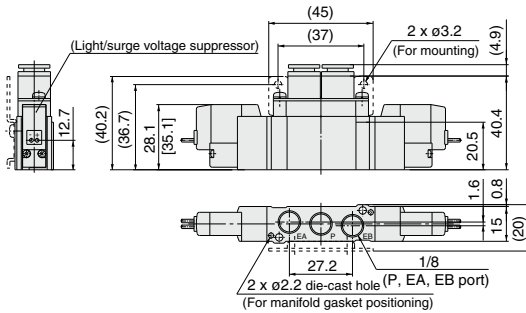
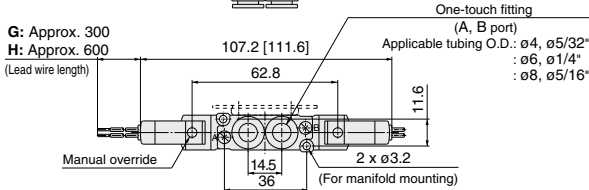
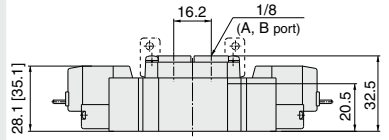

L plug connector (L):

10-SY5220-□L□□□□C4, N3
C6, N7□□(-F2)
C8, N9

M plug connector (M):

10-SY5220-□M□□□□C4, N3
C6, N7□□(-F2)
C8, N9

DIN terminal (D, Y):

10-SY5220-□D□□□□C4, N3
C6, N7□□(-F2)
C8, N9

M8 connector (WO):

10-SY5220-□WO□□□□C4, N3
C6, N7□□(-F2)
C8, N9

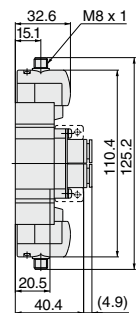
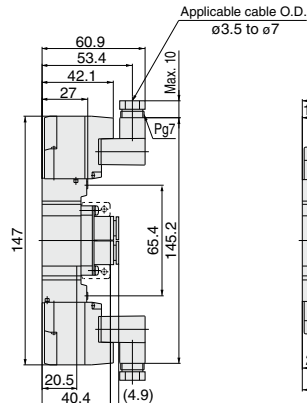
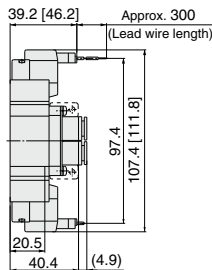
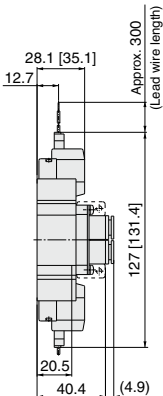

Note) Refer to page 176 for dimensions of connector types.

Directional Control Valves
Air Cylinders
Rotary Actuators
Air Grippers
Air Preparation Equipment
Modular F. R.
Pressure Control Equipment
Fittings & Tubing
Flow Control Equipment
Pressure Switches/Pressure Sensors

Dimensions: Series 10-SY5000

[] : AC

3 position closed center / exhaust center / pressure center
Grommet (G), (H): 10-SY5³₅420-□□□□-³₅C4, N3, C6, N7, C8, N9 □□(-F2)

10-SY5³₅420-□□□□-01□□(-F2)

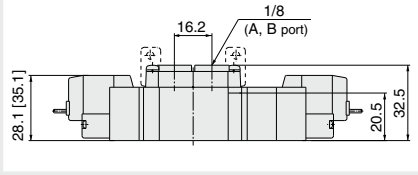
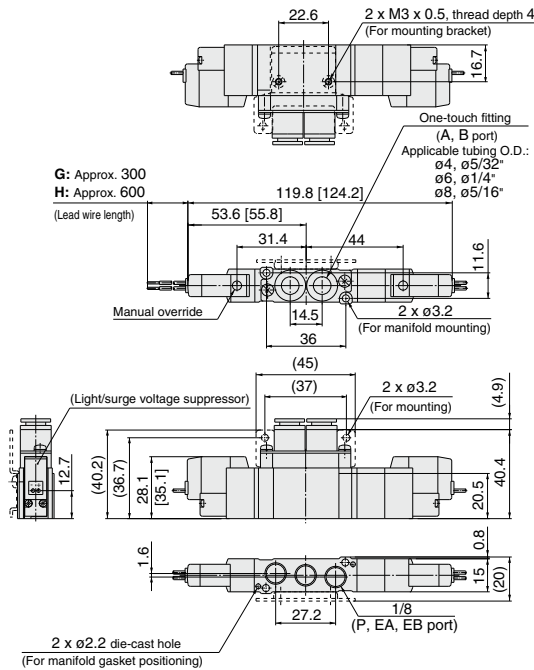

L plug connector (L):
10-SY5³₅420-□□□□-³₅C4, N3, C6, N7, C8, N9 □□(-F2)

M plug connector (M):
10-SY5³₅420-□□□□-³₅C4, N3, C6, N7, C8, N9 □□(-F2)

DIN terminal (D, Y):
10-SY5³₅420-□□□□-³₅C4, N3, C6, N7, C8, N9 □□(-F2)

M8 connector (WO):
10-SY5³₅420-□□□□-³₅C4, N3, C6, N7, C8, N9 □□(-F2)

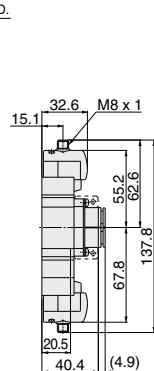
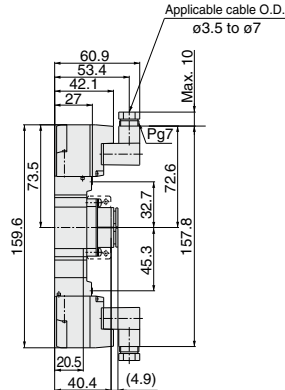
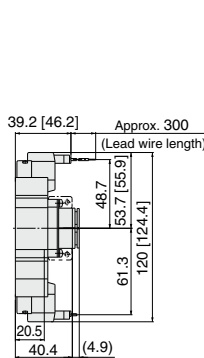
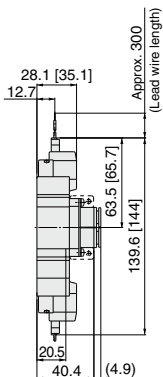

Note) Refer to page 176 for dimensions of connector types.

Dimensions: Series 10-SY7000

[] : AC

2 position single

Grommet (G), (H): 10-SY7120-□G□□-C8, N9 C10, N11 □(-F2)

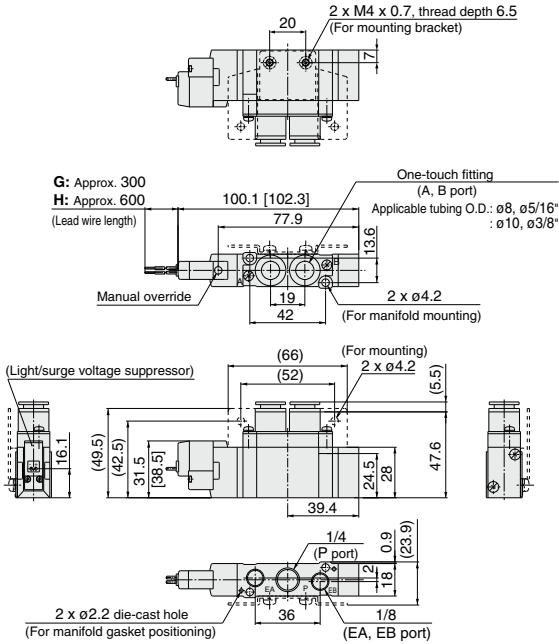

10-SY7120-□G□□-C8, N9 C10, N11 □(-F1)

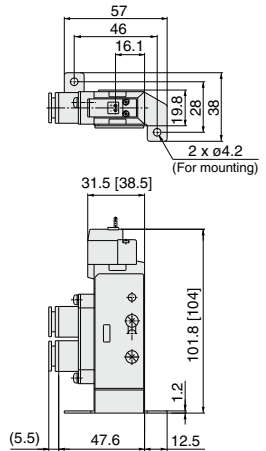

10-SY7120-□G□□-02□(-F2)

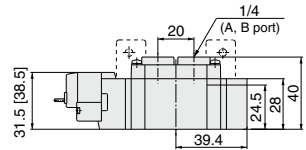

L plug connector (L):

10-SY7120-□L□□-C8, N9 C10, N11 □(-F2)

M plug connector (M):

10-SY7120-□M□□-C8, N9 C10, N11 □(-F2)

DIN terminal (D, Y):

10-SY7120-□D□□-C8, N9 C10, N11 □(-F2)

M8 connector (WO):

10-SY7120-□WO□□-C8, N9 C10, N11 □(-F2)

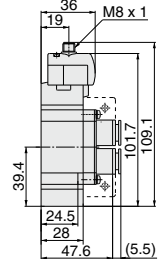
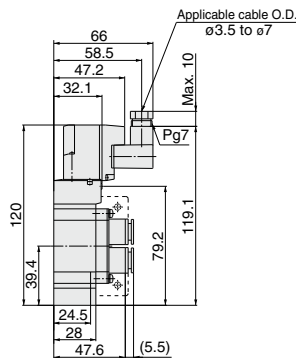
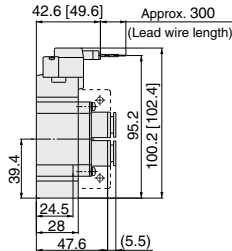
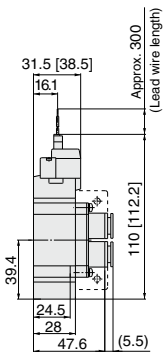

(Note) Refer to page 176 for dimensions of connector types.

Dimensions: Series 10-SY7000

[]: AC

2 position double

Grommet (G), (H): 10-SY7220-□G□□-C8, N9 C10, N11 □(-F2)

10-SY7220-□GH□□-02□(-F2)

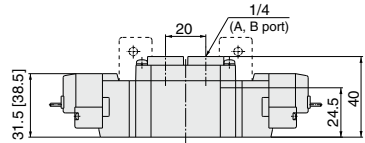
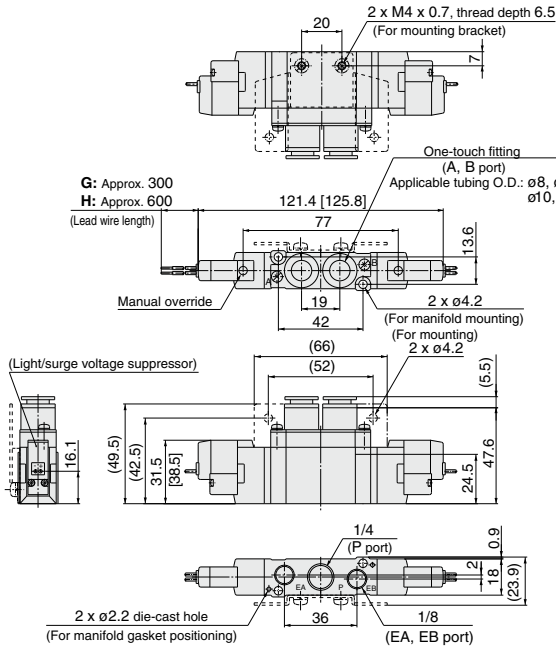

L plug connector (L):
10-SY7220-□L□□-C8, N9 C10, N11 □(-F2)

M plug connector (M):
10-SY7220-□M□□-C8, N9 C10, N11 □(-F2)

DIN terminal (D, Y):
10-SY7220-□DY□□-C8, N9 C10, N11 □(-F2)

M8 connector (WO):
10-SY7220-□WO□□-C8, N9 C10, N11 □(-F2)

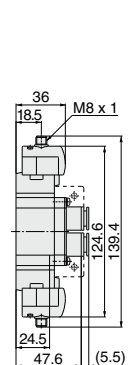
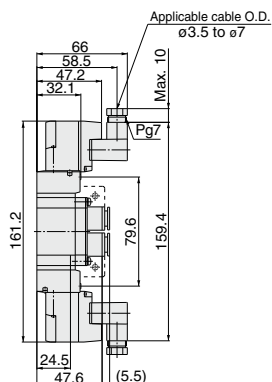
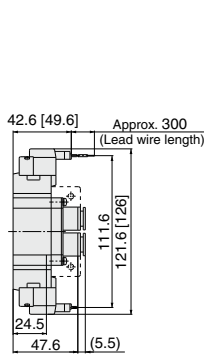
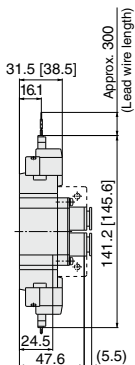

Note) Refer to page 176 for dimensions of connector types.

Dimensions: Series 10-SY7000

[] : AC

3 position closed center / exhaust center / pressure center
Grommet (G), (H): 10-SY7³/₅20-□G□□-C8, N9
C10, N11□(-F2)

10-SY7³/₅20-□H□□-02□(-F2)

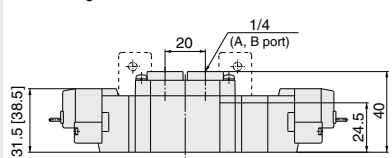
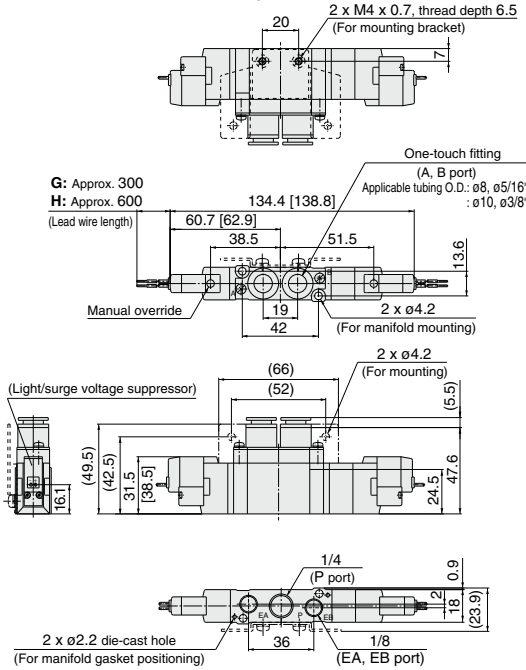

L plug connector (L):

M plug connector (M):

DIN terminal (D, Y):

M8 connector (WO):

10-SY7³/₅20-□L□□-C8, N9
C10, N11□(-F2)

10-SY7³/₅20-□M□□-C8, N9
C10, N11□(-F2)

10-SY7³/₅20-□D□□-C8, N9
C10, N11□(-F2)

10-SY7³/₅20-□WO□□-C8, N9
C10, N11□(-F2)

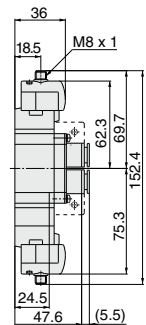
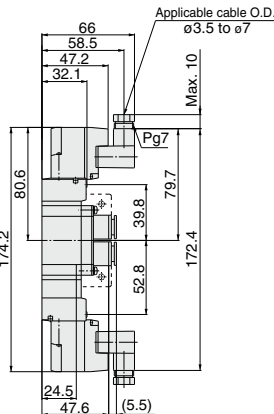
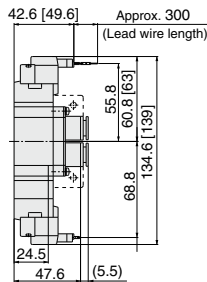
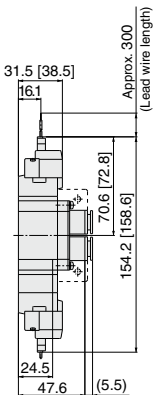

Note) Refer to page 176 for dimensions of connector types.

Directional Control Valves

Air Cylinders

Rotary Actuators

Air Grippers

Air Preparation Equipment

Modular F. R.

Pressure Control Equipment

Fittings & Tubing

Flow Control Equipment

Pressure Switches/ Pressure Sensors

Dimensions: Series 10-SY9000

[] : AC

2 position single

**Grommet (G), (H): 10-SY9120-□^G□□□□ C8, N9
C10, N11□ C12**

10-SY9120-□^G□□□□-02□⁰³

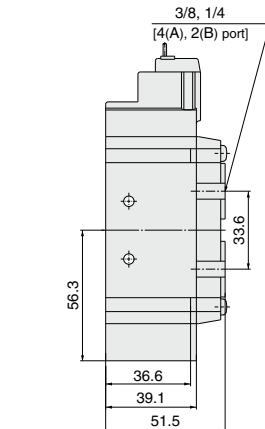
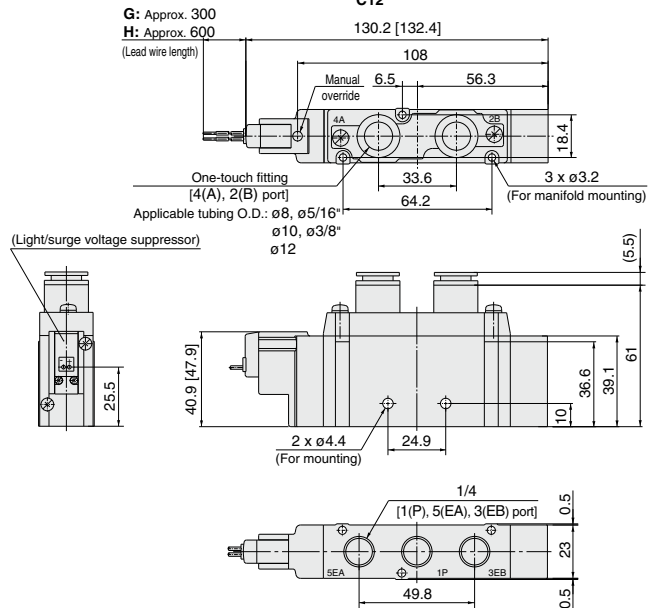

L plug connector (L):
**10-SY9120-□^L□□□□ C8, N9
C10, N11□ C12**

M plug connector (M):
**10-SY9120-□^M□□□□ C8, N9
C10, N11□ C12**

DIN terminal (D, Y):
**10-SY9120-□^D□□□□ C8, N9
C10, N11□ C12**

M8 connector (WO):
**10-SY9120-□^{WO}□□□□ C8, N9
C10, N11□ C12**

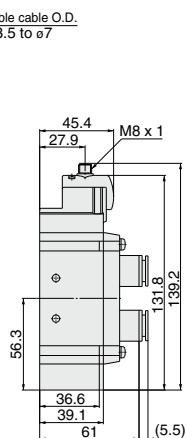
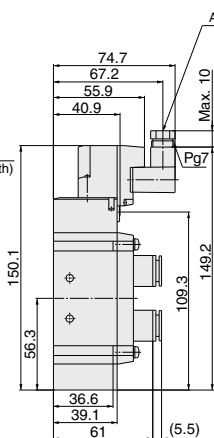
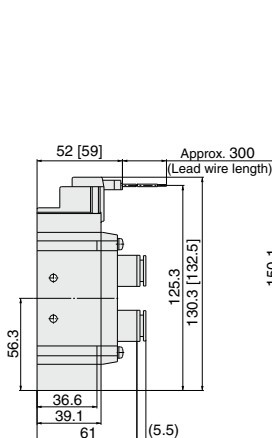
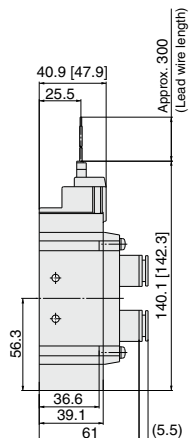

Note) Refer to page 176 for dimensions of connector types.

Dimensions: Series 10-SY9000

[] : AC

2 position double

Grommet (G), (H): 10-SY9220-□^G□^H□^{C8, N9}□^{C10, N11}□^{C12}

G: Approx. 300
H: Approx. 600

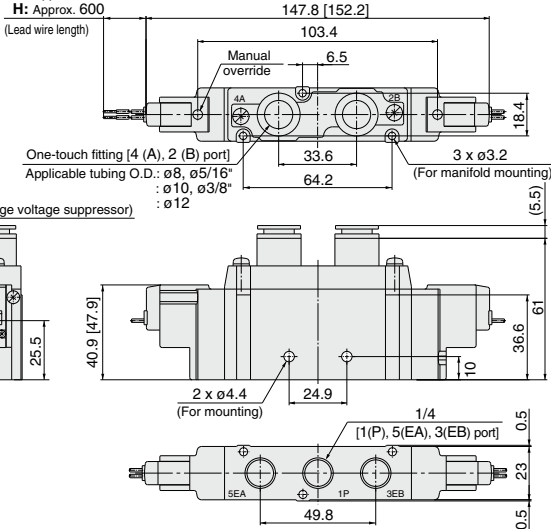

10-SY9220-□^G□^H□^{C8, N9}□^{C10, N11}□^{C12}

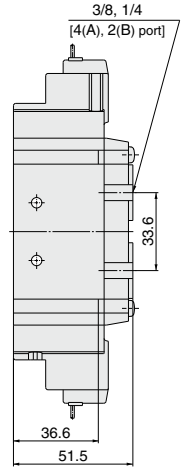

L plug connector (L):

10-SY9220-□^L□^{C8, N9}□^{C10, N11}□^{C12}

M plug connector (M):

10-SY9220-□^M□^{C8, N9}□^{C10, N11}□^{C12}

DIN terminal (D, Y):

10-SY9220-□^D□^Y□^{C8, N9}□^{C10, N11}□^{C12}

M8 connector (WO):

10-SY9220-□^{WO}□^{C8, N9}□^{C10, N11}□^{C12}

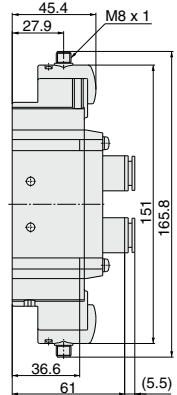
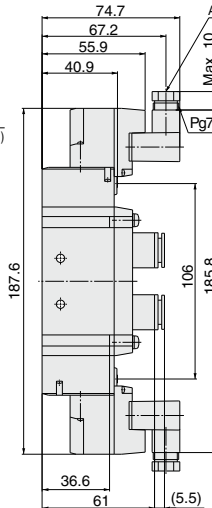
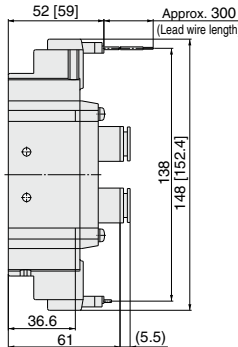
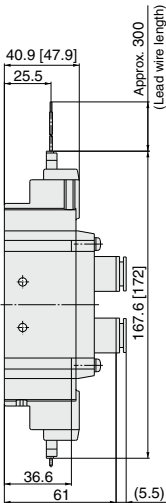

Note) Refer to page 176 for dimensions of connector types.

Dimensions: Series 10-SY9000

[]: AC

3 position closed center / exhaust center / pressure center

Grommet (G), (H): 10-SY9³/₅20-□^G□□-^{C8, N9}□□-^{C10, N11}□□

G: Approx. 300
H: Approx. 600
(Lead wire length)

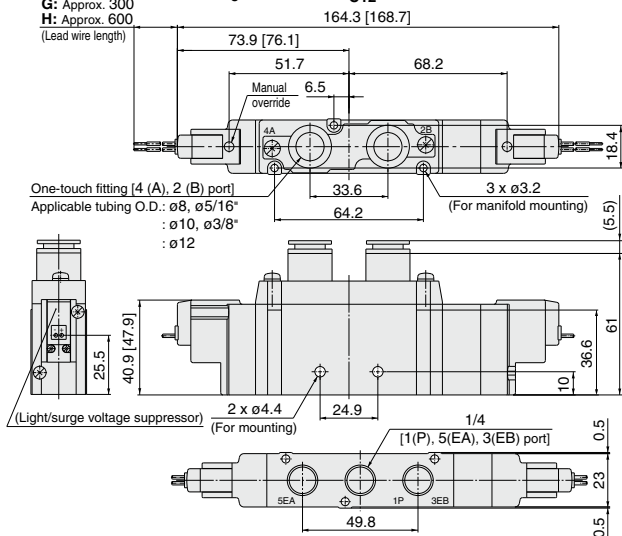

10-SY9³/₅20-□^G□□-^{C8, N9}□□-^{C10, N11}□□

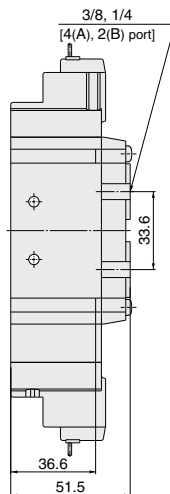

L plug connector (L):

10-SY9³/₅20-□□□□-^{C8, N9}□□□□-^{C10, N11}□□□□-^{C12}□□□□

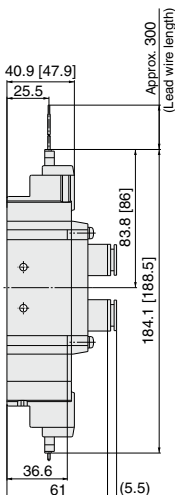

M plug connector (M):

10-SY9³/₅20-□□□□□□-^{C8, N9}□□□□□□-^{C10, N11}□□□□□□-^{C12}□□□□□□

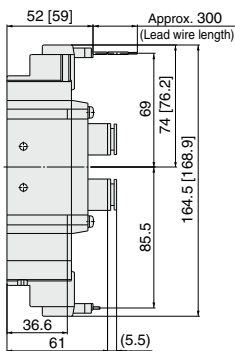

DIN terminal (D, Y):

10-SY9³/₅20-□□□□□□□□-^{C8, N9}□□□□□□□□-^{C10, N11}□□□□□□□□-^{C12}□□□□□□□□

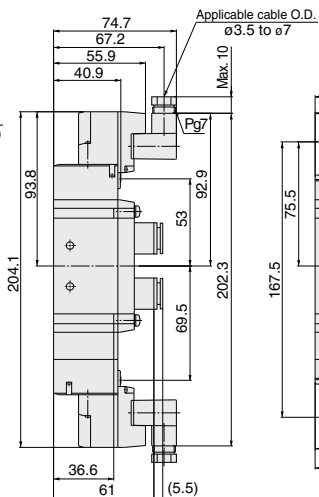

M8 connector (WO):

10-SY9³/₅20-□□□□□□□□□□-^{C8, N9}□□□□□□□□□□-^{C10, N11}□□□□□□□□□□-^{C12}□□□□□□□□□□

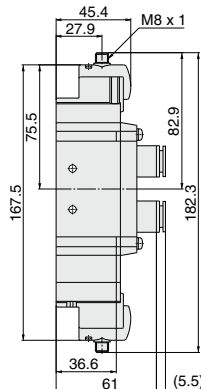

Note) Refer to page 176 for dimensions of connector types.

Series 10-SY3000/5000/7000/9000

5 Port Solenoid Valve
Base Mounted/Single Unit



[Option]
Note) AC-type models that are CE-compliant have DIN terminals only.

How to Order

10 - SY 5 2 40 [] - 5 L [] - [] - [] - []

• Clean series
Series

3	10-SY3000
5	10-SY5000
7	10-SY7000
9	10-SY9000

• Actuation type

1	2 position single (A)4 2(B) (EA)5 1 3(EB) (P)
2	2 position double (A)4 2(B) (EA)5 1 3(EB) (P)
3	3 position closed center (A)4 2(B) (EA)5 1 3(EB) (P)
4	3 position exhaust center (A)4 2(B) (EA)5 1 3(EB) (P)
5	3 position pressure center (A)4 2(B) (EA)5 1 3(EB) (P)

Note) For details about Symbol of the 3 position type 10-SY9000 series, refer to the SY series of the WEB catalog.

• Pilot type

Nil	Internal pilot
R	External pilot*

* External pilot specifications for 10-SY3000 DIN terminal are not available.

• Coil type

Nil	Standard
T	With power saving circuit (24, 12 VDC only)

* Power saving circuit is not available for D, Y, DO, YO or W□ types.

• Rated voltage

For DC	
5	24 VDC
6	12 VDC
V	6 VDC
S	5 VDC
R	3 VDC

• For AC (50/60 Hz)

1	100 VAC
2	200 VAC
3	110 VAC [115 VAC]
4	220 VAC [230 VAC]

* DC specifications of type D, Y, DO and YO are only available with 12 and 24 VDC.
* For type W□, only DC voltage is available.

• Port size

Symbol	Port size	Applicable series
Nil	Without sub-plate	
01	1/8 With sub-plate	10-SY3000
02	1/4 With sub-plate	10-SY5000 10-SY7000
03	3/8 With sub-plate	10-SY7000 10-SY9000
04	1/2 With sub-plate	10-SY9000

• Thread type

Nil	Rc
F	G
N	NPT
T	NPTF

• Made to Order

Nil	—
X90	Main valve fluororubber (Refer to page 169.)

• Manual override

Nil: Non-locking push type

D: Push-turn locking slotted type

E: Push-turn locking lever type

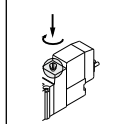
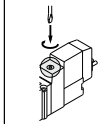
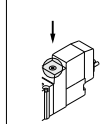

• CE-compliant

Nil	—
Q	CE-compliant

Note)
AC-type models that are CE-compliant have DIN terminals only.

• Light/Surge voltage suppressor

Electrical entry for G, H, L, M, W

Nil	Without light/surge voltage suppressor
S	With surge voltage suppressor
Z	With light/surge voltage suppressor
R	With surge voltage suppressor (Non-polar type)
U	With light/surge voltage suppressor (Non-polar type)

* For AC voltage valves there is no "S" option. It is already built into the rectifier circuit.
* For "R" and "U", only DC voltage is available.
* Power saving circuit is only available for the "Z" type.

Electrical entry for D, Y

Nil	Without light/surge voltage suppressor
S	With surge voltage suppressor (Non-polar type)
Z	With light/surge voltage suppressor (Non-polar type)

* DOZ and YOZ are not available.
* For AC voltage valves there is no "S" option. It is already built into the rectifier circuit.

• Electrical entry

24, 12, 6, 5, 3 VDC / 100, 110, 200, 220 VAC				24, 12 VDC / 100, 110, 200, 220 VAC	24, 12, 6, 5, 3 VDC
Grommet	L plug connector	M plug connector	DIN terminal	D, Y: With connector	M8 connector
G: Lead wire length 300 mm 	L: With lead wire (Length 300 mm) 	M: With lead wire (Length 300 mm) 	MN: Without lead wire 	WO: Without connector cable 	W□: With connector cable (Note)
H: Lead wire length 600 mm 	LN: Without lead wire 	LO: Without connector 	MO: Without connector 	DO, YO: Without connector 	W□: With connector cable (Note)
CE-compliant	DC	—	—	—	—

* LN, MN type: With 2 sockets.

* The DIN terminal of the 10-SY3000 series cannot be mounted on the standard sub-plate. For details, refer to page 174.

* "Y" type is a DIN terminal conforming to EN-175301-803C (former DIN43650C). For details, refer to page 173.

* For connector cable of M8 connector, refer to page 176.

* M8 connector conforming to IEC60947-5-2 standard is also available. Refer to page 168 for details.

* Refer to page 173 for the lead wire length of L and M plug connectors.

* Refer to page 174 for the connector assembly with cover for L and M plug connectors.

Note) Enter the cable length symbols in □. Please be sure to fill in the blank referring to page 176.

Note) When ordering a single unit of the base mounted type solenoid valve, the mounting screws and gasket for the manifold are included.

Directional Control Valves

Air Cylinders

Rotary Actuators

Air Grippers

Air Preparation Equipment

Modular F. R.

Pressure Control Equipment

Fittings & Tubing

Flow Control Equipment

Pressure Switches/Pressure Sensors

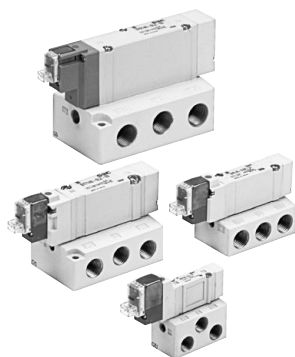

Made to Order
(For details, refer to pages 166 to 169.)

Specifications

Series	10-SY3000	10-SY5000	10-SY7000	10-SY9000		
Fluid	Air					
Internal pilot operating pressure range (MPa)	2 position single		0.15 to 0.7			
	2 position double		0.1 to 0.7			
	3 position		0.2 to 0.7			
External pilot operating pressure range (MPa)	Operating pressure range					
	Pilot pressure		-100 kPa to 0.7			
	2 position single		0.25 to 0.7			
	2 position double		0.25 to 0.7			
3 position		0.25 to 0.7				
Ambient and fluid temperature (°C)						
-10 to 50 (No freezing.)						
Max. operating frequency (Hz)	2 position single, double		10	5	5	5
	3 position		3	3	3	3
Manual override (Manual operation)		Non-locking push type, Push-turn locking slotted type, Push-turn locking lever type				
Pilot exhaust method	Internal pilot		Main/Pilot valve common exhaust			
	External pilot		Pilot valve individual exhaust			
Lubrication		Not required				
Mounting orientation		Unrestricted				
Impact/Vibration resistance (m/s ²) ^{Note)}		150/30				
Enclosure		Dust proof (* DIN terminal and M8 connector: IP65)				

* Based on IEC60529

Note) Impact resistance: No malfunction occurred when it was tested in the axial direction and at right angles to the main valve and armature in both energized and de-energized states once for each condition. (Default settings)

Vibration resistance: No malfunction occurred in a one-sweep test between 45 and 2000 Hz. Test was performed in both energized and de-energized states in the axial direction and at right angles to the main valve and armature. (Default settings)

Response Time

Note) Based on dynamic performance test, JIS B 8375-1981. (Coil temperature: 20°C, at rated voltage)

10-SY3000

Actuation type	Response time (ms) (at the pressure of 0.5 MPa)			
	Without light/surge voltage suppressor		With light/surge voltage suppressor	
	Type S, Z	Type R, U	Type S, Z	Type R, U
2 position single	12 or less	15 or less	12 or less	15 or less
2 position double	10 or less	13 or less	10 or less	13 or less
3 position	15 or less	20 or less	16 or less	20 or less

10-SY5000

Actuation type	Response time (ms) (at the pressure of 0.5 MPa)			
	Without light/surge voltage suppressor		With light/surge voltage suppressor	
	Type S, Z	Type R, U	Type S, Z	Type R, U
2 position single	19 or less	26 or less	19 or less	26 or less
2 position double	18 or less	22 or less	18 or less	22 or less
3 position	32 or less	38 or less	32 or less	38 or less

10-SY7000

Actuation type	Response time (ms) (at the pressure of 0.5 MPa)			
	Without light/surge voltage suppressor		With light/surge voltage suppressor	
	Type S, Z	Type R, U	Type S, Z	Type R, U
2 position single	31 or less	38 or less	33 or less	41 or less
2 position double	27 or less	30 or less	28 or less	33 or less
3 position	50 or less	56 or less	50 or less	56 or less

10-SY9000

Actuation type	Response time (ms) (at the pressure of 0.5 MPa)			
	Without light/surge voltage suppressor		With light/surge voltage suppressor	
	Type S, Z	Type R, U	Type S, Z	Type R, U
2 position single	35 or less	41 or less	35 or less	41 or less
2 position double	35 or less	41 or less	35 or less	41 or less
3 position	62 or less	64 or less	62 or less	64 or less

Solenoid Specifications

Electrical entry		Grommet (G), (H)		DIN terminal (D), (Y)	
		L plug connector (L)		M8 connector (W)	
		M plug connector (M)			
		G, H, L, M, W		D, Y	
Coil rated voltage (V)	DC	24, 12, 6, 5, 3			
	AC 50/60 Hz	100, 110, 200, 220			
Allowable voltage fluctuation		±10% of rated voltage *			
Power consumption (W)	Standard	0.35 (With indicator light: 0.4, DIN terminal with indicator light: 0.45)			
	DC With power saving circuit	0.1 (With indicator light only) * [Starting 0.4, Holding 0.1]			
Apparent power (VA) *	AC	100 V	0.78 (With indicator light: 0.81)	0.78 (With indicator light: 0.87)	
		110 V [115 V]	0.86 (With indicator light: 0.89)	0.86 (With indicator light: 0.97)	
		200 V	1.18 (With indicator light: 1.22)	1.15 (With indicator light: 1.30)	
		220 V [230 V]	1.30 (With indicator light: 1.34)	1.27 (With indicator light: 1.46)	
Surge voltage suppressor		Diode (Varistor is for DIN terminal and non-polar type.)			
Indicator light		LED (AC of DIN connector is neon light.)			

* Common between 110 VAC and 115 VAC, and between 220 VAC and 230 VAC.

* For 115 VAC and 230 VAC, the allowable voltage is -15% to +5% of rated voltage.

* DIN terminal and M8 connector with power saving circuit are not available.

* For details, refer to page 171.

Flow Rate Characteristics/Weight

10-SY3000

Valve model	Actuation type		Port size	Flow rate characteristics <small>Note 1)</small>						Weight (g) <small>Note 2)</small>		
				1 → 4/2 (P → A/B)			4/2 → 5/3 (A/B → EA/EB)			Grommet	L plug connector, M plug connector	W M8 connector
				C (dm ³ /s/bar)	b	Cv	C (dm ³ /s/bar)	b	Cv			
10-SY3□40-□-01	2 position	Single	1/6	1.0	0.30	0.24	1.1	0.30	0.26	84 (50)	85 (53)	89 (57)
		Double		0.77	0.28	0.18	0.85	0.30	0.19	102 (68)	107 (73)	115 (81)
	Closed center	0.73		0.31	0.18	1.1	0.26	0.24	104 (69)	109 (74)	117 (82)	
	Exhaust center	1.2		0.24	0.29	[0.55]	[0.52]	[0.16]				
	Pressure center	[0.51]		[0.45]	[0.14]	0.89	0.47	0.24				

Note 1) []: denotes normal position. Note 2) (): denotes without sub-plate.

10-SY5000

Valve model	Actuation type		Port size	Flow rate characteristics <small>Note 1)</small>						Weight (g) <small>Note 2)</small>			
				1 → 4/2 (P → A/B)			4/2 → 5/3 (A/B → EA/EB)			Grommet	L plug connector, M plug connector	DIN terminal	W M8 connector
				C (dm ³ /s/bar)	b	Cv	C (dm ³ /s/bar)	b	Cv				
10-SY5□40-□-02	2 position	Single	1/4	2.4	0.41	0.64	2.8	0.29	0.66	121 (58)	123 (61)	154 (92)	127 (65)
		Double		1.8	0.47	0.50	1.8	0.40	0.47	139 (76)	144 (81)	186 (123)	152 (89)
	Closed center	1.4		0.55	0.44	3.0	0.33	0.72	144 (82)	150 (87)	192 (129)	158 (95)	
	Exhaust center	[1.2]		[0.84]	[0.37]	[1.2]	[0.48]	[0.37]					
	Pressure center	3.3		0.36	0.85	1.8	0.40	0.48					

Note 1) []: denotes normal position. Note 2) (): denotes without sub-plate.

10-SY7000

Valve model	Actuation type		Port size	Flow rate characteristics <small>Note 1)</small>						Weight (g) <small>Note 2)</small>			
				1 → 4/2 (P → A/B)			4/2 → 5/3 (A/B → EA/EB)			Grommet	L plug connector, M plug connector	DIN terminal	W M8 connector
				C (dm ³ /s/bar)	b	Cv	C (dm ³ /s/bar)	b	Cv				
10-SY7□40-□-02	2 position	Single	1/4	4.1	0.41	1.1	4.1	0.29	1.0	218 (89)	221 (92)	242 (113)	225 (96)
		Double		3.0	0.43	0.80	2.6	0.41	0.72	237 (108)	242 (113)	284 (155)	250 (121)
	Closed center	2.6		0.42	0.71	4.7	0.35	1.1	239 (110)	245 (116)	287 (158)	253 (124)	
	Exhaust center	5.3		0.39	1.3	[1.7]	[0.48]	[0.49]					
	Pressure center	[2.3]		[0.49]	[0.65]	2.2	0.49	0.63					
10-SY7□40-□-03	2 position	Single	3/8	4.9	0.29	1.2	4.5	0.27	1.1	218 (89)	221 (92)	242 (113)	225 (96)
		Double		3.0	0.40	0.80	2.6	0.45	0.73	237 (108)	242 (113)	284 (155)	250 (121)
	Closed center	2.6		0.42	0.71	4.8	0.35	1.1	239 (110)	245 (116)	287 (158)	253 (124)	
	Exhaust center	5.3		0.31	1.3	[1.7]	[0.48]	[0.49]					
	Pressure center	[2.3]		[0.51]	[0.64]	2.3	0.45	0.66					

Note 1) []: denotes normal position. Note 2) (): denotes without sub-plate.

10-SY9000

Valve model	Actuation type		Port size	Flow rate characteristics <small>Note 1)</small>						Weight (g) <small>Note 2)</small>			
				1 → 4/2 (P → A/B)			4/2 → 5/3 (A/B → EA/EB)			Grommet	L plug connector, M plug connector	DIN terminal	W M8 connector
				C (dm ³ /s/bar)	b	Cv	C (dm ³ /s/bar)	b	Cv				
10-SY9□40-□-03	2 position	Single	3/8	7.9	0.34	2.0	9.6	0.43	2.6	469 (172)	472 (175)	493 (196)	476 (179)
		Double		7.5	0.33	1.8	7.3	0.30	1.7	488 (191)	494 (197)	535 (239)	502 (205)
	Closed center	7.2		0.34	1.7	13	0.23	2.8	512 (215)	518 (221)	560 (263)	526 (229)	
	Exhaust center	[4.0]		[0.41]	[0.95]	[4.0]	[0.41]	[0.95]					
	Pressure center	12		0.26	2.8	6.7	0.40	1.9					
10-SY9□40-□-04	2 position	Single	1/2	8.0	0.48	2.2	10	0.29	2.5	448 (172)	453 (175)	472	457 (179)
		Double		7.6	0.32	1.8	7.3	0.32	1.8	467 (191)	473 (197)	515	481 (205)
	Closed center	7.3		0.42	2.0	13	0.32	3.6	491 (215)	497 (221)	539	505 (229)	
	Exhaust center	[4.7]		[0.54]	[1.5]	[4.7]	[0.54]	[1.5]					
	Pressure center	12		0.33	3.3	7.4	0.33	1.9					

Note 1) []: denotes normal position. Note 2) (): denotes without sub-plate.

Dimensions: Series 10-SY3000

[] : AC

2 position single

Grommet (G), (H): 10-SY3140(R)-□^G□□-01□

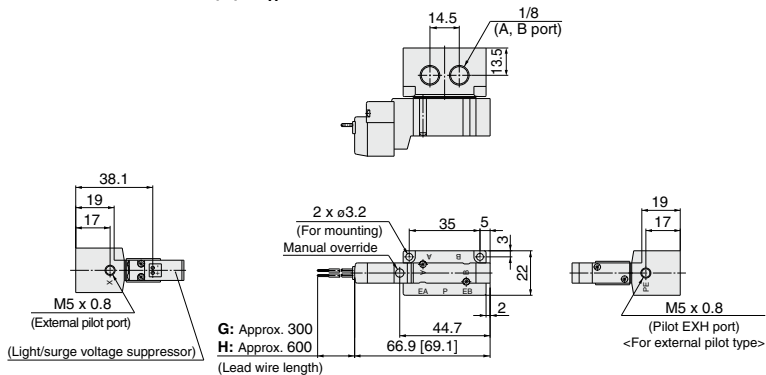

L plug connector (L):
 10-SY3140(R)-□L□□-01□

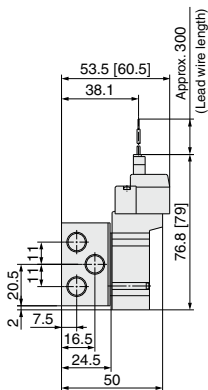

M plug connector (M):
 10-SY3140(R)-□M□□-01□

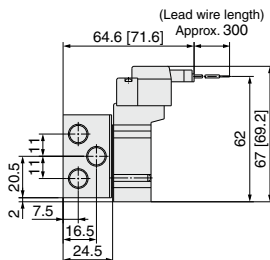

M8 connector (WO):
 10-SY3140(R)-□WO□□-01□

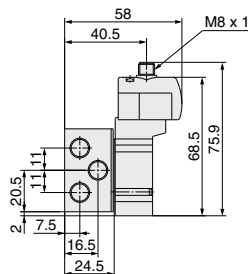

Note) Refer to page 176 for dimensions of connector types.

Dimensions: Series 10-SY3000

[] : AC

2 position double

Grommet (G), (H): 10-SY3240(R)-□^G□□-01□

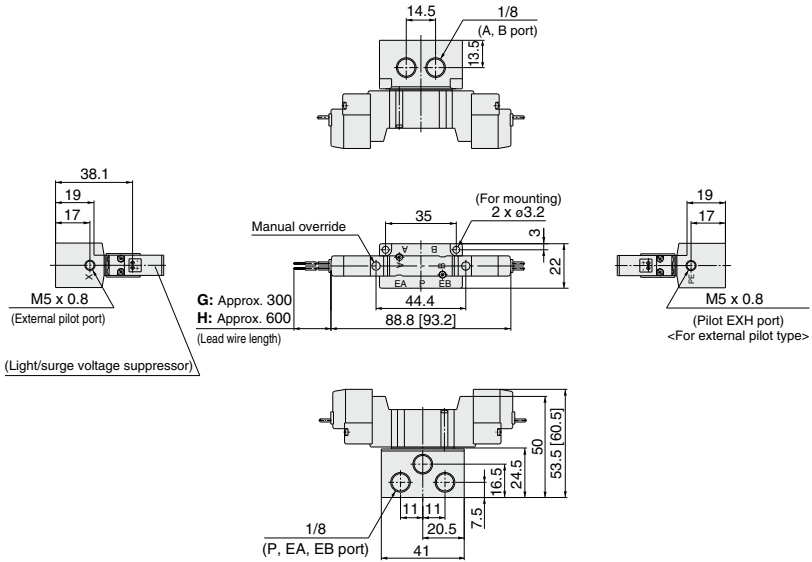

L plug connector (L):
10-SY3240(R)-□L□□-01□

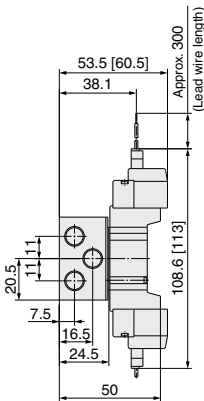

M plug connector (M):
10-SY3240(R)-□M□□-01□

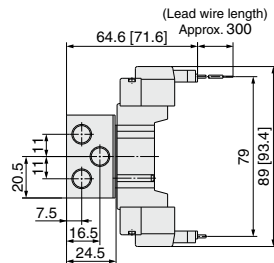

M8 connector (WO):
10-SY3240(R)-□WO□□-01□

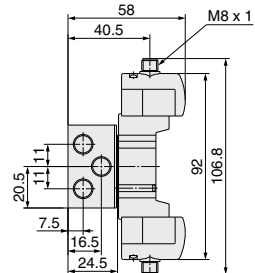

Note) Refer to page 176 for dimensions of connector types.

Dimensions: Series 10-SY3000

[]: AC

3 position closed center / exhaust center / pressure center

Grommet (G), (H): 10-SY3 $\frac{3}{4}$ 40(R)-□ $\frac{G}{H}$ □□-01□

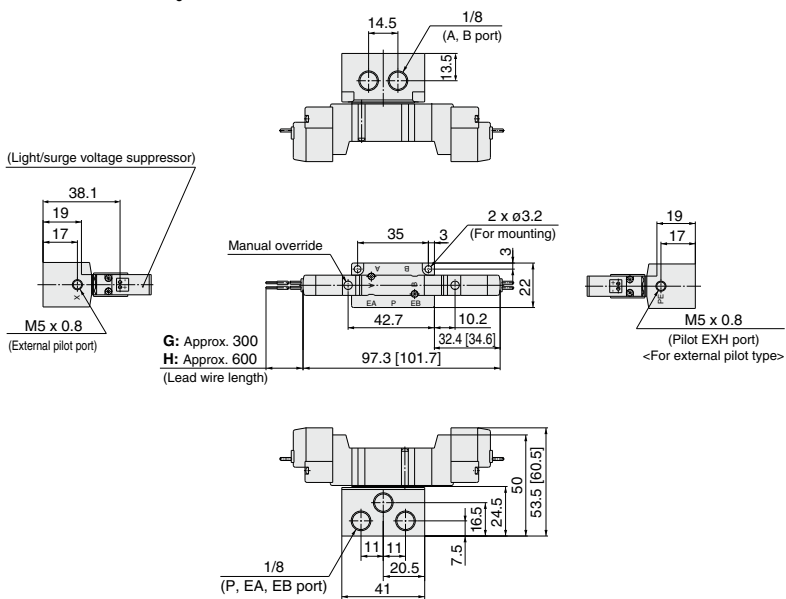

L plug connector (L):
10-SY3 $\frac{3}{4}$ 40(R)-□L□□-01□

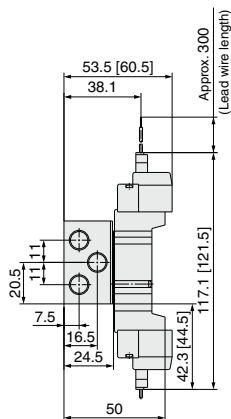

M plug connector (M):
10-SY3 $\frac{3}{4}$ 40(R)-□M□□-01□

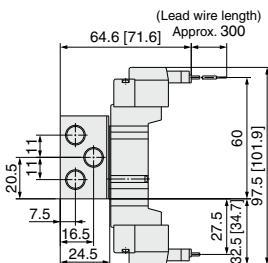

M8 connector (WO):
10-SY3 $\frac{3}{4}$ 40(R)-□WO□□-01□

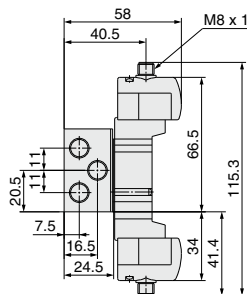

Note) Refer to page 176 for dimensions of connector types.

Dimensions: Series 10-SY5000

[] : AC

2 position single

Grommet (G), (H): 10-SY5140(R)-□_G□□-02□

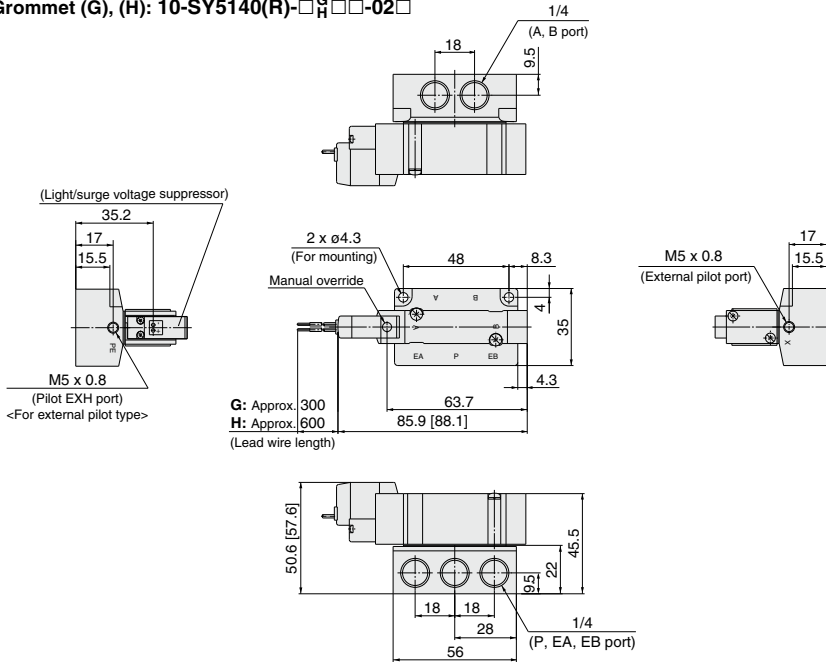

L plug connector (L):
10-SY5140(R)-□L□□-02□

M plug connector (M):
10-SY5140(R)-□M□□-02□

DIN terminal (D, Y):
10-SY5140(R)-□_D□□-02□

M8 connector (WO):
10-SY5140(R)-□WO□□-02□

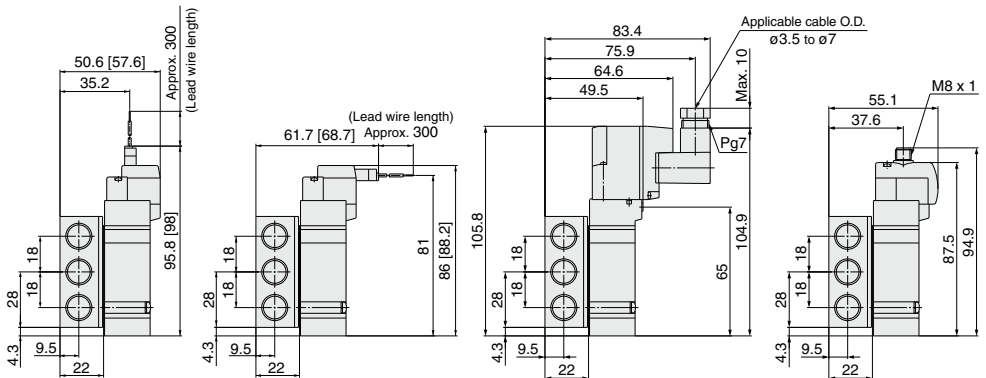

Note) Refer to page 176 for dimensions of connector types.

Dimensions: Series 10-SY5000

[]: AC

2 position double

Grommet (G), (H): 10-SY5240(R)-□^G□□-02□

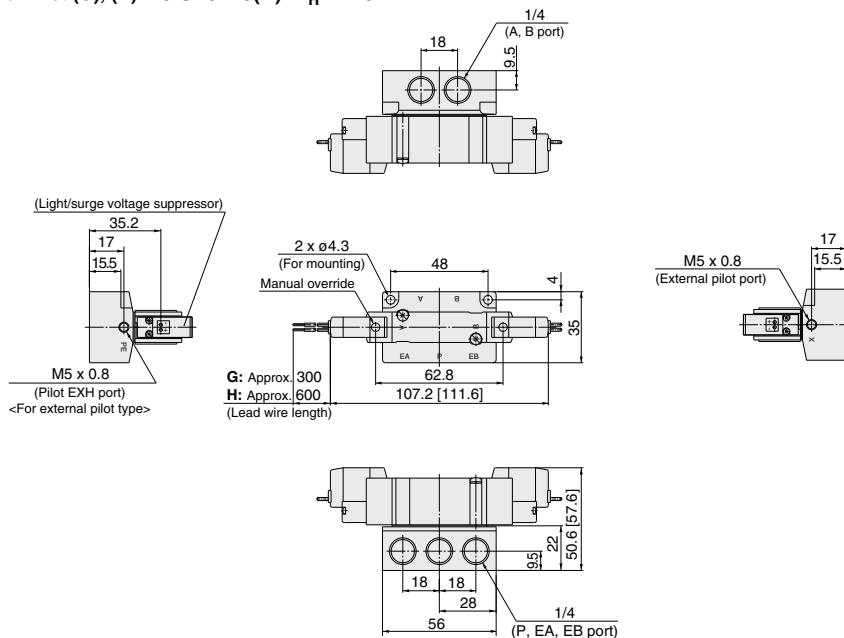

L plug connector (L):
10-SY5240(R)-□L□□-02□

M plug connector (M):
10-SY5240(R)-□M□□-02□

DIN terminal (D, Y):
10-SY5240(R)-□^D□□-02□

M8 connector (WO):
10-SY5240(R)-□WO□□-02□

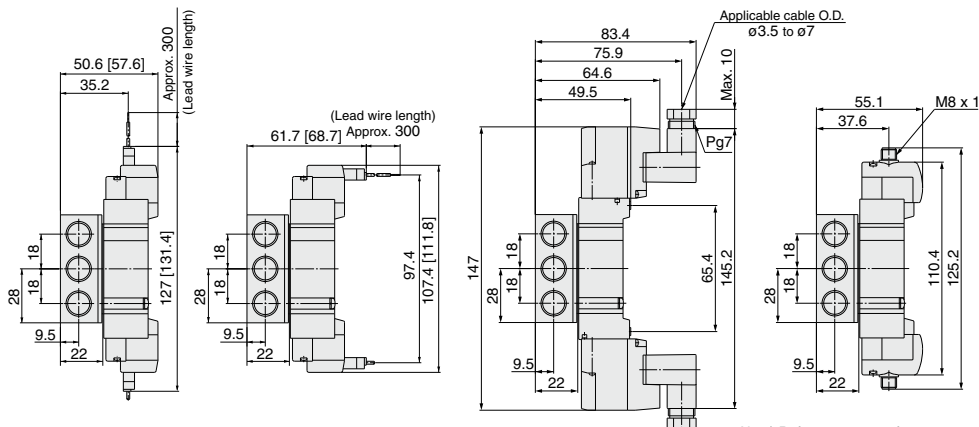

Note) Refer to page 176 for dimensions of connector types.

Dimensions: Series 10-SY5000

[] : AC

3 position closed center / exhaust center / pressure center

Grommet (G), (H): 10-SY5 $\frac{3}{4}$ 40(R)-□ $\frac{G}{H}$ □□-02□

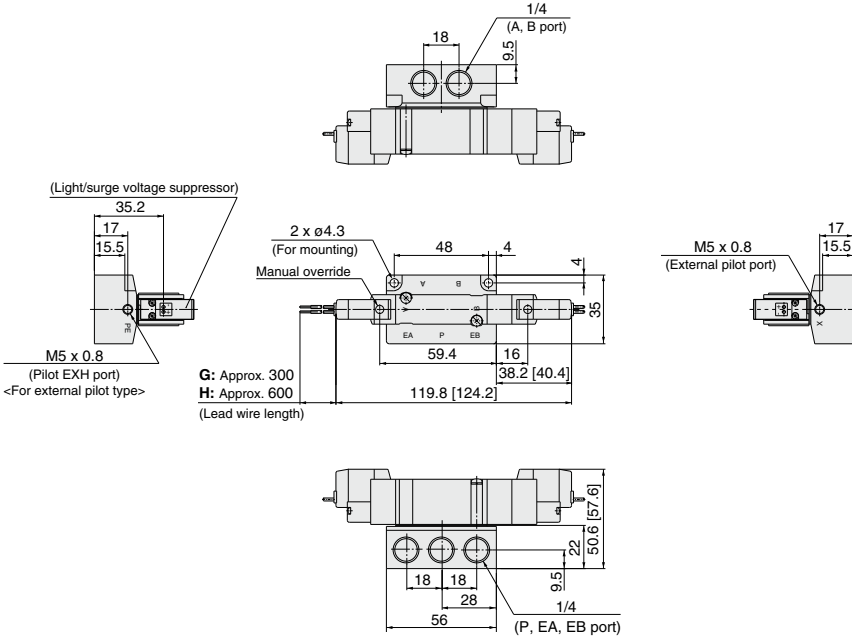

L plug connector (L):

10-SY5 $\frac{3}{4}$ 40(R)-□□□-02□

M plug connector (M):

10-SY5 $\frac{3}{4}$ 40(R)-□M□□-02□

DIN terminal (D, Y):

10-SY5 $\frac{3}{4}$ 40(R)-□ $\frac{D}{Y}$ □□-02□

M8 connector (WO):

10-SY5 $\frac{3}{4}$ 40(R)-□WO□□-02□

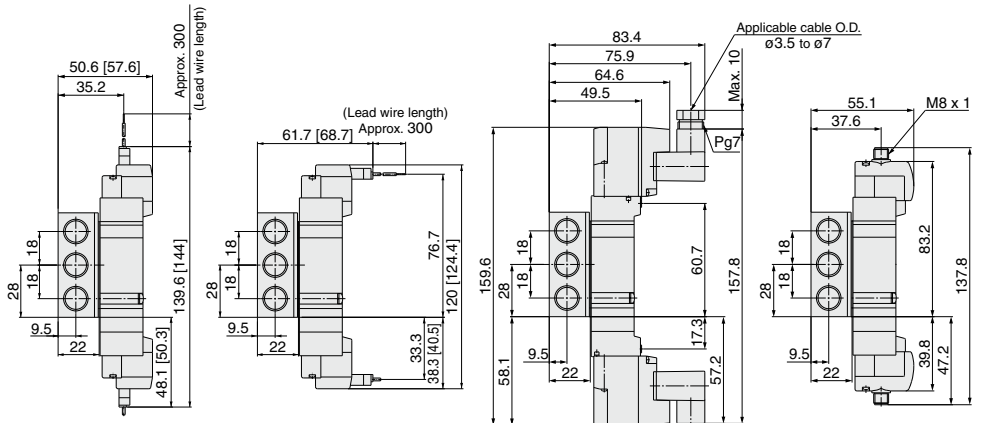

Note) Refer to page 176 for dimensions of connector types.

Dimensions: Series 10-SY7000

[] : AC

2 position single

Grommet (G), (H): 10-SY7140(R)-□_G□□-02□_H□□-03□

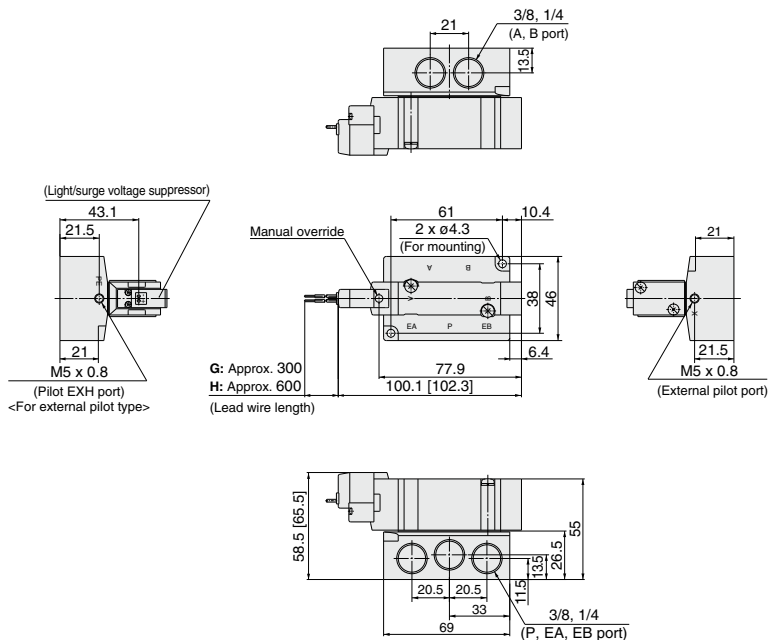

L plug connector (L):
10-SY7140(R)-□L□□-02□₀₃□

M plug connector (M):
10-SY7140(R)-□M□□-02□₀₃□

DIN terminal (D, Y):
10-SY7140(R)-□D□□-02□₀₃□

M8 connector (WO):
10-SY7140(R)-□WO□□-02□₀₃□

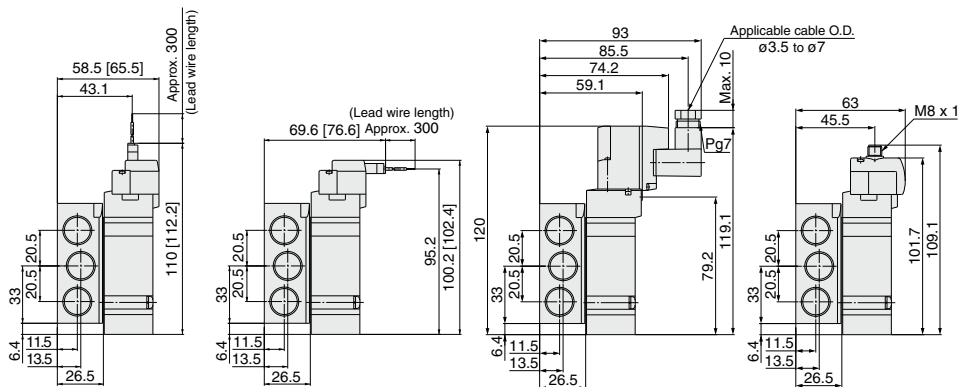

Note) Refer to page 176 for dimensions of connector types.

Dimensions: Series 10-SY7000

[]: AC

2 position double

Grommet (G), (H): 10-SY7240(R)-□G□□□□.02□□
□H□□□□.03□□

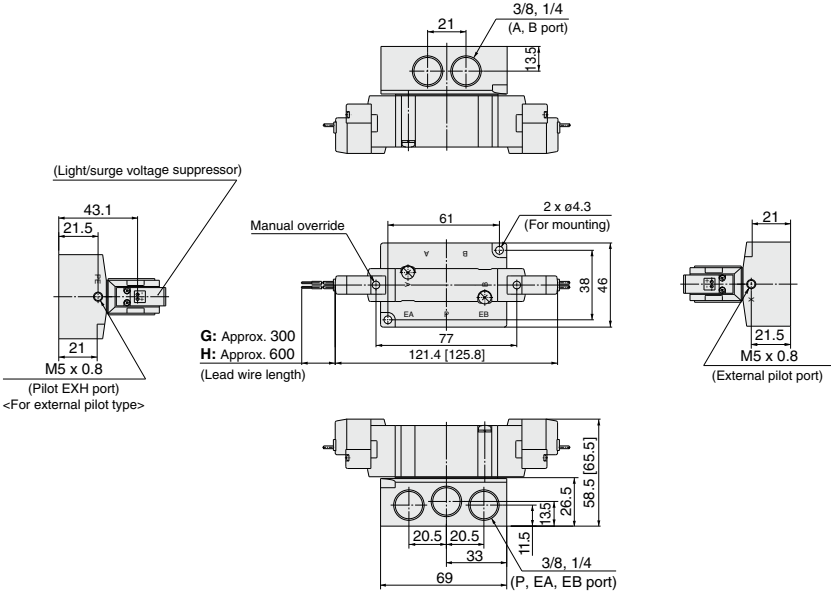

L plug connector (L):
10-SY7240(R)-□L□□□□.02□□

M plug connector (M):
10-SY7240(R)-□M□□□□.02□□

DIN terminal (D, Y):
10-SY7240(R)-□D□□□□.02□□

M8 connector (WO):
10-SY7240(R)-□WO□□□□.02□□

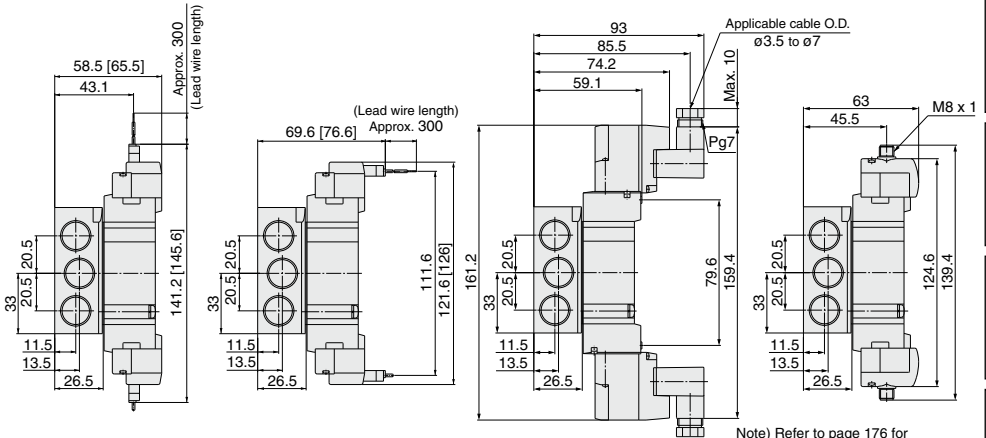

Directional Control Valves
Air Cylinders
Rotary Actuators
Air Grippers
Air Preparation Equipment
Modular F. R.
Pressure Control Equipment
Fittings & Tubing
Flow Control Equipment
Pressure Switches/ Pressure Sensors

Dimensions: Series 10-SY7000

[] : AC

3 position closed center / exhaust center / pressure center

Grommet (G), (H): 10-SY7 $\frac{3}{4}$ 40(R)-□ $\frac{G}{H}$ □□-02□□ $\frac{03}{03}$

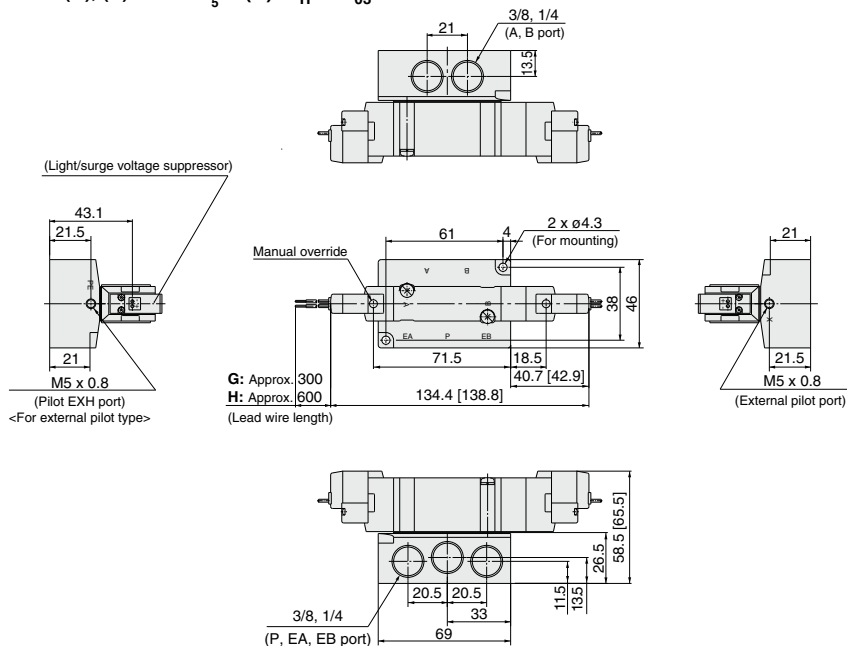

L plug connector (L):
 10-SY7 $\frac{3}{4}$ 40(R)-□□□□-02□□ $\frac{03}{03}$

M plug connector (M):
 10-SY7 $\frac{3}{4}$ 40(R)-□M□□-02□□ $\frac{03}{03}$

DIN terminal (D, Y):
 10-SY7 $\frac{3}{4}$ 40(R)-□ $\frac{D}{Y}$ □□-02□□ $\frac{03}{03}$

M8 connector (WO):
 10-SY7 $\frac{3}{4}$ 40(R)-□WO□□-02□□ $\frac{03}{03}$

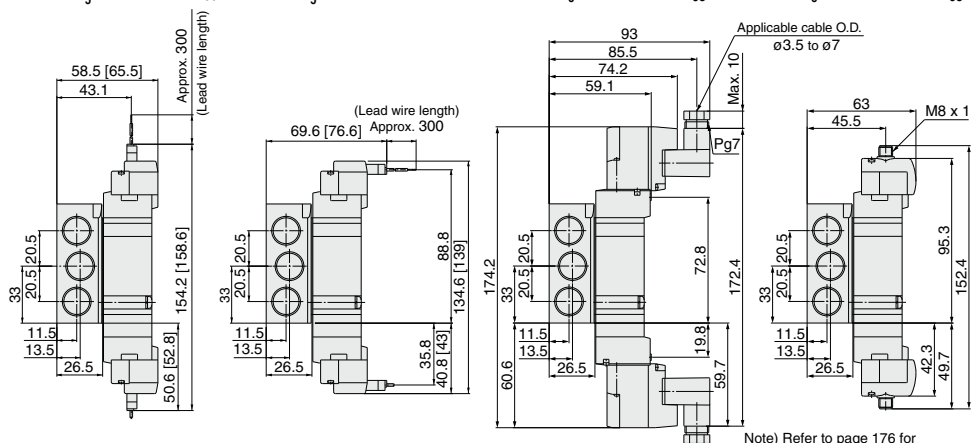

Dimensions: Series 10-SY9000

[] : AC

2 position single

Grommet (G), (H): 10-SY9140(R)-□_G□□-03□₀₄

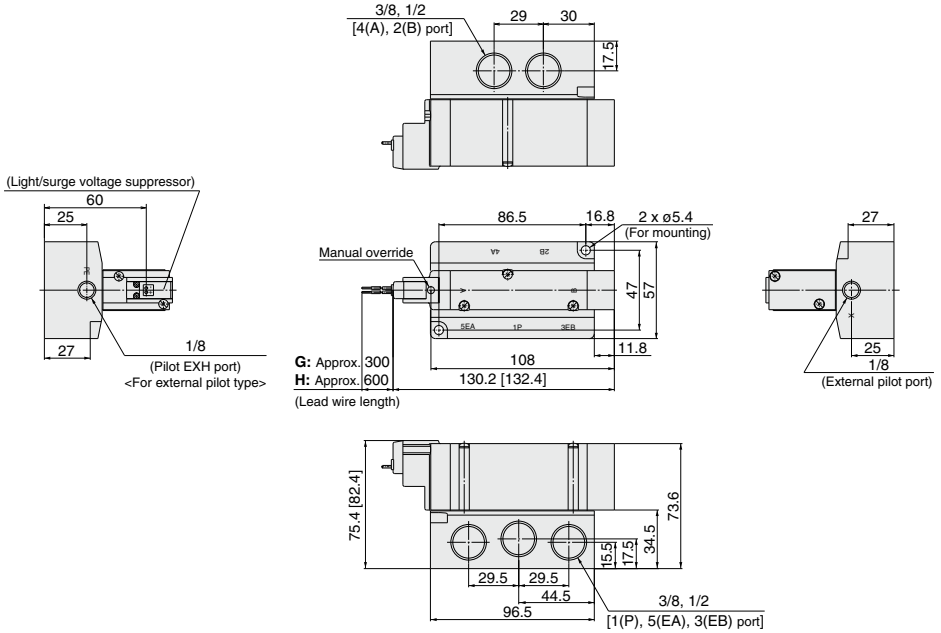

L plug connector (L):
10-SY9140(R)-□L□□-03□₀₄

M plug connector (M):
10-SY9140(R)-□M□□-03□₀₄

DIN terminal (D, Y):
10-SY9140(R)-□_D□_Y□□-03□₀₄

M8 connector (WO):
10-SY9140(R)-□WO□□-03□₀₄

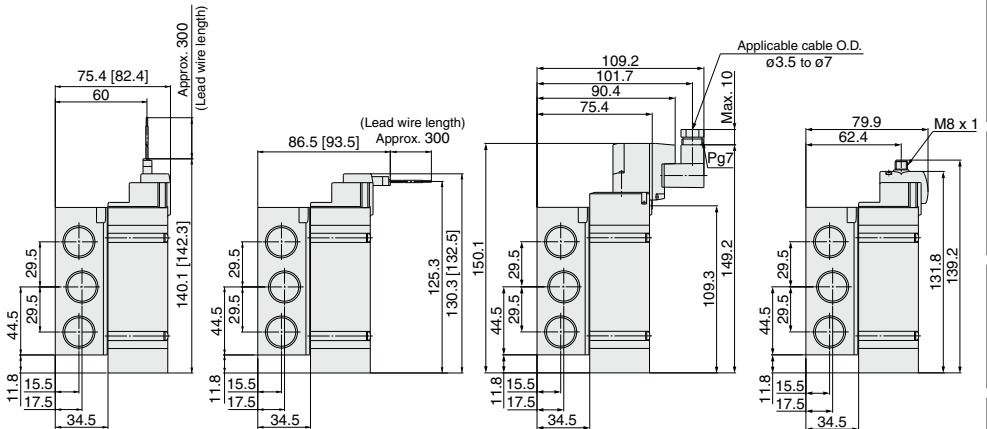

Note) Refer to page 176 for dimensions of connector types.

Directional Control Valves
Air Cylinders
Rotary Actuators
Air Grippers
Air Preparation Equipment
Modular F. R.
Pressure Control Equipment
Fittings & Tubing
Flow Control Equipment
Pressure Switches/Pressure Sensors

Dimensions: Series 10-SY9000

[]: AC

2 position double

Grommet (G), (H): 10-SY9240(R)-□□□□-03□□

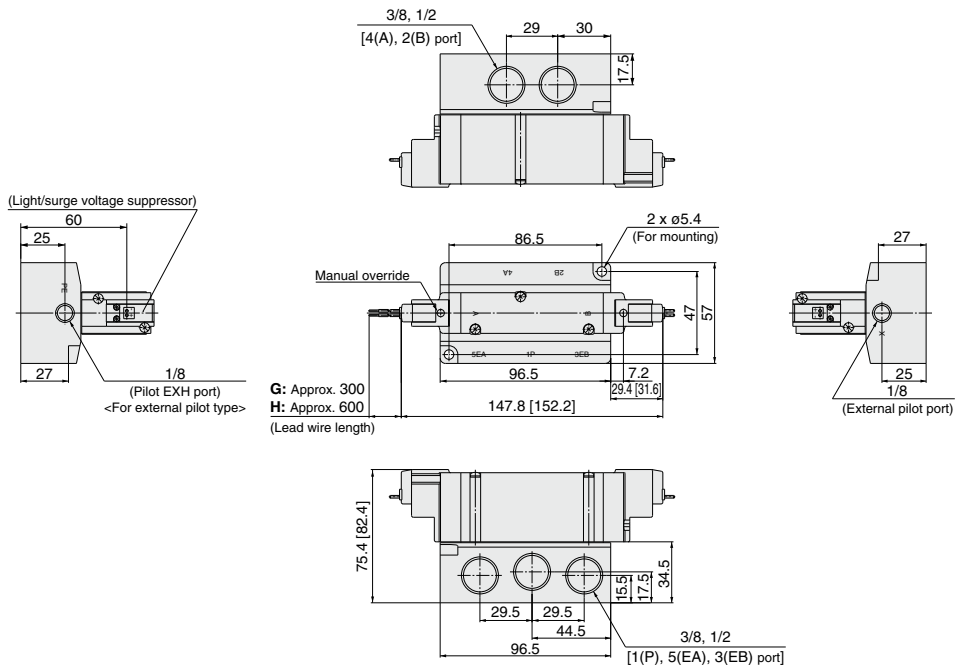

L plug connector (L):
10-SY9240(R)-□□□□-03□□

M plug connector (M):
10-SY9240(R)-□□□□-03□□

DIN terminal (D, Y):
10-SY9240(R)-□□□□-03□□

M8 connector (WO):
10-SY9240(R)-□□□□-03□□

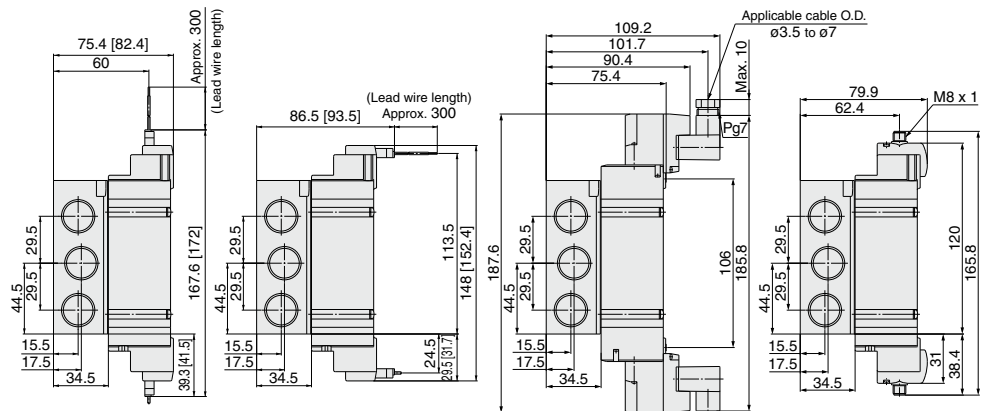

Note) Refer to page 176 for dimensions of connector types.

Dimensions: Series 10-SY9000

[]: AC

3 position closed center / exhaust center / pressure center

Grommet (G), (H): 10-SY9³/₅40(R)-□□□□-⁰³/₀₄□

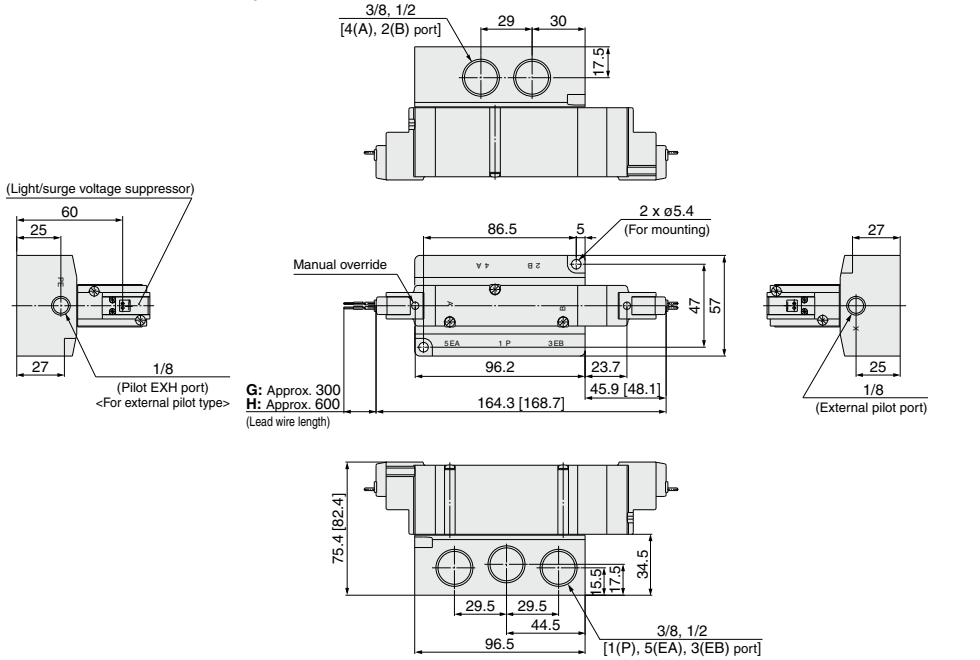

L plug connector (L): 10-SY9³/₅40(R)-□□□□-⁰³/₀₄□

M plug connector (M): 10-SY9³/₅40(R)-□□□□-⁰³/₀₄□

DIN terminal (D, Y): 10-SY9³/₅40(R)-□□□□-⁰³/₀₄□

M8 connector (WO): 10-SY9³/₅40(R)-□□□□-⁰³/₀₄□

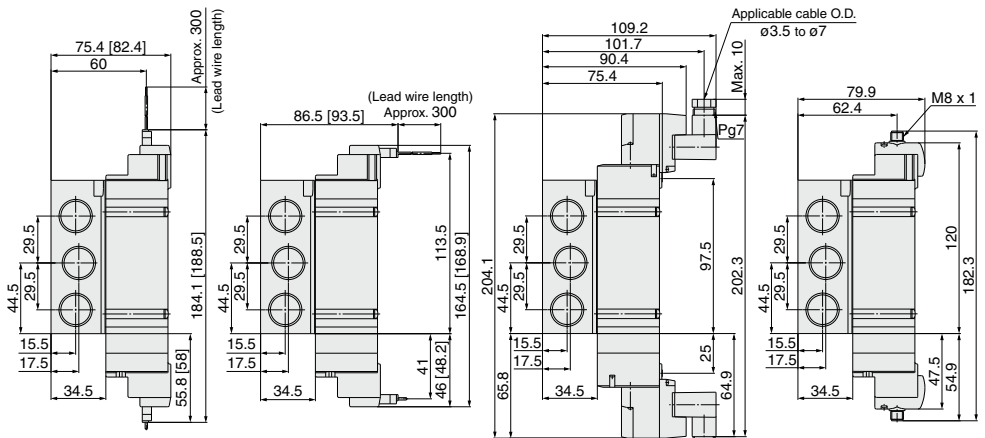

Note) Refer to page 176 for dimensions of connector types.

Directional Control Valves
 Air Cylinders
 Rotary Actuators
 Air Grippers
 Air Preparation Equipment
 Modular F. R.
 Pressure Control Equipment
 Fittings & Tubing
 Flow Control Equipment
 Pressure Switches/ Pressure Sensors

Type 20 Series 10-SY3000/5000/7000

5 Port Solenoid Valve
Body Ported Manifold
Bar Stock Type/Individual Wiring



How to Order Manifold

10 - SS5Y 5 - 20 - 05 - [] - []

• Clean series

Manifold series

3	10-SY3000
5	10-SY5000
7	10-SY7000

Stations

02	2 stations
:	:
20	20 stations

* Includes the number of blanking plate assemblies.

Thread type

NII	Rc
00F	G
00N	NPT
00T	NPTF

CE-compliant

NII	—
Q	CE-compliant

Note) AC-type models that are CE-compliant have DIN terminals only.

How to Order Manifold Assembly (Example)

Example

Cylinder port size

C6: With ø6 One-touch fitting

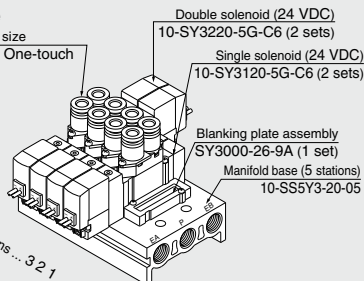

- 10-SS5Y3-20-05 1 set (Type 20, 5-station manifold base part no.)
- * SY3000-26-9A 1 set (Blanking plate assembly part no.)
- * 10-SY3120-5G-C6 ... 2 sets (Single solenoid part no.)
- * 10-SY3220-5G-C6 ... 2 sets (Double solenoid part no.)

The asterisk denotes the symbol for assembly. Prefix it to the part no. of the solenoid valve, etc.

Add the valve and option part number under the manifold base part number. For complex arrangements, specify them on the manifold specification sheet.



How to Order Valve

Note) AC-type models that are CE-compliant have DIN terminals only.

[Option]

10-SY 5 1 20 [] - **5 L** [] [] - **01** [] [] []

• **Clean series**

• **Series**

3	10-SY3000
5	10-SY5000
7	10-SY7000

• **Actuation type**

1	2 position single
2	2 position double
3	3 position closed center
4	3 position exhaust center
5	3 position pressure center

• **Coil type**

Nil	Standard
T	With power saving circuit (24 VDC, 12 VDC only)

* Power saving circuit is not available for D, Y, DO, YO or W□ types.

• **Rated voltage**

For DC

For AC (50/60 Hz)

5	24 VDC	1	100 VAC
6	12 VDC	2	200 VAC
V	6 VDC	3	110 VAC [115 VAC]
S	5 VDC	4	220 VAC [230 VAC]
R	3 VDC		

* DC specifications of type D, Y, DO and YO are only available with 12 and 24 VDC.
 * For type W□, only DC voltage is available.
 Note) AC-type models that are CE-compliant have DIN terminals only.

• **Manual override**

Nil	Non-locking push type
D	Push-turn locking slotted type
E	Push-turn locking lever type

• **Light/Surge voltage suppressor**

Electrical entry for G, H, L, M, W

Nil	Without light/surge voltage suppressor
S	With surge voltage suppressor
Z	With light/surge voltage suppressor
R	With surge voltage suppressor (Non-polar type)
U	With light/surge voltage suppressor (Non-polar type)

* For AC voltage valves there is no "S" option. It is already built into the rectifier circuit.
 * For "R" and "U", only DC voltage is available.
 * Power saving circuit is only available for the "Z" type.

• **Electrical entry for D, Y**

Nil	Without light/surge voltage suppressor
S	With surge voltage suppressor (Non-polar type)
Z	With light/surge voltage suppressor (Non-polar type)

* DOZ and YOZ are not available.
 * For AC voltage valves there is no "S" option. It is already built into the rectifier circuit.

• **Made to Order**

Nil	—
X90	Main valve fluororubber (Refer to page 169.)

• **CE-compliant**

Nil	—
Q	CE-compliant

Note) AC-type models that are CE-compliant have DIN terminals only.

• **A, B port size Thread piping**

Symbol	Port size	Applicable series
M5	M5 x 0.8	10-SY3000
01	1/8	10-SY5000
02	1/4	10-SY7000

• **One-touch fitting (Metric size)**

Symbol	Port size	Applicable series
C4	ø4 One-touch fitting	10-SY3000
C6	ø6 One-touch fitting	10-SY5000
C4	ø4 One-touch fitting	10-SY5000
C6	ø6 One-touch fitting	10-SY5000
C8	ø8 One-touch fitting	10-SY7000
C8	ø8 One-touch fitting	10-SY7000
C10	ø10 One-touch fitting	10-SY7000

• **One-touch fitting (Inch size)**

Symbol	Port size	Applicable series
N3	ø3/8 One-touch fitting	10-SY3000
N7	ø1/4 One-touch fitting	10-SY3000
N3	ø3/8 One-touch fitting	10-SY5000
N7	ø1/4 One-touch fitting	10-SY5000
N9	ø5/16 One-touch fitting	10-SY5000
N9	ø5/16 One-touch fitting	10-SY7000
N11	ø3/8 One-touch fitting	10-SY7000

Note) When placing an order for body ported solenoid valves as a single unit, the mounting screws for the manifold and gasket are not attached. Order them separately, if necessary.

■ Gasket assembly part no.

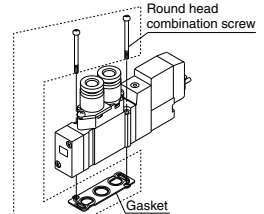

Series	Gasket assembly part no.
10-SY3000	SY3000-GS-1
10-SY5000	SY5000-GS-1
10-SY7000	SY7000-GS-1

Note) The gasket assembly consists of 10 sets of mounting screws and a gasket.

• **Electrical entry**

		24, 12, 6, 5, 3 VDC/ 100, 110, 200, 220 VAC			24, 12 VDC/ 100, 110, 200, 220 VAC	24, 12, 6, 5, 3 VDC
		Grommet	L plug connector	M plug connector	DIN terminal	M8 connector
Manifold mounting	10-SY3000	●	●	●	— Note 1)	●
	10-SY5000	●	●	●	●	●
	10-SY7000	●	●	●	●	●
CE-compliant	DC	●	●	●	●	●
	AC	—	—	—	●	—

Note 1) The DIN terminal of the 10-SY3000 series cannot be mounted on a standard manifold. For details, refer to page 174.

Note 2) Enter the cable length symbols in □. Please be sure to fill in the blank referring to page 176.

* LN, MN type: With 2 sockets.

* "Y" type is a DIN terminal conforming to EN-175301-803C (former DIN43850C).

For details, refer to page 173.

* For connector cable of M8 connector, refer to page 176.

* M8 connector conforming to IEC60947-5-2 standard is also available. Refer to page 168 for details.

* Refer to page 173 for the lead wire length of L and M plug connectors.

* Refer to page 174 for the connector assembly with cover for L and M plug connectors.



Directional Control Valves

Air Cylinders

Rotary Actuators

Air Grippers

Air Preparation Equipment

Modular F. R.

Pressure Control Equipment

Fittings & Tubing

Flow Control Equipment

Pressure Switches/ Pressure Sensors

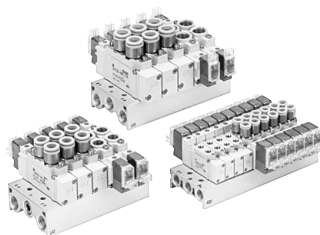

Manifold Specifications

Model	10-SS5Y3-20(-Q)	10-SS5Y5-20(-Q)	10-SS5Y7-20(-Q)	
Applicable valve	10-SY3□20	10-SY5□20	10-SY7□20	
Manifold type	Single base/B mount			
P (SUP)/R (EXH)	Common SUP, Common EXH			
Valve stations	2 to 20 stations ^{Note 1)}			
A, B port location	Valve			
Port size	P, EA, EB port	1/8	1/4	1/4
	A, B port	M5 x 0.8	1/8	1/4
		C4 (ø4 One-touch fitting) C6 (ø6 One-touch fitting)	C4 (ø4 One-touch fitting) C6 (ø6 One-touch fitting) C8 (ø8 One-touch fitting)	C8 (ø8 One-touch fitting) C10 (ø10 One-touch fitting)
Manifold base weight W (g)	W = 13n + 24	W = 36n + 64	W = 43n + 35	
n: Stations				

Note 1) For more than 10 stations (more than 5 stations in case of 10-SS5Y7), supply pressure to P port on both sides and exhaust from EA/EB port on both sides.

Note 2) Refer to "Manifold Option" on page 100.

Flow Rate Characteristics

Model	Port size		Flow rate characteristics					
	1, 5, 3 (P, EA, EB)	4, 2 (A, B)	1 → 4/2 (P → A/B)			4/2 → 5/3 (A/B → EA/EB)		
			C (dm ³ /(s·bar))	b	Cv	C (dm ³ /(s·bar))	b	Cv
10-SS5Y3-20(-Q)	1/8	C6	0.72	0.29	0.18	0.80	0.36	0.21
10-SS5Y5-20(-Q)	1/4	C8	1.9	0.28	0.48	2.2	0.20	0.53
10-SS5Y7-20(-Q)	1/4	C10	3.6	0.31	0.93	3.6	0.27	0.88

Note) The values are for individually operated 2 position type manifold bases with 5 stations.

10-SY3000: 10-SS5Y3-20-Stations -

[] : AC

Grommet (G)

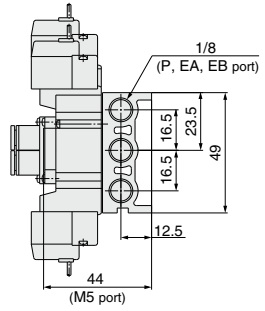
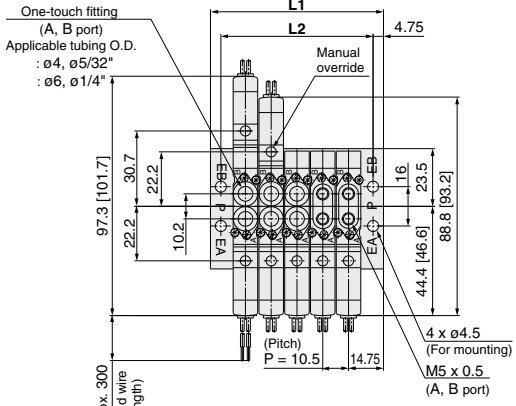

(Station n) ----- (Station 1)

Dimensions when mounting individual EXH spacer

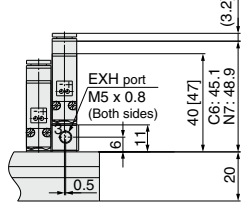

Dimensions when mounting individual SUP spacer

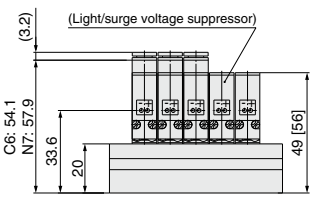
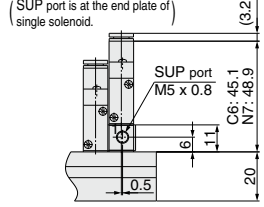

L plug connector (L)

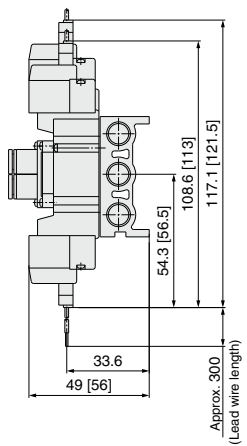

M plug connector (M)

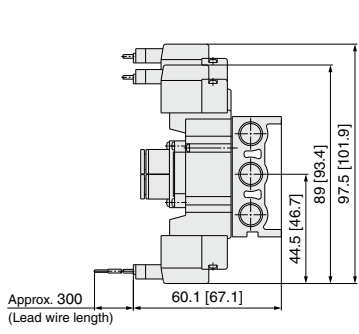

M8 connector (WO)

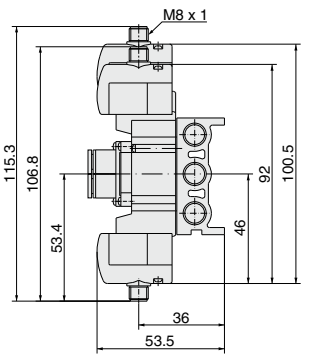

Note) Refer to page 176 for dimensions of connector types.

Stations	2 stations	3	4	5	6	7	8	9	10	11	12	13	14	15	16	17	18	19	20 stations
L1	40	50.5	61	71.5	82	92.5	103	113.5	124	134.5	145	155.5	166	176.5	187	197.5	208	218.5	229
L2	30.5	41	51.5	62	72.5	83	93.5	104	114.5	125	135.5	146	156.5	167	177.5	188	198.5	209	219.5

- Directional Control Valves
- Air Cylinders
- Rotary Actuators
- Air Grippers
- Air Preparation Equipment
- Modular F. R.
- Pressure Control Equipment
- Fittings & Tubing
- Flow Control Equipment
- Pressure Switches/Pressure Sensors

10-SY5000: 10-SS5Y5-20-Stations -

[] : AC

Grommet (G)

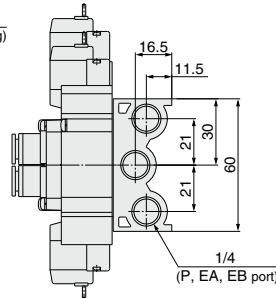
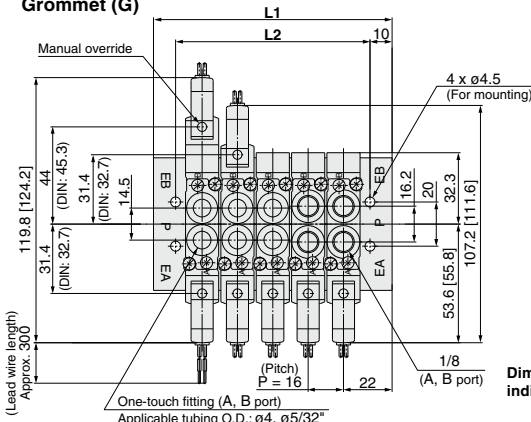

Dimensions when mounting individual EXH spacer

Dimensions when mounting individual SUP spacer

(SUP port is at the end plate of single solenoid.)

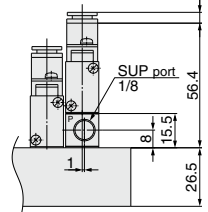
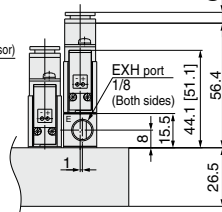
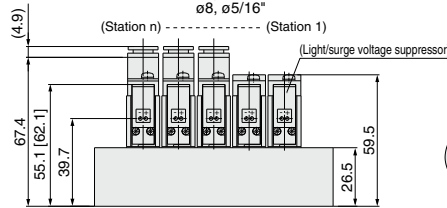

L plug connector (L)

M plug connector (M)

DIN terminal (D, Y)

M8 connector (WO)

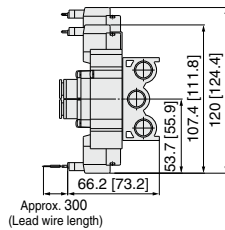
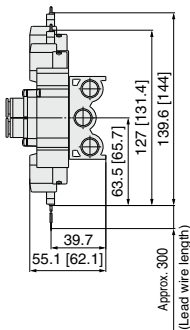

Applicable cable O.D.
ø3.5 to ø7

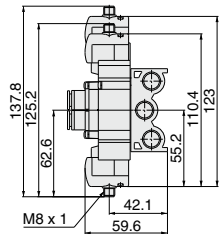
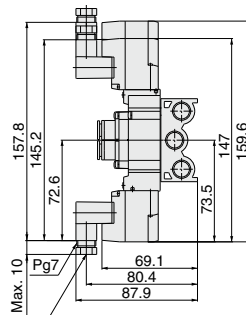

Note) Refer to page 176 for dimensions of connector types.

Stations	2 stations	3	4	5	6	7	8	9	10	11	12	13	14	15	16	17	18	19	20 stations
L1	60	76	92	108	124	140	156	172	188	204	220	236	252	268	284	300	316	332	348
L2	40	56	72	88	104	120	136	152	168	184	200	216	232	248	264	280	296	312	328

10-SY7000: 10-SS5Y7-20-Stations - [] : AC

Grommet (G)

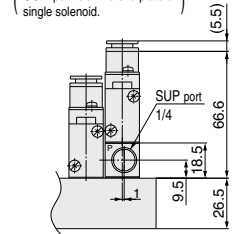
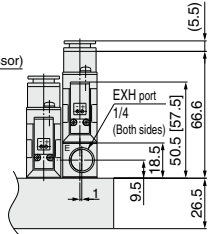
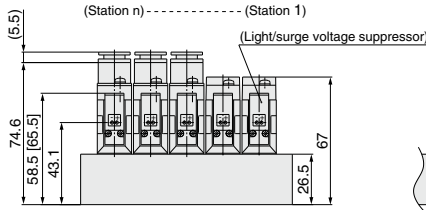
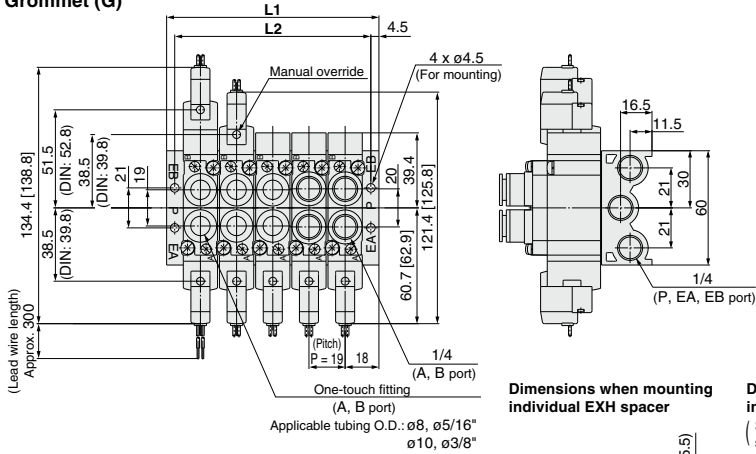

L plug connector (L)

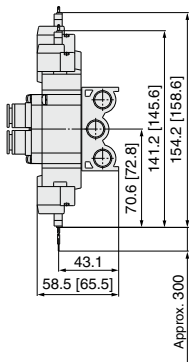

M plug connector (M)

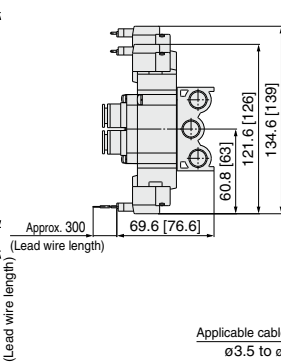

DIN terminal (D, Y)

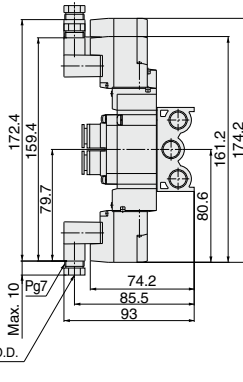

M8 connector (WO)

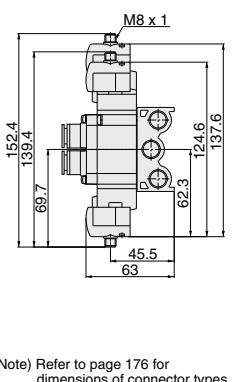

Stations	2 stations	3	4	5	6	7	8	8	10	11	12	13	14	15	16	17	18	19	20 stations
L1	55	74	93	112	131	150	169	188	207	226	245	264	283	302	321	340	359	378	397
L2	46	65	84	103	122	141	160	179	198	217	236	255	274	293	312	331	350	369	388

Directional Control Valves
Air Cylinders
Rotary Actuators
Air Grippers
Air Preparation Equipment
Modular F. R.
Pressure Control Equipment
Fittings & Tubing
Flow Control Equipment
Pressure Switches/
Pressure Sensors

Type 23 Series 10-SY9000

5 Port Solenoid Valve
Body Ported Manifold
Stacking Type/Individual Wiring



How to Order Manifold

Type 23/Common external pilot

10-SS5Y9-23-05-□-□-□

• Clean series

Manifold series
9 10-SY9000

• Valve stations

Symbol	Stations
02	2 stations
⋮	⋮
20	20 stations

* Includes the number of blanking plate assemblies.

• Thread type

NII	Rc
00F	G
00N	NPT
00T	NPTF

• Option

Symbol	Mounting
NII	Direct mounting
D	DIN rail mounting (with DIN rail)
DO	DIN rail mounting (without DIN rail)
D*	When a longer DIN rail is desired than the specified stations, specify the station number to be required in place of the * mark.

• CE-compliant

NII	—
Q	CE-compliant

Note) AC-type models that are CE-compliant have DIN terminals only.

How to Order Manifold Assembly (Example)

Example

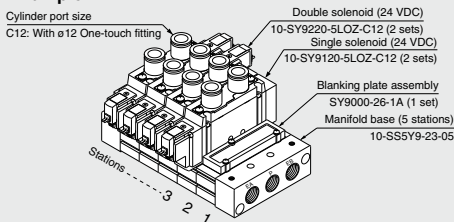

10-SS5Y9-23-05 1 set (Type 23, 5-station manifold base part no.)
 * SY9000-26-1A 1 set (Blanking plate assembly part no.)
 * 10-SY9120-5LOZ-C12 ... 2 sets (Single solenoid part no.)
 * 10-SY9220-5LOZ-C12 ... 2 sets (Double solenoid part no.)

The asterisk denotes the symbol for assembly. Prefix it to the part no. of the solenoid valve, etc.

Add the valve and option part number under the manifold base part number. For complex arrangements, specify them on the manifold specification sheet.



How to Order Valve

Note) AC-type models that are CE-compliant have DIN terminals only. [Option]

10 - SY 9 1 20 - 5 L - 02 - - -

• Clean series

Series

9	10-SY9000
---	-----------

• Actuation type

1	2 position single
2	2 position double
3	3 position closed center
4	3 position exhaust center
5	3 position pressure center

• Pilot type

NII	Internal pilot
R	External pilot

* For external pilot specifications, it cannot be used as a single unit.

• Coil type

NII	Standard
T	With power saving circuit (24 VDC, 12 VDC only)

* Power saving circuit is not available for D, Y, DO, YO or WC types.

• Rated voltage

For DC

5	24 VDC
6	12 VDC
V	6 VDC
S	5 VDC
R	3 VDC

* DC specifications of type D, Y, DO and YO are only available with 12 and 24 VDC.

* For type WC, only DC voltage is available.

Note) AC-type models that are CE-compliant have DIN terminals only.

For AC (%Hz)

1	100 VAC
2	200 VAC
3	110 VAC [115 VAC]
4	220 VAC [230 VAC]

• Made to Order

NII	—
X90	Main valve fluororubber (Refer to page 169.)

• Thread type

NII	Rc
F	G
N	NPT
T	NPTF

• CE-compliant

NII	—
Q	CE-compliant

Note) AC-type models that are CE-compliant have DIN terminals only.

• Manual override

NII	Non-locking push type
D	Push-turn locking slotted type
E	Push-turn locking lever type

• Light/Surge voltage suppressor
Electrical entry for G, H, L, M, W

NII	Without light/surge voltage suppressor
S	With surge voltage suppressor
Z	With light/surge voltage suppressor
R	With surge voltage suppressor (Non-polar type)
U	With light/surge voltage suppressor (Non-polar type)

* For AC voltage valves there is no "S" option. It is already built into the rectifier circuit.
* For "R" and "U", only DC voltage is available.
* Power saving circuit is only available for the "Z" type.

• Electrical entry for D, Y

NII	Without light/surge voltage suppressor
S	With surge voltage suppressor
Z	With light/surge voltage suppressor

* DOZ and YOZ are not available.
* For AC voltage valves there is no "S" option. It is already built into the rectifier circuit.

• A, B port size
Thread piping

Symbol	Port size
02	1/4
03	3/8

• One-touch fitting (Metric size)

Symbol	Port size
C8	ø8 One-touch fitting
C10	ø10 One-touch fitting
C12	ø12 One-touch fitting

• One-touch fitting (Inch size)

Symbol	Port size
N9	ø 5/16" One-touch fitting
N11	ø 3/8" One-touch fitting

• Electrical entry

	24, 12, 6, 5, 3 VDC / 100, 110, 200, 220 VAC			24, 12 VDC / 100, 110, 200, 220 VAC	24, 12, 6, 5, 3 VDC
	Grommet	L plug connector	M plug connector	DIN terminal	M8 connector
	G: Lead wire length 300 mm H: Lead wire length 600 mm	L: With lead wire (Length 300 mm) LN: Without lead wire LO: Without connector	M: With lead wire (Length 300 mm) MN: Without lead wire MO: Without connector	D: With connector DC: Without connector Y: With connector YO: Without connector	WC: Without connector cable WC: With connector cable (Note)
CE-compliant	DC	●	●	●	●
	AC	—	—	●	—

* LN, MN type: With 2 sockets.

* "Y" type is a DIN terminal conforming to EN-175301-803C (former DIN43650C). For details, refer to page 173.

* For connector cable of M8 connector, refer to page 176.

* M8 connector conforming to IEC60947-5-2 standard is also available. Refer to page 168 for details.

* Refer to page 173 for the lead wire length of L and M plug connectors.

* Refer to page 174 for the connector assembly with cover for L and M plug connectors.

Note) Enter the cable length symbols in □. Please be sure to fill in the blank referring to page 176.

Note) When placing an order for body ported solenoid valves as a single unit, the mounting screws for the manifold and gasket are not attached. Order them separately, if necessary.

■ Gasket assembly part no.

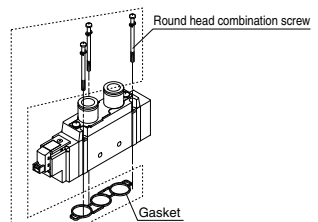

Series	Gasket assembly part no.
10-SY9000	SY9000-GS-1

Note) The gasket assembly consists of 10 sets of mounting screws and a gasket.

Directional Control Valves

Air Cylinders

Rotary Actuators

Air Grippers

Air Preparation Equipment

Modular F. R.

Pressure Control Equipment

Fittings & Tubing

Flow Control Equipment

Pressure Switches/Pressure Sensors

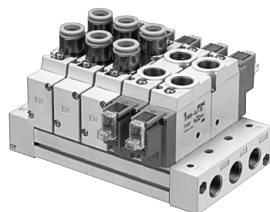

Manifold Specifications

Model	10-SS5Y9-23(-Q)	
Applicable valve	10-SY9□20	
Manifold type	Stacking type	
P (SUP)/R (EXH)	Common SUP, Common EXH	
Valve stations	2 to 20 stations ^{Note 1)}	
A, B port location	Valve	
Port size	P, EA, EB port	3/8
	A, B port	1/4
		3/8
		C8 (ø8 One-touch fitting) C10 (ø10 One-touch fitting) C12 (ø12 One-touch fitting)
Manifold base weight W (g) n: Stations	W = 66n + 246	

Note 1) For more than 10 stations, supply pressure to P port on both sides and exhaust from EA/EB port on both sides.

Note 2) Refer to "Manifold Option" on page 100.

Flow Rate Characteristics

Model	Port size		Flow rate characteristics					
	1, 5, 3 (P, EA, EB)	4, 2 (A, B)	1 → 4/2 (P → A/B)			4/2 → 5/3 (A/B → EA/EB)		
			C (dm ³ /s·bar)	b	Cv	C (dm ³ /s·bar)	b	Cv
10-SS5Y9-23(-Q)	3/8	C12	6.3	0.20	1.5	8.2	0.28	1.9

Note) The values are for individually operated 2 position type manifold bases with 5 stations.

10-SY9000: 10-SS5Y9-23-Stations-(D)

[]: AC

Grommet (G)

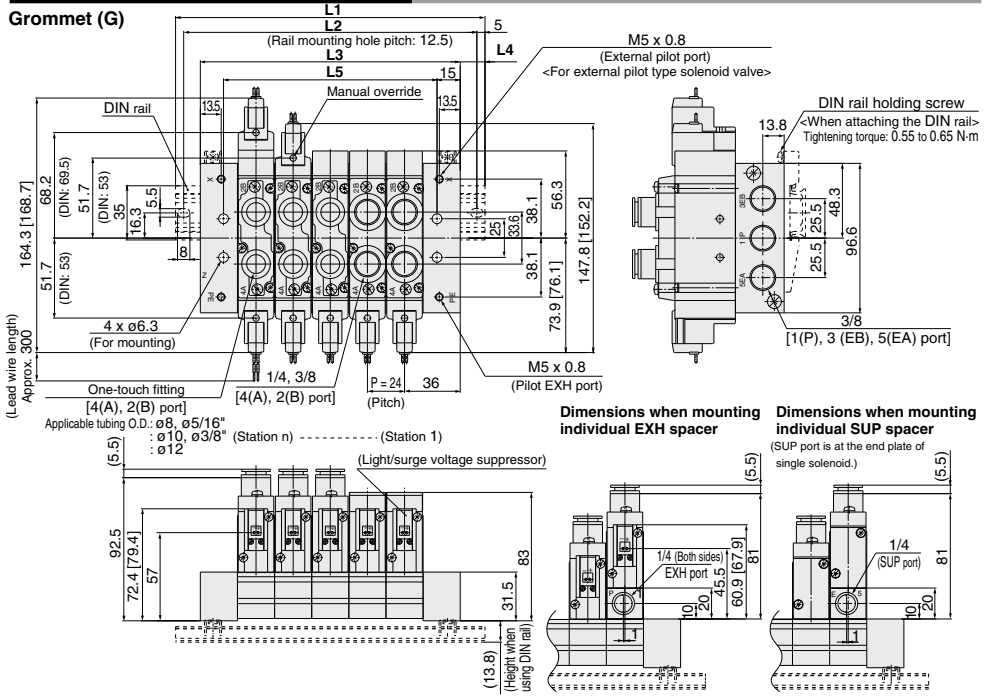

L plug connector (L)

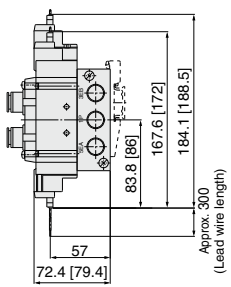

M plug connector (M)

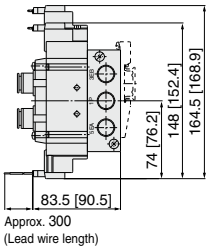

DIN terminal (D, Y)

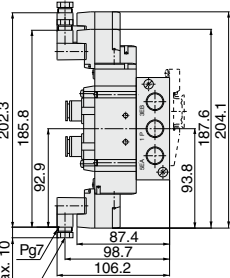

M8 connector (WO)

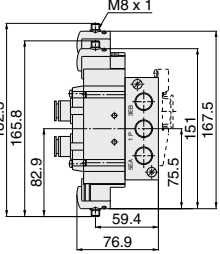

Note) Refer to page 176 for dimensions of connector types.

Stations	2 stations	3	4	5	6	7	8	9	10	11	12	13	14	15	16	17	18	19	20 stations
L1	123	148	173	198	223	248	273	298	323	335.5	360.5	385.5	410.5	435.5	460.5	485.5	510.5	535.5	560.5
L2	112.5	137.5	162.5	187.5	212.5	237.5	262.5	287.5	312.5	325	350	375	400	425	450	475	500	525	550
L3	96	120	144	168	192	216	240	264	288	312	336	360	384	408	432	456	480	504	528
L4	13.5	14	14.5	15	15.5	16	16.5	17	17.5	12	12.5	13	13.5	14	14.5	15	15.5	16	16.5
L5	66	90	114	138	162	186	210	234	258	282	306	330	354	378	402	426	450	474	498

Note) For direct mounting without DIN rail, total width of manifold is L3.

Directional Control Valves
Air Cylinders
Rotary Actuators
Air Grippers
Air Preparation Equipment
Modular F. R.
Pressure Control Equipment
Fittings & Tubing
Flow Control Equipment
Pressure Switches/Pressure Sensors

Type 20P Series 10-SY3000/5000/7000

5 Port Solenoid Valve
Body Ported Manifold
Bar Stock Type/Flat Ribbon Cable

Note) CE-compliant:
For DC only.



How to Order Manifold

10 - SS5Y 5 - 20P - 05 - [] - []

Clean series

Manifold series

3	10-SY3000
5	10-SY5000
7	10-SY7000

Stations

03	3 stations
:	?
12	12 stations

Note) SS5Y3 has 4 to 12 stations.

Thread type

Nil	Rc
00F	G
00N	NPT
00T	NPTF

CE-compliant

Nil	—
Q	CE-compliant

Note) CE-compliant: For DC only.

How to Order Manifold Assembly (Example)

Example

Example

Cylinder port size
C6: With ø6 One-touch fitting
(Single solenoid) Connector assembly
10-SY3000-37-3A
(Double solenoid) Connector assembly
10-SY3000-37-4A

Double solenoid (24 VDC)
10-SY3220-5LOU-C6 (2 sets)

Single solenoid (24 VDC)
10-SY3120-5LOU-C6 (3 sets)

Blanking plate assembly
SY3000-26-10A (1 set)

Manifold base (6 stations)
10-SS5Y3-20P-06

Stations 3 2 1

10-SS5Y3-20P-061 set (Type 20P, 6-station manifold part no.)
 * SY3000-26-10A1 set (Blanking plate assembly part no.)
 * 10-SY3120-5LOU-C6 ...3 sets (Single solenoid part no.)
 * 10-SY3220-5LOU-C6 ...2 sets (Double solenoid part no.)
 * SY3000-37-3A3 sets (Connector assembly part no.)
 * SY3000-37-4A2 sets (Connector assembly part no.)

The asterisk denotes the symbol for assembly.
Prefix it to the part no. of the solenoid valve, etc.

Add the valve and option part number under the manifold base part number.
For complex arrangements, specify them on the manifold specification sheet.

Note) Please indicate the connector assembly part no. below that connects the valve and the manifold.

Connector Assembly

For 12, 24 VDC

Specifications	For 10-SY3000	For 10-SY5000/7000
For single solenoid	SY3000-37-3A	SY5000-37-3A
Double solenoid, 3 position type	SY3000-37-4A	SY5000-37-4A
Single with spacer assembly	SY5000-37-3A	SY5000-37-5A
Double, 3 position with spacer assembly	SY3000-37-6A	SY5000-37-6A

Note) Spacer assembly indicates individual SUP/EXH.

For 100 VAC

Specifications	For 10-SY3000	For 10-SY5000/7000
For single solenoid	SY3000-37-32A	SY5000-37-15A
Double solenoid, 3 position type	SY3000-37-33A	SY5000-37-16A
Single with spacer assembly	SY5000-37-15A	SY5000-37-17A
Double, 3 position with spacer assembly	SY3000-37-34A	SY5000-37-18A

For 110 VAC (115 VAC)

Specifications	For 10-SY3000	For 10-SY5000/7000
For single solenoid	SY3000-37-35A	SY5000-37-19A
Double solenoid, 3 position type	SY3000-37-36A	SY5000-37-20A
Single with spacer assembly	SY5000-37-19A	SY5000-37-21A
Double, 3 position with spacer assembly	SY3000-37-37A	SY5000-37-22A

⚠ Caution

- For non-polar "U" valves, the electrical DC connections can be used with either positive and negative COM. For type "Z", only use with positive COM as the valve does not operate correctly when used with negative COM.



How to Order Valve

Note) CE-compliant: For DC only. [Option]

Coil type

Nll	Standard
T	With power saving circuit

Rated voltage CE-compliant

5	24 VDC	●
6	12 VDC	●

Light/surge voltage suppressor

Z	With light/surge voltage suppressor
U	With light/surge voltage suppressor (Non-polar type)

Note) Z: Positive common specifications only.
 * Power saving circuit is only available for the "Z" type.

Note) For flat ribbon cables, "U" and "Z" types are for DC specifications and "Z" type is for AC specifications. "Z" for DC is positive common specifications only. For other combinations, please contact SMC.

For DC: 10-SY 5 1 20 - 5 LO Z - 01 -

For AC: 10-SY 5 1 20 - 1 LO Z - 01 -

Clean series ●

Series

3	10-SY3000
5	10-SY5000
7	10-SY7000

Actuation type

1	2 position single
2	2 position double
3	3 position closed center
4	3 position exhaust center
5	3 position pressure center

Rated voltage CE-compliant

1	100 VAC	—
3	110 VAC (115 VAC)	—

Note) CE-compliant: For DC only.

Manual override

Nll	Non-locking push type
D	Push-turn locking slotted type
E	Push-turn locking lever type

A, B port size

Thread piping

Symbol	Port size	Applicable series
M5	M5 x 0.8	10-SY3000
01	1/8	10-SY5000
02	1/4	10-SY7000

One-touch fitting (Metric size)

Symbol	Port size	Applicable series
C4	ø4 One-touch fitting	10-SY3000
C6	ø6 One-touch fitting	10-SY5000
C8	ø8 One-touch fitting	10-SY5000
C10	ø10 One-touch fitting	10-SY7000

One-touch fitting (Inch size)

Symbol	Port size	Applicable series
N3	ø3/8" One-touch fitting	10-SY3000
N7	ø1/4" One-touch fitting	10-SY3000
N3	ø3/8" One-touch fitting	10-SY5000
N7	ø1/4" One-touch fitting	10-SY5000
N9	ø3/16" One-touch fitting	10-SY7000
N9	ø3/16" One-touch fitting	10-SY7000
N11	ø3/8" One-touch fitting	10-SY7000

Thread type

Nll	Rc
F	G
N	NPT
T	NPTF

* Except for M5

Note) When placing an order for body ported solenoid valves as a single unit, the mounting screws for the manifold and gasket are not attached. Order them separately, if necessary.
 Note) Since the electrical entry is "LO", select a connector assembly part no. from those stated on page 83.

■ Gasket assembly part no.

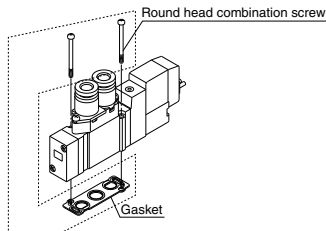

Series	Gasket assembly part no.
10-SY3000	SY3000-GS-1
10-SY5000	SY5000-GS-1
10-SY7000	SY7000-GS-1

Note) The gasket assembly consists of 10 sets of mounting screws and a gasket.

Directional Control Valves

Air Cylinders

Rotary Actuators

Air Grippers

Air Preparation Equipment

Modular F. R.

Pressure Control Equipment

Fittings & Tubing

Flow Control Equipment

Pressure Switches/ Pressure Sensors

- Multiple valve wiring is simplified through the use of the flat ribbon cable connector
- Clean appearance

For flat ribbon cables, each valve is wired on the print board of the manifold base to allow the external wiring to be piped all together with the 26 pin MIL connector.

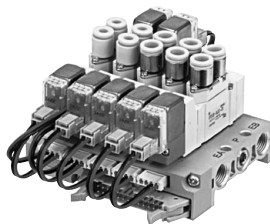

Manifold Specifications

Model	10-SSY3-20P(-Q)	10-SSY5-20P(-Q)	10-SSY7-20P(-Q)	
Applicable valve	10-SY3□20	10-SY5□20	10-SY7□20	
Manifold type	Single base/B mount			
P (SUP/R (EXH))	Common SUP, Common EXH			
Valve stations	4 to 12 stations ^{Note 1)}	3 to 12 stations ^{Note 1)}		
A, B port location	Valve			
Port size	P, EA, EB port	1/8	1/4	1/4
	A, B port	M5 x 0.8 C4 (ø4 One-touch fitting) C6 (ø6 One-touch fitting)	1/8 C4 (ø4 One-touch fitting) C6 (ø6 One-touch fitting) C8 (ø8 One-touch fitting)	1/4 C8 (ø8 One-touch fitting) C10 (ø10 One-touch fitting)
Manifold base weight W (g)	W = 19n + 45	W = 43n + 77	W = 51n + 81	
n: Stations				
Applicable flat ribbon cable connector	Flat ribbon cable connector, Socket: 26 pin MIL type with strain relief, Conforming to MIL-C-83503			
Internal wiring	Common between +COM and -COM (Z type: +COM only).			
Rated voltage ^{Note 4)}	12, 24 VDC 100, 110 VAC			

Note 1) For more than 10 stations (more than 5 stations in case of 10-SSY7), supply pressure to P port on both sides and exhaust from EA/EB port on both sides.

Note 2) The withstand voltage specification for the wiring unit section is JIS C 0704, Grade 1 or its equivalent.

Note 3) Refer to "Manifold Option" on page 100.

Note 4) CE-compliant: For DC only.

Flow Rate Characteristics

Model	Port size		Flow rate characteristics					
	1, 5, 3 (P, EA, EB)	4, 2 (A, B)	1 → 4/2 (P → A/B)			4/2 → 5/3 (A/B → EA/EB)		
			C [dm ³ /(s·bar)]	b	Cv	C [dm ³ /(s·bar)]	b	Cv
10-SSY3-20P	1/8	C6	0.72	0.29	0.18	0.80	0.36	0.21
10-SSY5-20P	1/4	C8	1.9	0.28	0.48	2.2	0.20	0.53
10-SSY7-20P	1/4	C10	3.6	0.31	0.93	3.6	0.27	0.88

Note) The values are for individually operated 2 position type manifold bases with 5 stations.

Internal Wiring of Manifold

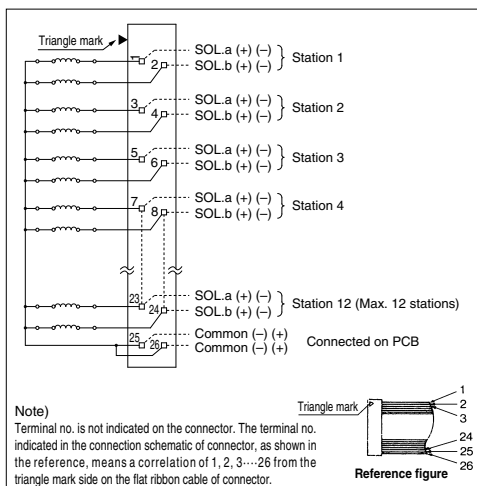

Caution

- For non-polar "U" valves, the electrical DC connections can be used with either positive and negative COM. For type "Z", only use with positive COM as the valve does not operate correctly when used with negative COM.

- For more than 10 stations, both poles of the common should be wired.
- For single solenoid, connect to the solenoid A side.
- The maximum number of stations that can be accommodated is 12. For more stations, please contact SMC.

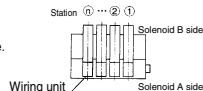

10-SY3000: 10-SS5Y3-20P- Stations

[] : AC

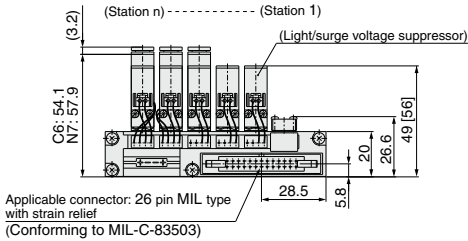
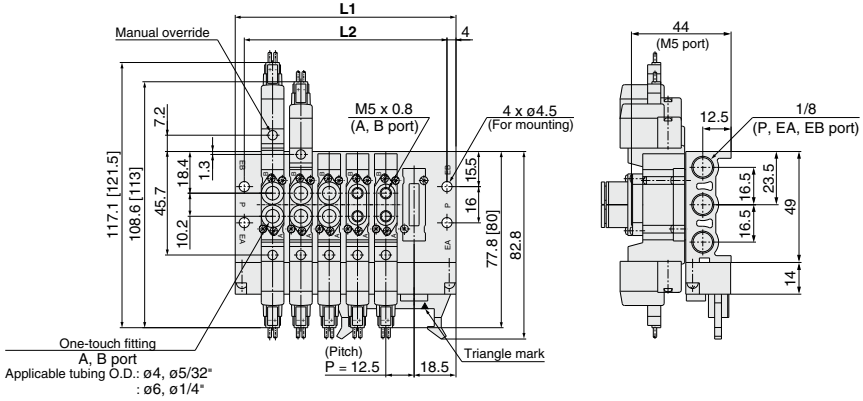

Stations	4	5	6	7	8	9	10	11	12
L1	72.5	85	97.5	110	122.5	135	147.5	160	172.5
L2	64.5	77	89.5	102	114.5	127	139.5	152	164.5

Directional Control Valves

Air Cylinders

Rotary Actuators

Air Grippers

Air Preparation Equipment

Modular F. R.

Pressure Control Equipment

Fittings & Tubing

Flow Control Equipment

Pressure Switches/ Pressure Sensors

10-SY5000: 10-SS5Y5-20P- Stations

[]: AC

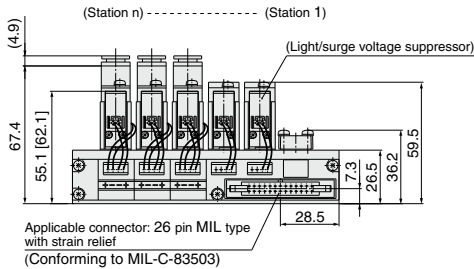
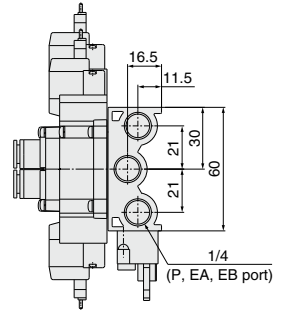
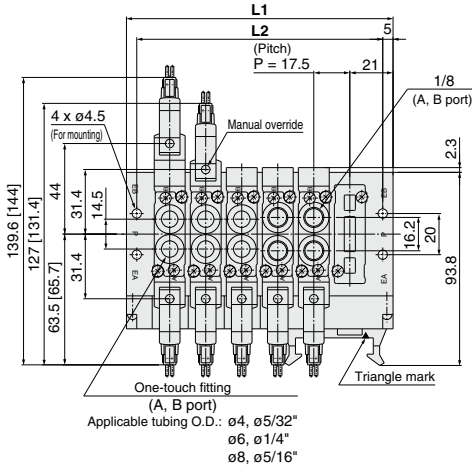

Stations	3	4	5	6	7	8	9	10	11	12
L1	77	94.5	112	129.5	147	164.5	182	199.5	217	234.5
L2	67	84.5	102	119.5	137	154.5	172	189.5	207	224.5

10-SY7000: 10-SS5Y7-20P- Stations

[] : AC

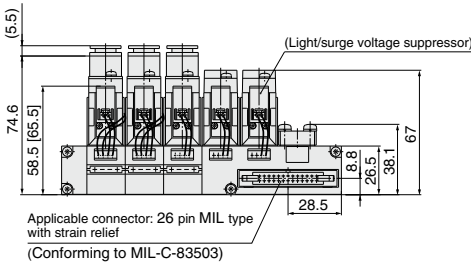
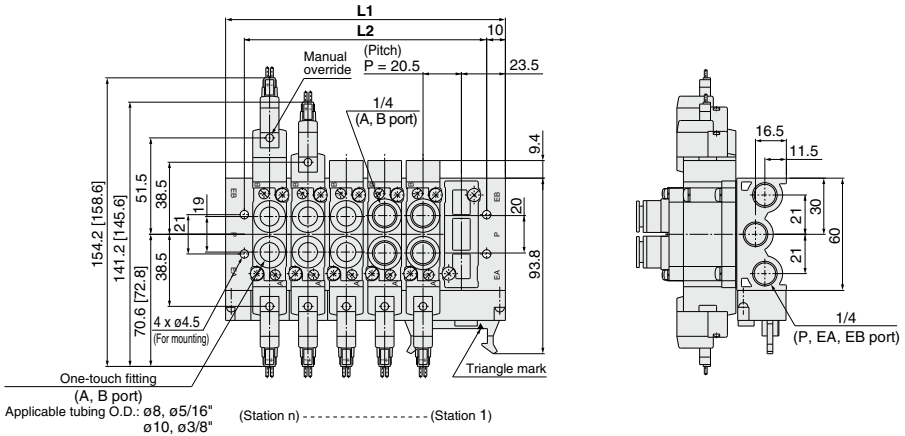

Stations	3	4	5	6	7	8	9	10	11	12
L1	88	108.5	129	149.5	170	190.5	211	231.5	252	272.5
L2	68	88.5	109	129.5	150	170.5	191	211.5	232	252.5

- Directional Control Valves
- Air Cylinders
- Rotary Actuators
- Air Grippers
- Air Preparation Equipment
- Modular F. R.
- Pressure Control Equipment
- Fittings & Tubing
- Flow Control Equipment
- Pressure Switches/ Pressure Sensors

Type 23P Series 10-SY9000

5 Port Solenoid Valve
Body Ported Manifold
Stacking Type/Flat Ribbon Cable



Note) CE-compliant:
For DC only. [Option]

How to Order Manifold

Type 23P/Common external pilot



Valve stations

Symbol	Stations
04	4 stations
:	:
12	12 stations

Thread type

Nil	Rc
00F	G
00N	NPT
00T	NPTF

* Includes the number of blanking plate assemblies.

Option

Symbol	Mounting
Nil	Direct mounting
D	DIN rail mounting (with DIN rail)
DO	DIN rail mounting (without DIN rail)
D*	When a longer DIN rail is desired than the specified stations, specify the station number to be required in place of the * mark.

CE-compliant

Nil	—
Q	CE-compliant

* Type 23P manifold of the 10-SY9000 series is concurrently used for the internal and external pilot.

Note) CE-compliant: For DC only.

How to Order Manifold Assembly (Example)

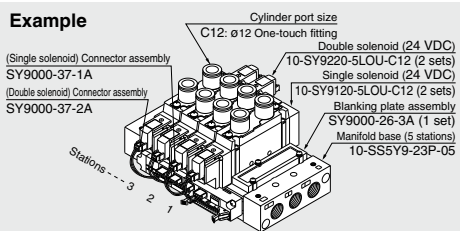

- 10-SS5Y9-23P-05 1 set (Type 23, 5-station manifold base part no.)
- SY9000-26-3A 1 set (Blanking plate assembly part no.)
- 10-SY9120-5LOU-C12... 2 sets (Single solenoid part no.)
- 10-SY9220-5LOU-C12... 2 sets (Double solenoid part no.)
- SY9000-37-1A 2 sets (Connector assembly part no.)
- SY9000-37-2A 2 sets (Connector assembly part no.)

The asterisk denotes the symbol for assembly. Prefix it to the part no. of the solenoid valve, etc.

Add the valve and option part number under the manifold base part number. For complex arrangements, specify them on the manifold specification sheet.

Note) Please indicate the connector assembly part no. (page 90) that connects the valve and the manifold.

How to Order Valve

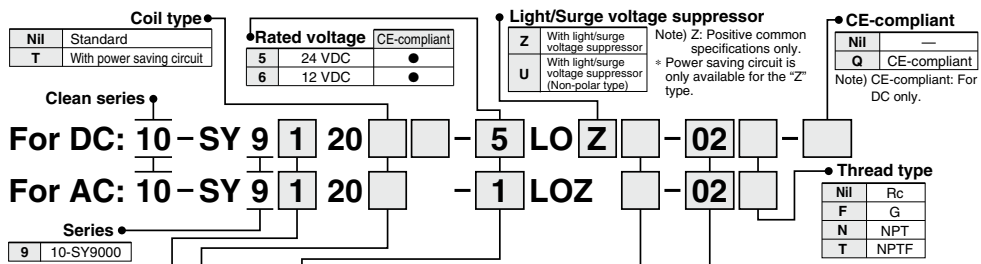

Actuation type

1	2 position single
2	2 position double
3	3 position closed center
4	3 position exhaust center
5	3 position pressure center

Pilot type

Nil	Internal pilot
R	External pilot

* Type 23P manifolds can be used for both internal and external pilots.

Rated voltage

1	100 VAC	—
3	110 VAC (115 VAC)	—

Note) CE-compliant: For DC only.

Manual override

Nil	Non-locking push type
D	Push-turn locking slotted type
E	Push-turn locking lever type

A, B port size

Thread piping

Symbol	Port size
02	1/4
03	3/8

One-touch fitting (Metric size)

Symbol	Port size
C8	ø8 One-touch fitting
C10	ø10 One-touch fitting
C12	ø12 One-touch fitting

One-touch fitting (Inch size)

Symbol	Port size
N9	ø 5/16" One-touch fitting
N11	ø 3/8" One-touch fitting

Note) For flat ribbon cables, "U" and "Z" types are for DC specifications and "Z" type is for AC specifications. "Z" type for DC is positive common specification only. For other combinations, please contact SMC.

Note) When placing an order for body ported solenoid valves as a single unit, the mounting screws for the manifold and gasket are not attached. Order them separately, if necessary.

Note) Since the electrical entry is "LO", select a connector assembly part no. from those stated on page 90.

Gasket assembly part no.

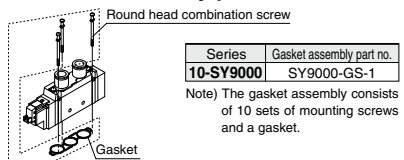

Manifold Specifications

- Multiple valve wiring is simplified through the use of the flat ribbon cable connector.
- Clean appearance

For flat ribbon cables, each valve is wired on the print board of the manifold base to allow the external wiring to be piped all together with the 26 pin MIL connector.

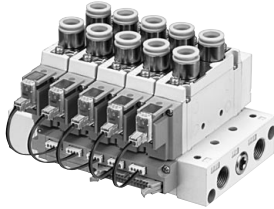

Model	10-SS5Y9-23P(-Q)	
Applicable valve	10-SY9□20	
Manifold type	Stacking type	
P (SUP)/R (EXH)	Common SUP, Common EXH	
Valve stations	4 to 12 stations ^{Note 1)}	
A, B port location	Valve	
Port size	P, EA, EB port	3/8
	A, B port	1/4
		3/8
		C8 (ø8 One-touch fitting) C10 (ø10 One-touch fitting) C12 (ø12 One-touch fitting)
Manifold base weight W (g)	W = 73n + 259	
n: Stations		
Applicable flat ribbon cable connector	Flat ribbon cable connector, Socket: 26 pin MIL with strain relief, Conforming to MIL-C-83503	
Internal wiring	Common +COM and -COM (Z type: +COM only)	
Rated voltage ^{Note 4)}	12, 24 VDC, 100, 110 VAC	

Note 1) For more than 10 stations, supply pressure to P port on both sides and exhaust from EA/EB port on both sides.
 Note 2) The withstand voltage specification for the wiring unit section is JIS C 0704, Grade 1 or its equivalent.
 Note 3) Refer to "Manifold Option" on page 100.
 Note 4) CE-compliant: For DC only.

Connector Assembly

For 12, 24 VDC

Specifications	For 10-SY9000
For single solenoid	SY9000-37-1A
Double solenoid 3 position	SY9000-37-2A
Single with spacer assembly	SY9000-37-3A
Double, 3 position with spacer assembly	SY9000-37-4A

For 100 VAC

Specifications	For 10-SY9000
For single solenoid	SY9000-37-1B
Double solenoid 3 position	SY9000-37-2B
Single with spacer assembly	SY9000-37-3B
Double, 3 position with spacer assembly	SY9000-37-4B

For 110 VAC (115 VAC)

Specifications	For 10-SY9000
For single solenoid	SY9000-37-1C
Double solenoid 3 position	SY9000-37-2C
Single with spacer assembly	SY9000-37-3C
Double, 3 position with spacer assembly	SY9000-37-4C

Note) Spacer assembly indicates individual SUP/EXH.

Flow Rate Characteristics

Model	Port size		Flow rate characteristics					
	1, 5, 3 (P, EA, EB)	4, 2 (A, B)	1 → 4/2 (P → A/B)		4/2 → 5/3 (A/B → EA/EB)			
			C (dm ³ /s/bar)	b	Cv	C (dm ³ /s/bar)	b	Cv
10-SS5Y9-23P(-Q)	3/8	C12	6.3	0.20	1.5	8.2	0.28	1.9

Note) The values are for individually operated 2 position type manifold bases with 5 stations.

Internal Wiring of Manifold

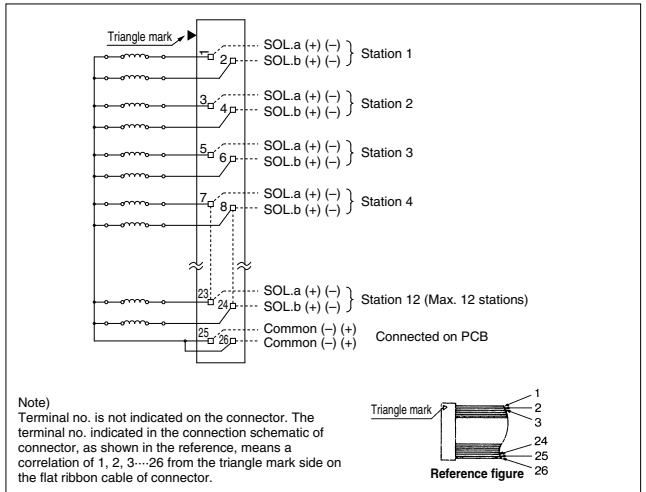

Note) Terminal no. is not indicated on the connector. The terminal no. indicated in the connection schematic of connector, as shown in the reference, means a correlation of 1, 2, 3...26 from the triangle mark side on the flat ribbon cable of connector.

- For more than 10 stations, both poles of the common should be wired.
- For single solenoid, connect to the solenoid A side.
- The maximum number of stations that can be accommodated is 12. For more stations, please contact SMC.

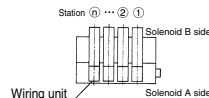

Caution

- For non-polar "U" valves, the electrical DC connections can be used with either positive and negative COM. For type "Z", only use with positive COM as the valve does not operate correctly when used with negative COM.

Directional Control Valves
 Air Cylinders
 Rotary Actuators
 Air Grippers
 Air Preparation Equipment
 Modular F. R.
 Pressure Control Equipment
 Fittings & Tubing
 Flow Control Equipment
 Pressure Switches/ Pressure Sensors

10-SY9000: 10-SS5Y9-23P- Stations -(D)

[] : AC

Grommet (G)

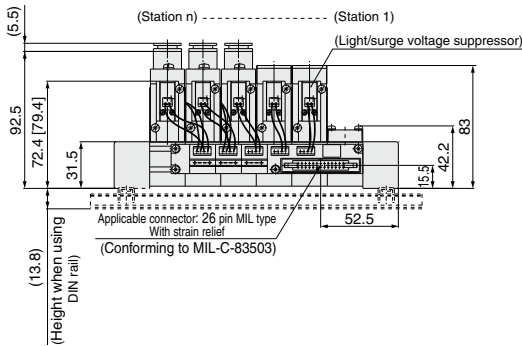
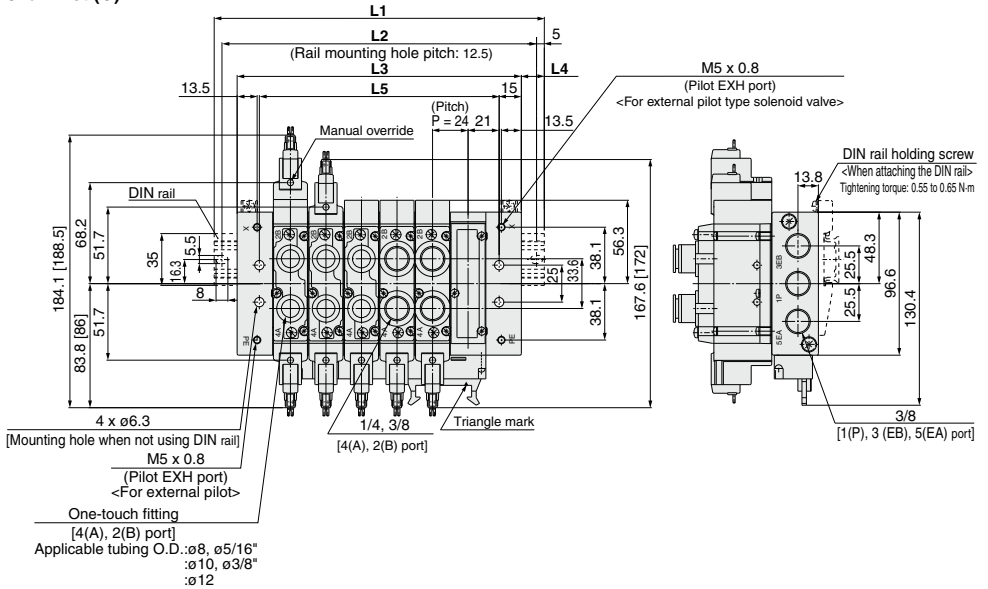

Stations	4 stations	5	6	7	8	9	10	11	12 stations
L1	173	198	223	248	273	298	323	335.5	360.5
L2	162.5	187.5	212.5	237.5	262.5	287.5	312.5	325	350
L3	144	168	192	216	240	264	288	312	336
L4	14.5	15	15.5	16	16.5	17	17.5	12	12.5
L5	114	138	162	186	210	234	258	282	306

Note) For direct mounting without DIN rail, total width of manifold is L3.

Type 20SA Series 10-SY3000/5000/7000

EX510 Gateway-type
Serial Transmission System
Body Ported Manifold/Integrated Base



Directional
Control Valves

Air Cylinders

Rotary Actuators

Air Grippers

Air Preparation
Equipment

Modular F. R.

Pressure Control
Equipment

Fittings & Tubing

Flow Control
Equipment

Pressure Switches/
Pressure Sensors

How to Order Manifold

10 - SS5Y 3 - 20SA [] - 04 - [] - []

• Clean series

Manifold series

3	10-SY3000
5	10-SY5000
7	10-SY7000

SI unit

NII	NPN output (+COM.)
N	PNP output (-COM.)

SI unit part no.

Symbol	SI unit specifications	SI unit part no.
NII	NPN output (+COM.)	EX510-S001
N	PNP output (-COM.)	EX510-S101

Refer to the **WEB catalog** and the Operation Manual for the details of the EX510 Gateway-type Serial Transmission System. Please download the Operation Manual via our website, <http://www.smcworld.com>

• CE-compliant

NII	—
Q	CE-compliant

• P, R port thread type

NII	Rc
00F	G
00N	NPT
00T	NPTF

• Valve stations

Symbol	Stations	Note
03	3 stations	Double wiring ^{Note 1)}
:	:	
08	8 stations	Specified layout ^{Note 2)} (Compatible with 16 solenoid valves)
03	3 stations	
:	:	
16	16 stations	

- 10-SS5Y3 can be set from 4 stations.
- The number of the blanking plate assembly is also included.
- Note 1) Double wiring: Use of a single solenoid will result in an unused control signal. If this is not desired, order with a specified layout.
- Note 2) Specified layout: Indicate wiring specifications on the manifold specification sheet. (Note that double and 3 position valves cannot be used where single solenoid wiring has been specified.)

How to Order Manifold Assembly (Example)

Example

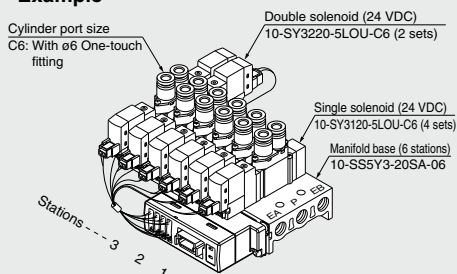

10-SS5Y3-20SA-06 1 set (20SA type 6-station manifold part no.)
 * 10-SY3120-5LOU-C6 ... 4 sets (Single solenoid part no.)
 * 10-SY3220-5LOU-C6 ... 2 sets (Double solenoid part no.)

The asterisk denotes the symbol for assembly. Prefix to the part no. of the solenoid valve, etc.

Add the valve and option part number under the manifold base part number.
 When entry of part numbers becomes complicated, indicate by the manifold specification sheet. For a EX510 manifold, the length of the lead wire for a connector assembly depends on the number of stations. Therefore, the manifold assembly is shipped with the valves (including blanking plates) and connector assembly mounted on it, as the standard specification. Be sure to specify the part no. of the solenoid valves to be mounted.

How to Order Valve

10-SY3120-5LOZ-M5

- Clean series**
- Series**

3	10-SY3000
5	10-SY5000
7	10-SY7000
- Actuation type**

1	2 position single
2	2 position double
3	3 position closed center
4	3 position exhaust center
5	3 position pressure center
- Coil type**

Nil	Standard
T	With power saving circuit
- Rated voltage: 24 VDC**
- Light/Surge voltage suppressor**

Z	With light/surge voltage suppressor
U	With light/surge voltage suppressor (Non-polar type)

Note 1) Power saving circuit is only available for the "Z" type.
Note 2) When the SI unit is the PNP output (-COM.), only the "U" type is available.
- Manual override**

Nil	Non-locking push type
D	Push-turn locking slotted type
E	Push-turn locking lever type
- CE-compliant**

Nil	—
Q	CE-compliant
- Thread type**

Nil	Rc
F	G
N	NPT
T	NPTF
- A, B port size**
- Thread piping**

M5	M5 x 0.8	10-SY3000
01	1/8	10-SY5000
02	1/4	10-SY7000
- One-touch fitting (Metric size)**

C4	ø4 One-touch fitting	10-SY3000
C6	ø6 One-touch fitting	10-SY3000
C4	ø4 One-touch fitting	10-SY5000
C6	ø6 One-touch fitting	10-SY5000
C8	ø8 One-touch fitting	10-SY7000
C8	ø8 One-touch fitting	10-SY7000
C10	ø10 One-touch fitting	10-SY7000
- One-touch fitting (Inch size)**

N3	ø5/32" One-touch fitting	10-SY3000
N7	ø1/4" One-touch fitting	10-SY3000
N3	ø5/32" One-touch fitting	10-SY5000
N7	ø1/4" One-touch fitting	10-SY5000
N9	ø5/16" One-touch fitting	10-SY7000
N9	ø5/16" One-touch fitting	10-SY7000
N11	ø3/8" One-touch fitting	10-SY7000

Note) When placing an order for body ported solenoid valves as a single unit, the mounting screws for the manifold and gasket are not attached. Order them separately, if necessary.

■ Gasket assembly part no.

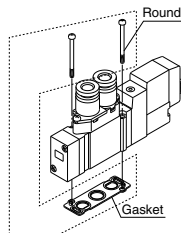

Series	Gasket assembly part no.
10-SY3000	SY3000-GS-1
10-SY5000	SY5000-GS-1
10-SY7000	SY7000-GS-1

Note) The gasket assembly consists of 10 sets of mounting screws and a gasket.

10-SY3000: 10-SS5Y3-20SA - Stations -

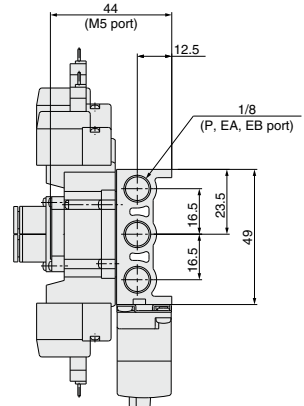
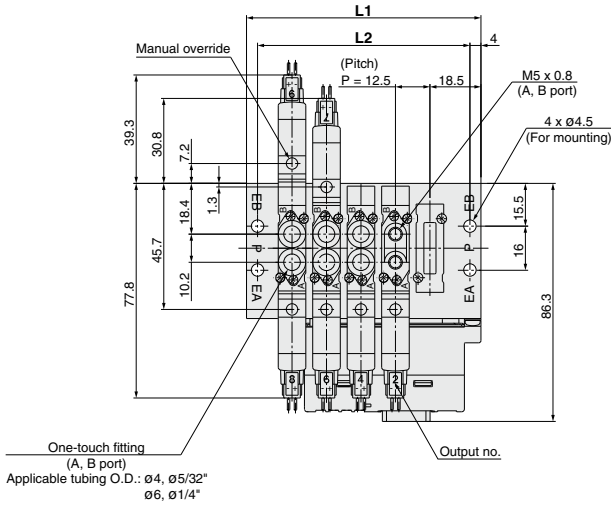

(Station n) ----- (Station 1)

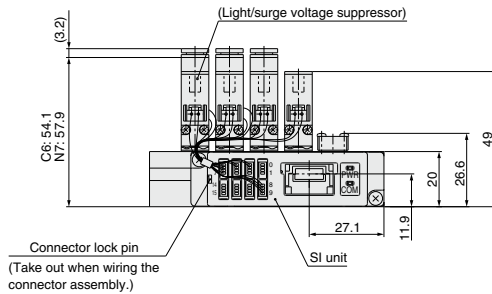

Stations	4 stations	5	6	7	8	9	10	11	12	13	14	15	16 stations
L1	72.5	85	97.5	110	122.5	135	147.5	160	172.5	185	197.5	210	222.5
L2	64.5	77	89.5	102	114.5	127	139.5	152	164.5	177	189.5	202	214.5

- Directional Control Valves
- Air Cylinders
- Rotary Actuators
- Air Grippers
- Air Preparation Equipment
- Modular F. R.
- Pressure Control Equipment
- Fittings & Tubing
- Flow Control Equipment
- Pressure Switches/ Pressure Sensors

10-SY5000: 10-SS5Y5-20SA - Stations -

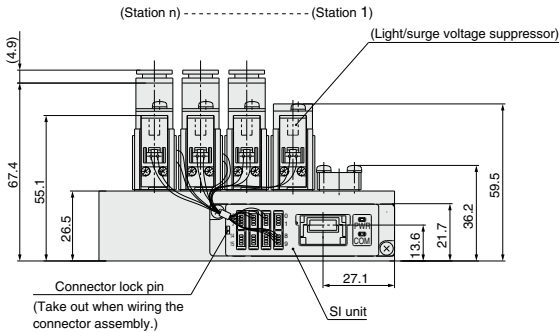
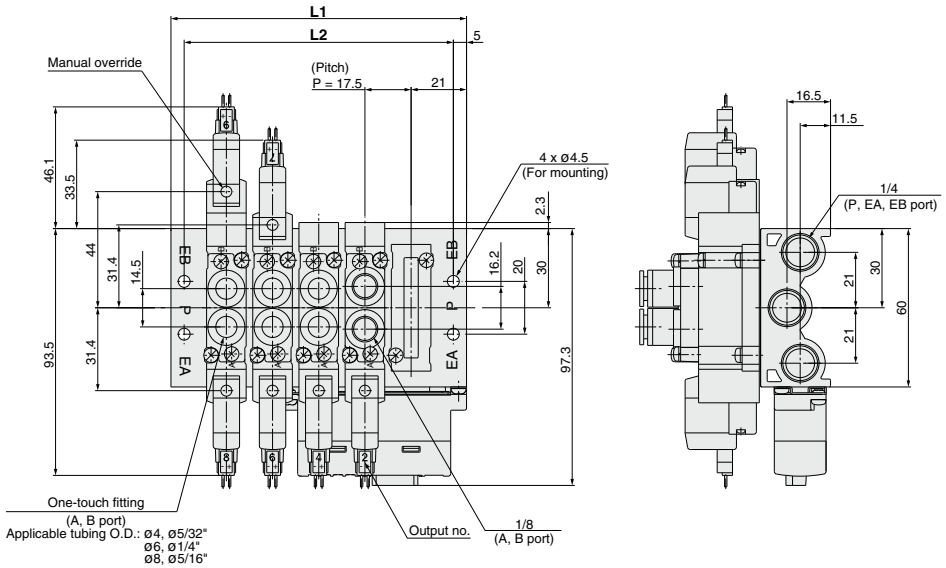

Stations	3 stations	4	5	6	7	8	9	10	11	12	13	14	15	16 stations
L1	77	94.5	112	129.5	147	164.5	182	199.5	217	234.5	252	269.5	287	304.5
L2	67	84.5	102	119.5	137	154.5	172	189.5	207	224.5	242	259.5	277	294.5

10-SY7000: 10-SS5Y7-20SA - Stations -

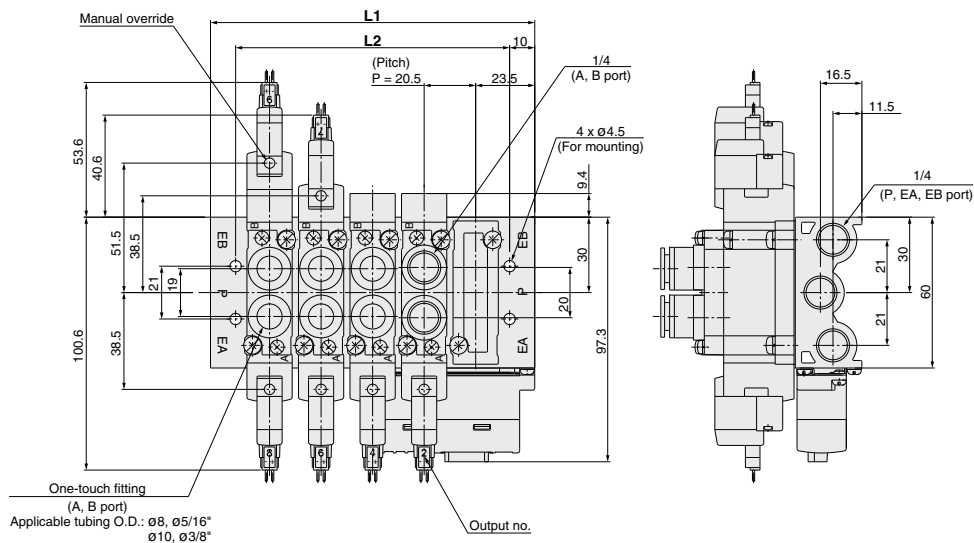

(Station n) ----- (Station 1)

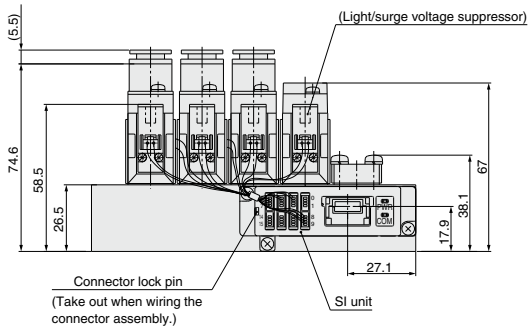

Stations	3 stations	4	5	6	7	8	9	10	11	12	13	14	15	16 stations
L1	88	108.5	129	149.5	170	190.5	211	231.5	252	272.5	293	313.5	334	354.5
L2	68	88.5	109	129.5	150	170.5	191	211.5	232	252.5	273	293.5	314	334.5

Directional Control Valves

Air Cylinders

Rotary Actuators

Air Grippers

Air Preparation Equipment

Modular F. R.

Pressure Control Equipment

Fittings & Tubing

Flow Control Equipment

Pressure Switches/ Pressure Sensors



How to Order Manifold

10-SS5Y9-23SA [] - 03 - [] - [] - []

• Clean series

SI unit*

NII	NPN output (+COM.)
N	PNP output (-COM.)

• CE-compliant

NII	—
Q	CE-compliant

Valve stations •

Symbol	Stations	Note
03	3 stations	Double wiring ^{Note 1)}
⋮	⋮	
08	8 stations	
03	3 stations	Specified layout ^{Note 2)} (Compatible with 16 solenoid valves)
⋮	⋮	
16	16 stations	

* The number of the blanking plate assembly is also included.

Note 1) Double wiring: Use of a single solenoid will result in an unused control signal. If this is not desired, order with a specified layout.

Note 2) Specified layout: Indicate wiring specifications on the manifold specification sheet. (Note that double and 3 position valves cannot be used where single solenoid wiring has been specified.)

• Option

NII	Direct mounting
D	DIN rail mounting (With DIN rail)
DO	DIN rail mounting (Without DIN rail)
D*	When a longer DIN rail is desired than the specified stations, specify the station number to be required in place of the * mark.

• P, R port thread type

NII	Rc
00F	G
00N	NPT
00T	NPTF

SI unit part no.

Symbol	SI unit specifications	SI unit part no.
NII	NPN output (+COM.)	EX510-S001
N	PNP output (-COM.)	EX510-S101

Refer to the **WEB catalog** and the Operation Manual for the details of the EX510 Gateway-type Serial Transmission System. Please download the Operation Manual via our website, <http://www.smworld.com>

How to Order Manifold Assembly (Example)

Example

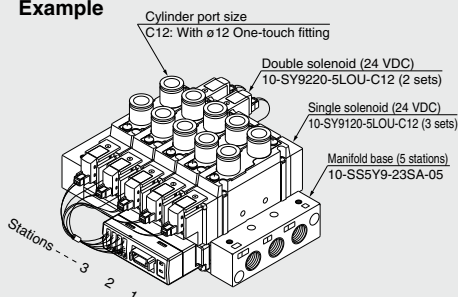

10-SS5Y9-23SA-05 1 set (23SA type 5-station manifold part no.)
 * 10-SY9120-5LOU-C12 ... 3 sets (Single solenoid part no.)
 * 10-SY9220-5LOU-C12 ... 2 sets (Double solenoid part no.)

— The asterisk denotes the symbol for assembly. Prefix to the part no. of the solenoid valve, etc.

Add the valve and option part number under the manifold base part number.

When entry of part numbers becomes complicated, indicate by the manifold specification sheet. For a EX510 manifold, the length of the lead wire for a connector assembly depends on the number of stations. Therefore, the manifold assembly is shipped with the valves (including blanking plates) and connector assembly mounted on it, as the standard specification. Be sure to specify the part no. of the solenoid valves to be mounted.

How to Order Valve

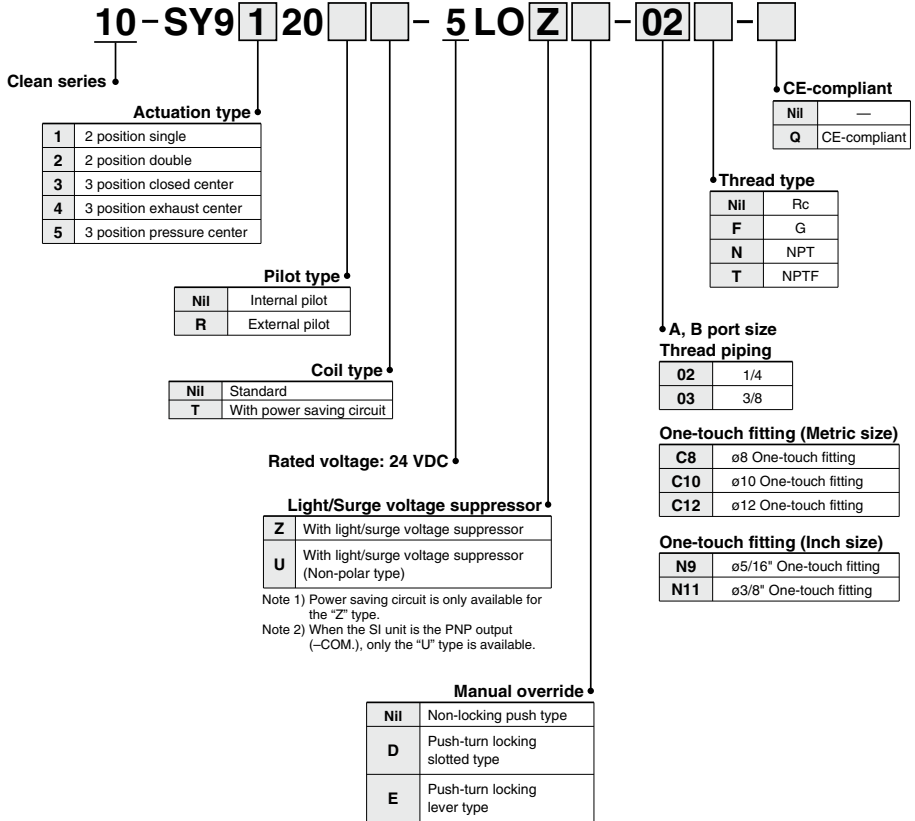

Directional Control Valves
Air Cylinders
Rotary Actuators
Air Grippers
Air Preparation Equipment
Modular F. R.
Pressure Control Equipment
Fittings & Tubing
Flow Control Equipment
Pressure Switches/ Pressure Sensors

Note) When placing an order for body ported solenoid valves as a single unit, the mounting screws for the manifold and gasket are not attached. Order them separately, if necessary.

Gasket assembly part no.

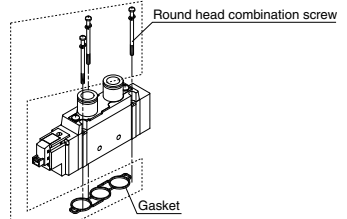

Series	Gasket assembly part no.
10-SY9000	SY9000-GS-1

Note) The gasket assembly consists of 10 sets of mounting screws and a gasket.

10-SY9000: 10-SS5Y9-23SA - Stations - (-D)

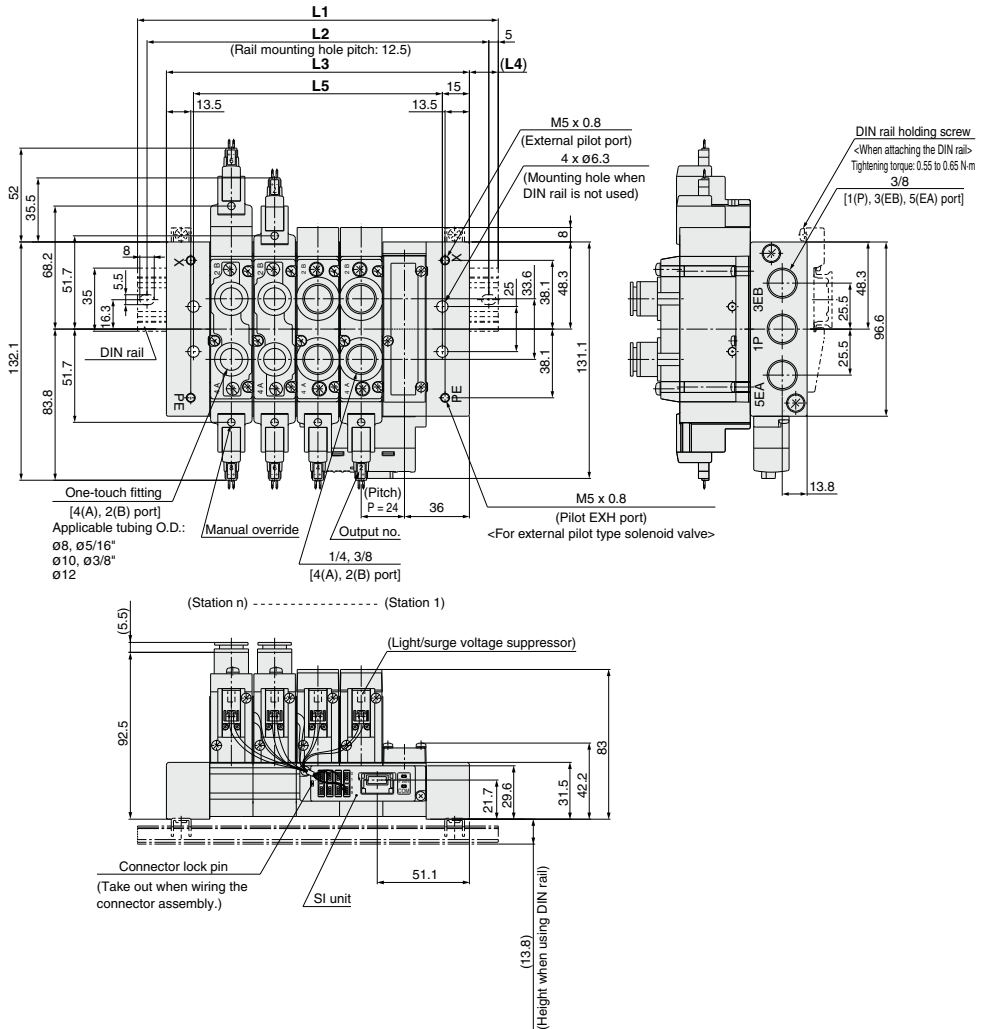

Stations	3 stations	4	5	6	7	8	9	10	11	12	13	14	15	16 stations
L1	148	173	198	223	248	273	298	323	335.5	360.5	385.5	410.5	435.5	460.5
L2	137.5	162.5	187.5	212.5	237.5	262.5	287.5	312.5	325	350	375	400	425	450
L3	120	144	168	192	216	240	264	288	312	336	360	384	408	432
L4	14	14.5	15	15.5	16	16.5	17	17.5	12	12.5	13	13.5	14	14.5
L5	90	114	138	162	186	210	234	258	282	306	330	354	378	402

Note) For direct mounting without DIN rail, total width of manifold is L3.

Manifold Option

■ Type 20, 23, 20SA, 23SA Blanking plate assembly

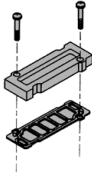

<Standard>

Series	Assembly part no.
10-SY3000	SY3000-26-9A
10-SY5000	SY5000-26-20A
10-SY7000	SY7000-26-22A
10-SY9000	SY9000-26-1A

<CE-compliant>

Series	Assembly part no.
10-SY3000	SY3000-26-19A-Q
10-SY5000	SY5000-26-1A-Q
10-SY7000	SY7000-26-1A-Q
10-SY9000	SY9000-26-1A-Q

■ Type 20P, 23P Blanking plate assembly

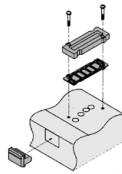

<Standard>

Series	Assembly part no.
10-SY3000	SY3000-26-10A
10-SY5000	SY5000-26-21A
10-SY7000	SY7000-26-23A
10-SY9000	SY9000-26-3A

<CE-compliant>

Series	Assembly part no.
10-SY3000	SY3000-26-20A-Q
10-SY5000	SY5000-26-3A-Q
10-SY7000	SY7000-26-3A-Q
10-SY9000	SY9000-26-3A-Q

■ Gasket assembly part no.

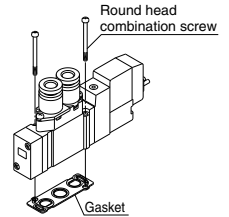

Series	Gasket assembly part no.
10-SY3000	SY3000-GS-1
10-SY5000	SY5000-GS-1
10-SY7000	SY7000-GS-1
10-SY9000	SY9000-GS-1

Note) The gasket assembly consists of 10 sets of mounting screws and a gasket.

■ Individual SUP spacer assembly

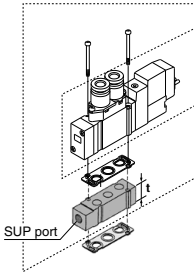

Series	Assembly part no.	Port size	t
10-SY3000	SY3000-38-20A(-Q)	M5 x 0.8	10.5
10-SY5000	SY5000-38-1+A(-Q)	1/8	15
10-SY7000	SY7000-38-1+A(-Q)	1/4	18
10-SY9000	SY9000-38-1+A(-Q)	1/4	20

Note) • The SUP port of 10-SY3000/5000/7000 may be either on the lead wire side or on the end plate side. However, as the CE-compliant products (-Q) must be mounted in the specified direction, the port directions cannot be changed. (An assembly is shipped under the conditions shown in the figure.)
• For the 10-SY9000, it can only be used on the end plate side.

■ Individual EXH spacer assembly

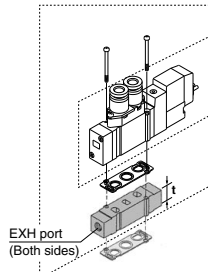

Series	Assembly part no.	Port size	t
10-SY3000	SY3000-39-20A(-Q)	M5 x 0.8	10.5
10-SY5000	SY5000-39-1+A(-Q)	1/8	15
10-SY7000	SY7000-39-1+A(-Q)	1/4	18
10-SY9000	SY9000-39-1+A(-Q)	1/4	20

Note) In case of 20P and 23P, for protection of the wiring unit section from drainage, piping at the EA port should be arranged so that it will not be directly exposed to exhaust from the valve.

■ Individual SUP spacer assembly + Individual EXH spacer assembly (Double spacer)

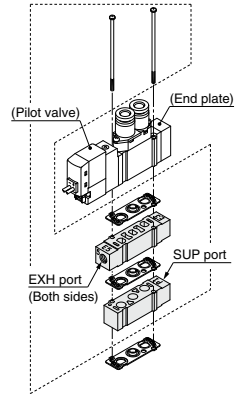

●: Available x: Not available

Series	Individual SUP + Individual EXH Assembly part no.	Port size	Applicable manifold types	
			20	20P
10-SY3000	SY3000-120-1A(-Q)	M5 x 0.8	●	x
10-SY5000	SY5000-75-2+A(-Q)	1/8	●	x
10-SY7000	SY7000-73-3+A(-Q)	1/4	●	x

Note) The SUP spacer's port does not have an orientation. However, as the CE-compliant products (-Q) must be mounted in the specified direction, the port directions cannot be changed. As for the EXH ports, adjust the symbol "S" to the pilot valve side. Also, please make sure to connect the individual ports to protect the wiring section of the pilot valve from drainage, etc.

The individual SUP spacer and EXH spacer can be mounted either on the upper side or lower side. (The above illustration shows the condition when the product is shipped out from a factory.)

⚠ Caution

Mounting screw tightening torques

M2: 0.16 N·m
M3: 0.8 N·m
M4: 1.4 N·m

* Thread type

Nil	Rc
F	G
N	NPT
T	NPTF

⚠ Warning

When mounting a valve or spacer on the manifold base or sub-plate, etc., those mounting directions are determined. If mounted in the wrong direction, the equipment to be connected may cause malfunction. Refer to external dimensions, and then mount it.

Manifold Option

■ Connector assembly

For single solenoid (SY3000-37-81A-□-N)

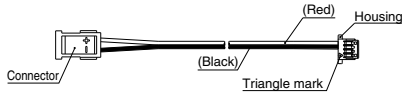

For double solenoid (SY3000-37-81A-□-□)

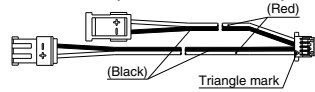

Connector assembly order no. (Can be used for the manifold without a specified layout (8 stations or less))
Integrated type

Model	Part no.	Connector mounting position
10-SS5Y3-20SA	SY3000-37-81A-3-N	Single : For 1 to 4 stations
	SY3000-37-81A-3-6	Double/3 position: For 1 to 4 stations
	SY3000-37-81A-2-N	Single : For 5 to 8 stations
	SY3000-37-81A-2-4	Double/3 position: For 5 to 8 stations
10-SS5Y5-20SA	SY3000-37-81A-3-N	Single : For 1 to 8 stations
	SY3000-37-81A-3-6	Double/3 position: For 1 to 8 stations
10-SS5Y7-20SA	SY3000-37-81A-3-N	Single : For 1 to 4 stations
	SY3000-37-81A-3-6	Double/3 position: For 1 to 4 stations
	SY3000-37-81A-4-N	Single : For 5 to 8 stations
	SY3000-37-81A-4-7	Double/3 position: For 5 to 8 stations

Note) The above is for station addition or maintenance. When ordering a connector assembly separately, the number is not printed on the connector.

■ Connector assembly

SY3000-37-80A-□

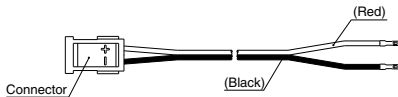

■ Housing (8 pcs/set)

SY3000-44-3A

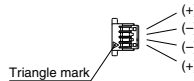

Connector assembly order no. (Can be used for the manifold with a specified layout)

Model	Part no.	Connector mounting position
10-SS5Y3-20SA	SY3000-37-80A-3	For A side
	SY3000-37-80A-6	For B side
	SY3000-37-80A-4	For A side
	SY3000-37-80A-7	For B side
10-SS5Y5-20SA	SY3000-37-80A-3	For A side
	SY3000-37-80A-6	For B side
	SY3000-37-80A-7	For A side
	SY3000-37-80A-9	For B side
10-SS5Y7-20SA	SY3000-37-80A-4	For A side
	SY3000-37-80A-7	For B side
	SY3000-37-80A-8	For A side
	SY3000-37-80A-11	For B side
10-SS5Y9-23SA	SY3000-37-80A-6	For A side
	SY3000-37-80A-11	For B side
	SY3000-37-80A-9	For A side
	SY3000-37-80A-14	For B side
	SY3000-37-80A-13	For A side
	SY3000-37-80A-18	For B side

Note 1) The above is for station addition or maintenance. When ordering a connector assembly separately, the number is not printed on the connector.

Note 2) After inserting the connector assembly into the housing, be sure to confirm that the lead wire will not come off by lightly pulling the wire. Furthermore, do not reuse the lead wire after it has been inserted and removed.

Note 3) Wiring is set longer than the actual wiring distance.

Manifold Option

■ SUP block disk (For 10-SY9000)

By installing a SUP block disk in the pressure supply passage of a manifold valve, it is possible to supply two or more different high and low pressures to one manifold.



Series	Part no.
10-SY9000	SY9000-61-2A

■ EXH block disk (For 10-SY9000)

By installing an EXH block disk in the exhaust passage of a manifold valve, it is possible to divide the valve's exhaust so that it does not affect another valve. (Two block disks are needed to divide both exhausts.)



Series	Part no.
10-SY9000	SY9000-61-2A

■ Label for block disk (For 10-SY9000)

The labels shown below are used on manifold stations containing SUP/EXH block disk(s) to show their location. (3 pcs. each)

VZ3000-123-1A

Label for SUP block disk



Label for EXH block disk



Label for SUP/EXH block disk



* When a block disk is concurrently ordered by specifying it on the manifold specification sheet, etc., a label will be attached to the position where the block disk is mounted.

■ DIN Rail Dimensions/Weight for 10-SY9000

VZ1000-11-4-□

■ Refer to L dimensions

* Fill in □ with an appropriate no. listed on the table of DIN rail dimensions shown below.

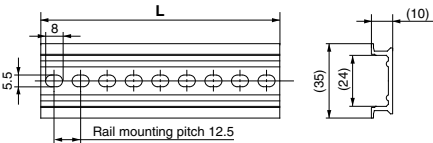

No.	0	1	2	3	4	5	6	7	8	9
L Dimension	98	110.5	123	135.5	148	160.5	173	185.5	198	210.5
Weight (g)	24.8	28	31.1	34.3	37.4	40.6	43.8	46.9	50.1	53.3
No.	10	11	12	13	14	15	16	17	18	19
L Dimension	223	235.5	248	260.5	273	285.5	298	310.5	323	335.5
Weight (g)	56.4	59.6	62.7	65.9	69.1	72.2	75.4	78.6	81.7	84.9
No.	20	21	22	23	24	25	26	27	28	29
L Dimension	348	360.5	373	385.5	398	410.5	423	435.5	448	460.5
Weight (g)	88	91.2	94.4	97.5	100.7	103.9	107	110.2	113.3	116.5

Note) For DIN rail, refer to page 175.

- Refer to L1 dimension on pages 82, 91 and 99 for lengths that correspond to the number of manifold stations.

■ Cable assembly (For 20P, 23P)

AXT100-FC26-1 to 3

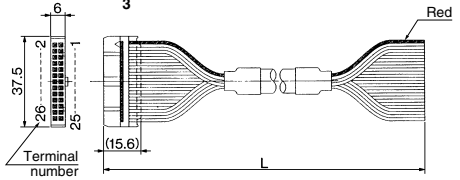

Connector Assembly for Flat Ribbon Cables

Cable length (L)	Assembly part no.	Note
1.5 m	AXT100-FC26-1	Cable 26 core x 28 AWG
3 m	AXT100-FC26-2	
5 m	AXT100-FC26-3	

* For other commercial connectors, use a 26 pin connector with strain relief conforming to MIL-C-83503.

Example of connector manufacturers

- HIROSE ELECTRIC CO., LTD.
- Japan Aviation Electronics Industry, Limited
- 3M Japan Limited
- J.S.T. Mfg. Co., Ltd.
- Fujitsu Limited

■ Plug

These are inserted in unused cylinder ports and SUP, EXH ports. Purchase orders are available in units of 10 pieces.

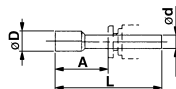

Dimensions

Applicable fittings size øD	Model	A	L	D
4	10-KQP-04	16	32	6
6	10-KQP-06	18	35	8
8	10-KQP-08	20.5	39	10
10	10-KQP-10	22	43	12
12	10-KQP-12	24	44.5	14
1/8"	10-KQP-01	16	31.5	5
5/32"	10-KQP-03	16	32	6
1/4"	10-KQP-07	18	35	8.5
5/16"	10-KQP-09	20.5	39	10
3/8"	10-KQP-11	22	43	11.5

How to Increase Manifold Bases (10-SY9000 series only) Manifold base can be added at any location.

When a type 23 manifold base is added, tension bolts as well as a manifold block assembly is required. Order the tension bolt for the stations after the stations are increased (decreased), since the length of a tension bolt depends on the number of stations. (When changing the number of stations for a type 23P manifold, a wiring unit for the stations and lead assembly will be required.)

- 1 Loosen the tension bolts ⑤ connecting the manifold base, and pull out both of the tension bolts.
(When equipped with a DIN rail, loosen one DIN rail holding screw on either U side or D side.)
- 2 Separate the blocks at the location where station expansion is desired.
- 3 Mount additional manifold block assembly.
- 4 Press block-to-block so that there is no gap. After connection, insert the tension bolts for the desired stations and then tighten them.

Caution (Tightening torque: 2.9 N·m)

(When equipped with a DIN rail, be sure to tighten the DIN rail holding screws after tightening the tension bolts. Tightening torque: 1.4 N·m)

Caution

1. Be sure to shut off the power and air supplies before disassembly. Furthermore, since air may remain inside the actuator, piping and manifold, confirm that the air is completely exhausted before performing any work.
2. When disassembly and assembly are performed, air leakage may result if connections between blocks and tightening of the end block's holding screw is inadequate.
3. By adding a wiring unit assembly to the type 23 manifold, it can be changed to the type 23P manifold.

Body Ported Manifold Exploded View, 23/23P Common

For the body ported manifold, disassembly and increases in the manifold are only possible with the 10-SY9000 series.

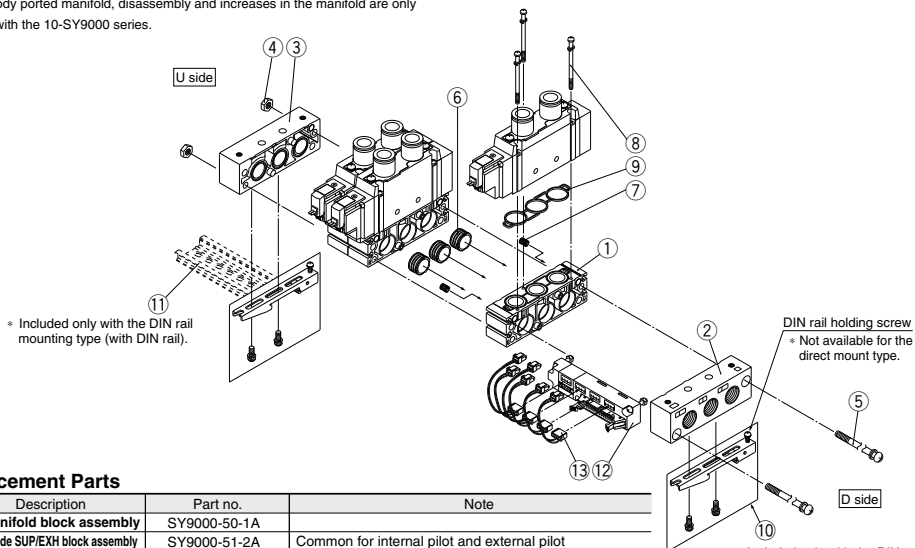

Replacement Parts

No.	Description	Part no.	Note
1	Manifold block assembly	SY9000-50-1A	
2	D side SUP/EXH block assembly	SY9000-51-2A	Common for internal pilot and external pilot
3	U side SUP/EXH block	SY9000-51-4	Common for internal pilot and external pilot
4	Hexagon nut	SY9000-25-1	M5 x 0.8
5	Tension bolt	SY9000-23-□	Since □ at the end of the part number corresponds with the number of stations, fill in the same number as the number of stations.
6	Bushing assembly	SY9000-61-1A	Included in the manifold block assembly and the D side SUP/EXH block assembly.
7	Bushing assembly	SY9000-61-3A	Included in the manifold block assembly and the D side SUP/EXH block assembly.
8	Round head combination screw	SY9000-18-2	Included in the manifold block assembly.
9	Manifold gasket	SY9000-11-1	Included in the manifold block assembly.
10	Clamp sub assembly	SY9000-29-1A	
11	DIN rail	VZ1000-11-4-□	Refer to page 102.
12	Wiring unit assembly	SY9000-36-□A	Since □ in the part number corresponds with the number of stations, fill in the number of stations (4 to 12).
13	Connector assembly	SY9000-37-□□	Refer to page 90.

Type 60 Series 10-SY3000/5000/7000

5 Port Solenoid Valve Body Ported Manifold Cassette Type



Note) AC-type models that are CE-compliant have DIN terminals only.

[Option]

An order cannot be placed with only the manifold part no. Be sure to order solenoid valves for mounting at the same time while referring to the ordering example.

How to Order

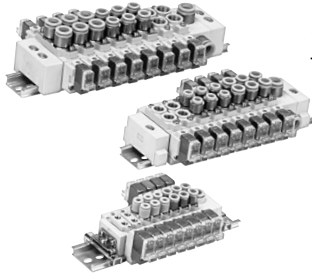

10-SS5Y 3-60-05 D - [] - []

• Clean series

Series

3	10-SY3000
5	10-SY5000
7	10-SY7000

Valve stations

02	2 stations
:	:
20	20 stations

• CE-compliant

Nil	—
Q	CE-compliant

Note) AC-type models that are CE-compliant have DIN terminals only.

• Option

When a longer DIN rail is desired than the specified stations, specify the station number to be required. (20 stations at maximum)

• SUP/EXH block assembly mounting position

Symbol	Mounting position	Applicable stations
U	U side	2 to 10 stations
D	D side	2 to 10 stations
B	Both sides	2 to 20 stations
M	Special specifications	

* For special specifications, indicate separately with the manifold specification sheet.

How to Order Manifold Assembly (Example)

Example

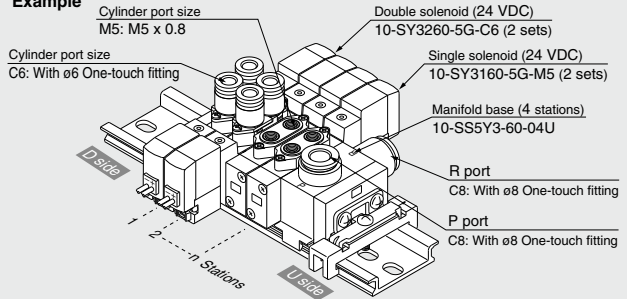

- 10-SS5Y3-60-04U 1 set (Type 60, 4-station manifold base part no.)
- * 10-SY3260-5G-C6 2 sets (Double solenoid part no.)
- * 10-SY3160-5G-M5 2 sets (Single solenoid part no.)

↳ The asterisk denotes the symbol for assembly. Prefix it to the part no. of the solenoid valve, etc.

Add the valve and option part number under the manifold base part number. For complex arrangements, specify them on the manifold specification sheet.

Directional Control Valves

Air Cylinders

Rotary Actuators

Air Grippers

Air Preparation Equipment

Modular F. R.

Pressure Control Equipment

Fittings & Tubing

Flow Control Equipment

Pressure Switches/ Pressure Sensors

Manifold Specifications

Model		10-SS5Y3-60(-Q)	10-SS5Y5-60(-Q)	10-SS5Y7-60(-Q)
Applicable valve		10-SY3□60	10-SY5□60	10-SY7□60
Manifold type		Stacking type/DIN rail mounted		
P (SUP)/R (EXH)		Common SUP/Common EXH		
Valve stations		2 to 20 stations ^{Note 1)}		
A, B port location		Valve		
Port size	P, R port	C8 (ø8 One-touch fitting) M5 x 0.8	C10 (ø10 One-touch fitting) 1/8	C12 (ø12 One-touch fitting) 1/4
	A, B port	C4 (ø4 One-touch fitting) C6 (ø6 One-touch fitting)	C4 (ø4 One-touch fitting) C6 (ø6 One-touch fitting) C8 (ø8 One-touch fitting)	C8 (ø8 One-touch fitting) C10 (ø10 One-touch fitting)
Manifold base weight W (g) (n: Number of SUP/EXH blocks, m: Weight of DIN rail)	^{Note 2)}	W = 13n + m + 36	W = 41.2n + m + 77.6	W = 65.4n + m + 128.2

Note 1) In cases such as those where many valves are operated simultaneously, use "-[Station]B (SUP/EXH block on both sides)", applying pressure to the P ports on both sides and exhausting from the R ports on both sides.

Note 2) For DIN rail weight, refer to page 110.

Flow Rate Characteristics

Model	Port size		Flow rate characteristics					
	1, 5/3 (P, R)	4, 2 (A, B)	1 → 4/2 (P → A/B)			4/2 → 5/3 (A/B → R)		
			C (dm ³ /(s·bar))	b	Cv	C (dm ³ /(s·bar))	b	Cv
10-SS5Y3-60(-Q)	C8	M5	0.55	0.29	0.14	0.72	0.24	0.18
		C4	0.57	0.24	0.14	0.71	0.20	0.17
		C6	0.68	0.28	0.17	0.77	0.24	0.19
10-SS5Y5-60(-Q)	C10	1/8	1.8	0.24	0.44	2.1	0.17	0.47
		C6	1.5	0.30	0.37	2.0	0.16	0.46
		C8	1.8	0.20	0.45	2.2	0.17	0.50
10-SS5Y7-60(-Q)	C12	1/4	3.7	0.25	0.96	3.8	0.19	0.94
		C8	3.2	0.26	0.81	4.0	0.18	0.96
		C10	3.7	0.28	0.98	4.1	0.19	1.0

Note) The values are for individually operated 2 position type manifold bases with 5 stations.



How to Order Valve

Note) AC-type models that are CE-compliant have DIN terminals only.

[Option]

10-SY 3 1 60

• Clean series

Series

3	10-SY3000
5	10-SY5000
7	10-SY7000

Actuation type

1	2 position single (A)4 2(B) (EA)5 1 3(EB) (P)
2	2 position double (A)4 2(B) (EA)5 1 3(EB) (P)
3	3 position closed center (A)4 2(B) (EA)5 1 3(EB) (P)
4	3 position exhaust center (A)4 2(B) (EA)5 1 3(EB) (P)
5	3 position pressure center (A)4 2(B) (EA)5 1 3(EB) (P)

Coil type

Nil	Standard
T	With power saving circuit (24 VDC, 12 VDC only)

* Power saving circuit is not available for D, Y, DO, YO or W□ types.

Rated voltage

5	24 VDC
6	12 VDC
V	6 VDC
S	5 VDC
R	3 VDC

For AC (50/60 Hz)

1	100 VAC
2	200 VAC
3	110 VAC (115 VAC)
4	220 VAC (230 VAC)

* DC specifications of type D, Y, DO and YO are only available with 12 and 24 VDC.
* Only D, Y, DO and YO are available for 10-SY5000, SY7000.

* For type W□, only DC voltage is available.
Note) AC-type models that are CE-compliant have DIN terminals only.

Manifold mounting	10-SY3000	●
	10-SY5000	●
	10-SY7000	●
CE-compliant	DC	●
	AC	—

A, B port size

Thread piping

Symbol	Port size	Applicable series
M5	M5 x 0.8	10-SY3000
O1	1/8	10-SY5000
O2	1/4	10-SY7000

One-touch fitting (Metric size)

Symbol	Port size	Applicable series
C4	ø4 One-touch fitting	10-SY3000
C6	ø6 One-touch fitting	10-SY3000
C4	ø4 One-touch fitting	10-SY5000
C6	ø6 One-touch fitting	10-SY5000
C8	ø8 One-touch fitting	10-SY5000
C8	ø8 One-touch fitting	10-SY5000
C10	ø10 One-touch fitting	10-SY7000

Thread type

Nil	Rc
F	G
N	NPT
T	NPTF

* Except for M5

One-touch fitting (Inch size)

Symbol	Port size	Applicable series
N3	ø5/32" One-touch fitting	10-SY3000
N7	ø1/4" One-touch fitting	10-SY3000
N3	ø5/32" One-touch fitting	10-SY5000
N7	ø1/4" One-touch fitting	10-SY5000
N9	ø5/16" One-touch fitting	10-SY5000
N9	ø5/16" One-touch fitting	10-SY7000
N11	ø3/8" One-touch fitting	10-SY7000

Manual override

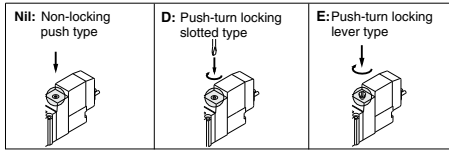

CE-compliant

Nil	—
Q	CE-compliant

Note) AC-type models that are CE-compliant have DIN terminals only.

Light/Surge voltage suppressor

Electrical entry for G, H, L, M, W

Nil	Without light/surge voltage suppressor
S	With light/surge voltage suppressor
Z	With light/surge voltage suppressor
R	With surge voltage suppressor (Non-polar type)
U	With light/surge voltage suppressor (Non-polar type)

* For AC voltage valves there is no "S" option. It is already built into the rectifier circuit.
* Power saving circuit is only available for the "Z" type.

Electrical entry for D, Y (10-SY500/7000 only)

Nil	Without light/surge voltage suppressor
S	With surge voltage suppressor (Non-polar type)
Z	With light/surge voltage suppressor (Non-polar type)

* DOZ and YOZ are not available.
* For AC voltage valves there is no "S" option. It is already built into the rectifier circuit.

Electrical entry

24, 12, 6, 5, 3 VDC/100, 110, 200, 220 VAC				24, 12 VDC/100, 110, 200, 220 VAC	24, 12, 6, 5, 3 VDC
Grommet	L plug connector	M plug connector		DIN terminal (10-SY5000/7000 only) D, Y: With connector	M8 connector
G: Lead wire length 300 mm 	L: With lead wire (Length 300 mm) 	M: With lead wire (Length 300 mm) 	MN: Without lead wire 	DO, YO: Without connector 	WO: Without connector cable
H: Lead wire length 600 mm 	LN: Without lead wire 	LO: Without connector 	MO: Without connector 	W□: With connector cable (Note 2) 	
Manifold mounting	●	●	●	— (Note 1)	●
CE-compliant	●	●	●	●	●

Note 1) The DIN terminal of the 10-SY3000 series cannot be mounted on a standard manifold. For details, refer to page 174.
Note 2) Enter the cable length symbols in □. Please be sure to fill in the blank referring to page 176.
Note 3) When ordering a single unit of the cassette type solenoid valve, the bushing assembly is included.
* LN, MN type: With 2 sockets.
* "Y" type is a DIN terminal conforming to EN-175301-803C (former DIN43650C). For details, refer to page 173.
* For connector cable of M8 connector, refer to page 176.
* M8 connector conforming to IEC60947-5-2 standard is also available. Refer to page 168 for details.
* Refer to page 173 for the lead wire length of L and M plug connectors.
* Refer to page 174 for the connector assembly with cover for L and M plug connectors.

Directional Control Valves

Air Cylinders

Rotary Actuators

Air Grippers

Air Preparation Equipment

Modular F. R.

Pressure Control Equipment

Fittings & Tubing

Flow Control Equipment

Pressure Switches/Pressure Sensors

Specifications

Series	10-SY3000	10-SY5000	10-SY7000	
Fluid	Air			
Internal pilot operating pressure range (MPa)	2 position single	0.15 to 0.7		
	2 position double	0.1 to 0.7		
	3 position	0.2 to 0.7		
Ambient and fluid temperature (°C)	Max. 50			
Max. operating frequency (Hz)	2 position double	10	5	5
	3 position	3	3	3
Manual override (Manual operation)	Non-locking push type, Push-turn locking slotted type, Push-turn locking lever type			
Pilot exhaust method	Main/Pilot valve common exhaust			
Lubrication	Not required			
Mounting position	Unrestricted			
Impact/Vibration resistance ^{Note)}	150/30			
Enclosure	Dust proof (+ DIN terminal, M8 connector: IP65)			

Note) Impact resistance: No malfunction occurred when it was tested in the axial direction and at right angles to the main valve and armature in both energized and de-energized states once for each condition.

Vibration resistance: No malfunction occurred in a one-sweep test between 45 and 2000 Hz. Test was performed in both energized and de-energized states in the axial direction and at right angles to the main valve and armature. (Default settings)

* Based on IEC60529

Solenoid Specifications

Electrical entry		Grommet (G), (H) L plug connector (L) M plug connector (M) DIN terminal (D), (Y) M8 connector (W)	
		G, H, L, M, W	D, Y
Coil rated voltage (V)	DC	24, 12, 6, 5, 3	
	AC 50/60 Hz	100, 110, 200, 220	
Allowable voltage fluctuation		±10% of rated voltage *	
Power consumption (W)	DC	0.35 [With indicator light: 0.4 (DIN terminal with indicator light: 0.45)]	
	With power saving circuit	0.1 (With indicator light only) * [Starting 0.4, Holding 0.1]	
Apparent power (VA) *	AC	100 V	0.78 (With indicator light: 0.81) [0.78 (With indicator light: 0.87)]
		110 V [115 V]	0.86 (With indicator light: 0.89) [0.94 (With indicator light: 0.97)]
		200 V	1.18 (With indicator light: 1.22) [1.15 (With indicator light: 1.30)]
		220 V [230 V]	1.30 (With indicator light: 1.34) [1.42 (With indicator light: 1.46)] [1.27 (With indicator light: 1.46)] [1.39 (With indicator light: 1.60)]
Surge voltage suppressor		Diode (Varistor is for DIN terminal and non-polar)	
Indicator light		LED (AC of DIN connector is neon light.)	

* Common between 110 VAC and 115 VAC, and between 220 VAC and 230 VAC.

* For 115 VAC and 230 VAC, the allowable voltage is -15% to +5% of rated voltage.

* For details, refer to page 171.

Response Time

Note) Based on dynamic performance test, JIS B 8375-1981. (Coil temperature: 20°C, at rated voltage)

10-SY3000

Actuation type	Response time (ms) (at the pressure of 0.5 MPa)		
	Without surge voltage suppressor	With surge voltage suppressor	
		S, Z type	R, U type
2 position single	12 or less	15 or less	12 or less
2 position double	10 or less	13 or less	10 or less
3 position	15 or less	20 or less	16 or less

10-SY5000

Actuation type	Response time (ms) (at the pressure of 0.5 MPa)		
	Without surge voltage suppressor	With surge voltage suppressor	
		S, Z type	R, U type
2 position single	19 or less	26 or less	19 or less
2 position double	18 or less	22 or less	18 or less
3 position	32 or less	38 or less	32 or less

10-SY7000

Actuation type	Response time (ms) (at the pressure of 0.5 MPa)		
	Without light/surge voltage suppressor	With light/surge voltage suppressor	
		S, Z type	R, U type
2 position single	31 or less	38 or less	33 or less
2 position double	27 or less	30 or less	28 or less
3 position	50 or less	56 or less	50 or less

Weight

10-SY3000

Valve model	Actuation type		Port size	Weight (g)		
			A, B	Gro-mmet	L/M plug connector	M8 Connector
10-SY3□60-□-M5	2 position	Single	M5 x 0.8	49	51	55
		Double		70	73	81
	3 position	Closed center		73	76	84
		Exhaust center				
Pressure center						
10-SY3□60-□-C4	2 position	Single		C4 (ø4 One-touch fitting)	62	61
		Double	80		83	91
	3 position	Closed center	82		86	94
		Exhaust center				
Pressure center						
10-SY3□60-□-C6	2 position	Single	C6 (ø6 One-touch fitting)		55	57
		Double		76	79	87
	3 position	Closed center		78	82	90
		Exhaust center				
Pressure center						

10-SY7000

Valve model	Actuation type		Port size	Weight (g)			
			A, B	Gro-mmet	L/M plug connector	DIN terminal	M8 Connector
10-SY7□60-□-02	2 position	Single	1/4	103	105	126	109
		Double		125	128	170	136
	3 position	Closed center		133	136	178	144
		Exhaust center					
Pressure center							
10-SY7□60-□-C8	2 position	Single		C8 (ø8 One-touch fitting)	138	139	160
		Double	160		163	205	171
	3 position	Closed center	168		171	213	179
		Exhaust center					
Pressure center							
10-SY7□60-□-C10	2 position	Single	C10 (ø10 One-touch fitting)		123	125	146
		Double		145	149	191	157
	3 position	Closed center		153	157	199	165
		Exhaust center					
Pressure center							

10-SY5000

Valve model	Actuation type		Port size	Weight (g)			
			A, B	Gro-mmet	L/M plug connector	DIN terminal	M8 Connector
10-SY5□60-□-01	2 position	Single	1/8	67	69	90	71
		Double		91	94	136	102
	3 position	Closed center		97	100	142	108
		Exhaust center					
Pressure center							
10-SY5□60-□-C4	2 position	Single		C4 (ø4 One-touch fitting)	91	93	114
		Double	113		116	158	124
	3 position	Closed center	119		122	164	130
		Exhaust center					
Pressure center							
10-SY5□60-□-C6	2 position	Single	C6 (ø6 One-touch fitting)		86	88	109
		Double		108	111	153	119
	3 position	Closed center		114	117	159	125
		Exhaust center					
Pressure center							
10-SY5□60-□-C8	2 position	Single		C8 (ø8 One-touch fitting)	78	80	101
		Double	100		103	145	111
	3 position	Closed center	106		109	151	117
		Exhaust center					
Pressure center							

Directional Control Valves

Air Cylinders

Rotary Actuators

Air Grippers

Air Preparation Equipment

Modular F. R.

Pressure Control Equipment

Fittings & Tubing

Flow Control Equipment

Pressure Switches/ Pressure Sensors

Manifold Option

■ Individual SUP block assembly

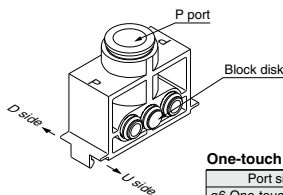

One-touch fitting (Metric size)

Port size	Assembly part no.	Applicable series
ø6 One-touch fitting	SY3000-54-2C(-Q)	10-SY3000
ø8 One-touch fitting	SY3000-54-1C(-Q)	10-SY3000
ø10 One-touch fitting	SY5000-54-1C(-Q)	10-SY5000
ø12 One-touch fitting	SY7000-54-1C(-Q)	10-SY7000

One-touch fitting (Inch size)

Port size	Assembly part no.	Applicable series
ø5/16" One-touch fitting	SY3000-54-3C(-Q)	10-SY3000
ø3/8" One-touch fitting	SY5000-54-2C(-Q)	10-SY5000
ø3/8" One-touch fitting	SY7000-54-3C(-Q)	10-SY7000

■ Individual EXH block assembly

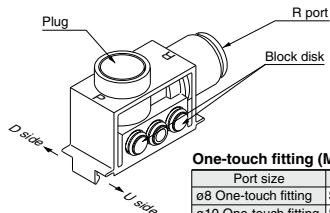

One-touch fitting (Metric size)

Port size	Assembly part no.	Applicable series
ø8 One-touch fitting	SY3000-55-1B(-Q)	10-SY3000
ø10 One-touch fitting	SY5000-55-1B(-Q)	10-SY5000
ø12 One-touch fitting	SY7000-55-1B(-Q)	10-SY7000

One-touch fitting (Inch size)

Port size	Assembly part no.	Applicable series
ø5/16" One-touch fitting	SY3000-55-2B(-Q)	10-SY3000
ø3/8" One-touch fitting	SY5000-55-2B(-Q)	10-SY5000
ø3/8" One-touch fitting	SY7000-55-3B(-Q)	10-SY7000

[When supplying the manifold with 2 different supply pressures.]

Specify arrangement of individual SUP block assembly on the manifold specification sheet. (When using 10-SS5Y□-60-□□D, block disk is assembled on D side.)

<Manifold model no.: 10-SS5Y $\frac{3}{8}$ -60-□□D>

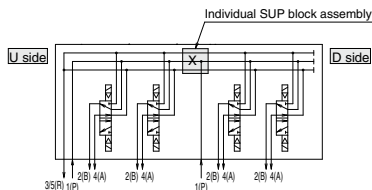

[When 2 different EXH passages are required.]

Specify arrangement of individual EXH block assembly on the manifold specification sheet. (When using 10-SS5Y□-60-□□D, block disk is assembled on D side.)

<Manifold model no.: 10-SS5Y $\frac{3}{8}$ -60-□□D>

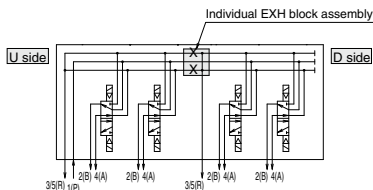

[When a different supply pressure is required for only a middle valve.]

Specify arrangement of individual SUP block assembly and SUP block disk on the manifold specification sheet.

(Applicable manifold model no.: 10-SS5Y□-60-□□B)

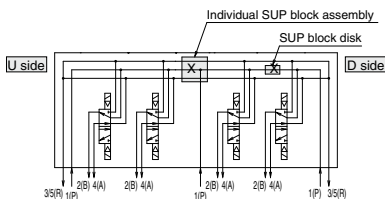

[When a separate exhaust passage is needed on only a middle valve.]

Specify arrangement of individual EXH block assembly and EXH block disk on the manifold specification sheet.

(Applicable manifold model no.: 10-SS5Y□-60-□□B)

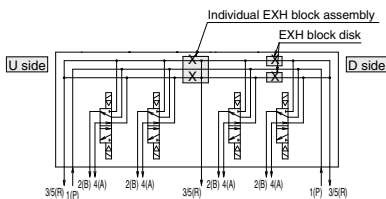

Manifold Option

■ SUP block disk

By installing a SUP block disk in the pressure supply passage of a manifold valve, it is possible to supply two or more different high and low pressures to one manifold. (This is the same block disk used with the individual SUP block assembly.)



Series	Part no.
10-SY3000	SY3000-52-6A
10-SY5000	SY5000-52-4A
10-SY7000	SY7000-70-2A

■ EXH block disk

By installing an EXH block disk in the exhaust passage of a manifold valve, it is possible to divide the valve's exhaust so that it does not affect another valve. (Two block disks are needed to separate both EXH passages. It is the same block disk that is used in the individual EXH block assembly.)



Series	Part no.
10-SY3000	SY3000-52-6A
10-SY5000	SY5000-52-4A
10-SY7000	SY7000-70-2A

■ Label for block disk

The labels shown below are used on manifold stations containing SUP/EXH block disk(s) to show their location. (3 pcs. each)

VZ3000-123-1A

Label for SUP block disk Label for EXH block disk Label for SUP/EXH block disk



* When a block disk is concurrently ordered by specifying it on the manifold specification sheet, etc., a label will be attached to the position where the block disk is mounted.

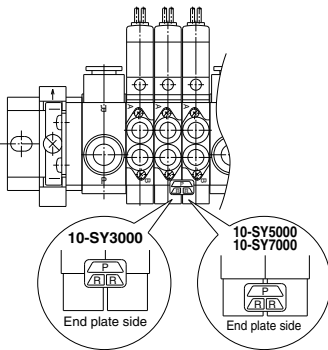

■ Plug

These are inserted in unused cylinder ports and SUP, EXH ports. Purchase orders are available in units of 10 pieces.

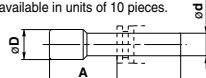

Dimensions

Applicable fittings size ød	Model	A	L	D
4	10-KQP-04	16	32	6
6	10-KQP-06	18	35	8
8	10-KQP-08	20.5	39	10
10	10-KQP-10	22	43	12
12	10-KQP-12	24	45.5	14
5/32"	10-KQP-03	16	32	6
1/4"	10-KQP-07	18	35	8.5
5/16"	10-KQP-09	20.5	39	10
3/8"	10-KQP-11	22	43	11.5

■ DIN Rail Dimensions/Weight for 10-SY3000/5000

VZ1000-11-1-□

◆ Refer to the L dimension tables

* Enter a number from the DIN rail dimension table below.

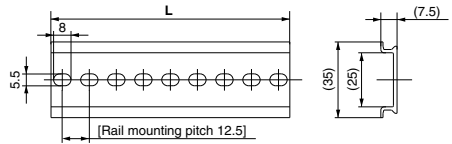

No.	0	1	2	3	4	5	6	7	8	9
L dimension	98	110.5	123	135.5	148	160.5	173	185.5	198	210.5
Weight (g)	17.6	19.9	22.1	24.4	26.6	28.9	31.1	33.4	35.6	37.9

No.	10	11	12	13	14	15	16	17	18	19
L dimension	223	235.5	248	260.5	273	285.5	298	310.5	323	335.5
Weight (g)	40.1	42.4	44.6	46.9	49.1	51.4	53.6	55.9	58.1	60.4

No.	20	21	22	23	24	25	26	27	28	29
L dimension	348	360.5	373	385.5	398	410.5	423	435.5	448	460.5
Weight (g)	62.6	64.9	67.1	69.4	71.6	73.9	76.1	78.4	80.6	82.9

■ DIN Rail Dimensions/Weight for 10-SY7000

VZ1000-11-4-□

◆ Refer to the L dimension tables

* Enter a number from the DIN rail dimension table below.

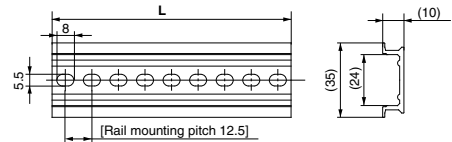

No.	0	1	2	3	4	5	6	7	8	9
L dimension	98	110.5	123	135.5	148	160.5	173	185.5	198	210.5
Weight (g)	24.8	28	31.1	34.3	37.4	40.6	43.8	46.9	50.1	53.3

No.	10	11	12	13	14	15	16	17	18	19
L dimension	223	235.5	248	260.5	273	285.5	298	310.5	323	335.5
Weight (g)	56.4	59.6	62.7	65.9	69.1	72.2	75.4	78.6	81.7	84.9

No.	20	21	22	23	24	25	26	27	28	29
L dimension	348	360.5	373	385.5	398	410.5	423	435.5	448	460.5
Weight (g)	88	91.2	94.4	97.5	100.7	103.9	107	110.2	113.3	116.5

(Note) For DIN rail mounting, refer to page 175.

Construction

Series 10-SY

Symbol

2 position single

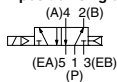

2 position single

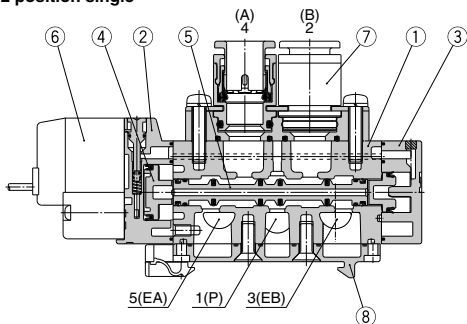

Symbol

2 position double

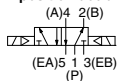

2 position double

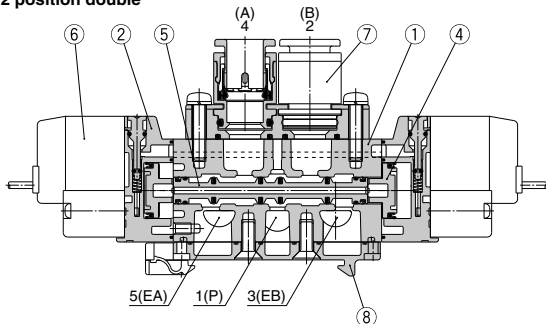

Symbol

3 position closed center



3 position closed center / exhaust center / pressure center

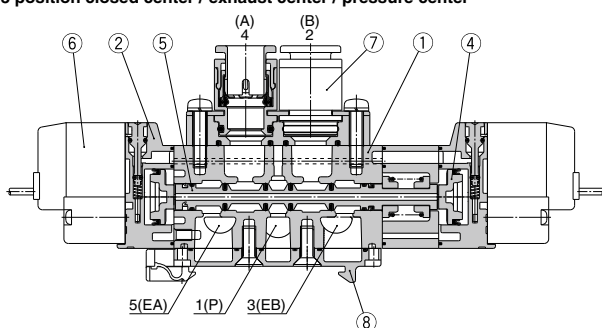

3 position exhaust center

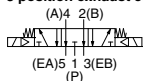

3 position pressure center

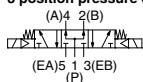

(This figure shows a closed center type.)

Component Parts

No.	Description	Material	Note
1	Body	Aluminum die-casted (10-SY3000: Zinc die-casted)	White
2	Adapter plate	Resin	White
3	End plate	Resin	White
4	Piston	Resin	—
5	Spool valve assembly	Aluminum/H-NBR	—

Replacement Parts

No.	Description	No.
6	Pilot valve assembly	Refer to "How to Order Pilot Valve Assembly" on the WEB catalog (SY series).
7	Port block assembly	Refer to "How to Order Port Block Assembly" on the WEB catalog (SY series).
8	Bottom cover assembly ^(Note)	SY3000-41-2A (with screw, gasket) SY5000-41-2A (with screw, gasket)

Note) There is no bottom cover assembly available for 10-SY7000.

Dimensions

[]: AC

10-SS5Y3-60- Stations U

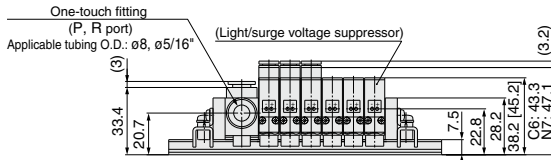
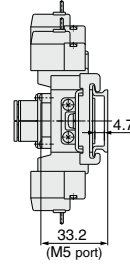
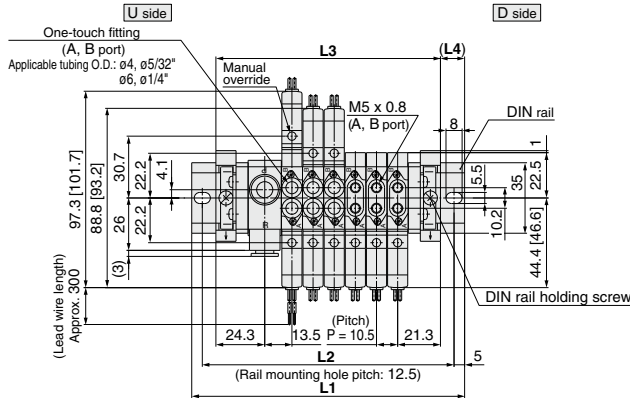

Stations	2 stations	3	4	5	6	7	8	9	10 stations
L1	98	110.5	123	135.5	135.5	148	160.5	173	185.5
L2	87.5	100	112.5	125	125	137.5	150	162.5	175
L3	69.5	80	90.5	101	111.5	122	132.5	143	153.5
L4	14	15	16	17	12	13	14	15	16

10-SS5Y3-60- Stations D

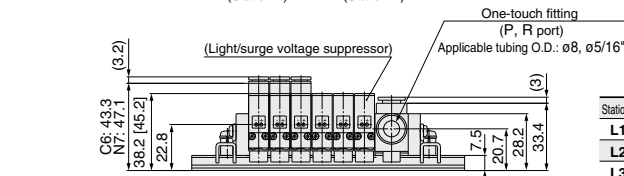
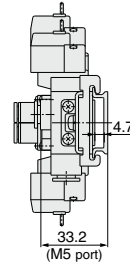
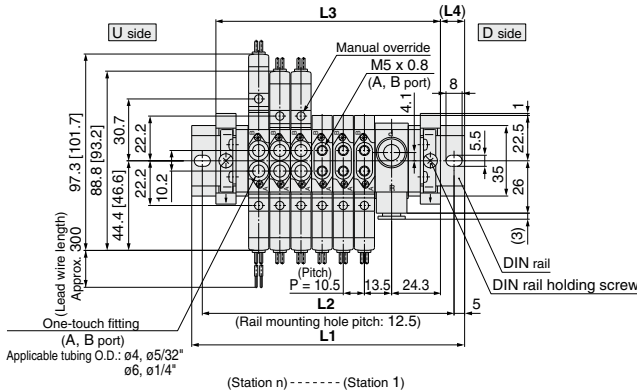

Stations	2 stations	3	4	5	6	7	8	9	10 stations
L1	98	110.5	123	135.5	135.5	148	160.5	173	185.5
L2	87.5	100	112.5	125	125	137.5	150	162.5	175
L3	69.5	80	90.5	101	111.5	122	132.5	143	153.5
L4	14	15	16	17	12	13	14	15	16

Directional Control Valves
Air Cylinders
Rotary Actuators
Air Grippers
Air Preparation Equipment
Modular F. R.
Pressure Control Equipment
Fittings & Tubing
Flow Control Equipment
Pressure Switches/ Pressure Sensors

Dimensions

[]: AC

10-SS5Y3-60- Stations B

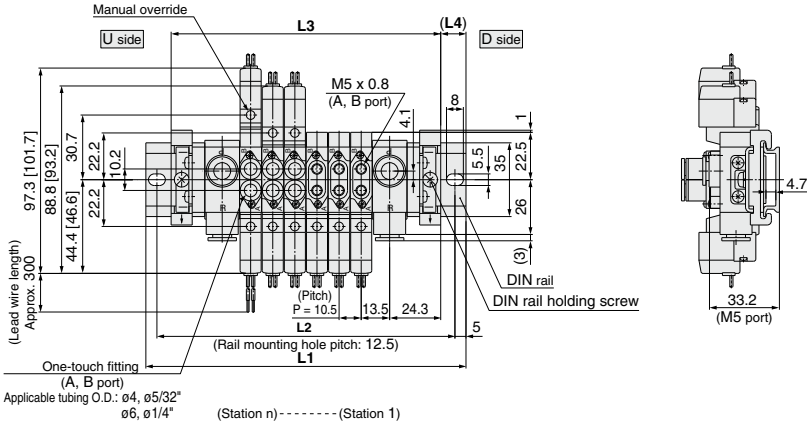

(A, B port)
Applicable tubing O.D.: $\phi 4, \phi 5/32''$
 $\phi 6, \phi 1/4''$
(Station n) ----- (Station 1)

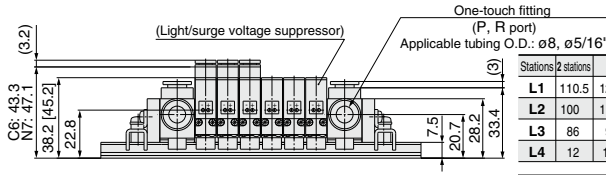

Stations	2 stations	3	4	5	6	7	8	9	10 stations
L1	110.5	123	135.5	148	160.5	173	173	185.5	198
L2	100	112.5	125	137.5	150	162.5	162.5	175	187.5
L3	86	96.5	107	117.5	128	138.5	149	159.5	170
L4	12	13	14	15	16	17	12	13	14

Stations	11 stations	12	13	14	15	16	17	18	19	20 stations
L1	210.5	223	235.5	235.5	248	260.5	273	285.5	298	310.5
L2	200	212.5	225	225	237.5	250	262.5	275	287.5	300
L3	180.5	191	201.5	212	222.5	233	243.5	254	264.5	275
L4	15	16	17	11.5	12.5	13.5	14.5	15.5	16.5	17.5

L plug connector (L)

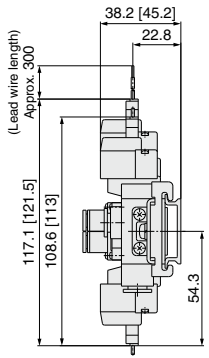

M plug connector (M)

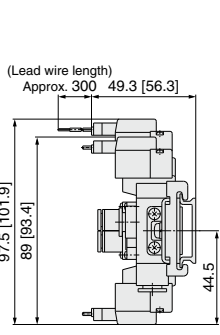

M8 connector (WO)

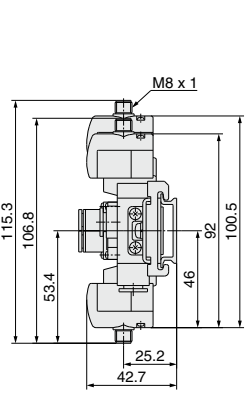

Note) Refer to page 176 for dimensions of connector types.

10-SS5Y5-60-Stations U

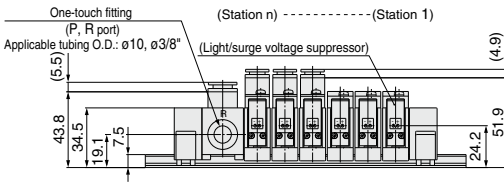
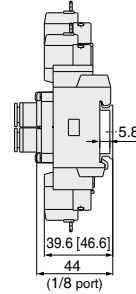
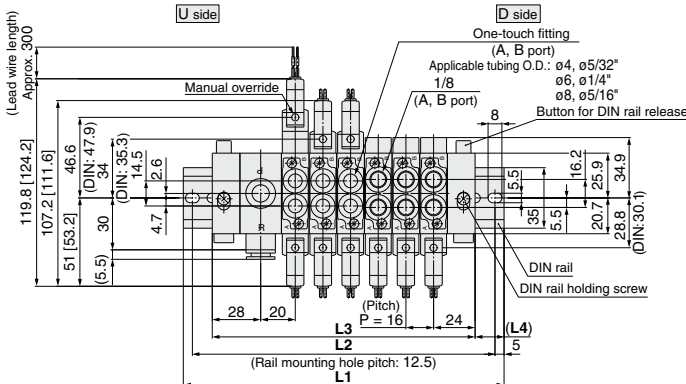

Stations	2 stations	3	4	5	6	7	8	9	10 stations
L1	123	135.5	148	160.5	185.5	198	210.5	235.5	248
L2	112.5	125	137.5	150	175	187.5	200	225	237.5
L3	88	104	120	136	152	168	184	200	216
L4	17.5	15.5	14	12	16.5	15	13	17.5	16

10-SS5Y5-60-Stations D

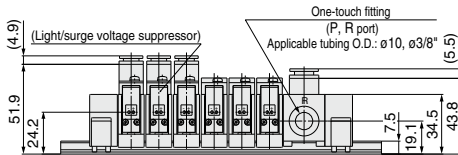
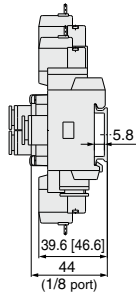
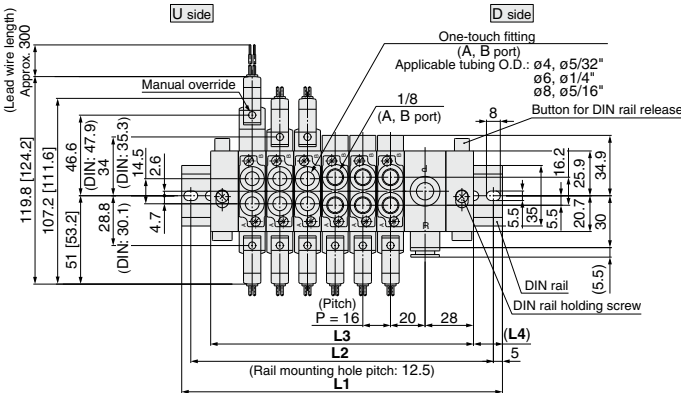

Stations	2 stations	3	4	5	6	7	8	9	10 stations
L1	123	135.5	148	160.5	185.5	198	210.5	235.5	248
L2	112.5	125	137.5	150	175	187.5	200	225	237.5
L3	88	104	120	136	152	168	184	200	216
L4	17.5	15.5	14	12	16.5	15	13	17.5	16

Directional Control Valves

Air Cylinders

Rotary Actuators

Air Grippers

Air Preparation Equipment

Modular F. R.

Pressure Control Equipment

Fittings & Tubing

Flow Control Equipment

Pressure Switches/Pressure Sensors

Dimensions

[] : AC

10-SS5Y5-60- Stations B

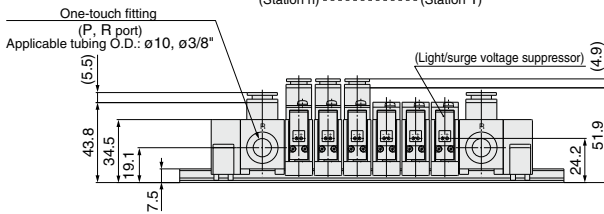
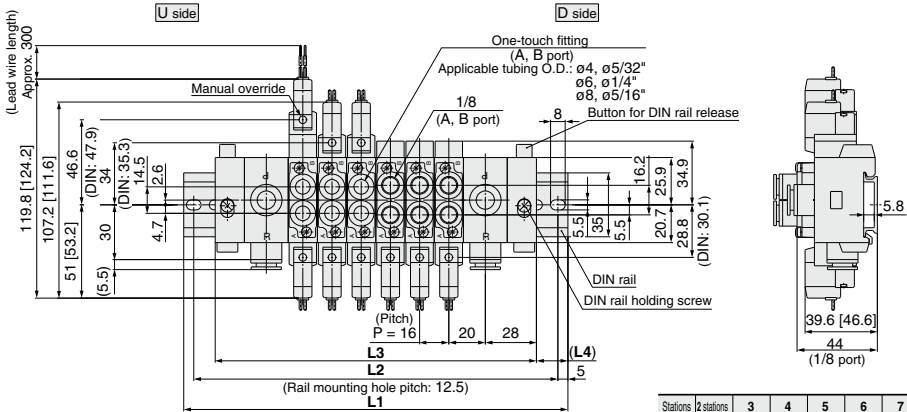

Stations	2 stations	3	4	5	6	7	8 stations
L1	135.5	160.5	173	185.5	210.5	223	235.5
L2	125	150	162.5	175	200	212.5	225
L3	112	128	144	160	176	192	208
L4	11.5	16	14.5	12.5	17.5	15.5	13.5

Stations	9 stations	10	11	12	13	14	15 stations
L1	248	273	285.5	298	323	335.5	348
L2	237.5	262.5	275	287.5	312.5	325	337.5
L3	224	240	256	272	288	304	320
L4	12	16.5	14.5	13	17.5	15.5	14

Stations	16 stations	17	18	19	20 stations
L1	360.5	385.5	398	410.5	435.5
L2	350	375	387.5	400	425
L3	336	352	368	384	400
L4	12	16.5	15	13	17.5

L plug connector (L)

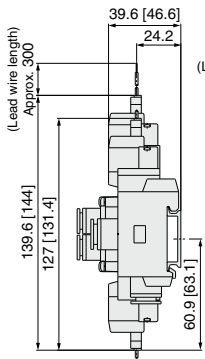

M plug connector (M)

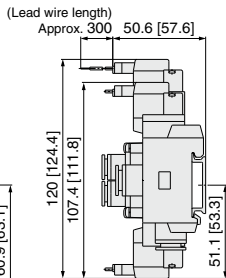

DIN terminal (D, Y)

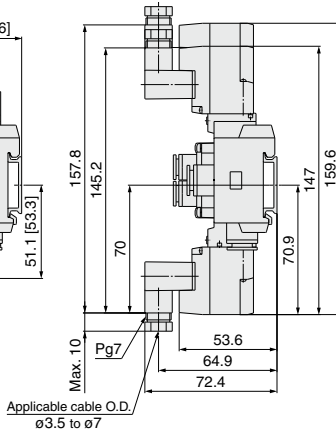

M8 connector (WO)

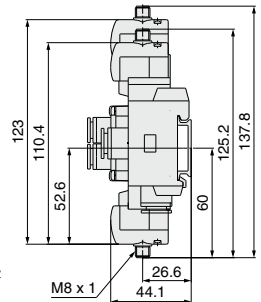

Note) Refer to page 176 for dimensions of connector types.

10-SS5Y7-60- Stations U

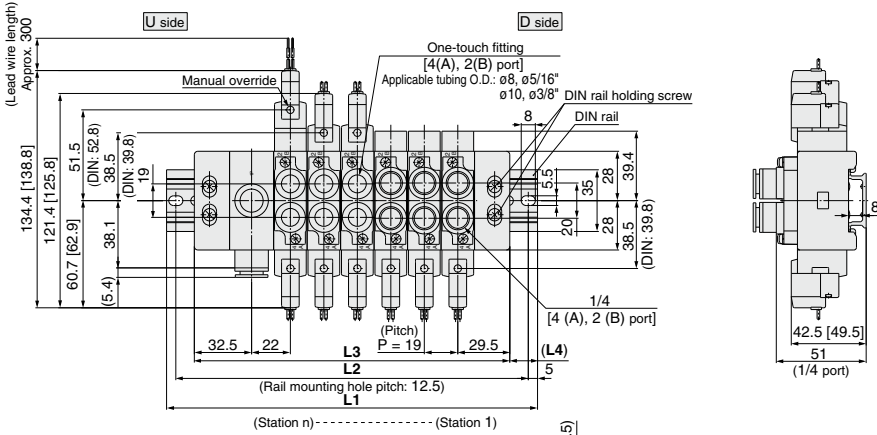

Stations	2 stations	3	4	5	6	7	8	9	10 stations
L1	135.5	148	173	185.5	210.5	223	248	260.5	285.5
L2	125	137.5	162.5	175	200	212.5	237.5	250	275
L3	103	122	141	160	179	198	217	236	255
L4	16	13	16	12.5	15.5	12.5	15.5	12	15

10-SS5Y7-60- Stations D

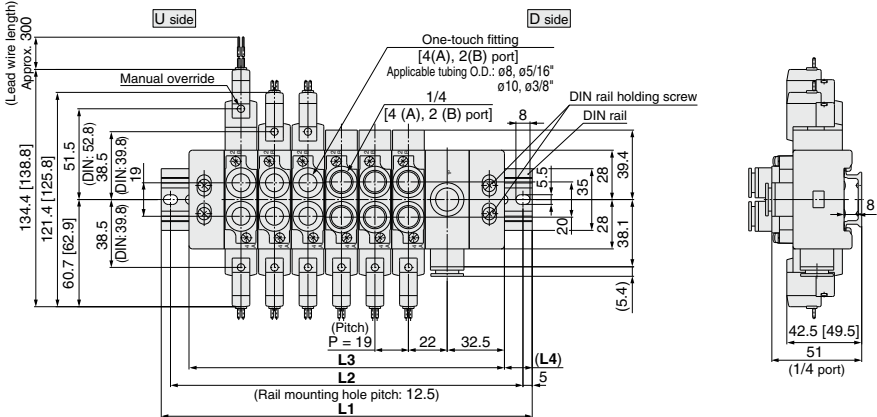

Stations	2 stations	3	4	5	6	7	8	9	10 stations
L1	135.5	148	173	185.5	210.5	223	248	260.5	285.5
L2	125	137.5	162.5	175	200	212.5	237.5	250	275
L3	103	122	141	160	179	198	217	236	255
L4	16	13	16	12.5	15.5	12.5	15.5	12	15

Dimensions

[] : AC

10-SS5Y7-60- Stations B

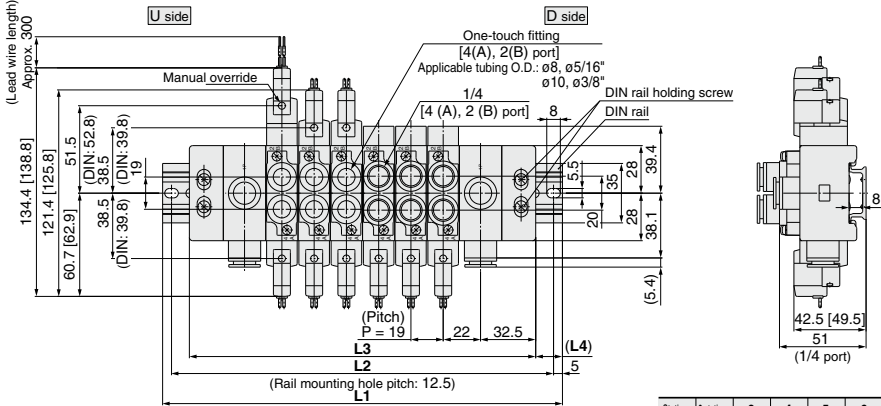

(Station n) ----- (Station 1)

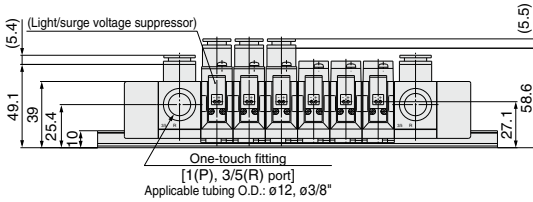

Stations	2 stations	3	4	5	6	7	8 stations
L1	160.5	173	198	210.5	235.5	248	273
L2	150	162.5	187.5	200	225	237.5	262.5
L3	128	147	166	185	204	223	242
L4	16	13	16	12.5	15.5	12.5	15.5

Stations	9 stations	10	11	12	13	14	15 stations
L1	285.5	310.5	323	348	360.5	385.5	410.5
L2	275	300	312.5	337.5	350	375	400
L3	261	280	299	318	337	356	375
L4	12	15	12	15	11.5	14.5	17.5

Stations	16 stations	17	18	19	20 stations
L1	423	448	460.5	485.5	498
L2	412.5	437.5	450	475	487.5
L3	394	413	432	451	470
L4	14.5	17.5	14	17	14

L plug connector (L)

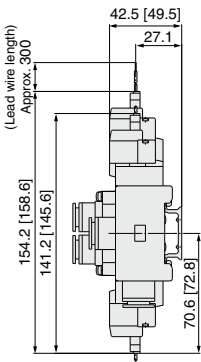

M plug connector (M)

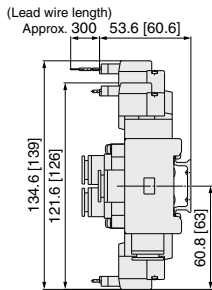

DIN terminal (D, Y)

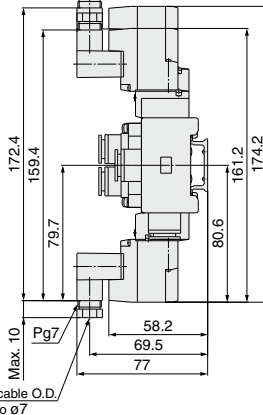

M8 connector (WO)

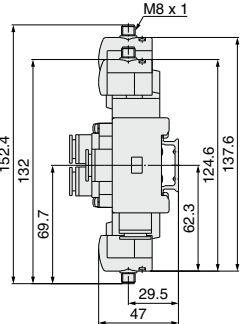

Note) Refer to page 176 for dimensions of connector types.

Type 41 Series 10-SY3000/5000/7000

5 Port Solenoid Valve Base Mounted Manifold Bar Stock Type/Individual Wiring

Note) AC-type models that are CE-compliant have DIN terminals only. **[Option]**



How to Order Manifold

Type 41/Compact type

10-SS5Y 5-41-05-C8

Clean series

Manifold series	
3	10-SY3000
5	10-SY5000

Stations	
02	2 stations
⋮	⋮
20	20 stations

* Includes the number of blanking plate assemblies.

Thread type

NII	Rc
F	G
N	NPT
T	NPTF

* Except for M5

A, B port size Thread piping

Symbol	Port size	Applicable series
M5	M5 x 0.8	10-SY3000
01	1/8	10-SY5000

One-touch fitting (Metric size)

Symbol	Port size	Applicable series
C4	ø4 One-touch fitting	10-SY3000
C6	ø6 One-touch fitting	10-SY5000
C6	ø6 One-touch fitting	10-SY5000
C8	ø8 One-touch fitting	10-SY5000

One-touch fitting (Inch size)

Symbol	Port size	Applicable series
N3	ø5/32" One-touch fitting	10-SY3000
N7	ø1/4" One-touch fitting	10-SY3000
N7	ø1/4" One-touch fitting	10-SY5000
N9	ø5/16" One-touch fitting	10-SY5000

CE-compliant

NII	—
Q	CE-compliant

Note) AC-type models that are CE-compliant have DIN terminals only.

Type 42/Common external pilot

10-SS5Y 5-42-05-C8

Clean series

Manifold series	
3	10-SY3000
5	10-SY5000
7	10-SY7000

Stations	
02	2 stations
⋮	⋮
20	20 stations

* Includes the number of blanking plate assemblies.

Thread type

NII	Rc
F	G
N	NPT
T	NPTF

CE-compliant

NII	—
Q	CE-compliant

Note) AC-type models that are CE-compliant have DIN terminals only.

A, B port size Thread piping

Symbol	Port size	Applicable series
01	1/8	10-SY3000
02	1/4	10-SY5000
02	1/4	10-SY7000

One-touch fitting (Metric size)

Symbol	Port size	Applicable series
C4	ø4 One-touch fitting	10-SY3000
C6	ø6 One-touch fitting	10-SY5000
C6	ø6 One-touch fitting	10-SY5000
C8	ø8 One-touch fitting	10-SY7000
C10	ø10 One-touch fitting	10-SY7000

One-touch fitting (Inch size)

Symbol	Port size	Applicable series
N3	ø5/32" One-touch fitting	10-SY3000
N7	ø1/4" One-touch fitting	10-SY3000
N7	ø1/4" One-touch fitting	10-SY5000
N9	ø5/16" One-touch fitting	10-SY5000
N11	ø3/8" One-touch fitting	10-SY7000

How to Order Manifold Assembly (Example)

Example

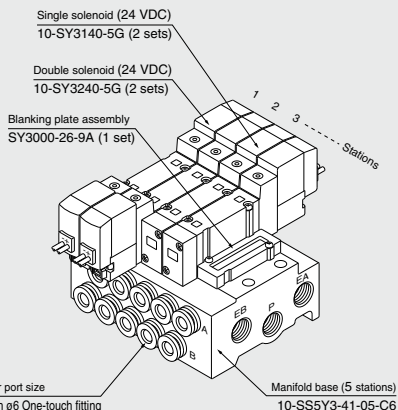

- 10-SSY3-41-05-C6... 1 set (Type 41, 5-station manifold base part no.)
- * 10-SY3240-5G 2 sets (Double solenoid part no.)
 - * 10-SY3140-5G 2 sets (Single solenoid part no.)
 - * SY3000-26-9A 1 set (Blanking plate assembly part no.)

The asterisk denotes the symbol for assembly. Prefix it to the part no. of the solenoid valve, etc.

Add the valve and option part number under the manifold base part number. For complex arrangements, specify them on the manifold specification sheet.

Directional Control Valves

Air Cylinders

Rotary Actuators

Air Grippers

Air Preparation Equipment

Modular F. R.

Pressure Control Equipment

Fittings & Tubing

Flow Control Equipment

Pressure Switches/Pressure Sensors



How to Order Valve

Note) AC-type models that are CE-compliant have DIN terminals only.

10-SY 5 2 40 - 5 L - -

• Clean series

Series •

3	10-SY3000
5	10-SY5000
7	10-SY7000

Actuation type •

1	2 position single
2	2 position double
3	3 position closed center
4	3 position exhaust center
5	3 position pressure center

Pilot type •

NII	Internal pilot
R	External pilot

Coil type •

NII	Standard
T	With power saving circuit (24 VDC, 12 VDC only)

* Power saving circuit is not available for D, Y, DO, YO or W□ types.

Rated voltage •

For DC

5	24 VDC
6	12 VDC
V	6 VDC
S	5 VDC
R	3 VDC

For AC (50/60 Hz)

1	100 VAC
2	200 VAC
3	110 VAC [115 VAC]
4	220 VAC [230 VAC]

* DC specifications of Type D, Y, DO and YO are only available with 12 and 24 VDC.

* For type W□, only DC voltage is available.
Note) AC-type models that are CE-compliant have DIN terminals only.

• CE-compliant

NII	—
Q	CE-compliant

Note) AC-type models that are CE-compliant have DIN terminals only.

• Made to Order

NII	—
X90	Main valve fluororubber (Refer to page 169.)

• Manual override

NII	Non-locking push type
D	Push-turn locking slotted type
E	Push-turn locking lever type

• Light/Surge voltage suppressor

Electrical entry for G, H, L, M, W

NII	Without light/surge voltage suppressor
S	With surge voltage suppressor
Z	With light/surge voltage suppressor
R	With surge voltage suppressor (Non-polar type)
U	With light/surge voltage suppressor (Non-polar type)

- * For AC voltage valves there is no "S" option. It is already built into the rectifier circuit.
- * For "R" and "U", only DC voltage is available.
- * Power saving circuit is only available for the "Z" type.

Electrical entry for D, Y

NII	Without light/surge voltage suppressor
S	With surge voltage suppressor (Non-polar type)
Z	With light/surge voltage suppressor (Non-polar type)

- * DOZ and YOZ are not available.
- * For AC voltage valves there is no "S" option. It is already built into the rectifier circuit.

Note) When ordering a single unit of the base mounted type solenoid valve, the mounting screws and gasket for the manifold are included.

• Electrical entry

		24, 12, 6, 5, 3 VDC/100, 110, 200, 220 VAC			24, 12 VDC/ 100, 110, 200, 220 VAC	24, 12, 6, 5, 3 VDC
		Grommet	L plug connector	M plug connector	DIN terminal	M8 connector
		G: Lead wire length 300 mm lead	L: With lead wire (Length 300 mm)	M: With lead wire (Length 300 mm)	(10-SY5000/7000 only) D: With connector DO: Without connector Y: With connector YO: Without connector	WO: Without connector cable W□: With connector cable ^{Note 2)}
		H: Lead wire length 600 mm	LN: Without lead wire LO: Without connector	MN: Without lead wire MO: Without connector	— ^{Note 1)}	
Manifold mounting	10-SY3000	●	●	●	●	●
	10-SY5000	●	●	●	●	●
	10-SY7000	●	●	●	●	●
CE-compliant	DC	●	●	●	●	●
	AC	—	—	—	●	—

Note 1) The DIN terminal of the 10-SY3000 series cannot be mounted on a standard manifold. For details, refer to page 174.

Note 2) Enter the cable length symbols in □. Please be sure to fill in the blank referring to page 176.

* LN, MN type: With 2 sockets.

* "Y" type is a DIN terminal conforming to EN-175301-803C (former DIN43650C). For details, refer to page 173.

* For connector cable of M8 connector, refer to page 176.

* M8 connector conforming to IEC60947-5-2 standard is also available. Refer to page 168 for details.

* Refer to page 173 for the lead wire length of L and M plug connectors.

* Refer to page 174 for the connector assembly with cover for L and M plug connectors.

Manifold Specifications

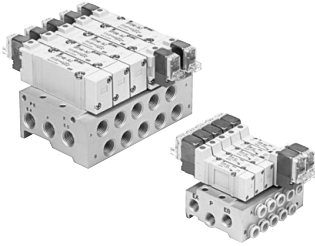

Model	10-SS5Y3-41(-Q)	10-SS5Y3-42(-Q)	10-SS5Y5-41(-Q)	10-SS5Y5-42(-Q)	10-SS5Y7-42(-Q)
Applicable valve	10-SY3□40		10-SY5□40		
Manifold type	Single base/B mount				
P (SUP)/R (EXH)	Common SUP, Common EXH				
Valve stations	2 to 20 stations ^{Note 1)}				
A, B port	Base				
Porting specifications	Side				
Port size	P, EA, EB port	1/8		1/4	
	A, B port	M5 x 0.8, C4 (ø4 One-touch fitting) C6 (ø6 One-touch fitting)	1/8 C4 (ø4 One-touch fitting) C6 (ø6 One-touch fitting)	1/8 C6 (ø6 One-touch fitting) C8 (ø8 One-touch fitting)	1/4 C6 (ø6 One-touch fitting) C8 (ø8 One-touch fitting)
Manifold base weight W (g) n: Stations	W = 30n + 50	W = 37n + 63	W = 61n + 101	W = 79n + 127	W = 100n + 151

Note 1) For more than 10 stations (more than 5 stations in case of 10-SS5Y7), supply pressure to P port on both sides and exhaust from EA/EB port on both sides.

Note 2) Refer to "Manifold Option" on page 148.

Flow Rate Characteristics

Model	Port size		Flow rate characteristics					
	1, 5, 3 (P, EA, EB)	4, 2 (A, B)	1 → 4/2 (P → A/B)			4/2 → 5/3 (A/B → EA/EB)		
			C (dm ³ /s(bar))	b	Cv	C (dm ³ /s(bar))	b	Cv
10-SS5Y3-41(-Q)	1/8	C6	0.75	0.19	0.18	0.81	0.23	0.20
10-SS5Y3-42(-Q)	1/8	C6	0.75	0.20	0.18	0.82	0.20	0.20
10-SS5Y5-41(-Q)	1/4	C8	1.8	0.23	0.44	1.9	0.16	0.45
10-SS5Y5-42(-Q)	1/4	C8	1.9	0.20	0.46	1.9	0.12	0.43
10-SS5Y7-42(-Q)	1/4	C10	3.0	0.25	0.75	3.0	0.12	0.66

Note) The values are for individually operated 2 position type manifold bases with 5 stations.

Directional Control Valves

Air Cylinders

Rotary Actuators

Air Grippers

Air Preparation Equipment

Modular F. R.

Pressure Control Equipment

Fittings & Tubing

Flow Control Equipment

Pressure Switches/ Pressure Sensors

10-SY3000: 10-SS5Y3-41-Stations-M5, C4, N3
C6, N7

[]: AC

Grommet (G)

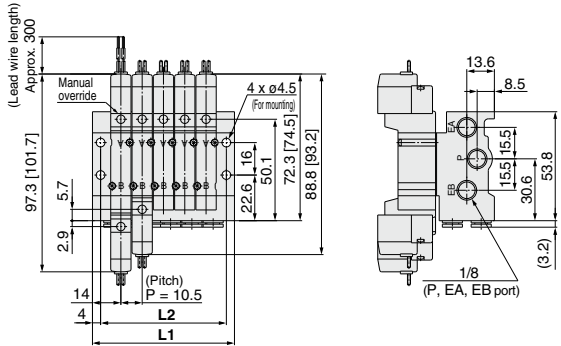

(Station 1) ----- (Station n)

For M5

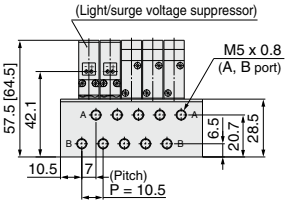
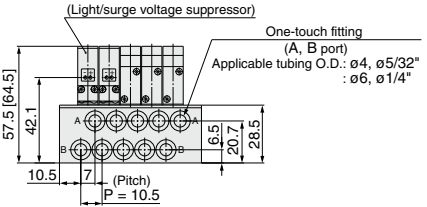

L plug connector (L)

M plug connector (M)

M8 connector (W0)

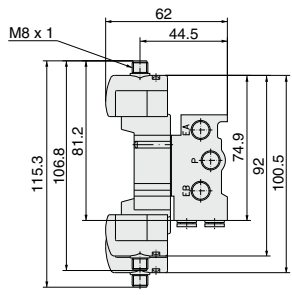
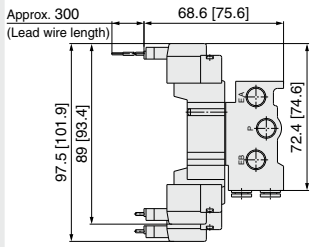
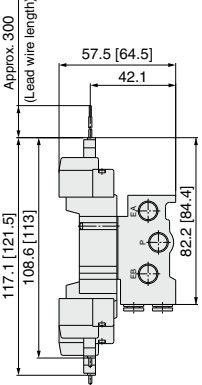

Note) Refer to page 176 for dimensions of connector types.

Stations	2 stations	3	4	5	6	7	8	9	10	11	12	13	14	15	16	17	18	19	20 stations
L1	38.5	49	59.5	70	80.5	91	101.5	112	122.5	133	143.5	154	164.5	175	185.5	196	206.5	217	227.5
L2	30.5	41	51.5	62	72.5	83	93.5	104	114.5	125	135.5	146	156.5	167	177.5	188	198.5	209	219.5

10-SY5000: 10-SS5Y5-41-Stations-01, C6, N7
C8, N9

[] : AC

Grommet (G)

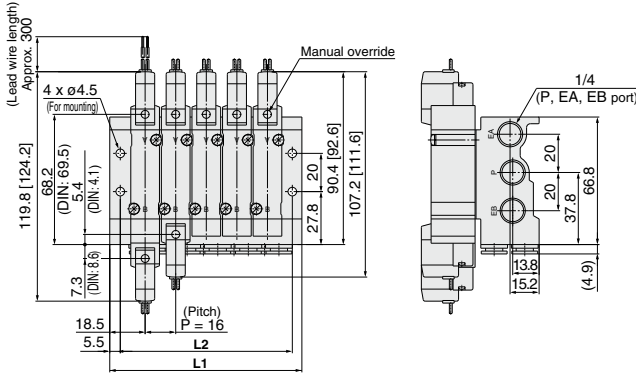

(Station 1) ----- (Station n)

For 1/8

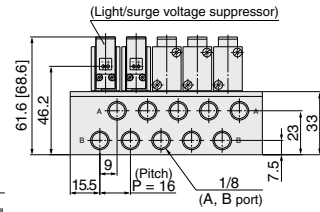
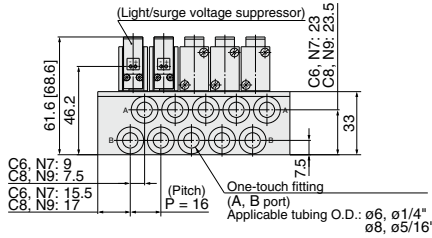

Applicable tubing O.D.: ø6, ø1/4", ø8, ø5/16"

L plug connector (L)

M plug connector (M)

DIN terminal (D, Y)

M8 connector (WO)

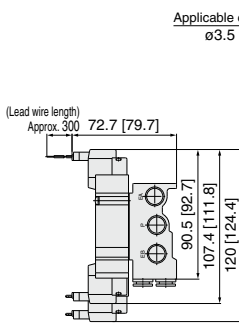
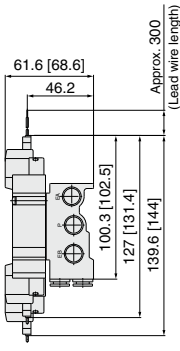

Applicable cable O.D.
ø3.5 to ø7

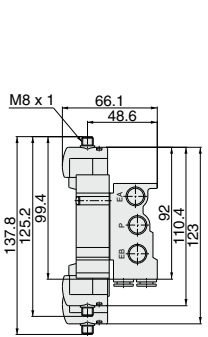
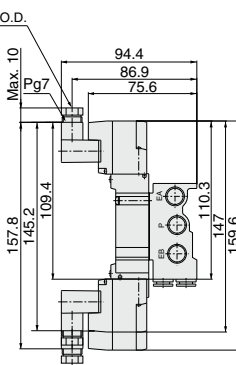

Note) Refer to page 176 for dimensions of connector types.

Stations	2 stations	3	4	5	6	7	8	9	10	11	12	13	14	15	16	17	18	19	20 stations
L1	52.5	68.5	84.5	100.5	116.5	132.5	148.5	164.5	180.5	196.5	212.5	228.5	244.5	260.5	276.5	292.5	308.5	324.5	340.5
L2	42	58	74	90	106	122	138	154	170	186	202	218	234	250	266	282	298	314	330

Directional Control Valves

Air Cylinders

Rotary Actuators

Air Grippers

Air Preparation Equipment

Modular F. R.

Pressure Control Equipment

Fittings & Tubing

Flow Control Equipment

Pressure Switches/ Pressure Sensors

10-SY3000: 10-SS5Y3-42- Stations - C4, N3
C6, N7

[]: AC

Grommet (G)

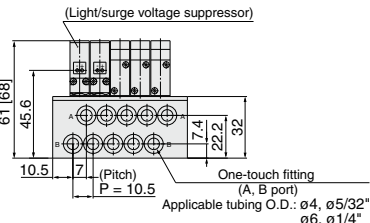
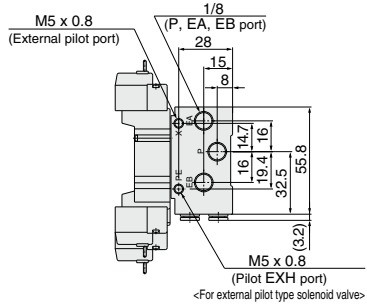
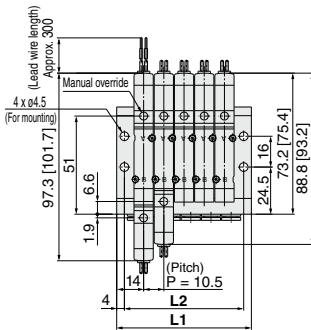

L plug connector (L)

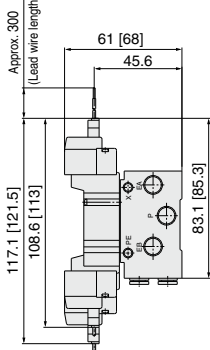

M plug connector (M)

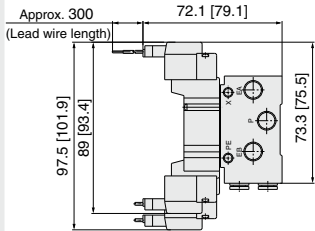

M8 connector (WO)

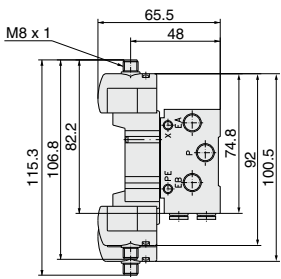

Note) Refer to page 176 for dimensions of connector types.

Stations	2 stations	3	4	5	6	7	8	9	10	11	12	13	14	15	16	17	18	19	20 stations
L1	38.5	49	59.5	70	80.5	91	101.5	112	122.5	133	143.5	154	164.5	175	185.5	196	206.5	217	227.5
L2	30.5	41	51.5	62	72.5	83	93.5	104	114.5	125	135.5	146	156.5	167	177.5	188	198.5	209	219.5

10-SY3000: 10-SS5Y3-42-Stations-01

[] : AC

Grommet (G)

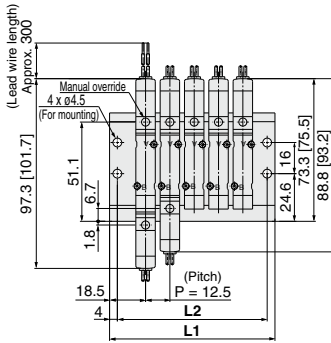

(Station 1) ----- (Station n)

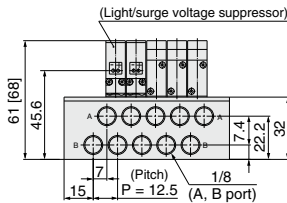
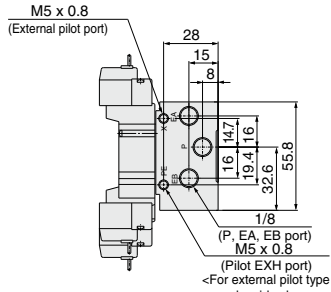

L plug connector (L)

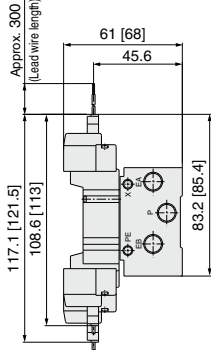

M plug connector (M)

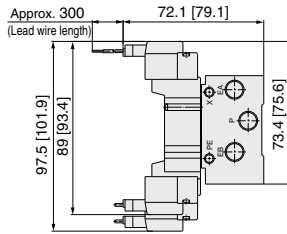

M8 connector (WO)

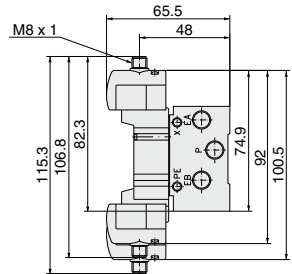

Note) Refer to page 176 for dimensions of connector types.

Stations	2 stations	3	4	5	6	7	8	9	10	11	12	13	14	15	16	17	18	19	20 stations
L1	47.5	60	72.5	85	97.5	110	122.5	135	147.5	160	172.5	185	197.5	210	222.5	235	247.5	260	272.5
L2	39.5	52	64.5	77	89.5	102	114.5	127	139.5	152	164.5	177	189.5	202	214.5	227	239.5	252	264.5

Directional Control Valves

Air Cylinders

Rotary Actuators

Air Grippers

Air Preparation Equipment

Modular F. R.

Pressure Control Equipment

Fittings & Tubing

Flow Control Equipment

Pressure Switches/
Pressure Sensors

10-SY5000: 10-SS5Y5-42- Stations - C6, N7
C8, N9

[] : AC

Grommet (G)

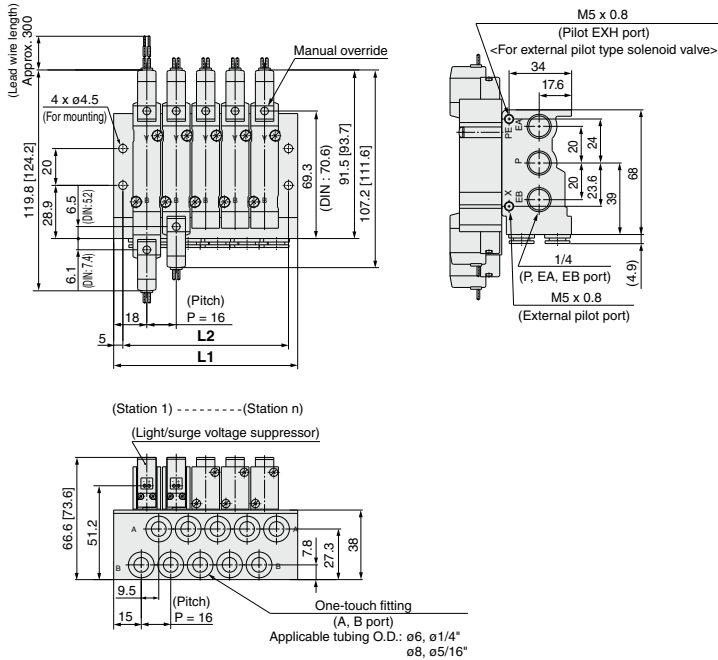

L plug connector (L)

M plug connector (M)

DIN terminal (D, Y)

M8 connector (WO)

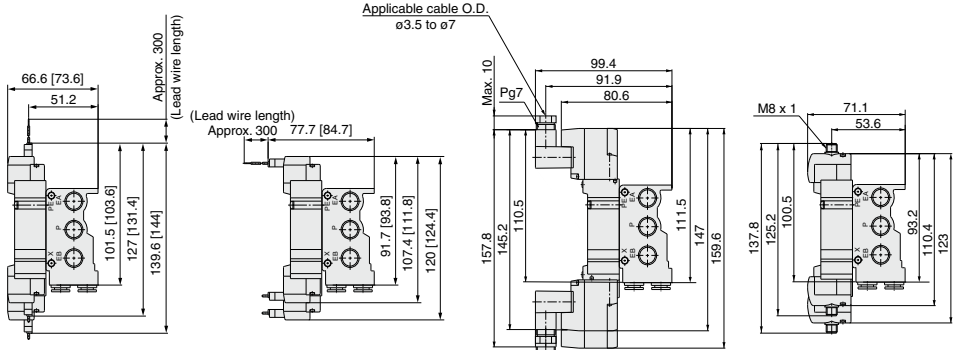

Note) Refer to page 176 for dimensions of connector types.

Stations	2 stations	3	4	5	6	7	8	9	10	11	12	13	14	15	16	17	18	19	20 stations
L1	52	68	84	100	116	132	148	164	180	196	212	228	244	260	276	292	308	324	340
L2	42	58	74	90	106	122	138	154	170	186	202	218	234	250	266	282	298	314	330

10-SY5000: 10-SS5Y5-42-Stations-02

[] : AC

Grommet (G)

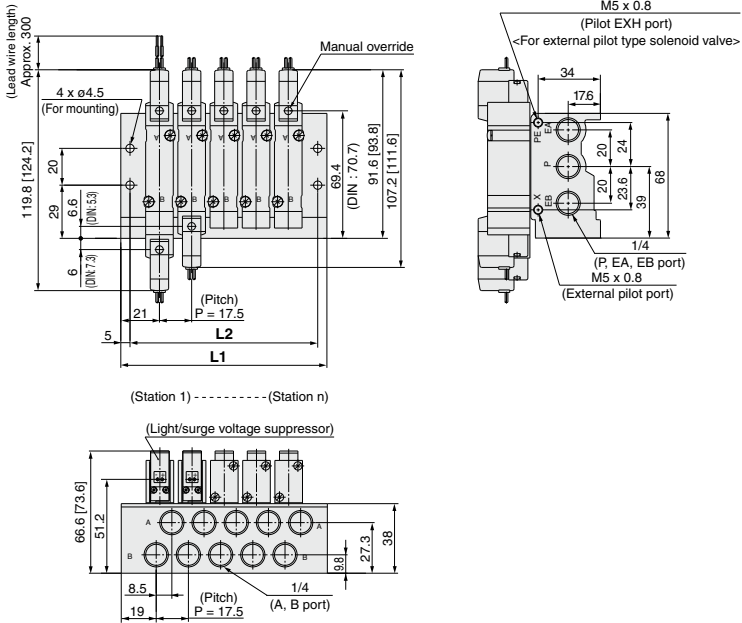

L plug connector (L)

M plug connector (M)

DIN terminal (D, Y)

M8 connector (WO)

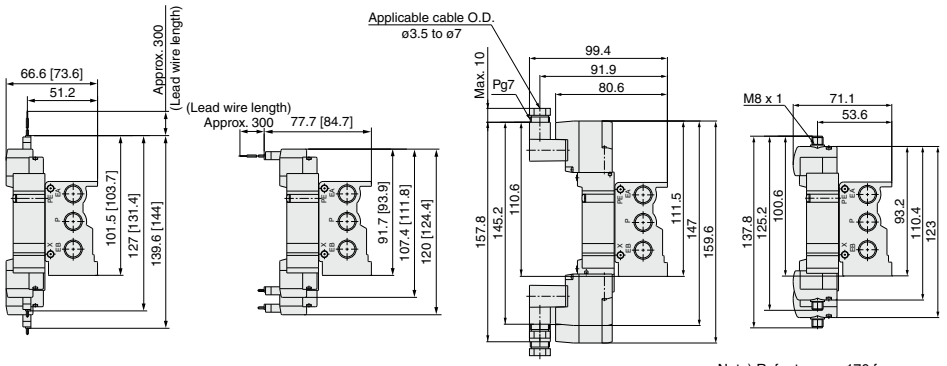

Note) Refer to page 176 for dimensions of connector types.

Stations	2 stations	3	4	5	6	7	8	9	10	11	12	13	14	15	16	17	18	19	20 stations
L1	59.5	77	94.5	112	129.5	147	164.5	182	199.5	217	234.5	252	269.5	287	304.5	322	339.5	357	374.5
L2	49.5	67	84.5	102	119.5	137	154.5	172	189.5	207	224.5	242	259.5	277	294.5	312	329.5	347	364.5

Directional Control Valves
Air Cylinders
Rotary Actuators
Air Grippers
Air Preparation Equipment
Modular F. R.
Pressure Control Equipment
Fittings & Tubing
Flow Control Equipment
Pressure Switches/
Pressure Sensors

10-SY7000: 10-SS5Y7-42- Stations -02, C10, N11

[] : AC

Grommet (G)

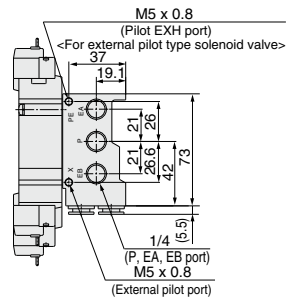
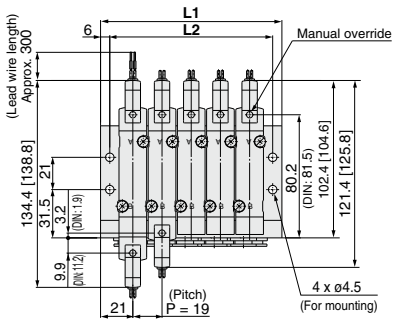

(Station 1) ----- (Station n)

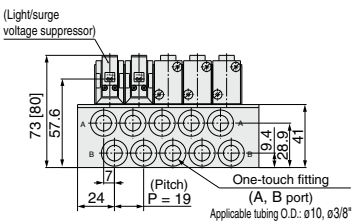

For 1/4

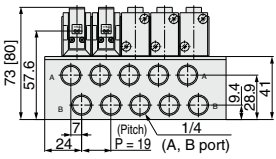

L plug connector (L)

M plug connector (M)

DIN terminal (D, Y)

M8 connector (WO)

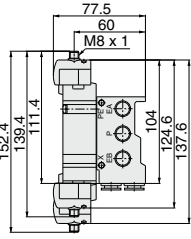
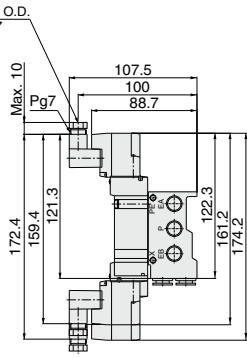
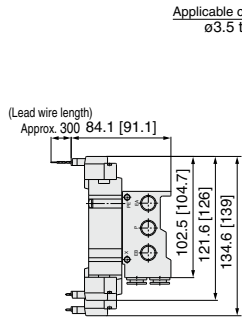
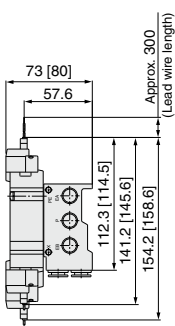

Note) Refer to page 176 for dimensions of connector types.

Stations	2 stations	3	4	5	6	7	8	9	10	11	12	13	14	15	16	17	18	19	20 stations
L1	61	80	99	118	137	156	175	194	213	232	251	270	289	308	327	346	365	384	403
L2	49	68	87	106	125	144	163	182	201	220	239	258	277	296	315	334	353	372	391

Type 43 Series 10-SY9000

5 Port Solenoid Valve Base Mounted Manifold Stacking Type/Individual Wiring

Note) AC-type models that are CE-compliant have DIN terminals only.



Directional Control Valves

How to Order Manifold



- Clean series**
- Manifold series**
9 10-SY9000
- Valve stations**

Symbol	Stations
02	2 stations
:	:
20	20 stations

* Includes the number of blanking plate assemblies.
- P, R port outlets**

Symbol	Port outlet	Applicable stations
U	U side	2 to 10 stations
D	D side	
B	Both sides	2 to 20 stations
- SUP/EXH block assembly**

Symbol	Specifications
Nil	Standard/Internal pilot
R	External pilot

Thread type

Nil	Rc
F	G
N	NPT
T	NPTF

* When One-touch fittings are selected for "A, B port size", the symbol is nil.

Option

Symbol	Mounting
Nil	Direct mounting
D	DIN rail mounting (with DIN rail)
DO	DIN rail mounting (without DIN rail)
D*	When a longer DIN rail is desired than the specified stations, specify the station number to be required in place of the * mark.

A, B port size

Symbol	Port size
02	1/4
03	3/8

One-touch fitting (Metric size)

Symbol	Port size
C8	ø8 One-touch fitting
C10	ø10 One-touch fitting
C12	ø12 One-touch fitting
M	Mixed

One-touch fitting (Inch size)

Symbol	Port size
N9	ø5/16" One-touch fitting
N11	ø3/8" One-touch fitting
M	Mixed

* For mixed specifications (M), indicate separately on the manifold specification sheet.

CE-compliant

Nil	—
Q	CE-compliant

Note) AC-type models that are CE-compliant have DIN terminals only.

How to Order Manifold Assembly (Example)

Example

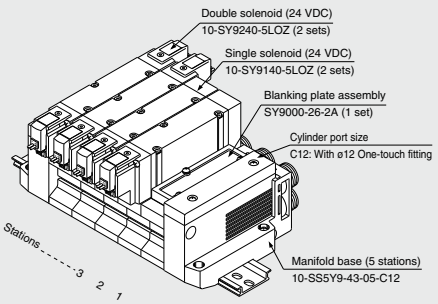

10-SS5Y9-43-05B-C12 ... 1 set (Type 43, 5-station manifold base part no.)
 * **SY9000-26-2A ... 1 set** (Blanking plate assembly part no.)
 * **10-SY9140-5LOZ ... 2 sets** (Single solenoid part no.)
 * **10-SY9240-5LOZ ... 2 sets** (Double solenoid part no.)

The asterisk denotes the symbol for assembly. Prefix it to the part no. of the solenoid valve, etc.

Add the valve and option part number under the manifold base part number. For complex arrangements, specify them on the manifold specification sheet.

Air Cylinders

Rotary Actuators

Air Grippers

Air Preparation Equipment

Modular F. R.

Pressure Control Equipment

Fittings & Tubing

Flow Control Equipment

Pressure Switches/ Pressure Sensors

How to Order Valve

Note) AC-type models that are CE-compliant have DIN terminals only.

10-SY9 **2** **40** **5** **L**

• Clean series

• Series

9	10-SY9000
---	-----------

• Actuation type

1	2 position single
2	2 position double
3	3 position closed center
4	3 position exhaust center
5	3 position pressure center

• Pilot type

Nil	Internal pilot
R	External pilot

• Coil type

Nil	Standard
T	With power saving circuit (24, 12 VDC only)

* Power saving circuit is not available for D, Y, DO, YO or W□ types.

• Rated voltage

For DC

5	24 VDC
6	12 VDC
V	6 VDC
S	5 VDC
R	3 VDC

For AC (50/60 Hz)

1	100 VAC
2	200 VAC
3	110 VAC [115 VAC]
4	220 VAC [230 VAC]

* DC specifications of type D, Y, DO and YO are only available with 12 and 24 VDC.
* For type W□, only DC voltage is available.

Note) AC-type models that are CE-compliant have DIN terminals only.

• CE-compliant

Nil	—
Q	CE-compliant

Note) AC-type models that are CE-compliant have DIN terminals only.

• Made to Order

Nil	—
X90	Main valve fluororubber (Refer to page 169.)

• Manual override

Nil	Non-locking push type
D	Push-turn locking slotted type
E	Push-turn locking lever type

• Light/Surge voltage suppressor

Electrical entry for G, H, L, M, W

Nil	Without light/surge voltage suppressor
S	With surge voltage suppressor
Z	With indicator light and surge voltage suppressor
R	With surge voltage suppressor (Non-polar type)
U	With light/surge voltage suppressor (Non-polar type)

* For AC voltage valves there is no "S" option. It is already built into the rectifier circuit.
* For "R" and "U", only DC voltage is available.
* Power saving circuit is only available for the "Z" type.

Electrical entry for D, Y

Nil	Without light/surge voltage suppressor
S	With surge voltage suppressor (Non-polar type)
Z	With light/surge voltage suppressor (Non-polar type)

* DOZ and YOZ are not available.
* For AC voltage valves there is no "S" option. It is already built into the rectifier circuit.

• Electrical entry

		24, 12, 6, 5, 3 VDC/ 100, 110, 200, 220 VAC			24, 12 VDC/ 100, 110, 200, 220 VAC	24, 12, 6, 5, 3 VDC	
		Grommet	L plug connector	M plug connector	DIN terminal	M8 connector	
G:	Lead wire length 300 mm	L:	With lead wire (Length 300 mm)	M:	With lead wire (Length 300 mm)	D:	With connector cable
H:	Lead wire length 600 mm	LN:	Without lead wire	MN:	Without lead wire	DO:	Without connector
		LO:	Without connector	MO:	Without connector	Y:	With connector cable
						YO:	Without connector
						W□:	Without connector cable (Note)
						W□:	With connector cable (Note)
CE-compliant	DC	●	●	●	●	●	●
	AC	—	—	—	●	—	—

Note) When ordering a single unit of the base mounted type solenoid valve, the mounting screws and gasket for the manifold are included.

- * LN, MN type: With 2 sockets.
 - * DIN terminal type "Y" which conforms to EN-175301-803C (former DIN43650C) is also available. For details, refer to page 173.
 - * For connector cable of M8 connector, refer to page 176.
 - * M8 connector conforming to IEC60947-5-2 standard is also available. Refer to page 168 for details.
 - * Refer to page 173 for the lead wire length of L and M plug connectors.
 - * Refer to page 174 for the connector assembly with cover for L and M plug connectors.
- Note) Enter the cable length symbols in □. Please be sure to fill in the blank referring to page 176.

Manifold Specifications

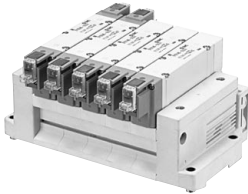

Model		10-SS5Y9-43(-Q)	
Applicable valve		10-SY9□40	
Manifold type		Stacking type	
P (SUP)/R (EXH)		Common SUP, Common EXH	
Valve stations		2 to 20 stations ^{Note 1)}	
A, B port	Location	Base	
Porting specifications		Side	
Port size	P, EA, EB port	C12 (ø12 One-touch fitting)	
	A, B port	$\frac{1}{4}$ $\frac{3}{8}$ C8 (ø8 One-touch fitting) C10 (ø10 One-touch fitting) C12 (ø12 One-touch fitting)	
Manifold base weight		W = 107n + 330	
W (g), n: Stations			

Note 1) For more than 10 stations, supply pressure to P port on both sides and exhaust from EA/EB port on both sides.

Note 2) Refer to "Manifold Option" on page 148.

Flow Rate Characteristics

Model	Port size		Flow rate characteristics					
	1, 5, 3 (P, EA, EB)	4, 2 (A, B)	1→4/2 (P→A/B)			4/2→5/3 (A/B→EA/EB)		
	C (dm ³ /s/bar)	b	Cv	C (dm ³ /s/bar)	b	Cv		
10-SS5Y9-43(-Q)	C12	C12	6.4	0.29	1.6	7.3	0.29	1.8

Note) The values are for individually operated 2 position type manifold bases with 5 stations.

Directional Control Valves

Air Cylinders

Rotary Actuators

Air Grippers

Air Preparation Equipment

Modular F. R.

Pressure Control Equipment

Fittings & Tubing

Flow Control Equipment

Pressure Switches/ Pressure Sensors

10-SY9000: 10-SS5Y9-43- Stations ^{C8, N9} _{C10, N11} **(-D)**

[] : AC

Grommet (G)

* When P, R port outlets are indicated on the D side, the P, R ports on the opposite side are plugged.

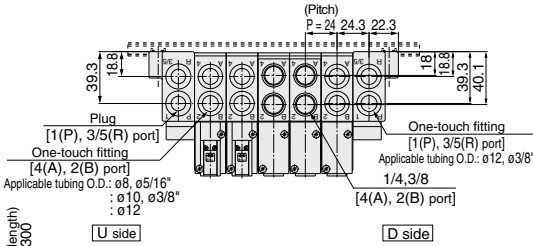

With External Pilot Specifications

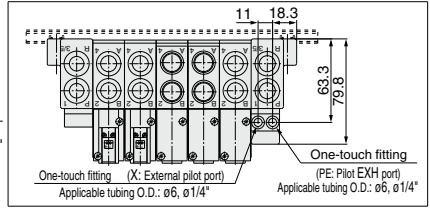

* The air discharge port for built-in silencers and the external pilot's entry position are on the D side.

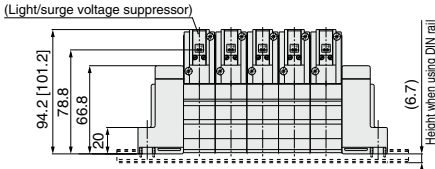
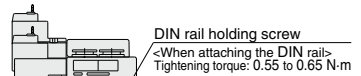
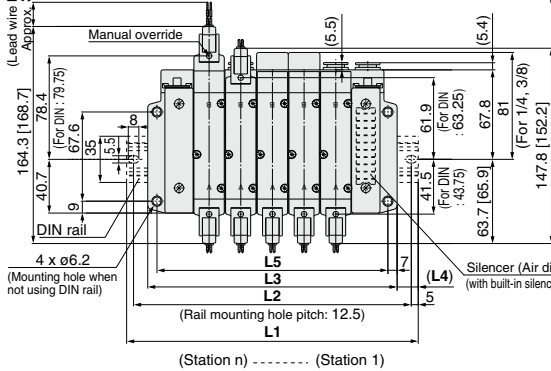

Stations	2 stations	3	4	5	6	7	8	9	10 stations
L1	148	173	198	223	248	260.5	285.5	310.5	335.5
L2	137.5	162.5	187.5	212.5	237.5	250	275	300	325
L3	117	141	165	189	213	237	261	285	309
L4	15.5	16	16.5	17	17.5	12	12.5	13	13.5
L5	103	127	151	175	199	223	247	271	295

L plug connector (L)

M plug connector (M)

DIN terminal (D, Y)

M8 connector (WO)

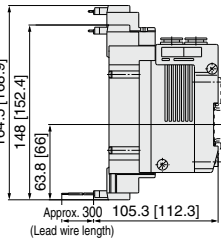
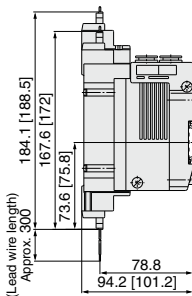

Applicable cable O.D. ø3.5 to ø7

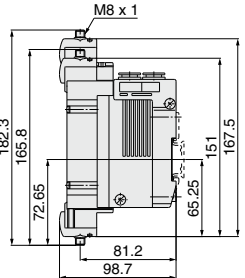
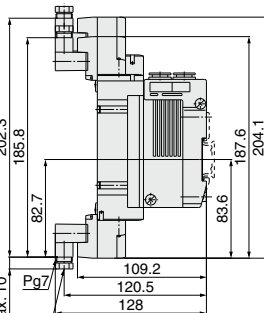

Note) Refer to page 176 for dimensions of connector types.

10-SY9000: 10-SS5Y9-43- Stations U ⁰²₀₃ ^{C9, N9}_{C10, N11} **(-D)**

[] : AC

Grommet (G)

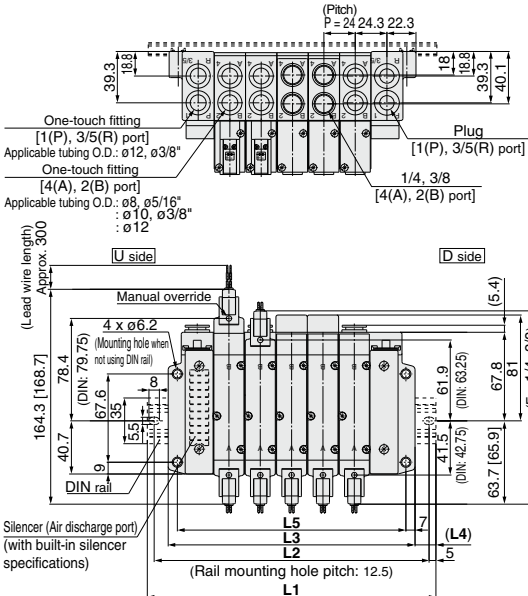

* When P, R port outlets are indicated on the U side, the P, R ports on the opposite side are plugged.

With External Pilot Specifications

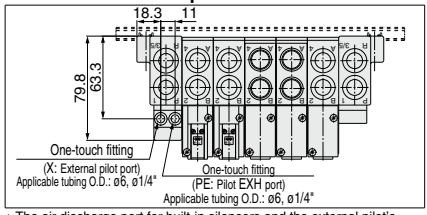

* The air discharge port for built-in silencers and the external pilot's entry position are on the D side.

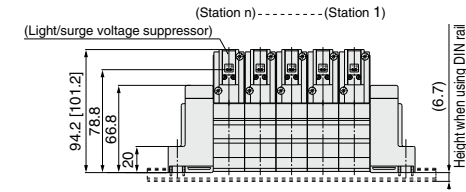
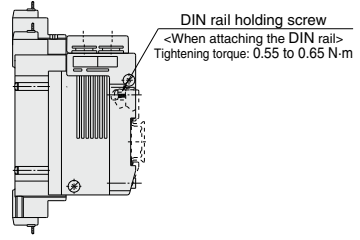

Stations	2 stations	3	4	5	6	7	8	9	10 stations
L1	148	173	198	223	248	260.5	285.5	310.5	335.5
L2	137.5	162.5	187.5	212.5	237.5	250	275	300	325
L3	117	141	165	189	213	237	261	285	309
L4	15.5	16	16.5	17	17.5	12	12.5	13	13.5
L5	103	127	151	175	199	223	247	271	295

L plug connector (L)

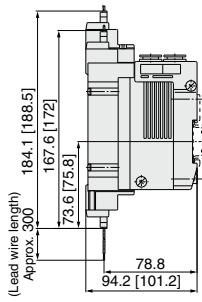

M plug connector (M)

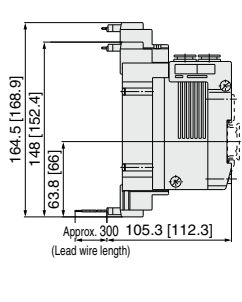

DIN terminal (D, Y)

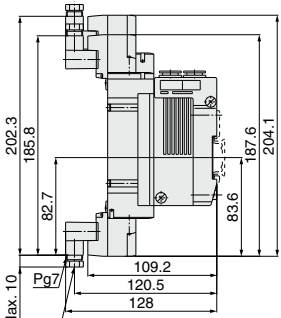

M8 connector (WO)

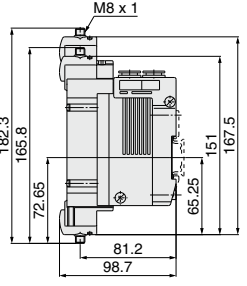

Note) Refer to page 176 for dimensions of connector types.

Directional Control Valves

Air Cylinders

Rotary Actuators

Air Grippers

Air Preparation Equipment

Modular F. R.

Pressure Control Equipment

Fittings & Tubing

Flow Control Equipment

Pressure Switches/ Pressure Sensors

10-SY9000: 10-SS5Y9-43- Stations ⁰² ₀₃ ^{C8, N9} _{C10, N11} **(-D)**

[]: AC

Grommet (G)

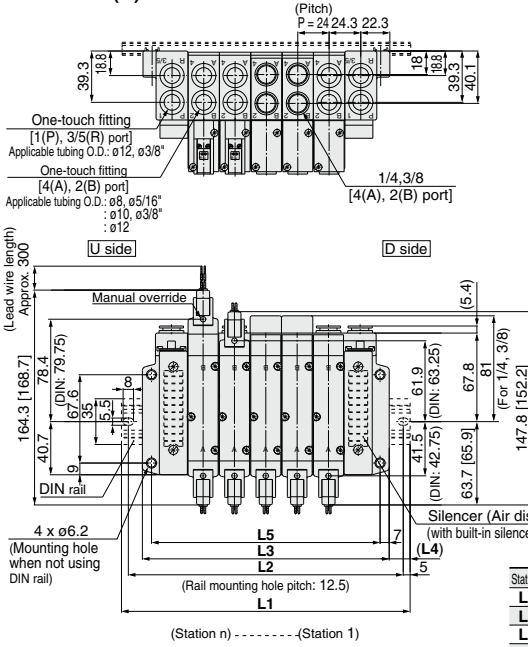

When P, R port outlets are indicated on the B side, the P, R ports on the both sides are in the open state.

With External Pilot Specifications

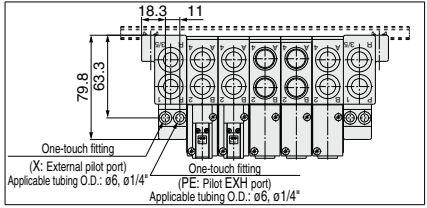

The Air discharge port for built-in silencers and the external pilot's entry position are on the B side (both sides).

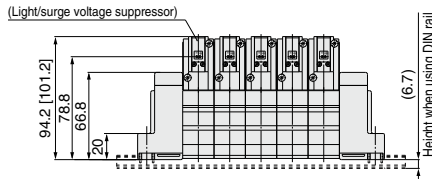
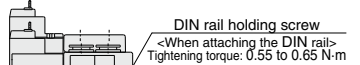

Stations	2 stations	3	4	5	6	7	8	9	10 stations
L1	148	173	198	223	248	260.5	285.5	310.5	335.5
L2	137.5	162.5	187.5	212.5	237.5	250	275	300	325
L3	117	141	165	189	213	237	261	285	309
L4	15.5	16	16.5	17	17.5	12	12.5	13	13.5
L5	103	127	151	175	199	223	247	271	295

Stations	11 stations	12	13	14	15	16	17	18	19	20 stations
L1	360.5	385.5	410.5	435.5	460.5	485.5	510.5	535.5	560.5	573
L2	350	375	400	425	450	475	500	525	550	562.5
L3	333	357	381	405	429	453	477	501	525	549
L4	14	14.5	15	15.5	16	16.5	17	17.5	18	12
L5	319	343	367	391	415	439	463	487	511	535

L plug connector (L)

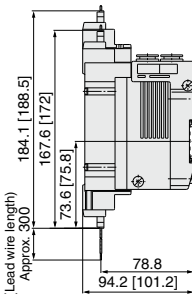

M plug connector (M)

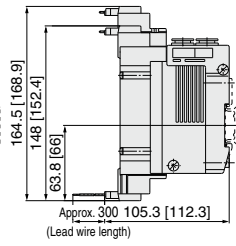

DIN terminal (D, Y)

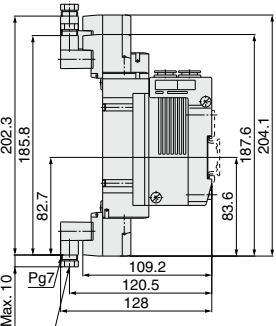

M8 connector (WO)

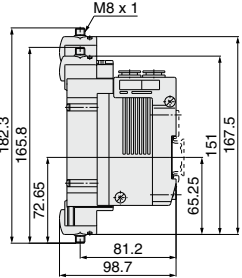

Note) Refer to page 176 for dimensions of connector types.



Note) CE-compliant:
For DC only. [Option]

Directional Control Valves

How to Order Manifold

Type 41P/Compact type

10 - SS5Y 5 - 41P - 05 - C8

Clean series

Manifold series

Stations	
03	3 stations
:	:
12	12 stations

- * 10-SS5Y3 has 4 to 12 stations.
- * Includes the number of blanking plate assemblies.

A, B port size
Thread piping

Symbol	Port size	Applicable series
M5	M5 x 0.8	10-SY3000
O1	1/8	10-SY5000

Thread type

Nil	Rc	CE-compliant
F	G	Nil
N	NPT	Q
T	NPTF	Q

Note) CE-compliant:
For DC only.

One-touch fitting (Metric size)

Symbol	Port size	Applicable series
C4	ø4 One-touch fitting	10-SY3000
C6	ø6 One-touch fitting	10-SY3000
C6	ø6 One-touch fitting	10-SY5000
C8	ø8 One-touch fitting	10-SY5000

One-touch fitting (Inch size)

Symbol	Port size	Applicable series
N3	ø5/32 One-touch fitting	10-SY3000
N7	ø1/4" One-touch fitting	10-SY3000
N7	ø1/4" One-touch fitting	10-SY5000
N9	ø3/8 One-touch fitting	10-SY5000

Type 42P/Common external pilot

10 - SS5Y 5 - 42P - 05 - C8

Clean series

Manifold series

Stations	
03	3 stations
:	:
12	12 stations

- * 10-SS5Y3 has 4 to 12 stations.
- * Includes the number of blanking plate assemblies.

A, B port size
Thread piping

Symbol	Port size	Applicable series
O1	1/8	10-SY3000
O2	1/4	10-SY5000
O2	1/4	10-SY7000

Thread type

Nil	Rc	CE-compliant
F	G	Nil
N	NPT	Q
T	NPTF	Q

Note) CE-compliant:
For DC only.

One-touch fitting (Metric size)

Symbol	Port size	Applicable series
C4	ø4 One-touch fitting	10-SY3000
C6	ø6 One-touch fitting	10-SY3000
C6	ø6 One-touch fitting	10-SY5000
C8	ø8 One-touch fitting	10-SY5000
C10	ø10 One-touch fitting	10-SY7000

One-touch fitting (Inch size)

Symbol	Port size	Applicable series
N3	ø5/32 One-touch fitting	10-SY3000
N7	ø1/4" One-touch fitting	10-SY3000
N7	ø1/4" One-touch fitting	10-SY5000
N9	ø3/8 One-touch fitting	10-SY5000
N11	ø3/8 One-touch fitting	10-SY7000

How to Order Manifold Assembly (Example)

Example

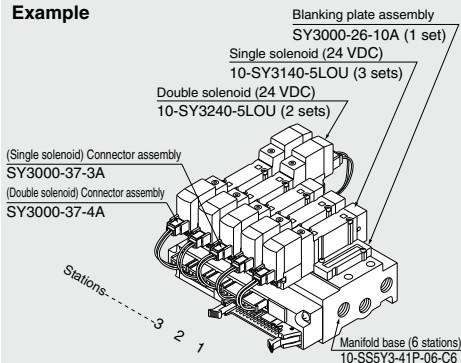

- 10-SS5Y3-41P-06-C6 ... 1 set (Type 41P, 6-station manifold base part no.)
 * SY3000-26-10A 1 set (Blanking plate assembly part no.)
 * 10-SY3140-5LOU 3 sets (Single solenoid part no.)
 * 10-SY3240-5LOU 2 sets (Double solenoid part no.)
 * SY3000-37-3A 3 sets (Connector assembly part no.)
 * SY3000-37-4A 2 sets (Connector assembly part no.)

The asterisk denotes the symbol for assembly.
Prefix it to the part no. of the solenoid valve, etc.

Add the valve and option part number under the manifold base part number. For complex arrangements, specify them on the manifold specification sheet.

Note) Please indicate the connector assembly part no. (page 135) that connects the valve and the manifold.

Air Cylinders

Rotary Actuators

Air Grippers

Air Preparation Equipment

Modular F. R.

Pressure Control Equipment

Fittings & Tubing

Flow Control Equipment

Pressure Switches/ Pressure Sensors

How to Order Valve

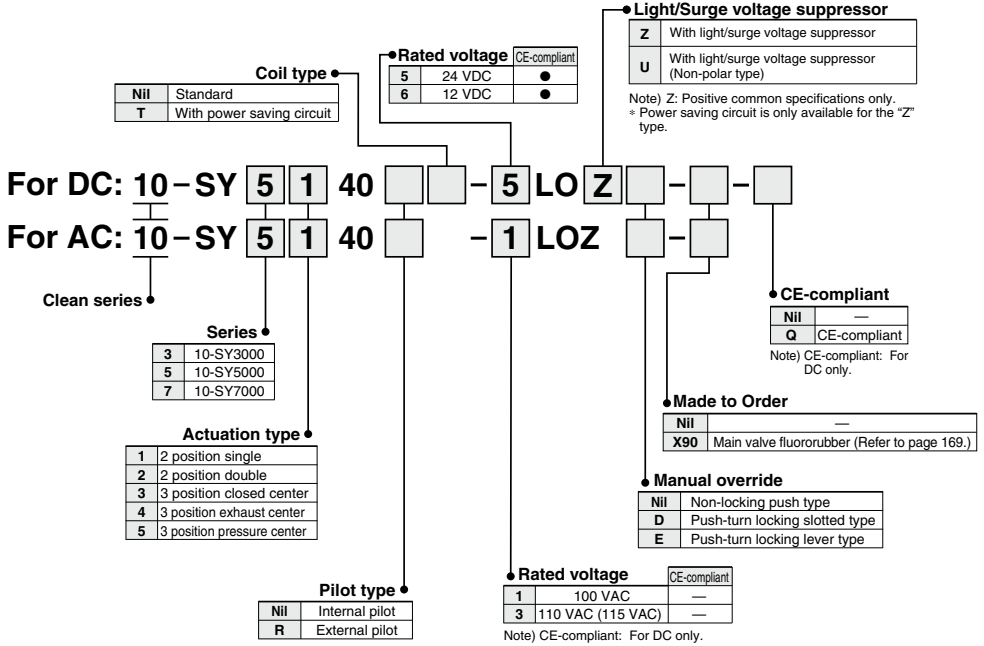

Note) When ordering single a unit of the base mounted type solenoid valve, the mounting screws and gasket for the manifold are included.

Note) For flat ribbon cables, "U" and "Z" types are for DC specifications and "Z" type is for AC specifications. "Z" type for DC is positive common specification only. For other combinations, please contact SMC.

Note) Since the electrical entry is "LO", select an appropriate connector assembly part no.

Connector Assembly

For 12, 24 VDC

Specifications	For 10-SY3000	For 10-SY5000/7000
For single solenoid	SY3000-37-3A	SY5000-37-3A
Double solenoid, 3 position type	SY3000-37-4A	SY5000-37-4A
Single with spacer assembly	SY5000-37-3A	SY5000-37-5A
Double, 3 position with spacer assembly	SY3000-37-6A	SY5000-37-6A

Note) Spacer assembly indicates individual SUP/EXH spacer.

For 100 VAC

Specifications	For 10-SY3000	For 10-SY5000/7000
For single solenoid	SY3000-37-32A	SY5000-37-15A
Double solenoid, 3 position type	SY3000-37-33A	SY5000-37-16A
Single with spacer assembly	SY5000-37-15A	SY5000-37-17A
Double, 3 position with spacer assembly	SY3000-37-34A	SY5000-37-18A

For 110 VAC (115 VAC)

Specifications	For 10-SY3000	For 10-SY5000/7000
For single solenoid	SY3000-37-35A	SY5000-37-19A
Double solenoid, 3 position type	SY3000-37-36A	SY5000-37-20A
Single with spacer assembly	SY5000-37-19A	SY5000-37-21A
Double, 3 position with spacer assembly	SY3000-37-37A	SY5000-37-22A

Flat Ribbon Cable Manifold Specifications

- Multiple valve wiring is simplified through the use of the flat ribbon cable connector.

• Clean appearance

For flat ribbon cables, each valve is wired on the print board of the manifold base to allow the external wiring to be piped all together with the 26 pin MIL connector.

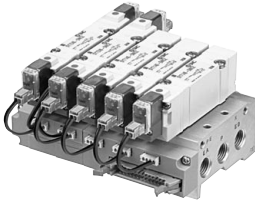

Model	10-SSY3-41P(-Q)		10-SSY3-42P(-Q)		10-SSY5-41P(-Q)		10-SSY5-42P(-Q)		10-SSY7-42P(-Q)	
Applicable valve	10-SY3□40		10-SY5□40		10-SY5□40		10-SY7□40			
Manifold type	Single base/B mount									
P (SUP/R (EXH))	Common SUP, Common EXH									
Valve stations	4 to 12 stations ^{Note 1)}					3 to 12 stations ^{Note 1)}				
A, B port	Base									
	Side									
Port size	P, EA, EB port		1/8		1/8		1/4		1/4	
	A, B port		C4 (ø4 One-touch fitting) C6 (ø6 One-touch fitting)		C4 (ø4 One-touch fitting) C6 (ø6 One-touch fitting)		C6 (ø6 One-touch fitting) C8 (ø8 One-touch fitting)		C6 (ø6 One-touch fitting) C8 (ø8 One-touch fitting)	
Manifold base weight W (g), n: Stations	W = 39n + 83		W = 48n + 99		W = 67n + 118		W = 88n + 151		W = 109n + 174	
Applicable flat ribbon cable connector	Flat ribbon cable connector, Socket: 26 pin MIL type with strain relief, Conforming to MIL-C-83503									
Internal wiring	Common between +COM and -COM (Z type: +COM only).									
Rated voltage ^{Note 4)}	12, 24 VDC, 100, 110 VAC									

Note 1) For more than 10 stations (more than 5 stations in case of 10-SSY7), supply pressure to P port on both sides and exhaust from EA/EB port on both sides.

Note 2) The withstand voltage specification for the wiring unit section is JIS C 0704, Grade 1 or its equivalent.

Note 3) Refer to "Manifold Option" on page 148.

Note 4) CE-compliant: For DC only.

Flow Rate Characteristics

Model	Port size		Flow rate characteristics					
	1, 5, 3 (P, EA, EB)	4, 2 (A, B)	1 → 4/2 (P → A/B)			4/2 → 5/3 (A/B → EA/EB)		
			C (dm ³ /(s·bar))	b	Cv	C (dm ³ /(s·bar))	b	Cv
10-SSY3-41P	1/8	C6	0.75	0.19	0.18	0.81	0.23	0.20
10-SSY3-42P	1/8	C6	0.75	0.20	0.18	0.82	0.20	0.20
10-SSY5-41P	1/4	C8	1.8	0.23	0.44	1.9	0.16	0.45
10-SSY5-42P	1/4	C8	1.9	0.20	0.46	1.9	0.12	0.43
10-SSY7-42P	1/4	C10	3.0	0.25	0.75	3.0	0.12	0.66

Note) The values are for individually operated 2 position type manifold bases with 5 stations.

Internal Wiring of Manifold

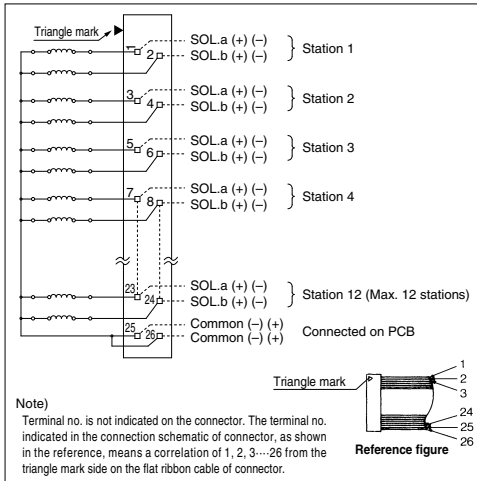

- For more than 10 stations, both poles of the common should be wired.
- For single solenoid, connect to the solenoid A side.
- The maximum number of stations that can be accommodated is 12. For more stations, please contact SMC.

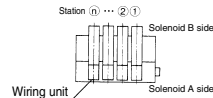

⚠ Caution

- For non-polar "U" valves, the electrical DC connections can be used with either positive and negative COM. For type "Z", only use with positive COM as the valve does not operate correctly when used with negative COM.

10-SY3000: 10-SS5Y3-41P- Stations -M5, C4, N3, C6, N7

[] : AC

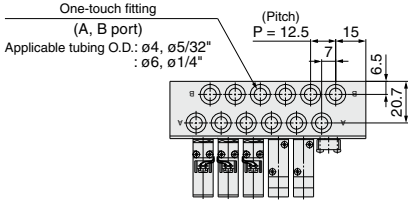

For M5 x 0.8

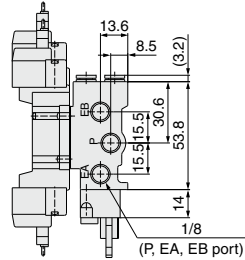
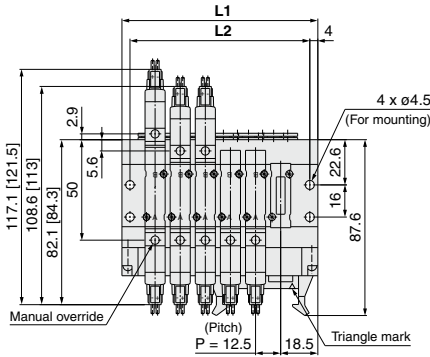
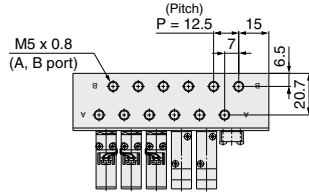

(Station n) ----- (Station 1)

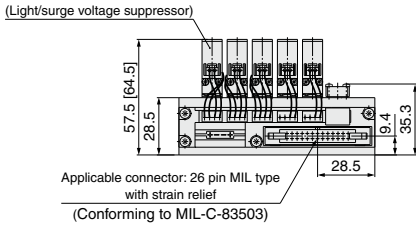

Stations	4	5	6	7	8	9	10	11	12
L1	72.5	85	97.5	110	122.5	135	147.5	160	172.5
L2	64.5	77	89.5	102	114.5	127	139.5	152	164.5

10-SY5000: 10-SS5Y5-41P-Stations -01, C6, N7
C8, N9

[] : AC

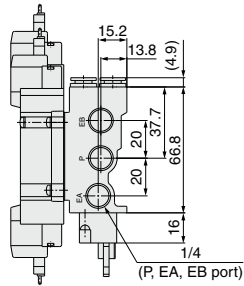
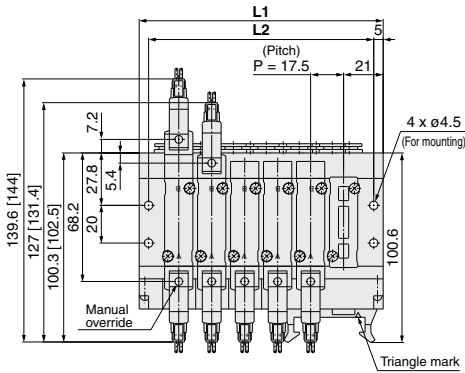
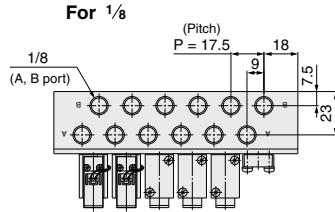
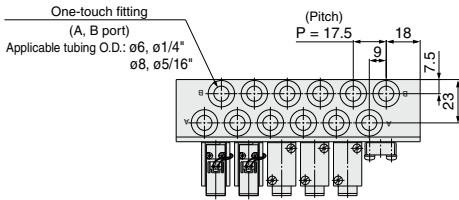

(Station n) ----- (Station 1)

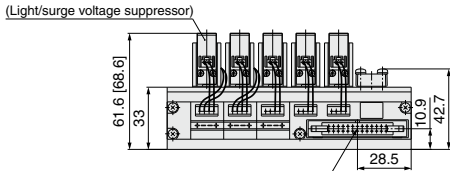

Applicable connector: 26 pin MIL type
with strain relief
(Conforming to MIL-C-83503)

Stations	3	4	5	6	7	8	9	10	11	12
L1	77	94.5	112	129.5	147	164.5	182	199.5	217	234.5
L2	67	84.5	102	119.5	137	154.5	172	189.5	207	224.5

Directional
Control Valves

Air Cylinders

Rotary Actuators

Air Grippers

Air Preparation
Equipment

Modular F. R.

Pressure Control
Equipment

Fittings & Tubing

Flow Control
Equipment

Pressure Switches/
Pressure Sensors

10-SY3000: 10-SS5Y3-42P- Stations -01, C4, N3
C6, N7

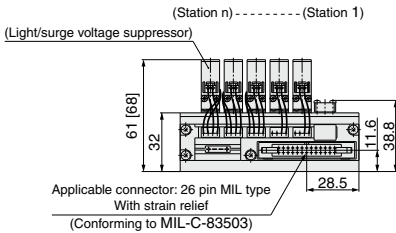
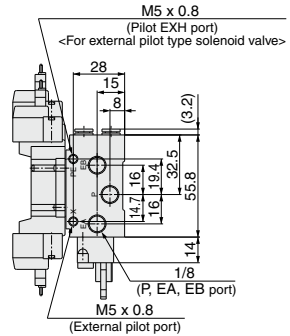
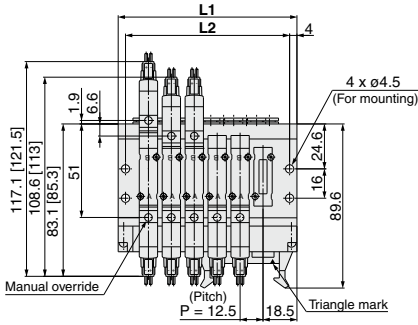
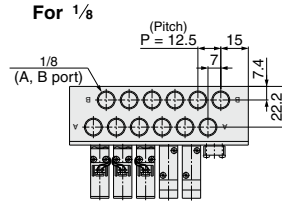
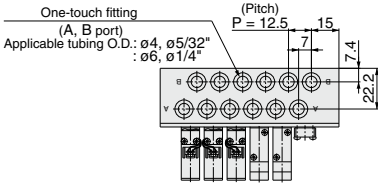

Stations	4	5	6	7	8	9	10	11	12
L1	72.5	85	97.5	110	122.5	135	147.5	160	172.5
L2	64.5	77	89.5	102	114.5	127	139.5	152	164.5

10-SY5000: 10-SS5Y5-42P- Stations -02, C6, N7
C8, N9

[] : AC

Grommet (G)

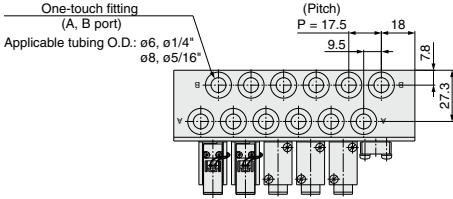

For 1/4

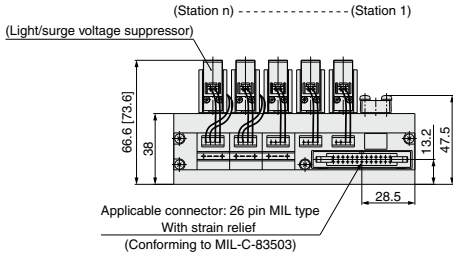
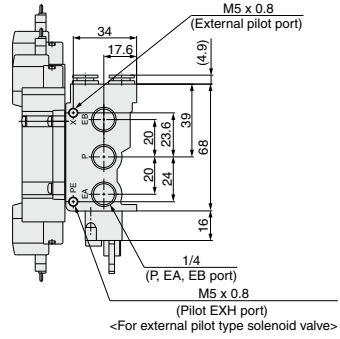
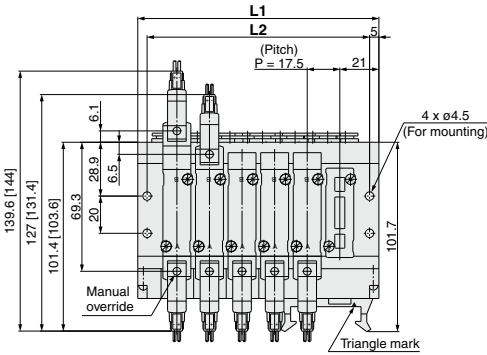
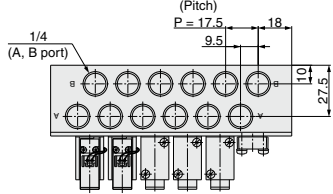

Stations	3	4	5	6	7	8	9	10	11	12
L1	77	94.5	112	129.5	147	164.5	182	199.5	217	234.5
L2	67	84.5	102	119.5	137	154.5	172	189.5	207	224.5

Directional Control Valves
Air Cylinders
Rotary Actuators
Air Grippers
Air Preparation Equipment
Modular F. R.
Pressure Control Equipment
Fittings & Tubing
Flow Control Equipment
Pressure Switches/ Pressure Sensors

10-SY7000: 10-SS5Y7-42P- Stations -02, C10, N11

[]: AC

Grommet (G)

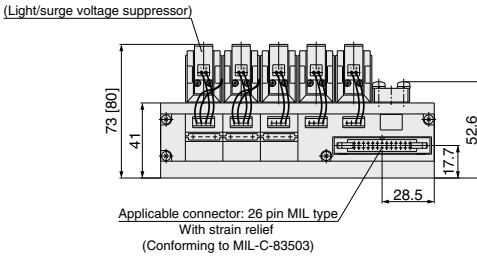
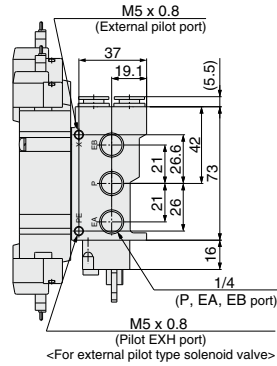
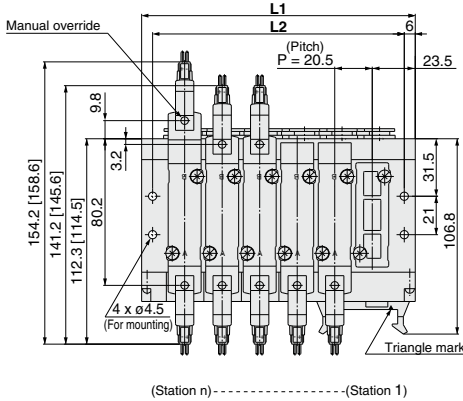
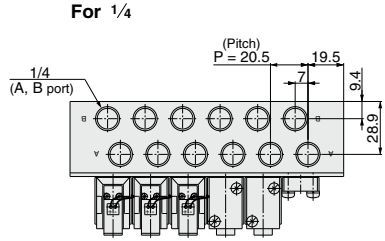
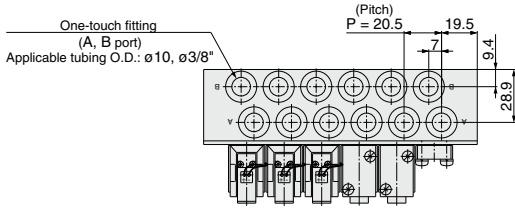

Stations	3	4	5	6	7	8	9	10	11	12
L1	88	108.5	129	149.5	170	190.5	211	231.5	252	272.5
L2	76	96.5	117	137.5	158	178.5	199	219.5	240	260.5

Type 43P Series 10-SY9000

5 Port Solenoid Valve Base Mounted Manifold Stacking Type/Flat Ribbon Cable

Note) CE-compliant:
For DC only. [Option]



Directional Control Valves

How to Order Manifold

10-SS5Y9-43P-05 U - C8 - - -

• Clean series

• Manifold series
9 10-SY9000

• Valve stations

Symbol	Stations
04	4 stations
:	:
12	12 stations

* Includes the number of blanking plate assemblies.

• P, R port outlets

Symbol	Port outlet	Applicable stations
U	U side	4 to 10 stations
D	D side	4 to 10 stations
B	Both sides	4 to 12 stations

• SUP/EXH block assembly specifications

Symbol	Specifications
NII	Standard/Internal pilot specification
R	External pilot specification

• Thread type

Nil	Rc
F	G
N	NPT
T	NPTF

• Option

Symbol	Mounting
NII	Direct mounting
D	DIN rail mounting (with DIN rail)
D0	DIN rail mounting (without DIN rail)
D*	When a longer DIN rail is desired than the specified stations, specify the station number to be required into * mark.

• A, B port size

Thread piping	Port size
02	1/4
03	3/8

• One-touch fitting (Metric size)

Symbol	Port size
C8	ø8 One-touch fitting
C10	ø10 One-touch fitting
C12	ø12 One-touch fitting
M	Mixed

• One-touch fitting (Inch size)

Symbol	Port size
N9	ø5/16" One-touch fitting
N11	ø3/8" One-touch fitting
M	Mixed

* For mixed specifications (M), indicate separately on the manifold specification sheet.

• CE-compliant

NII	-
Q	CE-compliant

Note) CE-compliant: For DC only.

How to Order Manifold Assembly (Example)

Example

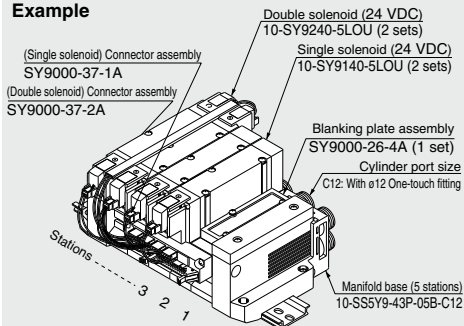

- 10-SS5Y9-43P-05B-C12... 1 set (Type 43P, 5-station manifold base part no.)
 * SY9000-26-4A 1 set (Blanking plate assembly part no.)
 * 10-SY9140-5LOU 2 sets (Single solenoid part no.)
 * 10-SY9240-5LOU 2 sets (Double solenoid part no.)
 * SY9000-37-1A 2 sets (Connector assembly part no.)
 * SY9000-37-2A 2 sets (Connector assembly part no.)

The asterisk denotes the symbol for assembly. Prefix it to the part no. of the solenoid valve, etc.

Add the valve and option part number under the manifold base part number. For complex arrangements, specify them on the manifold specification sheet.

Note) Please indicate the connector assembly part no. (page 143) that connects the valve and the manifold.

Air Cylinders

Rotary Actuators

Air Grippers

Air Preparation Equipment

Modular F. R.

Pressure Control Equipment

Fittings & Tubing

Flow Control Equipment

Pressure Switches/ Pressure Sensors

How to Order Valve

Note) CE-compliant:
For DC only.

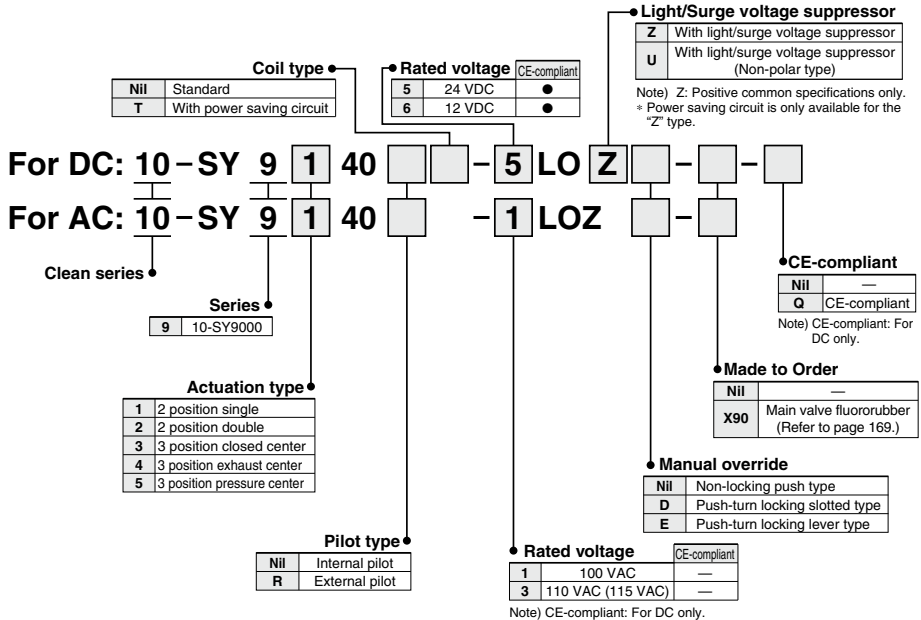

Note) When ordering a single unit of the base mounted type solenoid valve, the mounting screws and gasket for the manifold are included.

Note) For flat ribbon cables, "U" and "Z" types are for DC specifications and "Z" type is for AC specifications. "Z" type for DC is positive common specification only.
For other combinations, please contact SMC.

Note) Since the electrical entry is "LO", select an appropriate connector assembly part no.

Connector Assembly

For 12, 24 VDC

Specifications	For 10-SY9000
For single solenoid	SY9000-37-1A
Double solenoid, 3 position type	SY9000-37-2A
Single with spacer assembly	SY9000-37-3A
Double, 3 position with spacer assembly	SY9000-37-4A

Note) Spacer indicates individual SUP/EXH spacer.

For 100 VAC

Specifications	For 10-SY9000
For single solenoid	SY9000-37-1B
Double solenoid, 3 position type	SY9000-37-2B
Single with spacer assembly	SY9000-37-3B
Double, 3 position with spacer assembly	SY9000-37-4B

For 110 VAC (115 VAC)

Specifications	For 10-SY9000
For single solenoid	SY9000-37-1C
Double solenoid, 3 position type	SY9000-37-2C
Single with spacer assembly	SY9000-37-3C
Double, 3 position with spacer assembly	SY9000-37-4C

Flat Ribbon Cable Manifold Specifications

- **Multiple valve wiring is simplified through the use of the flat ribbon cable connector.**
- **Clean appearance**

For flat ribbon cables, each valve is wired on the print board of the manifold base to allow the external wiring to be piped all together with the 26 pin MIL connector.

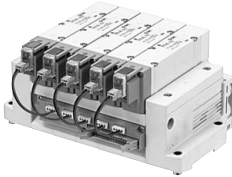

Model		10-SS5Y9-43P	
Applicable valve		10-SY9□40	
Manifold type		Stacking type	
P (SUP)/R (EXH)		Common SUP, Common EXH	
Valve stations		4 to 12 stations ^{Note 1)}	
A, B port	Location	Base	
	Direction	Side	
Porting specifications	P, EA, EB port	C12 (ø12 One-touch fitting)	
	A, B port	1/4 3/8 C8 (ø8 One-touch fitting) C10 (ø10 One-touch fitting) C12 (ø12 One-touch fitting)	
Manifold base weight W (g) n: Stations		W = 114n + 343	
Applicable flat ribbon cable connector		Flat ribbon cable connector, Socket: 26 pin MIL type with strain relief, Conforming to MIL-C-83503	
Internal wiring		Common between +COM and -COM (Z type: +COM only)	
Rated voltage ^{Note 4)}		12, 24 VDC, 100, 110 VAC	

- Note 1) For more than 10 stations, supply pressure to P port on both sides and exhaust from EA/EB port on both sides.
 Note 2) The withstand voltage specification for the wiring unit section is JIS C 0704, Grade 1 or its equivalent.
 Note 3) Refer to "Manifold Option" on page 148.
 Note 4) CE-compliant: For DC only.

Flow Rate Characteristics

Model	Port size		Flow rate characteristics					
	1, 5, 3 (P, EA, EB)	4, 2 (A, B)	1 → 4/2 (P → A/B)			4/2 → 5/3 (A/B → EA/EB)		
			C (dm ³ /(s·bar))	b	Cv	C (dm ³ /(s·bar))	b	Cv
10-SS5Y9-43P	C12	C12	6.4	0.29	1.6	7.3	0.29	1.8

Note) The values are for individually operated 2 position type manifold bases with 5 stations.

Internal Wiring of Manifold (Non-polar type)

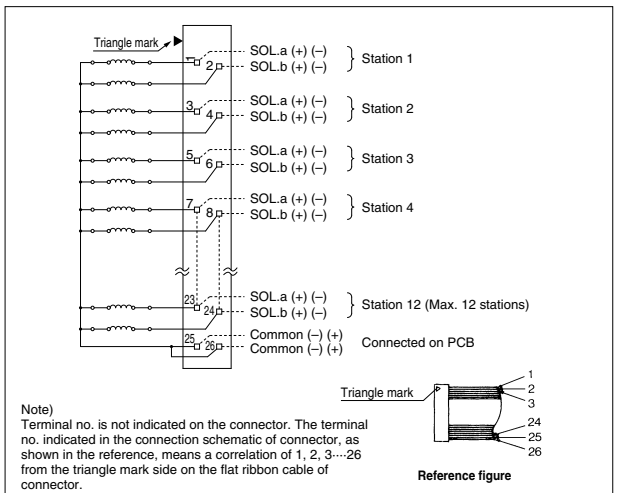

Note)
 Terminal no. is not indicated on the connector. The terminal no. indicated in the connection schematic of connector, as shown in the reference, means a correlation of 1, 2, 3...26 from the triangle mark side on the flat ribbon cable of connector.

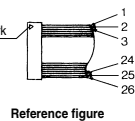

⚠ Caution

- For non-polar "U" valves, the electrical DC connections can be used with either positive and negative COM. For type "Z", only use with positive COM as the valve does not operate correctly when used with negative COM.

- For more than 10 stations, both poles of the common should be wired.
- For single solenoid, connect to the solenoid A side.
- The maximum number of stations that can be accommodated is 12. For more stations, please contact SMC.

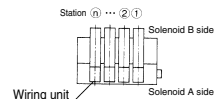

Directional Control Valves
 Air Cylinders
 Rotary Actuators
 Air Grippers
 Air Preparation Equipment
 Modular F. R.
 Pressure Control Equipment
 Fittings & Tubing
 Flow Control Equipment
 Pressure Switches/ Pressure Sensors

10-SY9000: 10-SS5Y9-43P- Stations D ^{02, C8, N9} _{03, C10, N11} **(-D)**

[] : AC

* When P, R port outlets are indicated on the D side, the P, R ports on the opposite side are plugged.

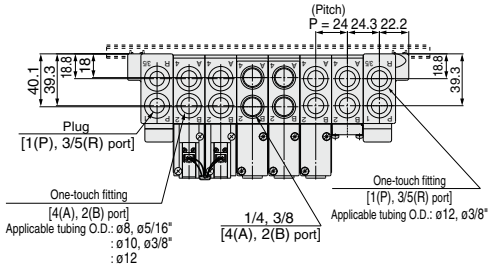

With External Pilot Specifications

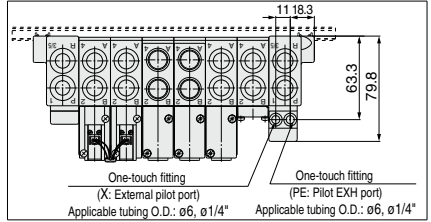

* The air discharge port for built-in silencers and the external pilot's entry position are on the D side.

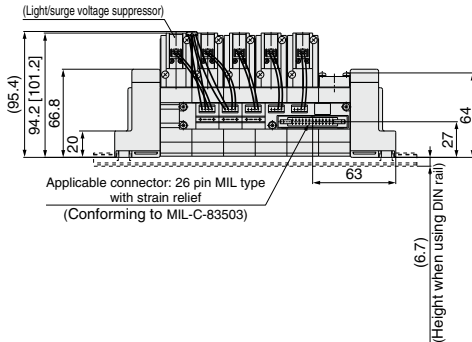
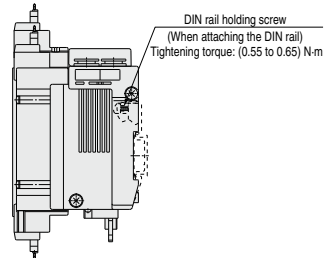
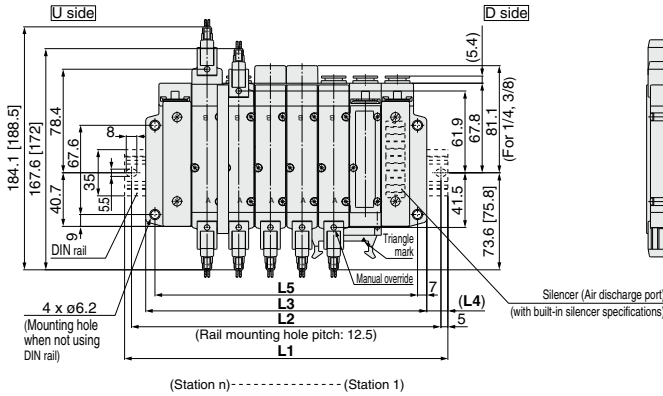

Stations	4 stations	5	6	7	8	9	10 stations
L1	198	223	248	260.5	285.5	310.5	335.5
L2	187.5	212.5	237.5	250	275	300	325
L3	165	189	213	237	261	285	309
L4	16.5	17	17.5	12	12.5	13	13.5
L5	151	175	199	223	247	271	295

10-SY9000: 10-SS5Y9-43P-Stations U -02, C8, N9
-03, C10, N11 (-D) C12

[] : AC

* When P, R port outlets are indicated on the U side, the P, R ports on the opposite side are plugged.

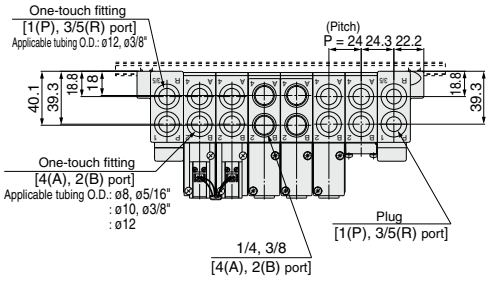

With External Pilot Specifications

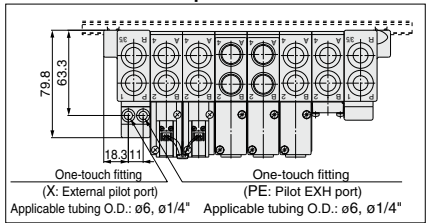

* The air discharge port for built-in silencers and the external pilot's entry position are on the U side.

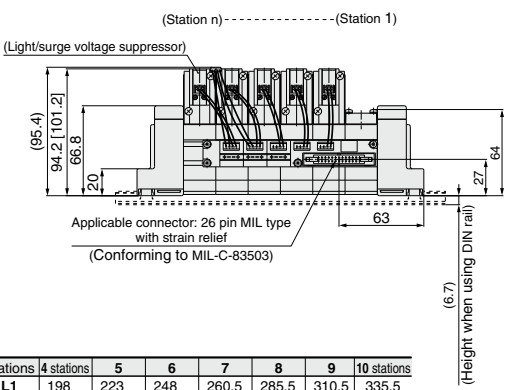
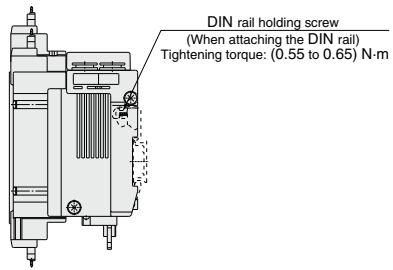
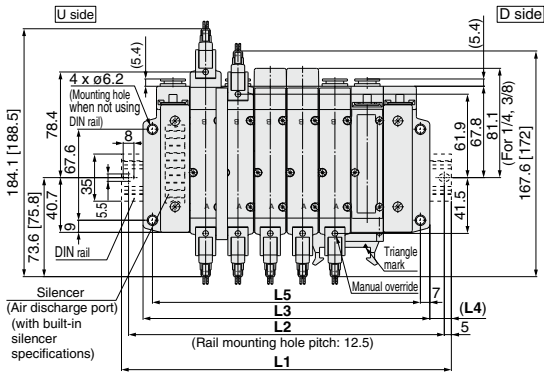

Stations	4 stations	5	6	7	8	9	10 stations
L1	198	223	248	260.5	285.5	310.5	335.5
L2	187.5	212.5	237.5	250	275	300	325
L3	165	189	213	237	261	285	309
L4	16.5	17	17.5	12	12.5	13	13.5
L5	151	175	199	223	247	271	295

Directional Control Valves
 Air Cylinders
 Rotary Actuators
 Air Grippers
 Air Preparation Equipment
 Modular F. R.
 Pressure Control Equipment
 Fittings & Tubing
 Flow Control Equipment
 Pressure Switches/ Pressure Sensors

10-SY9000: 10-SS5Y9-43P- Stations B 02, C8, N9
C10, N11
C12 **(-D)**

[] : AC

* When P, R port outlets are indicated on the B side, the P, R ports on the both sides are in the open state.

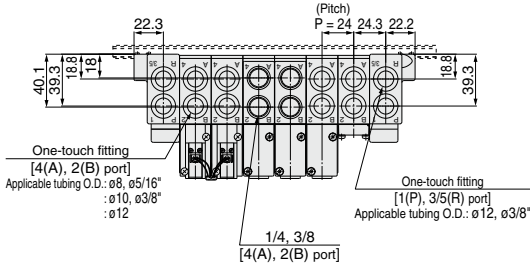

With External Pilot Specifications

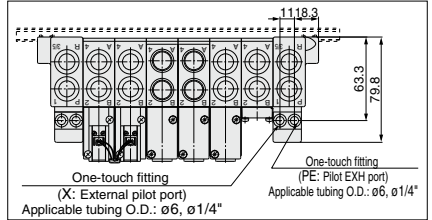

* The air discharge port for built-in silencers and the external pilot's entry position are on the B side (both sides).

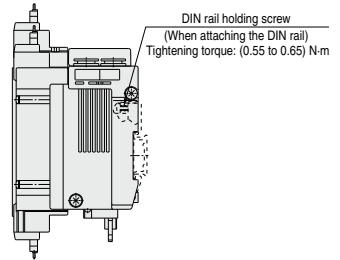
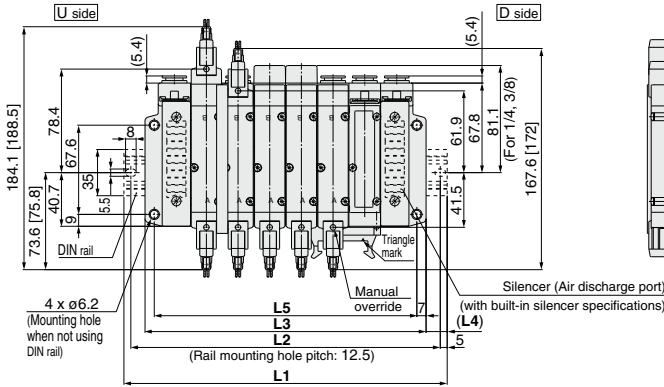

(Station n)------(Station 1)

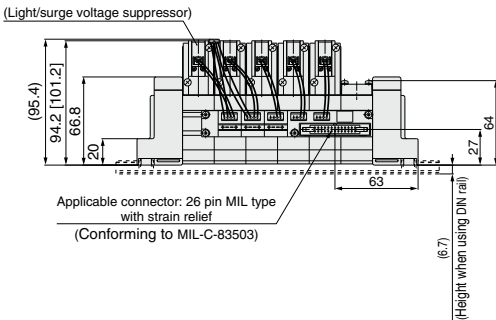

Stations	4 stations	5	6	7	8	9	10	11	12 stations
L1	198	223	248	260.5	285.5	310.5	335.5	360.5	385.5
L2	187.5	212.5	237.5	250	275	300	325	350	375
L3	165	189	213	237	261	285	309	333	357
L4	16.5	17	17.5	12	12.5	13	13.5	14	14.5
L5	151	175	199	223	247	271	295	319	343

Manifold Option

■ Type 41, 42, 43, 42SA, 43SA Blanking plate assembly

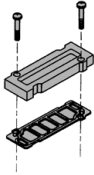

Series	Assembly part no.
10-SY3000	SY3000-26-9A(-Q)
10-SY5000	SY5000-26-20A(-Q)
10-SY7000	SY7000-26-22A(-Q)
10-SY9000	SY9000-26-2A(-Q)

■ Type 41P, 42P, 43P Blanking plate assembly

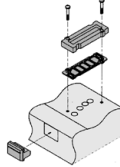

Series	Assembly part no.
10-SY3000	SY3000-26-10A(-Q)
10-SY5000	SY5000-26-21A(-Q)
10-SY7000	SY7000-26-23A(-Q)
10-SY9000	SY9000-26-4A(-Q)

■ Gasket assembly part no.

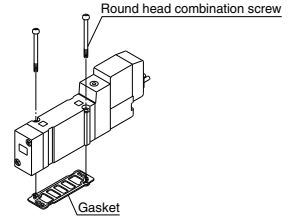

Series	Gasket assembly part no.
10-SY3000	SY3000-GS-2
10-SY5000	SY5000-GS-2(-Q)
10-SY7000	SY7000-GS-2(-Q)
10-SY9000	SY9000-GS-2

Note) The gasket assembly consists of 10 sets of mounting screws and a gasket.

■ Individual SUP spacer assembly

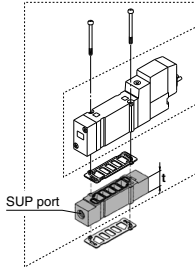

Series	Assembly part no.	Port size	t
10-SY3000	SY3000-38-2A(-Q)	M5 x 0.8	11
10-SY5000	SY5000-38-16*A(-Q)	1/8	15
10-SY7000	SY7000-38-16*A(-Q)	1/4	18
10-SY9000	SY9000-38-2*A(-Q)	1/4	20

Note) • The SUP port of 10-SY3000, 5000 and 7000 may be either on the lead wire side or on the end plate side. However, as the CE-compliant products (-Q) must be mounted in the specified direction, the port directions cannot be changed. (An assembly is shipped under the condition shown in the figure.)
• For the 10-SY9000, it can only be used on the end plate side.

■ Individual EXH spacer assembly

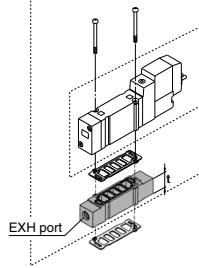

Series	Assembly part no.	Port size	t
10-SY3000	SY3000-39-2A(-Q)	M5 x 0.8	11
10-SY5000	SY5000-39-16*A(-Q)	1/8	15
10-SY7000	SY7000-39-16*A(-Q)	1/4	18
10-SY9000	SY9000-39-2*A(-Q)	1/4	20

Note) • In case of 41P, 42P and 43P, for protection of the wiring unit section from drainage, piping at the EA port should be arranged so that it will not be directly exposed to exhaust from the valve. However, as the CE-compliant products (-Q) must be mounted in the specified direction, the port directions cannot be changed. (An assembly is shipped under the condition shown in the figure.)
• For the 10-SY9000, it can only be used on the end plate side.

■ Individual SUP spacer assembly + Individual EXH spacer assembly (Double spacer)

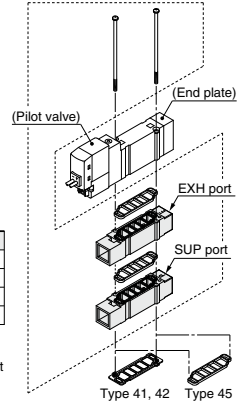

⚠ Caution * Thread type

Mounting screw tightening torques

M2: 0.16 N·m
M3: 0.8 N·m
M4: 1.4 N·m

	NII	Rc
F	N	G
N	NPT	
T	NPTF	

⚠ Warning

When mounting a valve or spacer on the manifold base or sub-plate, etc., those mounting directions are determined. If mounted in the wrong direction, the equipment to be connected may cause malfunction. Refer to external dimensions, and then mount it.

●: Available X: Not available —: Not applicable manifold]

Series	Individual SUP + Individual EXP Assembly part no.	Port size	Applicable manifold types						
			41	41P	42	42P	45	45-A 45-NA	45*
10-SY3000	SY3000-120-2A(-Q)	M5 x 0.8	●	X	●	X	●	X	X
10-SY5000	SY5000-75-1*A(-Q)	1/8	●	X	●	X	●	X	X
10-SY7000	SY7000-73-1*A(-Q)	1/4	●	X	●	X	—	—	—

Note) The port on a spacer can be directed to the pilot valve side or end plate side. However, as the CE-compliant products (-Q) must be mounted in the specified direction, the port directions cannot be changed. For mounting the port to the pilot valve side, please make sure to connect the ports to protect the pilot valve wiring section from drainage.
The individual SUP spacer and EXH spacer can be mounted either on the upper side or lower side. (The above illustration shows the condition when the product is shipped out from a factory.)

Directional Control Valves
 Air Cylinders
 Rotary Actuators
 Air Grippers
 Air Preparation Equipment
 Modular F. R.
 Pressure Control Equipment
 Fittings & Tubing
 Flow Control Equipment
 Pressure Switches/ Pressure Sensors

Manifold Option

■ SUP block disk (For 10-SY9000)

By installing a SUP block disk in the pressure supply passage of a manifold base, it is possible to supply two or more different high and low pressures to one manifold.



Series	No.
10-SY9000	SY9000-57-1A

■ EXH block disk (For 10-SY9000)

By installing an EXH block disk in the exhaust passage of a manifold base, it is possible to divide the valve's exhaust so that it does not affect another valve. (Two block disks are needed to divide both exhausts.)



Series	No.
10-SY9000	SY9000-57-1A

■ Label for block disk (For 10-SY9000)

The labels shown below are used on manifold stations containing SUP/EXH block disk(s) to show their location. (3 pcs. each)

VZ3000-123-1A

Label for SUP block disk Label for EXH block disk Label for SUP/EXH block disk

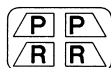
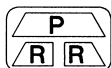

Note) When a block disk is concurrently ordered by specifying it on the manifold specification sheet, etc., a label will be attached to the position where the block disk is mounted.

■ DIN Rail Dimensions/Weight for 10-SY9000

VZ1000-11-4-□

■ Refer to L dimensions

* Enter a number from the DIN rail dimension table below.

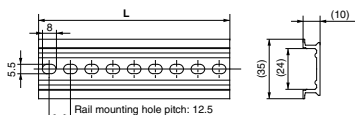

No.	0	1	2	3	4	5	6	7	8	9
L Dimension	98	110.5	123	135.5	148	160.5	173	185.5	198	210.5
Weight (g)	24.8	28	31.1	34.3	37.4	40.6	43.8	46.9	50.1	53.3
No.	10	11	12	13	14	15	16	17	18	19
L Dimension	223	235.5	248	260.5	273	285.5	298	310.5	323	335.5
Weight (g)	56.4	59.6	62.7	65.9	69.1	72.2	75.4	78.6	81.7	84.9
No.	20	21	22	23	24	25	26	27	28	29
L Dimension	348	360.5	373	385.5	398	410.5	423	435.5	448	460.5
Weight (g)	88	91.2	94.4	97.5	100.7	103.9	107	110.2	113.3	116.5

Note) • Refer to page 175 for DIN rail.
• Refer to L1 dimension on pages 131 to 133 and 145 to 147 for lengths that correspond to the number of manifold stations.

■ Cable assembly (For 41P, 42P, 43P)

AXT100-FC26-¹/₃

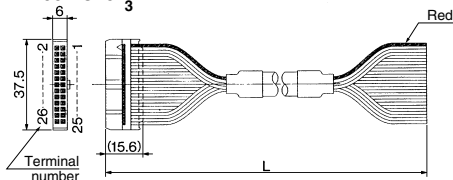

Connector Assembly for Flat Ribbon Cables

Cable length (L)	Assembly part no.	Note
1.5 m	AXT100-FC26-1	Cable 26 core x 28 AWG
3 m	AXT100-FC26-2	
5 m	AXT100-FC26-3	

* For other commercial connectors, use a 26 pin connector with strain relief conforming to MIL-C-83503.

Example of connector manufacturers

- HIROSE ELECTRIC CO., LTD.
- Japan Aviation Electronics Industry, Limited
- 3M Japan Limited
- J.S.T. Mfg. Co., Ltd.
- Fujitsu Limited

■ Plug

These are inserted in unused cylinder ports and SUP, EXH ports. Purchase orders are available in units of 10 pieces.

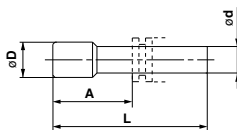

Dimensions

Applicable fittings size oD	Model	A	L	D
4	10-KQP-04	16	32	6
6	10-KQP-06	18	35	8
8	10-KQP-08	20.5	39	10
10	10-KQP-10	22	43	12
12	10-KQP-12	24	44.5	14
1/8"	10-KQP-01	16	31.5	5
5/32"	10-KQP-03	16	32	6
1/4"	10-KQP-07	18	35	8.5
5/16"	10-KQP-09	20.5	39	10
3/8"	10-KQP-11	22	43	11.5

Type 45 Series 10-SY3000/5000

5 Port Solenoid Valve
Base Mounted Manifold
Stacking Type/DIN Rail Mounted/Individual Wiring

Note) AC-type models that are CE-compliant have DIN terminals only.  [Option]

How to Order Manifold

10-SS5Y 3 -45-05 U -C6 - - -

• Clean series

• Series

3	10-SY3000
5	10-SY5000

• Valve stations

02	2 stations
⋮	⋮
20	20 stations

• SUP/EXH block assembly mounting position

Symbol	Mounting position	Applicable no. of stations
U	U side	2 to 10 stations
D	D side	2 to 10 stations
B	Both sides	2 to 20 stations
M*	Special specifications	

* For special specifications, indicate separately with the manifold specification sheet.

• Option

When a longer DIN rail is desired than the specified stations, specify the station number to be required. (20 stations at maximum)

• CE-compliant

Nil	—
Q	CE-compliant

Note) AC-type models that are CE-compliant have DIN terminals only.

• A, B port size

One-touch fitting (Metric size)

Symbol	Port size	Applicable series
C4	ø4 One-touch fitting	10-SY3000
C6	ø6 One-touch fitting	
M	Mixed	
C4	ø4 One-touch fitting	10-SY5000
C6	ø6 One-touch fitting	
C8	ø8 One-touch fitting	
M	Mixed	

One-touch fitting (Inch size)

Symbol	Port size	Applicable series
N3	ø $\frac{5}{16}$ " One-touch fitting	10-SY3000
N7	ø $\frac{1}{4}$ " One-touch fitting	
M	Mixed	
N3	ø $\frac{5}{16}$ " One-touch fitting	10-SY5000
N7	ø $\frac{1}{4}$ " One-touch fitting	
N9	ø $\frac{3}{16}$ " One-touch fitting	
M	Mixed	

* For mixed specifications (M), indicate separately on the manifold specification sheet.

* Refer to pages 166 and 167 for external pilot specifications and built-in silencer.

How to Order Manifold Assembly (Example)

Example

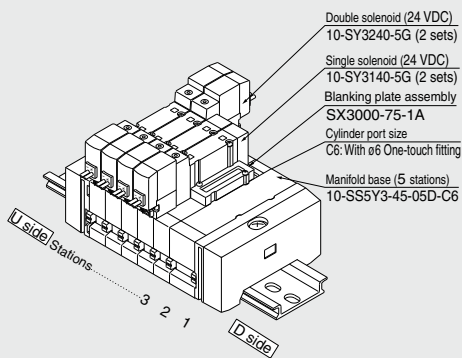

10-SSY3-45-05D-C6... 1 set (Type 45, 5-station manifold base part no.)
 *SX3000-75-1A 1 set (Blanking plate assembly part no.)
 *10-SY3140-5G 2 sets (Single solenoid part no.)
 *10-SY3240-5G 2 sets (Double solenoid part no.)

The asterisk denotes the symbol for assembly. Prefix it to the part no. of the solenoid valve, etc.

The valve sequence is numbered as the 1st. station from the D side regardless of the mounting position of SUP/EXH block assembly. When ordering, specify the part no. in the order from the 1st. station on D side. Also, when the sequence is complicated, fill out the manifold specification sheet to instruct us.

Directional Control Valves

Air Cylinders

Rotary Actuators

Air Grippers

Air Preparation Equipment

Modular F. R.

Pressure Control Equipment

Fittings & Tubing

Flow Control Equipment

Pressure Switches/ Pressure Sensors

How to Order Valve

Note) AC-type models that are CE-compliant have DIN terminals only.

10-SY 5 2 40 - **5 L** - -

● **Clean series**

● **Series**

3	10-SY3000
5	10-SY5000

● **Actuation type**

1	2 position single
2	2 position double
3	3 position closed center
4	3 position exhaust center
5	3 position pressure center

● **Coil type**

NII	Standard
T	With power saving circuit (24, 12 VDC only)

* Power saving circuit is not available for D, Y, DO, YO or W types.

● **Rated voltage**

For DC

5	24 VDC
6	12 VDC
V	6 VDC
S	5 VDC
R	3 VDC

AC (⁵⁰/₆₀ Hz)

1	100 VAC
2	200 VAC
3	110 VAC [115 VAC]
4	220 VAC [230 VAC]

* DC specifications of type D, Y, DO and YO are only available with 12 and 24 VDC.
 * For type W , only DC voltage is available.
 * Only D and DO are available for 10-SY5000.
 Note) AC-type models that are CE-compliant have DIN terminals only.

● **CE-compliant**

NII	—
Q	CE-compliant

Note) AC-type models that are CE-compliant have DIN terminals only.

● **Made to Order**

NII	—
X90	Main valve fluororubber (Refer to page 169.)

● **Manual override**

NII	Non-locking push type
D	Push-turn locking slotted type
E	Push-turn locking lever type

● **Light/Surge voltage suppressor**

Electrical entry for G, H, L, M, W

NII	Without light/surge voltage suppressor
S	With surge voltage suppressor
Z	With indicator light and surge voltage suppressor
R	With surge voltage suppressor (Non-polar type)
U	With light/surge voltage suppressor (Non-polar type)

* For AC voltage valves there is no "S" option. It is already built into the rectifier circuit.
 * For "R" and "U", only DC voltage is available.
 * Power saving circuit is only available for the "Z" type.

Electrical entry for D, Y

NII	Without light/surge voltage suppressor
S	With surge voltage suppressor (Non-polar type)
Z	With light/surge voltage suppressor (Non-polar type)

* DOZ and YOZ are not available.
 * For AC voltage valves there is no "S" option. It is already built into the rectifier circuit.

● **Electrical entry**

24, 12, 6, 5, 3 VDC/100, 110, 200, 220 VAC				24, 12 VDC 100, 110, 200, 220 VAC	24, 12 VDC 6, 5, 3 VDC
Grommet	L plug connector	M plug connector	DIN terminal	M8 connector	
G: Lead wire length 300 mm	L: With lead wire (Length 300 mm)	M: With lead wire (Length 300 mm)	(10-SY5000 only) D: With connector	WO: Without connector cable	
H: Lead wire length 600 mm	LN: Without lead wire	MN: Without lead wire	DO: Without connector	W <input type="checkbox"/> : With connector cable ^{Note 2)}	
	LO: Without connector	MO: Without connector	Y: With connector		
			YO: Without connector		
Manifold mounting	10-SY3000	●	—	●	
	10-SY5000	●	●	●	
CE-compliant	DC	●	●	●	
	AC	—	●	—	

Note 1) The DIN terminal of the 10-SY3000 series cannot be mounted on a standard manifold. For details, refer to page 174.

Note 2) Enter the cable length symbols in . Please be sure to fill in the blank referring to page 176.

* LN, MN type: With 2 sockets.

* "Y" type is a DIN terminal conforming to EN-175301-803C (former DIN43650C).

Refer to page 173 for details.

* Refer to page 176 for connector cable of M8 connector.

* M8 connector conforming to IEC60947-5-2 standard is also available. Refer to page 168 for details.

* Refer to page 173 for the lead wire length of L and M plug connectors.

* Refer to page 174 for the connector assembly with cover for L and M plug connectors.

* When ordering a single unit of the base mounted type solenoid valve, the mounting screws and gasket for the integrated manifold are supplied with the solenoid valve, but the stacking type gasket is not included. When the stacking type gasket is required, order it separately.

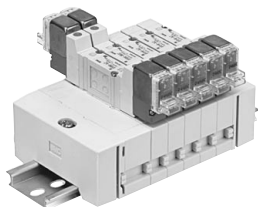

Manifold Specifications

Model	10-SS5Y3-45(-Q)		10-SS5Y5-45(-Q)	
Applicable valve	10-SY3□40		10-SY5□40	
Manifold type	Stacking type/DIN rail mounted			
P (SUP)/R (EXH)	Common SUP, Common EXH			
Valve stations	2 to 20 stations ^{Note 1)}			
A, B port Porting specifications	Location	Base		
	Direction	Side		
Port size	P, R port	C8 (ø8 One-touch fitting)	C10 (ø10 One-touch fitting)	
	A, B port	C4 (ø4 One-touch fitting)	C4 (ø4 One-touch fitting)	
		C6 (ø6 One-touch fitting)	C6 (ø6 One-touch fitting) C8 (ø8 One-touch fitting)	
Manifold base weight W (g), n: Stations	2 to 10 stations: W = 22n + 118 11 to 20 stations: W = 22n + 140		2 to 10 stations: W = 47n + 156 11 to 20 stations: W = 47n + 190	

Note 1) For more than 11 stations, supply pressure to P port on both sides and exhaust from R port on both sides.

Flow Rate Characteristics

Model	Port size		Flow rate characteristics					
	1, 5, 3 (P, EA, EB)	4, 2 (A, B)	1 → 4/2 (P → A/B)			4/2 → 5/3 (A/B → EA/EB)		
			C (dm ³ /sbar)	b	Cv	C (dm ³ /sbar)	b	Cv
10-SS5Y3-45	C8	C6	0.88	0.21	0.22	0.95	0.18	0.22
10-SS5Y5-45	C10	C8	2.2	0.24	0.53	2.5	0.18	0.58

Note) The values are for individually operated 2 position type manifold bases with 5 stations.

Directional
Control Valves

Air Cylinders

Rotary Actuators

Air Grippers

Air Preparation
Equipment

Modular F. R.

Pressure Control
Equipment

Fittings & Tubing

Flow Control
Equipment

Pressure Switches/
Pressure Sensors

Dimensions: Series 10-SY3000

[]: AC

**10-SS5Y3-45- Stations D-C4, N3
C6, N7**

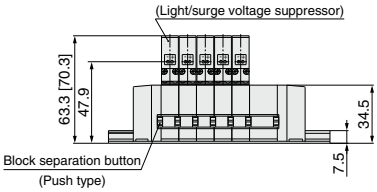
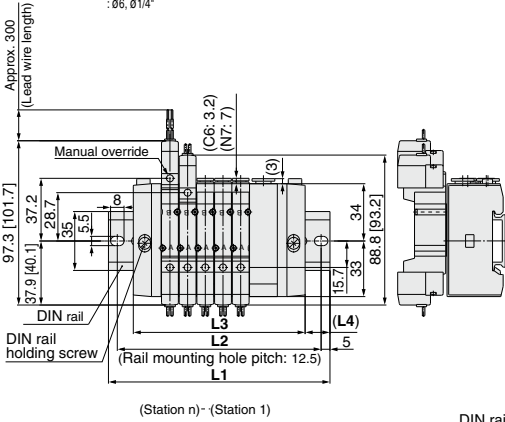
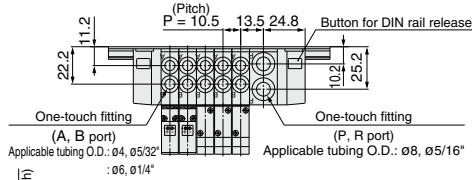

**10-SS5Y3-45- Stations U-C4, N3
C6, N7**

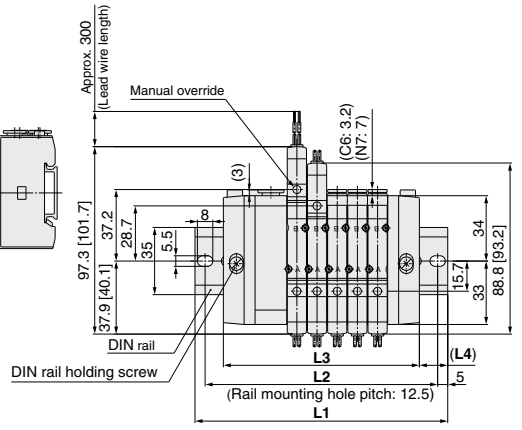
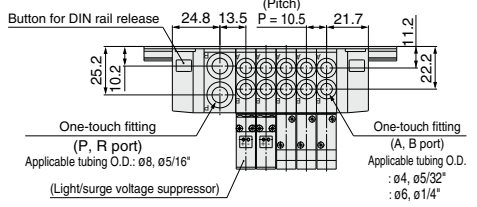

Stations	2 stations	3	4	5	6	7	8	9	10 stations
L1	98	110.5	123	135.5	148	148	160.5	173	185.5
L2	87.5	100	112.5	125	137.5	137.5	150	162.5	175
L3	70.5	81	91.5	102	112.5	123	133.5	144	154.5
L4	13.5	14.5	15.5	16.5	17.5	12.5	13.5	14.5	15.5

Dimensions: Series 10-SY3000

10-SS5Y3-45- Stations B-C4, N3
C6, N7

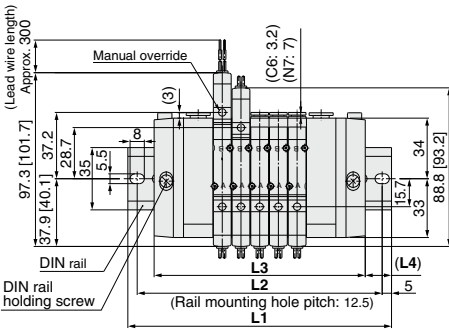
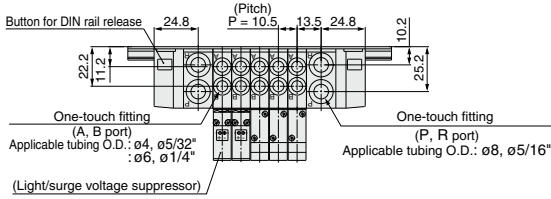

Stations	2 stations	3	4	5	6	7	8	9	10 stations
L1	110.5	123	135.5	148	160.5	173	185.5	185.5	198
L2	100	112.5	125	137.5	150	162.5	175	175	187.5
L3	87	97.5	108	118.5	129	139.5	150	160.5	171
L4	11.5	12.5	13.5	14.5	15.5	16.5	17.5	12.5	13.5

Stations	11 stations	12	13	14	15	16	17	18	19	20 stations
L1	210.5	223	235.5	248	248	260.5	273	285.5	298	310.5
L2	200	212.5	225	237.5	237.5	250	262.5	275	287.5	300
L3	181.5	192	202.5	213	223.5	234	244.5	255	265.5	276
L4	14.5	15.5	16.5	17.5	12	13	14	15	16	17

L plug connector

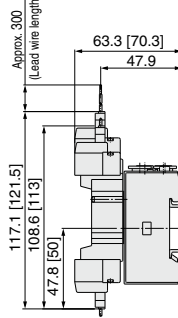

M plug connector

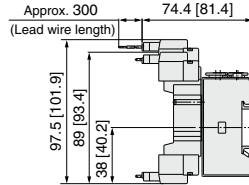

M8 connector (WO)

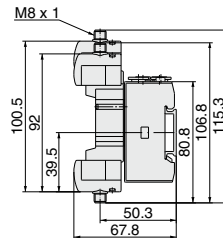

Note) Refer to page 176 for dimensions of connector types.

Directional Control Valves

Air Cylinders

Rotary Actuators

Air Grippers

Air Preparation Equipment

Modular F. R.

Pressure Control Equipment

Fittings & Tubing

Flow Control Equipment

Pressure Switches/ Pressure Sensors

Dimensions: Series 10-SY5000

[]: AC

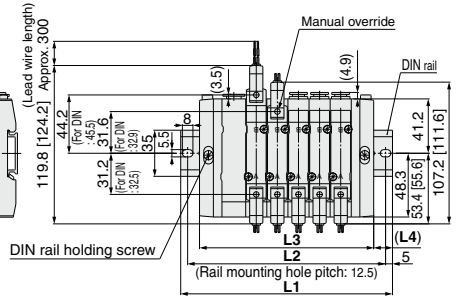
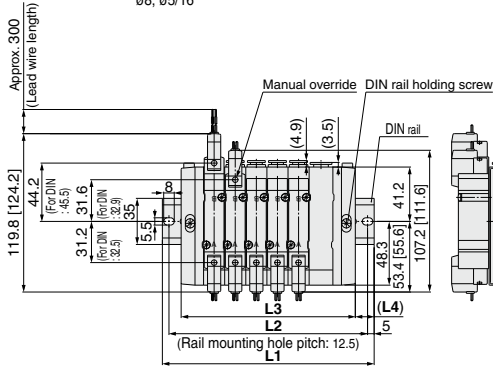
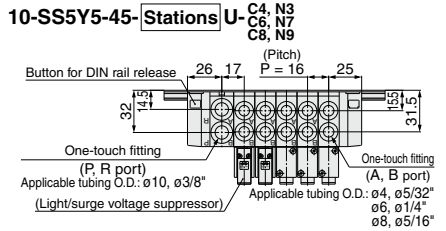
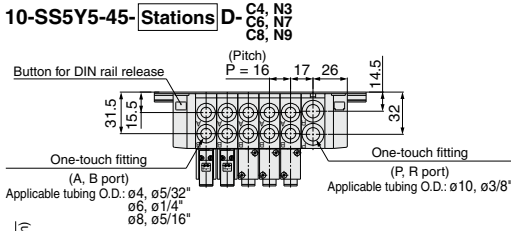

(Station n) --- (Station 1)

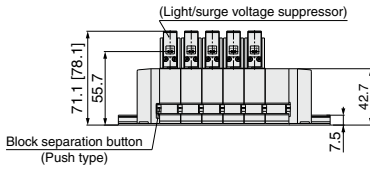

Stations	2 stations	3	4	5	6	7	8	9	10 stations
L1	110.5	135.5	148	160.5	173	198	210.5	223	235.5
L2	100	125	137.5	150	162.5	187.5	200	212.5	225
L3	84	100	116	132	148	164	180	196	212
L4	13	17.5	16	14	12.5	17	15	13.5	11.5

Dimensions: Series 10-SY5000

[]: AC

**10-SS5Y5-45- Stations B-C4, N3
C6, N7
C8, N9**

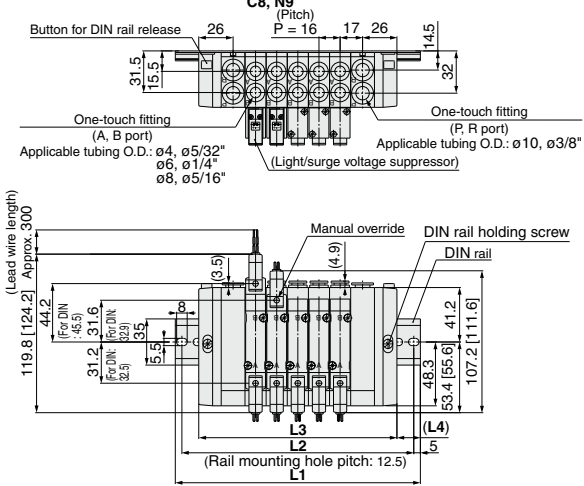

Stations	2 stations	3	4	5	6	7	8	9	10 stations
L1	135.5	148	160.5	185.5	198	210.5	223	248	260.5
L2	125	137.5	150	175	187.5	200	212.5	237.5	250
L3	102	118	134	150	166	182	198	214	230
L4	16.5	15	13	17.5	16	14	12.5	17	15

Stations	11 stations	12	13	14	15	16	17	18	19	20 stations
L1	273	285.5	310.5	323	335.5	360.5	373	385.5	398	423
L2	262.5	275	300	312.5	325	350	362.5	375	387.5	412.5
L3	246	262	278	294	310	326	342	358	374	390
L4	13.5	11.5	16	14.5	12.5	17	15.5	13.5	12	16.5

M8 connector (WO)

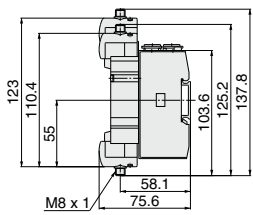

Note) Refer to page 176 for dimensions of connector types.

L plug connector

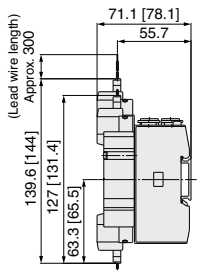

M plug connector

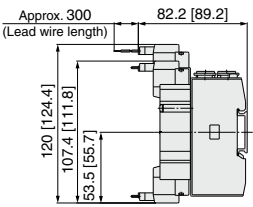

DIN terminal (D, Y)

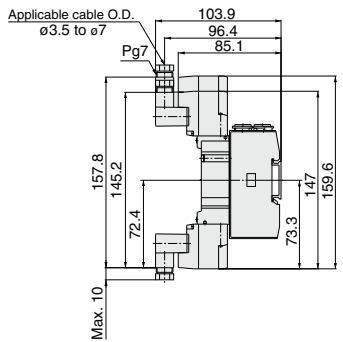

- Directional Control Valves
- Air Cylinders
- Rotary Actuators
- Air Grippers
- Air Preparation Equipment
- Modular F. R.
- Pressure Control Equipment
- Fittings & Tubing
- Flow Control Equipment
- Pressure Switches/ Pressure Sensors

Type 45-A Series 10-SY3000/5000

5 Port Solenoid Valve
Base Mounted Manifold
Stacking Type/DIN Rail Mounted/Connector Box



How to Order Manifold

10-SS5Y **3** -45- **A** **U** -05 **D** - **C6** - -

• Clean series

Series

3	10-SY3000
5	10-SY5000

Specifications

Symbol	Specifications
A	With connector box (+COM spec.)
NA	With connector box (-COM spec.)

* The style of attached lead wire assembly is different.

Connector box mounting position

Symbol	Mounting position
U	U side
D	D side

Valve stations

Symbol	Stations	Note
02	2 stations	Applicable up to 16 solenoid valves.
...
16	16 stations	

SUP/EXH block assembly mounting position

Symbol	Mounting position	Applicable stations
U	U side	2 to 10 stations
D	D side	
B	Both sides	2 to 16 stations
M*	Special specifications	

* For special specifications, indicate separately with the manifold specification sheet.

Option

When a longer DIN rail is desired than the specified stations, specify the station number to be required. (Max. 20 stations)

A/B port size

One-touch fitting (Metric size)

Symbol	Port size	Applicable series
C4	ø4 One-touch fitting	
C6	ø6 One-touch fitting	10-SY3000
M	Mixed	
C4	ø4 One-touch fitting	
C6	ø6 One-touch fitting	10-SY5000
C8	ø8 One-touch fitting	
M	Mixed	

One-touch fitting (Inch size)

Symbol	Port size	Applicable series
N3	ø ⁹ / ₃₂ " One-touch fitting	
N7	ø ¹ / ₄ " One-touch fitting	10-SY3000
M	Mixed	
N3	ø ⁹ / ₃₂ " One-touch fitting	
N7	ø ¹ / ₄ " One-touch fitting	10-SY5000
N9	ø ⁹ / ₁₆ " One-touch fitting	
M	Mixed	

* For mixed specifications, indicate separately on the manifold specification sheet.

CE-compliant

NII	—
Q	CE-compliant

* Refer to pages 166 to 167 for external pilot specifications and built-in silencer.

How to Order Manifold Assembly (Example)

Example (10-SY3000, +COM, U side)

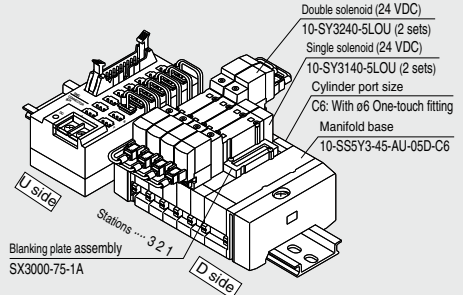

10-SS5Y3-45-AU-05D-C6... 1 set (Type 45, 5-station manifold base part no.)
* SX3000-75-1A 1 set (Blanking plate assembly part no.)
* 10-SY3140-5LOU 2 sets (Single solenoid part no.)
* 10-SY3240-5LOU 2 sets (Double solenoid part no.)
The asterisk denotes the symbol for assembly.
Prefix it to the part no. of the solenoid valve, etc.

The valve sequence is numbered as the 1st station from the D side regardless of the mounting position of connector box. When ordering, specify the part no. in the order from the 1st station on D side. Also, when the sequence is complicated, fill out the manifold specification sheet to instruct us.

10-SS5Y3-45-AU-□□□□□□ is assembled with solenoid valve and lead wire assembly when shipping. When ordering manifold only (without valves/wires/options), refer to how to order on page 150 and list the connector box (VZ3000-106-1A) and the rail stopper (TXE1-SMC) below the manifold to allow for connector box mounting at the U side. (Be sure to order a DIN rail 3 station longer than the number of the manifold stations.) In this case, please note that dimensions, L1 and L2 on pages 160 and 161 may vary slightly.) For other components, refer to the SY series of the WEB catalog.

How to Order Valve

10-SY **5** **2** 40-5 LOU - -

• Clean series

Series

3	10-SY3000
5	10-SY5000

• Rated voltage

5	24 VDC
---	--------

Actuation type

1	2 position single
2	2 position double
3	3 position closed center
4	3 position exhaust center
5	3 position pressure center

Manual override

NII	Non-locking push type
D	Push-turn locking slotted type
E	Push-turn locking lever type

Made to Order

NII	—
X90	Main valve fluororubber (Refer to page 169.)

CE-compliant

NII	—
Q	CE-compliant

* When ordering a single unit of the base mounted type solenoid valve, the mounting screws and gasket for the integrated manifold are supplied with the solenoid valve, but the stacking type gasket is not included. When the stacking type gasket is required, order it separately.

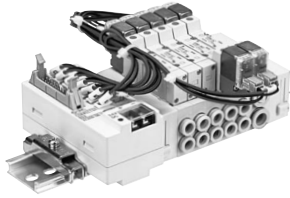

Manifold Specifications

Model	10-SS5Y3-45-NA-(Q)		10-SS5Y5-45-NA-(Q)	
Applicable valve	10-SY3□40		10-SY5□40	
Manifold type	Stacking type/DIN rail mounted			
P (SUP)/R (EXH)	Common SUP, Common EXH			
Valve stations	2 to 16 stations ^{Note 1, 2)}			
A, B port Porting specifications	Location	Base		
	Direction	Side		
Port size	P, R port	C8 (ø8 One-touch fitting)	C10 (ø10 One-touch fitting)	
	A, B port	C4 (ø4 One-touch fitting) C6 (ø6 One-touch fitting)	C4 (ø4 One-touch fitting) C6 (ø6 One-touch fitting) C8 (ø8 One-touch fitting)	
Manifold base weight W (g) n: Stations	2 to 10 stations: W = 26n + 207 11 to 20 stations: W = 26n + 229		2 to 10 stations: W = 52n + 245 11 to 16 stations: W = 52n + 279	
Applicable flat ribbon cable connector	Flat ribbon cable connector, Socket: 20 pin MIL type with strain relief conforming to MIL-C-83503			
Wiring specifications	+COM specifications (Type 45-A), -COM specifications (Type 45-NA)			

Note 1) For more than 11 stations, supply pressure to P port on both sides and exhaust from R port on both sides.

Note 2) There is a limit depending on the number of solenoids. Refer to "How to Order".

Flow Rate Characteristics

Model	Port size		Flow rate characteristics					
	1, 5, 3 (P, EA, EB)	4, 2 (A, B)	1 → 4/2 (P → A/B)			4/2 → 5/3 (A/B → EA/EB)		
			C (dm³/(s·bar))	b	Cv	C (dm³/(s·bar))	b	Cv
10-SS5Y3-45-□	C8	C6	0.88	0.21	0.22	0.95	0.18	0.22
10-SS5Y5-45-□	C10	C8	2.2	0.24	0.53	2.5	0.18	0.58

Note) The values are for individually operated 2 position type manifold bases with 5 stations.

Manifold Wiring Diagram (Circuit diagram for the reference layout)

+COM electric circuit diagram

(Wiring example)

Connector box terminals: 0, 1, 2, 3, 4, 5, 6

Station 1: SOL.a

Station 2: SOL.a

Station 3: SOL.a

Station 4: SOL.a

Station 5: SOL.a

Station 5: SOL.b

Power supply terminal

-COM electric circuit diagram

(Wiring example)

Connector box terminals: 0, 1, 2, 3, 4, 5, 6

Station 1: SOL.a

Station 2: SOL.a

Station 3: SOL.a

Station 4: SOL.a

Station 5: SOL.a

Station 5: SOL.b

Power supply terminal

Reference layout

U side

D side

SoL. B

SoL. A

SoL. A

Station n

Station 2

Station 1

- The connector box for +COM allows transmission to G71-OD16, manufactured by OMRON Corp., to be connected directly for serial transmission.
- When an external power source must be supplied to the manifold, correct polarity must be observed, otherwise damage to the PLC is possible.
- The wiring of solenoid valves, corresponds with the labeled connector box 0 to 15 from the D side.
- If valves other than the non-polar type are used, this may cause malfunction.

Manifold Option

- Individual SUP spacer assembly**
- Individual EXH spacer assembly**
- SUP block disk**
- EXH block disk**

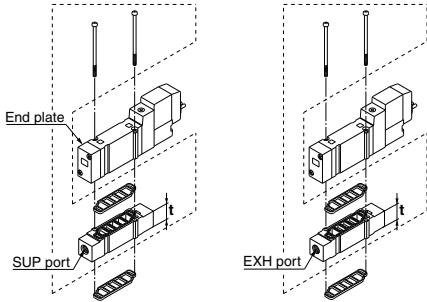

By installing a SUP block disk in the pressure supply passage of a manifold valve, it is possible to supply two or more different high and low pressures to one manifold.

By installing an EXH block disk in the exhaust passage of a manifold valve, it is possible to divide the valve's exhaust so that it does not affect another valve. (Two block disks are needed to divide both exhausts.)



Series	Part no.
10-SY3000	SX3000-77-1A
10-SY5000	SX5000-77-1A

Series	Part no.
10-SY3000	SX3000-77-1A
10-SY5000	SX5000-77-1A

Label for block disk

The labels shown below are used on manifold stations containing SUP/EXH block disk(s) to show their location. (3 pcs. each)

VZ3000-123-1A

Label for SUP block disk Label for EXH block disk Label for SUP/EXH block disk

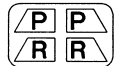
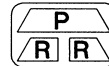

Note) When a block disk is concurrently ordered by specifying it on the manifold specification sheet, etc., a label will be attached to the position where the block disk is mounted.

Series	Assembly part no.	Port size	t
10-SY3000	SY3000-38-2A(-Q)	M5 x 0.8	11
10-SY5000	SY5000-38-16-A(-Q)	1/8"	15

Note) The SUP port may be either on the lead wire side or on the end plate side. However, as the CE-compliant products (-Q) must be mounted in the specified direction, the port directions cannot be changed. (An assembly is shipped under the condition shown in the figure.)

Series	Assembly part no.	Port size	t
10-SY3000	SY3000-39-2A(-Q)	M5 x 0.8	11
10-SY5000	SY5000-39-16-A(-Q)	1/8"	15

Note) The EXH port may be either on the lead wire side or on the end plate side. However, as the CE-compliant products (-Q) must be mounted in the specified direction, the port directions cannot be changed. (An assembly is shipped under the condition shown in the figure.)

Cable assembly

AXT100-FC20-1

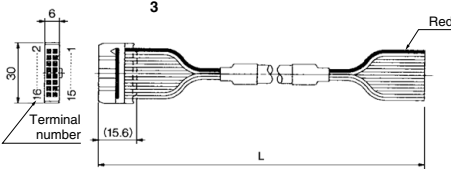

Connector Assembly for Flat Ribbon Cables

Cable length (L)	Assembly part no.	Note
1.5 m	AXT100-FC20-1	Cable 20 core x 22 AWG
3 m	AXT100-FC20-2	
5 m	AXT100-FC20-3	

* For other commercial connectors, use a 20 pin connector with strain relief conforming to MIL-C-83503.

Example of connector manufacturers

- Japan Aviation Electronics Industry, Limited
- 3M Japan Limited
- J.S.T. Mfg. Co., Ltd.
- Fujitsu Limited

Warning

When mounting a valve or spacer on the manifold base or sub-plate, etc., those mounting directions are determined. If mounted in the wrong direction, the equipment to be connected may cause malfunction. Refer to external dimensions, and then mount it.

Plug

These are inserted in unused cylinder ports and SUP, EXH ports. Purchase orders are available in units of 10 pieces.

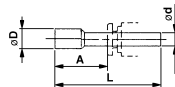

Dimensions

Applicable fittings size ϕd	Model	A	L	D
4	10-KQP-04	16	32	6
6	10-KQP-06	18	35	8
8	10-KQP-08	20.5	39	10
10	10-KQP-10	22	43	12
1/8"	10-KQP-01	16	31.5	5
5/32"	10-KQP-03	16	32	6
1/4"	10-KQP-07	18	35	8.5
5/16"	10-KQP-09	20.5	39	10

Dimensions: Series 10-SY3000

10-SS5Y3-45-AU-Stations D-C4, N3
C6, N7

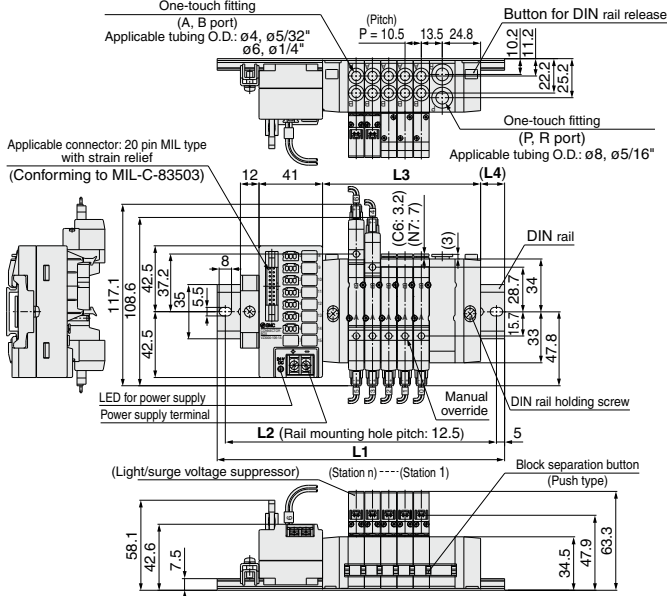

10-SS5Y3-45-AD-Stations U-C4, N3
C6, N7

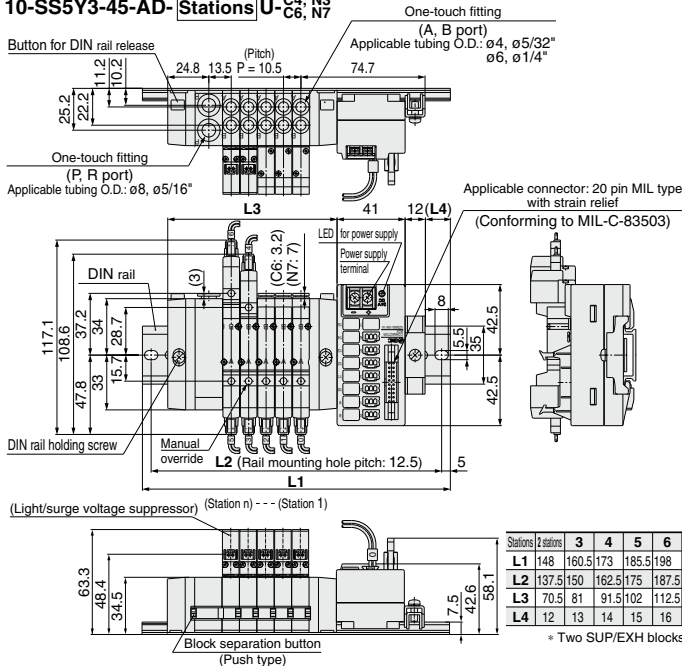

Stations	2 stations	3	4	5	6	7	8	9	10	11	12	13	14	15	16 stations
L1	148	160.5	173	185.5	198	210.5	210.5	223	235.5	260.5	273	285.5	298	310.5	310.5
L2	137.5	150	162.5	175	187.5	200	200	212.5	225	250	262.5	275	287.5	300	300
L3	70.5	81	91.5	102	112.5	123	133.5	144	154.5	181.5	192	202.5	213	223.5	234
L4	12	13	14	15	16	17	12	13	14	13	14	15	16	17	11.5

* Two SUP/EXH blocks are provided for models with 11 stations or more.

Directional Control Valves
Air Cylinders
Rotary Actuators
Air Grippers
Air Preparation Equipment
Modular F. R.
Pressure Control Equipment
Fittings & Tubing
Flow Control Equipment
Pressure Switches
Pressure Sensors

Dimensions: Series 10-SY5000

10-SS5Y5-45-AU- Stations D- C4, N3 C6, N7 C8, N9

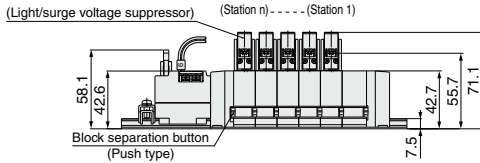
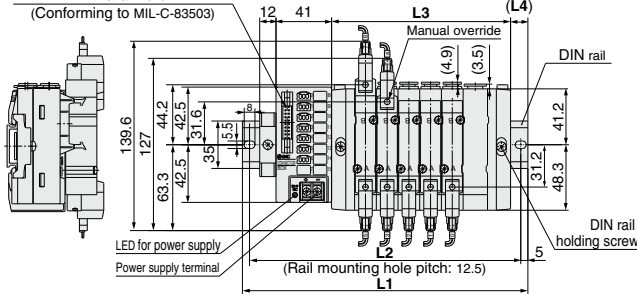
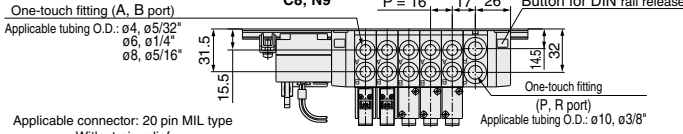

10-SS5Y5-45-AD- Stations U- C4, N3 C6, N7 C8, N9

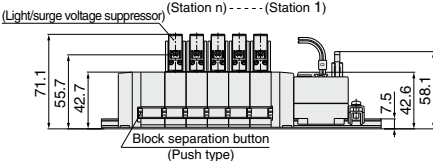
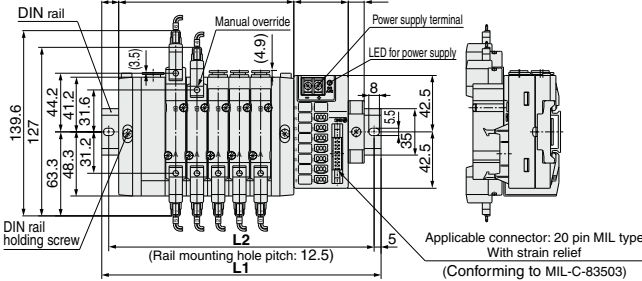
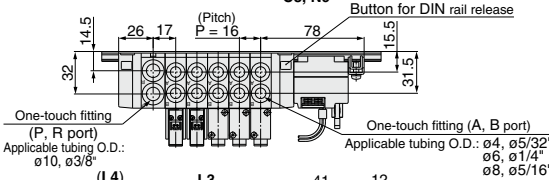

Stations (2 stations)	3	4	5	6	7	8	9	10	11	12	13	14	15	16 stations	
L1	160.5	185.5	198	210.5	235.5	248	260.5	273	298	323	348	360.5	373	398	410.5
L2	150	175	187.5	200	225	237.5	250	262.5	287.5	312.5	337.5	350	362.5	387.5	400
L3	84	100	116	132	148	164	180	196	212	246	262	278	294	310	326
L4	11.5	16	14.5	12.5	17	15.5	13.5	12	16.5	12	16.5	14.5	13	17.5	15.5

* Two SUP/EXH blocks are provided for models with 11 stations or more.

Series 10-SY300/500 3 Port Valve Mixed Mounting Type on 5 Port Valve Manifold



3 port valve can be mounted on manifold for 5 port valve.

Single Unit

Brackets and sub-plates are the same as the 10-SY3000/5000 series.

Applications

Mounting on all kinds of manifolds for the 10-SY3000/5000 series. Refer to "How to Order Manifold" for details.

How to Order Manifold Assembly (Example)

Example

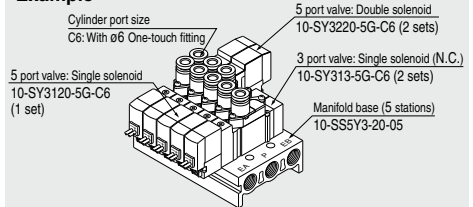

- 10-SS5Y3-20-05 1 set (Type 20, 5-station manifold base part no.)
- * 10-SY313-5G-C6 2 sets (3 port valve, type NC part no.)
- * 10-SY3120-5G-C6 ... 1 set (5 port valve, single solenoid part no.)
- * 10-SY3220-5G-C6 ... 2 sets (5 port valve, double solenoid part no.)

The asterisk denotes the symbol for assembly.
Prefix it to the part no. of the solenoid valve, etc.

Add the valve and option part number under the manifold base part number.
For complex arrangements, specify them on the manifold specification sheet.

Specifications

Dimensions, specifications, solenoid specifications, response time and effective area are the same as the 5 port valve.

Directional Control Valves

Air Cylinders

Rotary Actuators

Air Grippers

Air Preparation Equipment

Modular F. R.

Pressure Control Equipment

Fittings & Tubing

Flow Control Equipment

Pressure Switches/ Pressure Sensors



Body Ported/How to Order Valve

(Note) AC-type models that are CE-compliant have DIN terminals only. [Option]

For single and individual wiring: For 10-SS5Y₃-20



Clean series

Series	3	10-SY300
	5	10-SY500

Actuation type

1	Normally closed (N.C.)
2	Normally open (N.O.)

Solenoid type

Nil	Single solenoid
D	Double solenoid

Coil type

Nil	Standard
T	With power saving circuit (24 VDC, 12 VDC only)

* Power saving circuit is not available for D, Y, DO, YO or W□ types.

Rated voltage

For DC		For AC	
5	24 VDC	1	100 VAC
6	12 VDC	2	200 VAC
V	6 VDC	3	110 VAC [115 VAC]
S	5 VDC	4	220 VAC [230 VAC]
R	3 VDC		

* DC specifications of Type D, Y, DO and YO are only available with 12 and 24 VDC.

* For type W□, only DC voltage is available.

(Note) AC-type models that are CE-compliant have DIN terminals only.

Electrical entry

24, 12, 6, 5, 3 VDC 100, 110, 200, 220 VAC			24, 12 VDC 100, 110, 200, 220 VAC	24, 12 VDC 6, 5, 3 VDC
Grommet	L plug connector	M plug connector	DIN terminal	M8 connector
G: Lead wire length 300 mm	L: With lead wire (Length 300 mm)	M: With lead wire (Length 300 mm)	(10-SY500 only) D: With connector	WO: Without connector cable
H: Lead wire length 600 mm	LN: Without lead wire	MN: Without lead wire	DO: Without connector	W□: With connector cable (Note)
	LO: Without connector	MO: Without connector	Y: With connector	
			YO: Without connector	
CE-compliant	DC	AC		

- * LN, MN type: With 2 sockets.
 - * Refer to page 174 for DIN terminal type of the 10-SY3000 series.
 - * "Y" type is a DIN terminal conforming to EN-175301-803C (former DIN43650C). For details, refer to page 173.
 - * For connector cable of M8 connector, refer to page 176.
 - * M8 connector conforming to IEC60947-5-2 standard is also available. Refer to page 168 for details.
 - * Refer to page 173 for the lead wire length of L and M plug connectors.
 - * Refer to page 174 for the connector assembly with cover for L and M plug connectors.
- (Note) Enter the cable length symbols in □. Please be sure to fill in the blank referring to page 176.

CE-compliant

Nil	—
Q	CE-compliant

(Note) AC-type models that are CE-compliant have DIN terminals only.

Thread type

Nil	Rc
F	G
N	NPT
T	NPTF

* Except for M5

Bracket (For single unit)

Nil	Without bracket
F1	With foot bracket (Single solenoid type only)
F2	With side bracket

* Brackets are the same as the 10-SY3000/5000 series.

* For bracket pin number, refer to the SY series of the WEB catalog.

A port size
Thread piping

Symbol	Port size	Applicable series
M5	M5 x 0.8	10-SY300
01	1/8"	10-SY500

One-touch fitting (Metric size)

Symbol	Port size	Applicable series
C4	ø4 One-touch fitting	10-SY300
C6	ø6 One-touch fitting	10-SY300
C4	ø4 One-touch fitting	10-SY500
C6	ø6 One-touch fitting	10-SY500
C8	ø8 One-touch fitting	10-SY500

One-touch fitting (Inch size)

Symbol	Port size	Applicable series
N3	ø3/8" One-touch fitting	10-SY300
N7	ø7/16" One-touch fitting	10-SY300
N3	ø3/8" One-touch fitting	10-SY500
N7	ø7/16" One-touch fitting	10-SY500
N9	ø9/16" One-touch fitting	10-SY500

Manual override

Nil	Non-locking push type
D	Push-turn locking slotted type
E	Push-turn locking lever type

Light/Surge voltage suppressor

Electrical entry for G, H, L, M, W		Electrical entry for D, Y (10-SY500 only)	
Nil	Without light/surge voltage suppressor	Nil	Without light/surge voltage suppressor
S	With surge voltage suppressor	S	With surge voltage suppressor
Z	With light/surge voltage suppressor	Z	With light/surge voltage suppressor
R	With surge voltage suppressor (Non-polar type)		
U	With light/surge voltage suppressor (Non-polar type)		

* For AC voltage valves there is no "S" option. It is already built into the rectifier circuit.
 * For "R" and "U", only DC voltage is available.
 * Power saving circuit is only available for the "Z" type.

(Note) When placing an order for body ported solenoid valves as a single unit, the mounting screws for the manifold and gasket are not attached. Order them separately, if necessary.

Gasket assembly part no.

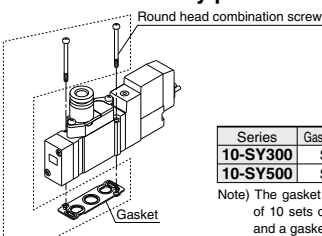

Series	Gasket assembly part no.
10-SY300	SY3000-GS-1
10-SY500	SY5000-GS-1

(Note) The gasket assembly consists of 10 sets of mounting screws and a gasket.



Note) CE-compliant: For DC only. [Option]

Body Ported/How to Order Valve

Flat ribbon cable: For 10-SS5Y³₅-20P

Coil type

Nil	Standard
T	With power saving circuit

Light/Surge voltage suppressor

Z	With light/surge voltage suppressor
U	With light/surge voltage suppressor (Non-polar type)

Note) Z: Positive common specifications only.
* Power saving circuit is only available for the "Z" type.

Rated voltage

5	24 VDC
6	12 VDC

A port size Thread piping

Symbol	Port size	Applicable series
M5	M5 x 0.8	10-SY300
01	1/8	10-SY500

One-touch fitting (Metric size)

Symbol	Port size	Applicable series
C4	ø4 One-touch fitting	10-SY300
C6	ø6 One-touch fitting	10-SY500
C6	ø6 One-touch fitting	
C8	ø8 One-touch fitting	

One-touch fitting (Inch size)

Symbol	Port size	Applicable series
N3	ø ³ / ₃₂ " One-touch fitting	10-SY300
N7	ø ¹ / ₄ " One-touch fitting	
N7	ø ¹ / ₄ " One-touch fitting	10-SY500
N9	ø ⁹ / ₁₆ " One-touch fitting	

CE-compliant

Nil	—
Q	CE-compliant

Note) CE-compliant: For DC only.

For DC: 10-SY 5 1 3 [] [] - 5 LO Z [] [] [] []

For AC: 10-SY 5 1 3 [] [] - 1 LOZ [] [] [] []

Clean series

3	10-SY300
5	10-SY500

Actuation type

1	Normally closed (N.C.)
2	Normally open (N.O.)

Rated voltage

1	100 VAC
3	110 VAC [115 VAC]

Solenoid type

Nil	Single solenoid
D	Double solenoid

Manual override

Nil	Non-locking push type
D	Push-turn locking slotted type
E	Push-turn locking lever type

Thread type

Nil	Rc
F	G
N	NPT
T	NPTF

* Except for M5

Base Mounted/How to Order Valve

Note) AC-type models that are CE-compliant have DIN terminals only. [Option]

For single and individual wiring: For 10-SS5Y³₅-41/42/45

10-SY 5 1 5 [] [] [] [] - 5 L [] [] [] []

Clean series

3	10-SY300
5	10-SY500

Actuation type

1	Normally closed (N.C.)
2	Normally open (N.O.)

Solenoid type

Nil	Single solenoid
D	Double solenoid

Pilot type

Nil	Internal pilot
R	External pilot

* External pilot is not available for type 41 manifold.

Coil type

Nil	Standard
T	With power saving circuit (24 VDC, 12 VDC only)

* Power saving circuit is not available for D, Y, DO, YO or WC types.

Tread type

Nil	Rc
F	G
N	NPT
T	NPTF

Note) With sub-plate only

Manual override

Nil	Non-locking push type
D	Push-turn locking slotted type
E	Push-turn locking lever type

Port size

Symbol	Applicable series
Nil	Without sub-plate
01	With 1/8 sub-plate 10-SY300
02	With 1/4 sub-plate 10-SY500

CE-compliant

Nil	—
Q	CE-compliant

Note) AC-type models that are CE-compliant have DIN terminals only.

* Sub-plates are the same as the 10-SY3000/5000 series.
* For sub-plate pin number, refer to the SY series of the WEB catalog.

Light/Surge voltage suppressor

Electrical entry for G, H, L, M, W

Nil	Without light/surge voltage suppressor
S	With surge voltage suppressor
Z	With light/surge voltage suppressor
R	With surge voltage suppressor (Non-polar type)
U	With light/surge voltage suppressor (Non-polar type)

* For AC voltage valves there is no "S" option. It is already built into the rectifier circuit.
* For "R" and "U", only DC voltage is available.
* The power saving circuit is only available for the "Z" type.

Electrical entry for D, Y (SY500 only)

Nil	Without light/surge voltage suppressor
S	With surge voltage suppressor
Z	With light/surge voltage suppressor

* DOZ and YOZ are not available.
* For AC voltage valves there is no "S" option. It is already built into the rectifier circuit.

Electrical entry

CE-compliant	DC	24, 12, 6, 5, 3 VDC			24, 12 VDC	
		100, 110, 200, 220 VAC	100, 110, 200, 220 VAC	DIN terminal	M8 connector	
		Grommet	L plug connector	M plug connector	DIN terminal	M8 connector
		G: Lead wire length 300 mm	L: With lead wire (Length 300 mm)	M: With lead wire (Length 300 mm)	(10-SY500 only) D: With connector DO: Without connector Y: With connector YO: Without connector	WO: Without connector cable WC: With connector cable (Note)
		H: Lead wire length 600 mm	LN: Without lead wire LO: Without connector	MN: Without lead wire MO: Without connector		

Rated voltage

For DC	AC
5 24 VDC	1 100 VAC
6 12 VDC	2 200 VAC
V 6 VDC	3 110 VAC
S 5 VDC	3 [115 VAC]
R 3 VDC	3 220 VAC
	4 [230 VAC]

* DC specifications of type D, Y, DO and YO are only available with 12 and 24 VDC.
* For type WC, only DC voltage is available.
Note) AC-type models that are CE-compliant have DIN terminals only.

* LN, MN type: With 2 sockets.
* Refer to page 174 for DIN terminal type of the 10-SY300 series.
* "Y" type is a DIN terminal conforming to EN-175301-803C (former DIN43650C). For details, refer to page 173.
* Refer to page 176 for connector cable of M8 connector.
* M8 connector conforming to IEC60947-5-2 standard is also available. Refer to page 168 for details.

* Refer to page 173 for the lead wire length of L and M plug connectors.
* Refer to page 174 for the connector assembly with cover for L and M plug connectors.
Note) Enter the cable length symbols in □.
Please be sure to fill in the blank referring to page 176.

Directional Control Valves

Air Cylinders

Rotary Actuators

Air Grippers

Air Preparation Equipment

Modular F. R.

Pressure Control Equipment

Fittings & Tubing

Flow Control Equipment

Pressure Switches/Pressure Sensors



Base Mounted/How to Order Valve

Note) CE-compliant:
For DC only.

[Option]

Flat ribbon cable:
Connector box type: For 10-SS5Y³-41P/42P/45-A

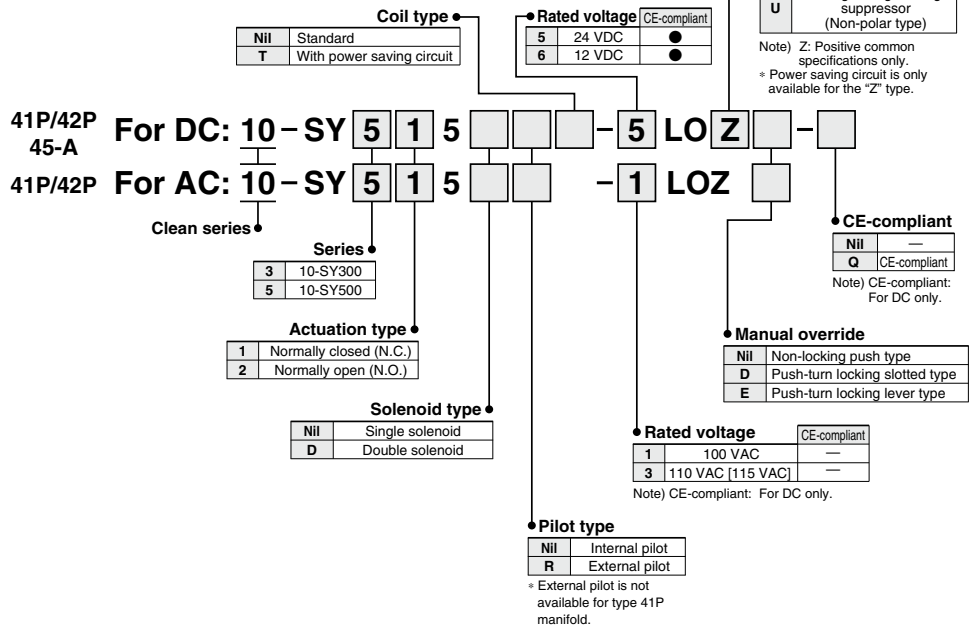

Plug-in: For 10-SS5Y³-45□

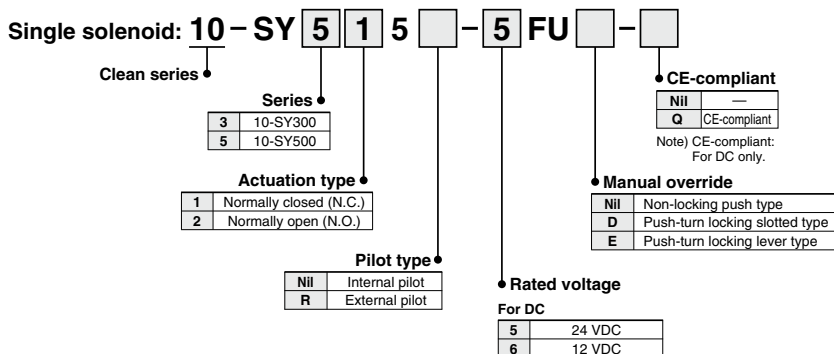

10-SY3000/5000

Made to Order

External Pilot/Built-in Silencer

External pilot manifold bases for low-pressure/vacuum use are added to split style/
DIN rail manifolds.



[Option]
Note) AC-type models that are CE-compliant have DIN terminals only.

Type 45

Individual Wiring/Connector Box Type

How to Order Manifold

Type 45
10-SS5Y 3 5-45(-A)-05 U R-C6

• Clean series

Series

Symbol	Stations
02	2 stations
⋮	⋮
20	20 stations

* Includes the number of blanking plate assemblies.

SUP/EXH block assembly mounting position

Symbol	Mounting position	Stations
U	U side	
D	D side	2 to 10 stations
B	Both sides	2 to 20 stations
M	Special specifications	

* For special specifications, indicate separately with the manifold specification sheet.

SUP/EXH block assembly

Symbol	Specifications
R	External pilot

A, B port size

Symbol	Port size	Applicable series
C4	ø4 One-touch fitting	10-SY3000
C6	ø6 One-touch fitting	
M	Mixed	
C4	ø4 One-touch fitting	10-SY5000
C6	ø6 One-touch fitting	
M	Mixed	

* For mixed specifications, indicate separately on the manifold specification sheet.

Option

When a longer DIN rail is desired than the specified stations, specify the station number to be required. (Max. 20 stations)

CE-compliant

NH	—
Q	CE-compliant

Note) AC-type models that are CE-compliant have DIN terminals only.

How to Order Manifold Assembly (Example)

Example

Single solenoid (external pilot specifications)
10-SY3140R-5G (5 sets)

Built-in silencer

Manifold base (5 stations)
10-SS5Y3-45-05DRS-C6

10-SS5Y3-45-05DRS-C6 ... 1 set (External pilot specification with built-in silencer part no.)
* 10-SY3140R-5G 5 sets (Single solenoid part no.)

↳ The asterisk denotes the symbol for assembly. Prefix it to the part no. of the solenoid valve, etc.

The valve sequence is numbered as the 1st. station from the D side regardless of the mounting position of SUP/EXH block assembly. When ordering, specify the part no. in the order from the 1st. station on D side. Also, when the sequence is complicated, fill out the manifold specification sheet to instruct us.

For manifolds with SUP/EXH block assembly at each end of the manifold, external pilot ports and silencers will be also located at each end of the manifold.

For special specifications, the SUP/EXH block assembly (SX3/5000-51-1A) shown in the **WEB catalog** of the SY series (Type 45 DIN Rail Manifold Exploded View) can also be mounted. Please specify the mounting position, by correctly filling in the blank space on the manifold specification sheet.

Directional Control Valves

Air Cylinders

Rotary Actuators

Air Grippers

Air Preparation Equipment

Modular F. R.

Pressure Control Equipment

Fittings & Tubing

Flow Control Equipment

Pressure Switches/ Pressure Sensors

How to Order Valve

Note) AC-type models that are CE-compliant have DIN terminals only.

10-SY 5 2 40 **- 5 L**

• **Clean series**

• **Series**

3	10-SY3000
5	10-SY5000

• **Actuation type**

1	2 position single
2	2 position double
3	3 position closed center
4	3 position exhaust center
5	3 position pressure center

• **Pilot type**

Nil	Internal pilot
R	External pilot

• **Coil type**

Nil	Standard
T	With power saving circuit (24 VDC, 12 VDC only)

* Power saving circuit is not available for D, Y, DO, YO or W□ types.

• **Rated voltage**

For DC

5	24 VDC
6	12 VDC
V	6 VDC
S	5 VDC
R	3 VDC

For AC (50/60 Hz)

1	100 VAC
2	200 VAC
3	110 VAC [115 VAC]
4	220 VAC [230 VAC]

* DC specifications of type D, Y, DO and YO are only available with 12 and 24 VDC.
 * For type W□, only DC voltage is available.
 * Only D, Y, DO and YO are available for 10-SY5000.
 Note) AC-type models that are CE-compliant have DIN terminals only.

• **CE-compliant**

Nil	—
Q	CE-compliant

Note) AC-type models that are CE-compliant have DIN terminals only.

• **Made to Order**

Nil	—
X90	Main valve fluororubber (Refer to page 169.)

• **Manual override**

Nil	Non-locking push type
D	Push-turn locking slotted type
E	Push-turn locking lever type

• **Light/Surge voltage suppressor**

Electrical entry for G, H, L, M, W

Nil	Without light/surge voltage suppressor
S	With surge voltage suppressor
Z	With light/surge voltage suppressor
R	With surge voltage suppressor (Non-polar type)
U	With light/surge voltage suppressor (Non-polar type)

* For AC voltage valves there is no "S" option. It is already built into the rectifier circuit.
 * For "R" and "U", only DC voltage is available.
 * Power saving circuit is only available for the "Z" type.

Electrical entry for D, Y (10-SY5000 only)

Nil	Without light/surge voltage suppressor
S	With surge voltage suppressor (Non-polar type)
Z	With light/surge voltage suppressor (Non-polar type)

* DOZ and YOZ are not available.
 * For AC voltage valves there is no "S" option. It is already built into the rectifier circuit.

• **Electrical entry**

	24, 12, 6, 5, 3 VDC 100, 110, 200, 220 VAC			24, 12 VDC 100, 110, 200, 220 VAC	24, 12 VDC 6, 5, 3 VDC
	Grommet	L plug connector	M plug connector	DIN terminal (10-SY5000 only)	M8 connector
G: Lead wire length 300 mm	L: With lead wire (Length 300 mm)	M: With lead wire (Length 300 mm)	D: With connector	WO: Without connector cable	
H: Lead wire length 600 mm	LN: Without lead wire	MN: Without lead wire	DO: Without connector	W□: With connector cable ^{Note)}	
	LO: Without connector	MO: Without connector	Y: With connector		
			YO: Without connector		
CE-compliant	DC	●	●	●	●
	AC	—	—	●	—

* LN, MN type: With 2 sockets.
 * Only D, Y, DO and YO are available for 10-SY5000.
 * "Y" type is a DIN terminal conforming to EN-175301-803C (former DIN43650C). Refer to page 173 for details.
 * Setting "SLOU" is available only for connector box type.
 * Refer to page 176 for connector cable of M8 connector.
 * M8 connector conforming to IEC60947-5-2 standard is also available. Refer to page 168 for details.
 * Refer to page 173 for the lead wire length of L and M plug connectors.
 * Refer to page 174 for the connector assembly with cover for L and M plug connectors.
 Note) Enter the cable length symbols in □. Please be sure to fill in the blank referring to page 176.

* When ordering a single unit of the base mounted type solenoid valve, the mounting screws and gasket for the integrated manifold are supplied with the solenoid valve, but the stacking type gasket is not included. When the stacking type gasket is required, order it separately.

[Series 10-SY3000/5000/7000/9000/10-SY300/500] Made to Order M8 Connector Conforming to IEC60947-5-2



How to Order Valve

* For details on specifications, refer to page 172.

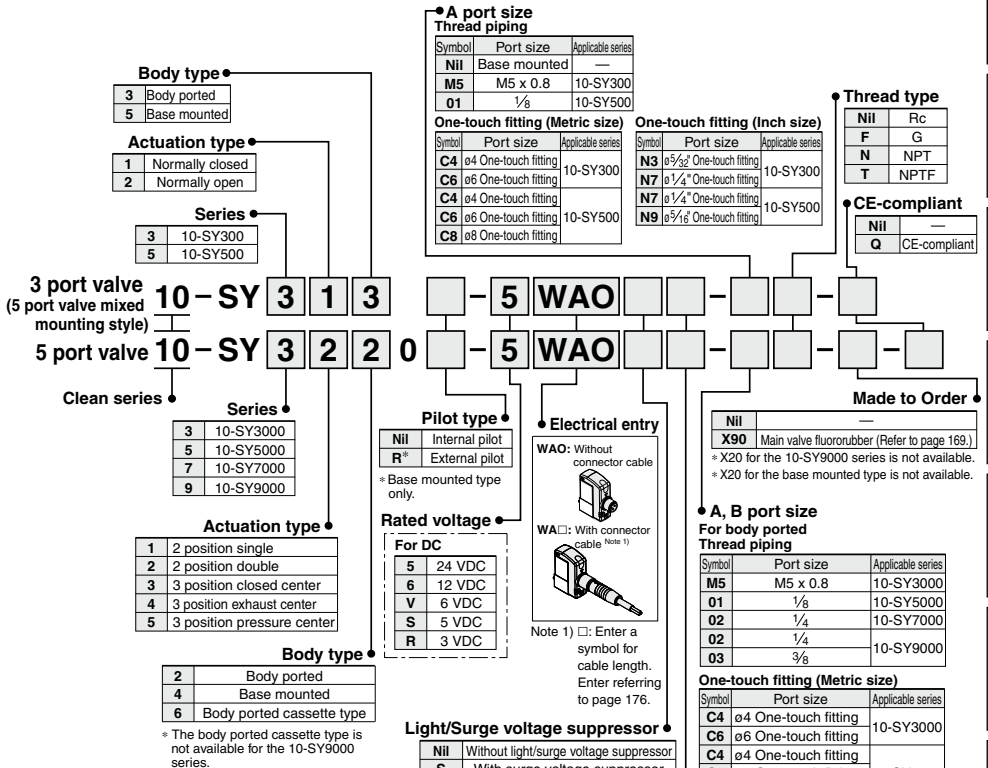

Note) When placing an order for body ported solenoid valves as a single unit, the mounting screws for the manifold and gasket are not attached. Order them separately, if necessary.

How to Order Pilot Valve

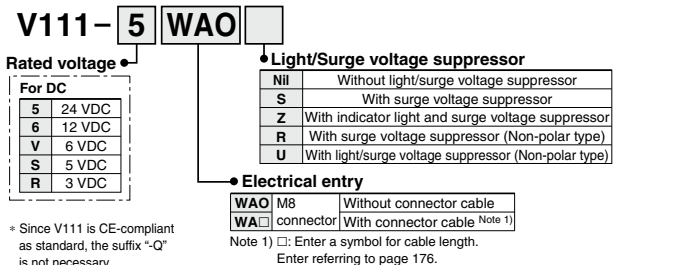

* Since V111 is CE-compliant as standard, the suffix "Q" is not necessary.

Directional Control Valves
Air Cylinders
Rotary Actuators
Air Grippers
Air Preparation Equipment
Modular F. R.
Pressure Control Equipment
Fittings & Tubing
Flow Control Equipment
Pressure Switches/Pressure Sensors

Series 10-SY3000/5000/7000/9000

Made to Order



Body Ported External Pilot/Fluororubber for Main Valve

Main Valve Fluororubber Specifications

Fluororubber is used for rubber parts of the main valve to allow use in applications such as the following.

- When using a lubricant other than the recommended turbine oil, and there is a possibility of malfunction due to swelling of the spool valve seals.

Applicable solenoid valves: Series 10-SY3□₄0, 10-SY5□₄0, 10-SY7□₄0, 10-SY9□₄0

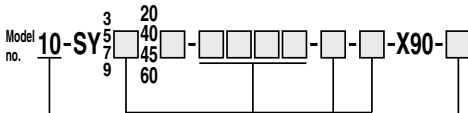

• **Entry is the same as standard products.**
Specifications and performance are the same as standard products.

• Clean series

• **CE-compliant** •

NII	—
Q	CE-compliant

Note) AC-type models that are CE-compliant have DIN terminals only.



Series 10-SY Specific Product Precautions 1

Be sure to read this before handling.
Refer to page 1382 for Safety Instructions and pages 677 to 683 for 3/4/5 Port Solenoid Valve Precautions.

Manual Override Operation

Warning

■ Non-locking push type [Standard]

Press in the direction of the arrow.

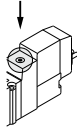

■ Push-turn locking slotted type [Type D]

While pressing the lock down, turn it in the direction of the arrow.

If it does not turn, it can be operated the same way as the non-locking type.

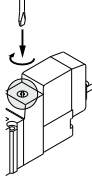

Locked position



Caution

When operating the locking type D with a screw driver, turn it gently using a watchmakers screw driver.

[Torque: Less than 0.1 N·m]

■ Push-turn locking lever type [Type E]

While pressing the lever down, turn it in the direction of the arrow.

If it does not turn, it can be operated the same way as the non-locking type.

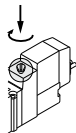

Locked position



Caution

When locking the manual override on the push-turn locking types (D, E), be sure to push the lock down before turning it.

Turning without first pushing it down can cause damage to the manual override and trouble such as air leakage, etc.

Solenoid Valve for 200, 220 VAC Specifications

Warning

Solenoid valves with grommet and L/M type plug connector AC specifications have a built-in rectifier circuit in the pilot section to operate the DC coil.

With 200 V, 220 VAC specification pilot valves, this built-in rectifier generates heat when energized. The surface may become hot depending on the energization state; therefore, do not touch the solenoid valves.

Exhaust Throttle

Caution

With the 10-SY series, the pilot valve and main valve share a common exhaust inside the valve. Therefore, do not block the exhaust port when installing the piping.

10-SY3000/5000/7000/9000 Series Used as a 3-Port Valve

Caution

When using a 5-port valve as a 3-port valve

The 10-SY3000/5000/7000/9000 series can be used as normally closed (N.C.) or normally open (N.O.) 3-port valves by closing one of the cylinder ports (A or B) with a plug. However, they should be used with the exhaust ports kept open. (Refer to pages 162 to 165 for dedicated 3-port solenoid valves.)

Plug position		B port	A port
Actuation type		N.C.	N.O.
Number of solenoids	Single	(A)4 2(B) (EA)5 1 3(EB) (P)	(A)4 2(B) (EA)5 1 3(EB) (P)
	Double	(A)4 2(B) (EA)5 1 3(EB) (P)	(A)4 2(B) (EA)5 1 3(EB) (P)

Directional Control Valves

Air Cylinders

Rotary Actuators

Air Grippers

Air Preparation Equipment

Modular F. R.

Pressure Control Equipment

Fittings & Tubing

Flow Control Equipment

Pressure Switches/ Pressure Sensors



Series 10-SY Specific Product Precautions 2

Be sure to read this before handling.

Refer to page 1382 for Safety Instructions and pages 677 to 683 for 3/4/5 Port Solenoid Valve Precautions.

How to Use Plug Connector

⚠ Caution

1. Attaching and detaching connectors

- To attach a connector, hold the lever and connector unit between your fingers and insert straight onto the pins of the solenoid valve so that the lever's pawl is pushed into the groove and locks.
- To detach a connector, remove the pawl from the groove by pushing the lever downward with your thumb, and pull the connector straight out.

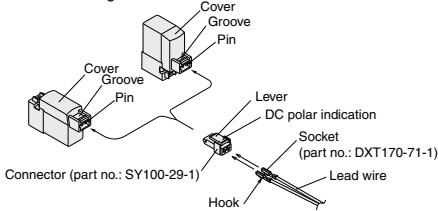

2. Crimping connection of lead wires and socket

Strip 3.2 to 3.7 mm at the end of lead wires, insert the end of the core wires evenly into the sockets, and then crimp it with a crimping tool. When this is done, take care that the coverings of the lead wires do not enter the core wire crimping area. (Please contact SMC for the dedicated crimping tools.)

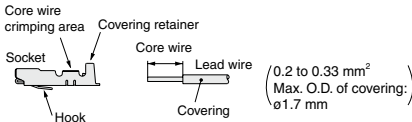

3. Attaching and detaching lead wires with sockets

• Attaching

Insert the sockets into the square holes of the connector (+, - indication), and continue to push the sockets all the way in until they lock by hooking into the seats in the connector. (When they are pushed in, the hooks open and they are locked automatically.) Then confirm that they are locked by pulling lightly on the lead wires.

• Detaching

To detach a socket from a connector, pull out the lead wire while pressing the socket's hook with a thin tipped stick (approx. 1 mm). If the socket is to be used again, first spread the hook outward.

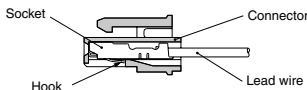

Surge Voltage Suppressor

⚠ Caution

<For DC>

Grommet, L/M Plug Connector

■ Polar type (Standard)

With surge voltage suppressor (□S)

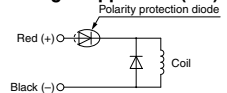

With light/surge voltage suppressor (□Z)

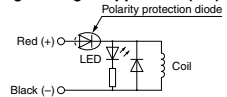

■ Non-polar type

With surge voltage suppressor (□R)

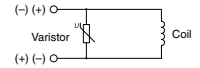

With light/surge voltage suppressor (□U)

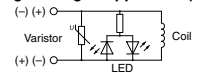

- Connect the polar type in accordance with the +, - polarity indication. (The non-polar type can be used with the connections made either way.)
- Since voltage specifications other than polar type 24 V and 12 VDC do not have diodes for polarity protection, be careful not to make errors in the polarity.
- When wiring is done at the factory, positive (+) is red and negative (-) is black.

■ With power saving circuit

Power consumption is decreased by 1/4 by reducing the wattage required to hold the valve in an energized state. (Effective energizing time is over 62 ms at 24 VDC.)

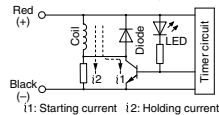

Operating Principle

With the above circuit, the current consumption when holding is reduced to save energy. Please refer to the electric wave data below.

- Please be careful not to reverse the polarity, since a diode to prevent the reversed current is not provided for the power saving circuit.

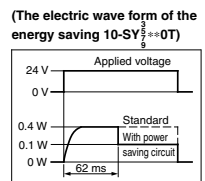



Series 10-SY Specific Product Precautions 3

Be sure to read this before handling.
Refer to page 1382 for Safety Instructions and pages 677 to 683 for 3/4/5 Port Solenoid Valve Precautions.

Surge Voltage Suppressor

DIN Terminal

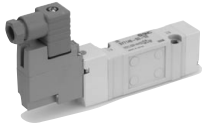

With surge voltage suppressor (DS)

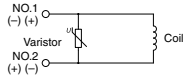

With light/surge voltage suppressor (DZ)

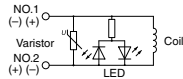

DIN terminal has no polarity.

M8 Connector

■ Polar type (Standard)

With surge voltage suppressor (□S)

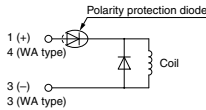

With light/surge voltage suppressor (□Z)

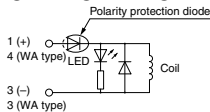

■ Non-polar type

With surge voltage suppressor (□R)

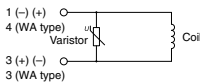

With light/surge voltage suppressor (□U)

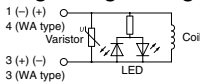

Solenoid valve side pin wiring diagram

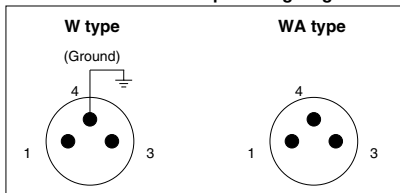

Note) The WA-type valve cannot be grounded.

M8 Connector

- For wiring of the polar type, connect + to 1 and - to 3 for type W, and + to 4 and - to 3 for type WA.
- Since voltage specifications other than polar type 24 V and 12 VDC do not have diodes for polarity protection, be careful not to make errors in the polarity.

Plug-in

Circuit for non-polar (FU)

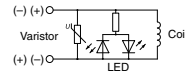

Plug-in valves have no polarity, so it's possible to use for both manifold bases for positive (10-SS5Y²-45□) and negative, it's common (10-SS5Y²-45N□) types.

<For AC>

(There is no "S" option, because the generation of surge voltage is prevented by a rectifier.)

Grommet, L/M Plug Connector

With light

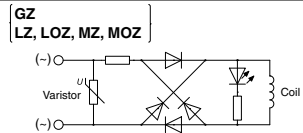

DIN Terminal

With light (DZ) (YZ)

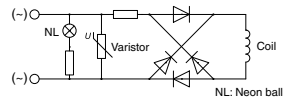

Note) The surge voltage suppressor of the varistor has residual voltage corresponding to the protective element and rated voltage. Therefore, protect the controller side from the surge voltage. The residual voltage of the diode is approximately 1 V.

Directional Control Valves

Air Cylinders

Rotary Actuators

Air Grippers

Air Preparation Equipment

Modular F. R.

Pressure Control Equipment

Fittings & Tubing

Flow Control Equipment

Pressure Switches/Pressure Sensors



Series 10-SY

Specific Product Precautions 4

Be sure to read this before handling.

Refer to page 1382 for Safety Instructions and pages 677 to 683 for 3/4/5 Port Solenoid Valve Precautions.

Plug Connector Lead Wire Length

⚠ Caution

Standard length is 300 mm, but the following lengths are also available.

How to Order Connector Assembly

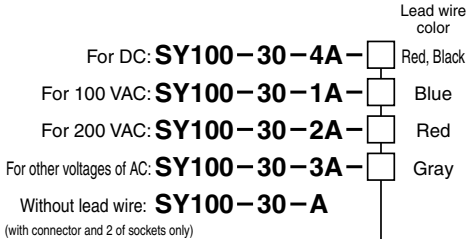

• How to Order

Specify the part numbers of the solenoid valve without connector and the connector assembly with protective cover separately.

<Example> Lead wire length 2000 mm

For DC For AC

10-SY3120-5LO-M5 10-SY3120-1LO-M5

SY100-30-4A-20 SY100-30-1A-20

Lead wire length	
Nil	300 mm
6	600 mm
10	1000 mm
15	1500 mm
20	2000 mm
25	2500 mm
30	3000 mm
50	5000 mm

How to Use DIN Terminal

⚠ Caution

Connection

1. Loosen the holding screw and pull the connector out of the solenoid valve terminal block.
2. After removing the holding screw, insert a flat head screwdriver or similar object into the notch on the bottom of the terminal block and pry it open, separating the terminal block and the housing.
3. Loosen the terminal screws (slotted screws) on the terminal block, insert the cores of the lead wires into the terminals according to the connection method, and fasten them securely with the terminal screws.
4. Secure the cord by fastening the ground nut.

⚠ Caution

When making connections, take note that using other than the supported size ($\phi 3.5$ to $\phi 7$) heavy duty cord will not satisfy IP65 (enclosure) standards. Also, be sure to tighten the ground nut and holding screw within their specified torque ranges.

Changing the entry direction

After separating the terminal block and housing, the cord entry can be changed by attaching the housing in the desired direction (4 directions at 90° intervals).

* If equipped with a light, be careful not to damage the light with the cord's lead wires.

Precautions

Plug in and pull out the connector vertically without tilting to one side.

Compatible cables

Cord O.D.: $\phi 3.5$ to $\phi 7$

(Reference) 0.5 mm², 2-core or 3-core, equivalent to JIS C 3306

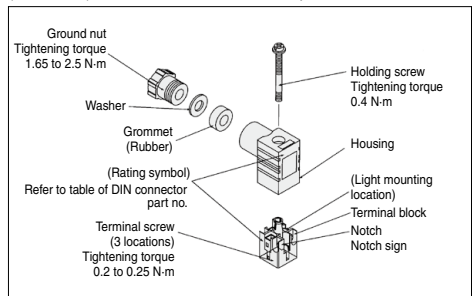

Type "Y"

DIN connector type Y is a DIN connector that conforms to the DIN pitch 8-mm standard.

- D type DIN connector with 9.4 mm pitch between terminals is not interchangeable.
- To distinguish from the D type DIN connector, "N" is listed at the end of the voltage symbol. (For connector parts without lights, "N" is not indicated. Please refer to the name plate to distinguish models.)
- Dimensions are completely the same as the D type DIN connector.
- When exchanging the pilot valve assembly only, "V115-□D" is interchangeable with "V115-□Y". Do not replace V111 (G, L, M) with V115-□D/□Y (DIN terminal), and vice versa.



Series 10-SY Specific Product Precautions 5

Be sure to read this before handling.
Refer to page 1382 for Safety Instructions and pages 677 to 683 for 3/4/5 Port Solenoid Valve Precautions.

10-SY300, 10-SY3000 Series How to Use DIN Terminal Connector

⚠ Caution

- SMC can provide a DIN terminal connector (body ported type, sub-plate type) for the 10-SY300 and 10-SY3000 series. This cannot be assembled to a standard manifold and sub-plate since the DIN connector width (15.8 mm) exceeds that of the valve body (10 mm). Contact SMC if you wish to use it with a manifold and sub-plate. Please also note that bracket F1 cannot be mounted.
- DIN terminal connectors cannot be used with single manifolds, and do not have a body ported external pilot option.

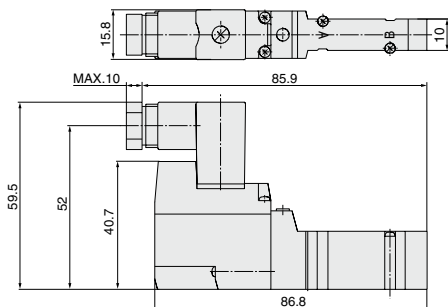

DIN Connector Part No.

⚠ Caution

<Type D>

Without light	SY100-61-1
---------------	------------

With light

Rated voltage	Voltage symbol	Part no.
24 VDC	24 V	SY100-61-3-05
12 VDC	12 V	SY100-61-3-06
100 VAC	100 V	SY100-61-2-01
200 VAC	200 V	SY100-61-2-02
110 VAC	110 V	SY100-61-2-03
220 VAC	220 V	SY100-61-2-04

<Type Y>

Without light	SY100-82-1
---------------	------------

With light

Rated voltage	Voltage symbol	Part no.
24 VDC	24 V	SY100-82-3-05
12 VDC	12 V	SY100-82-3-06
100 VAC	100 V	SY100-82-2-01
200 VAC	200 V	SY100-82-2-02
110 VAC (115 VAC)	110 V	SY100-82-2-03
220 VAC (230 VAC)	220 V	SY100-82-2-04

Circuit Diagram with Light

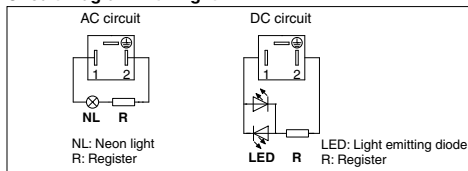

Connector Assembly with Cover

⚠ Caution

Connector assembly with dust proof protective cover.

- Effective for prevention of short circuit failure due to the entry of foreign matter into the connector.
- Chloroprene rubber for electrical use, which provides outstanding weather resistance and electrical insulation, is used for the cover material. However, do not allow contact with cutting oil, etc.
- Simple and unencumbered appearance by adopting round-shaped cord.

How to Order

SY100-68-A -

• Lead wire length (L)

Nil	300 mm
6	600 mm
10	1000 mm
15	1500 mm
20	2000 mm
25	2500 mm
30	3000 mm
50	5000 mm

Connector Assembly with Cover: Dimensions

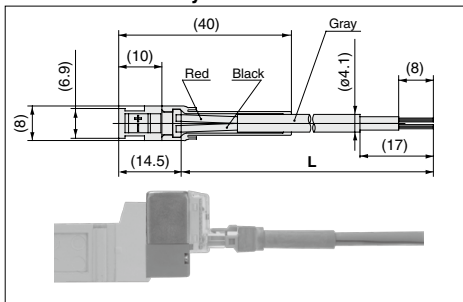

How to Order

Enter the part number for a plug connector solenoid valve without connector together with the part number for a connector assembly with cover.

<Example 1> Lead wire length of 2000 mm

10-SY3120-5LOZ-M5

SY100-68-A-20

<Example 2> Lead wire length of 300 mm (standard)

10-SY3120-5LPZ-M5

Symbol for connector assembly with cover

* In this case, the part number for the connector assembly with cover is not required.



Series 10-SY

Specific Product Precautions 6

Be sure to read this before handling.

Refer to page 1382 for Safety Instructions and pages 677 to 683 for 3/4/5 Port Solenoid Valve Precautions.

DIN Rail for 10-SY7000/9000 Series

⚠ Caution

The DIN rail used with the 10-SY7000 and SY9000 series is stronger than that used with the 10-SY3000 and SY5000 series. Use this exclusive DIN rail with the 10-SY7000 and SY9000 series. Furthermore, if using a DIN rail other than that supplied by SMC, refer to the manifold mounting section below, and mount using the same method as prescribed for side facing and rear facing, regardless of the mounting orientation.

Manifold Mounting

⚠ Caution

1. For type 23, 43, 45, 45□ and 60 DIN rail mounting, when attaching a manifold to a mounting surface, etc., with bolts, if the entire bottom surface of the DIN rail contacts the mounting surface in a horizontal mounting, it can be used by simply securing both ends of the DIN rail. However, for any other mounting method or for side facing and rear facing, etc., secure the DIN rail with bolts at uniform intervals using the following as a guide: 2 to 5 stations at 2 locations, 6 to 10 stations at 3 locations, 11 to 15 stations at 4 locations, and 16 to 20 stations at 5 locations. In addition, even in the case of a horizontal mounting, if the mounting surface is subject to vibration, etc., take the same measures indicated above. If secured at fewer than the specified number of locations, warping or twisting may occur in the DIN rail and manifold, causing trouble such as air leakage.

Also, when using mounting screws for the DIN rail on the bottom side (L3 dimension in the dimension table) of the manifold valve body, the height of the screw head has to be as follows.

Type 23, 43 (10-SY9000): 8 mm or less

Type 45 (10-SY3000, 5000): 5.8 mm or less

For type 60:

10-SY3000: 4.7 mm or less

10-SY5000: 5.8 mm or less

10-SY7000: 8 mm or less

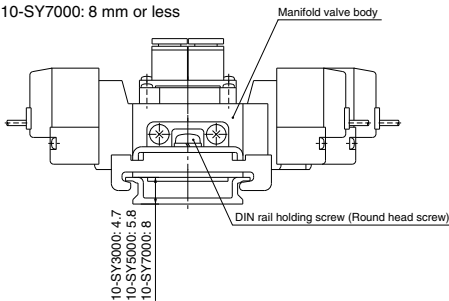

[For type 60]

Manifold Mounting

⚠ Caution

2. There will be slight variations in the width of manifold blocks due to tolerance (± 0.15 mm) for the stacking manifold type of the SS5Y9-23 series and SS5Y9-43 series.

As the manifold is made up of a combination of manifold blocks, there will be an error due to accumulated tolerance between the actual pitch dimensions of the mounting holes used to secure the manifold and the values stated in the catalog. Keep this in mind when increasing the number of stations.

One-touch Fittings

⚠ Caution

The pitch determined for each of the 10-SY series piping ports (P, A, B, etc.) is based on the assumption that the 10-KQ2 series One-touch fittings will be used. For this reason, other pipe fittings may interfere with each other depending on their type and size. Dimensions should be confirmed in a pipe fitting catalog before they are used.

• Tubing attachment/detachment for One-touch fittings

1) Attaching tubing

1. Take a tubing with no flaws on its periphery and cut it off at a right angle. When cutting the tubing, use tube cutters TK-1, 2 or 3. Do not use pinchers, nippers or scissors, etc. If cutting is done with tools other than tube cutters, the tubing may be cut diagonally or become flattened, making a secure installation impossible, and causing problems such as the tubing coming out after installation or air leakage. Allow some extra length in the tubing.
2. Grasp the tubing, slowly push it straight (0 to 5°) into the One-touch fitting until it comes to a stop.
3. After inserting the tubing, pull on it lightly to confirm that it will not come out. If it is not installed securely all the way into the fitting, this can cause problems such as air leakage or the tubing coming out.

2) Detaching tubing

1. Push in the release button sufficiently, pushing its collar equally around the circumference.
2. Pull out the tubing while holding down the release button so that it does not come out. If the release button is not pressed down sufficiently, there will be increased bite on the tubing and it will become more difficult to pull it out.
3. When the removed tubing is to be used again, cut off the portion which had been secured before reusing it. If the same portion of the tubing is reused, this can cause trouble such as air leakage or difficulty in removing the tubing.



Series 10-SY Specific Product Precautions 7

Be sure to read this before handling.
Refer to page 1382 for Safety Instructions and pages 677 to 683 for 3/4/5 Port Solenoid Valve Precautions.

Other Tubing Brands

⚠ Caution

1. When using tubing other than SMC brand tubing, confirm that the following specifications are satisfied with respect to the outside diameter tolerance of the tubing.

- | | |
|------------------------|-------------------------------------|
| 1) Nylon tubing | within ±0.1 mm |
| 2) Soft nylon tubing | within ±0.1 mm |
| 3) Polyurethane tubing | within +0.15 mm,
within -0.2 mm. |

Do not use tubing which do not meet these outside diameter tolerances. It may not be possible to connect them, or they may cause other trouble, such as air leakage or the tubing coming out after connection.

M8 Connector

⚠ Caution

1. M8 connectors have an IP65 (enclosure) rating, offering protection from dust and water. However please note that these products are not intended for use in water.

Select a SMC connector cable (V100-49-1-□) or a FA sensor type connector, with M8 threaded 3 pin specifications conforming to Nippon Electric Control Equipment Industries Association Standard, NECA4202 (IEC60947-5-2). Make sure the connector O.D. is 10.5 mm or less when used with the 10-SY3000 series manifold. If more than 10.5 mm, it cannot be mounted due to the size.

2. Do not use a tool to mount the connector, as this may cause damage. Only tighten by hand. (0.4 to 0.6 N·m)

3. Excessive stress on the cable connector will cause a loss of the IP65 rating. Please use caution and do not apply a stress of 30 N or greater.

⚠ Caution

Failure to meet IP65 performance may result if using alternative connectors than those shown above, or when insufficiently tightened.

Connector cable mounting

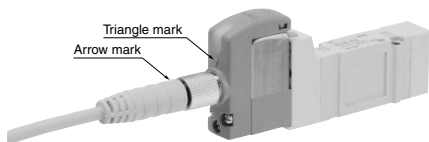

Note) Connector cable should be mounted in the correct direction. Make sure that the arrow symbol on the connector is facing the triangle symbol on the valve when using a SMC connector cable (V100-49-1-□).

Be careful not to squeeze it in the wrong direction, as problems such as pin damage may occur.

M8 Connector

⚠ Caution

■ Connector cable

- Connector cable for M8 can be ordered as follows:

How to Order

1. To order a solenoid valve and connector cable at the same time. (Connector cable will be included in the shipment of the solenoid valve.)

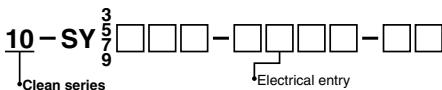

- Electrical entry
W1, WA1: Cable length 300 mm
W2, WA2: Cable length 500 mm
W3, WA3: Cable length 1000 mm
W4, WA4: Cable length 2000 mm
W7, WA7: Cable length 5000 mm
W5, WA5: Cable length 3000 mm
W6, WA6: Cable length 4000 mm

Ex. 1) Cable length: 300 mm

10-SY312-SW1ZE-C4

↳ Symbol for electrical entry

2. To order connector cable only

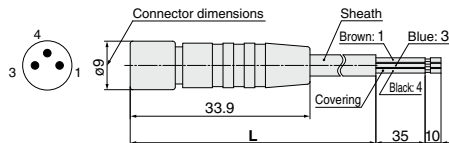

Cable length (L)	Part no.
300 mm	V100-49-1-1
500 mm	V100-49-1-2
1000 mm	V100-49-1-3
2000 mm	V100-49-1-4
5000 mm	V100-49-1-7
3000 mm	V100-49-1-5
4000 mm	V100-49-1-6

Sheath O.D.	ø3.4 mm
Cover diameter	ø1.16 mm
Conductor area	0.16 mm ²

[Dimensions when installed]

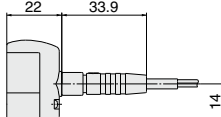

Solenoid Valve Mounting

⚠ Caution

Mount so that there is no slippage or deformation in gaskets, and tighten with the tightening torque as shown below.

Model	Thread size	Tightening torque
10-SY3000	M2	0.16 N·m
10-SY5000	M3	0.8 N·m
10-SY7000	M4	1.4 N·m
10-SY9000	M3	0.8 N·m



Series 10-SY Specific Product Precautions 8

Be sure to read this before handling.
Refer to page 1382 for Safety Instructions and pages 677 to 683 for 3/4/5 Port Solenoid Valve Precautions.

Replacement of Pilot Valve

Caution

Pilot valves in this series are improved to provide excellent energy saving results. However following this improvement, these new valves are no longer compatible with the existing pilot valve used at the interface. Consult with SMC if you need to exchange these pilot valves, for manual override (marked in orange) of the adapter plate.

New valve

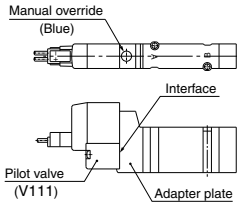

Existing valve

