

Circulating Fluid Temperature Controller Water-cooled Thermo-chiller

HRW Series



SEMATECH
S2-93, S8-95

SEMI Standard
S2-0703, S8-1103, F47-0200

Refrigerant-free and energy saving type using no compressor.
Ideal for ordinary temperature and high temperature processes.

- Type of circulating fluid: Fluorinated fluids/Ethylene glycol aqueous solution/Tap water, Deionized water
- Temperature range setting: **20 to 90°C**
- Cooling capacity: **2 kW/8 kW/15 kW/30 kW**
- Temperature stability: **±0.3°C**

**More effective energy-saving
through use of an *inverter* pump**



Inverter type

Power consumption

0.5 kWh/h

Facility water

1.2 L/min

Energy Saving and Refrigerant-free

● Energy saving and refrigerant-free (Ordinary temperature up to 90°C)

The water-cooled thermo-chiller which does not use a compressor (refrigerant-free) is suitable for processes operating from ordinary temperature to 90°C. The energy-savings shown below can be achieved in comparison with existing models (depending on the conditions).

● Power consumption: Max. 59% reduction (SMC comparison)

The power consumption can be reduced by direct heat exchange between the circulating fluid and facility water with no refrigerating circuit.

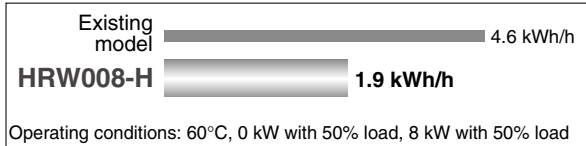

- Reduced running cost
- Contribution to the environmental preservation

● Circulating fluid: Max. 13% reduction (SMC comparison)

Enhanced temperature control technology and the unique pump/tank construction achieved the reduced circulating fluid required for operation.

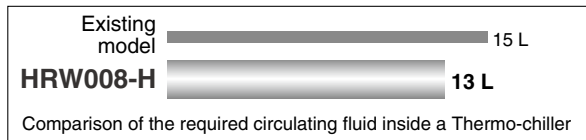

- Reduced initial cost
- Contribution to the environmental preservation

Pump Inverter Type

More effective energy-saving is achieved through use of an *inverter pump*.

● Power consumption: Max. 89% reduction (SMC comparison)

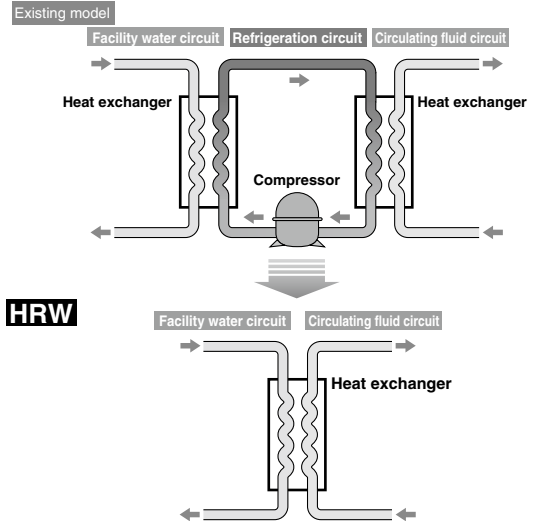
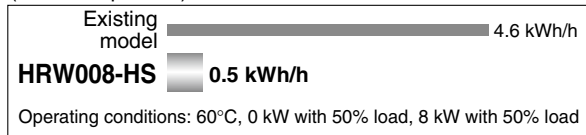

● Facility water: Max. 89% reduction (SMC comparison)

The HRW series can achieve reduction in power consumption as it does not have a compressor, and reduction in the amount of facility water used because heat is exchanged directly with the circulating fluid.

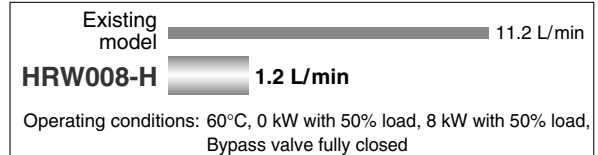

- Reduced facilities investment
- Space saved facility water equipment
- Reduced running cost

● Facility water: Max. 89% reduction (SMC comparison)

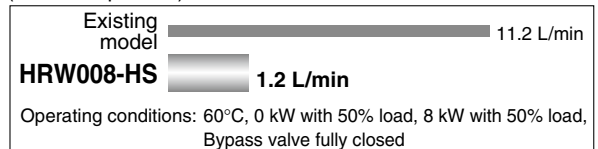

Space Saving

● Installation area: Max. 45% reduction (SMC comparison)

(Forced exhaust from rear side)

By emitting the heat from the back, ventilation slits on the side are unnecessary offering reduced installation space.

Thermo-chiller with exhaust from the side:

Body space: W400 mm x D845 mm
Ventilation space: 100 mm

HRW008-H: Body space: W380 mm x D665 mm
Ventilation space: 0

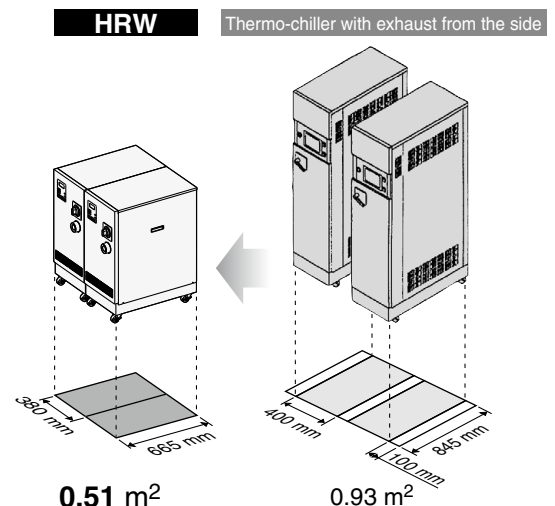

Electric Resistivity Control

DI control kit

(Refer to "Options" on page 483.)

Electric resistivity of circulating fluid (ethylene glycol aqueous solution and deionized water) can be controlled.

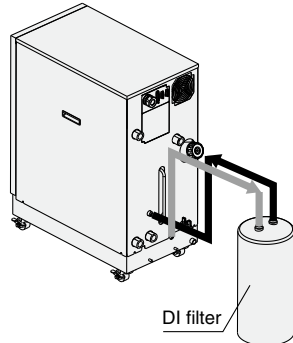

Communications

- Contact input/output signal
- Serial RS-485 communication
- Analog communication (Refer to "Options" on page 483.)
- DeviceNet communication (Refer to "Options" on page 483.)

DeviceNet[®]

■ Trademark

DeviceNet[®] is a registered trademark of ODVA, Inc.

Fluid contact parts adopt the materials compatible for various circulating fluids.

(Stainless steel, EPDM, etc.)

- Fluorinated fluids: Flourinert[™] FC-40
GALDEN[®] HT200
- 60% ethylene glycol aqueous solution
- Deionized water/Tap water

Regarding the fluid other than the above, please contact SMC.

Flourinert[™] is a trademark of 3M. GALDEN[®] is a registered trademark of Solvay Solexis, Inc.

Construction and Principles

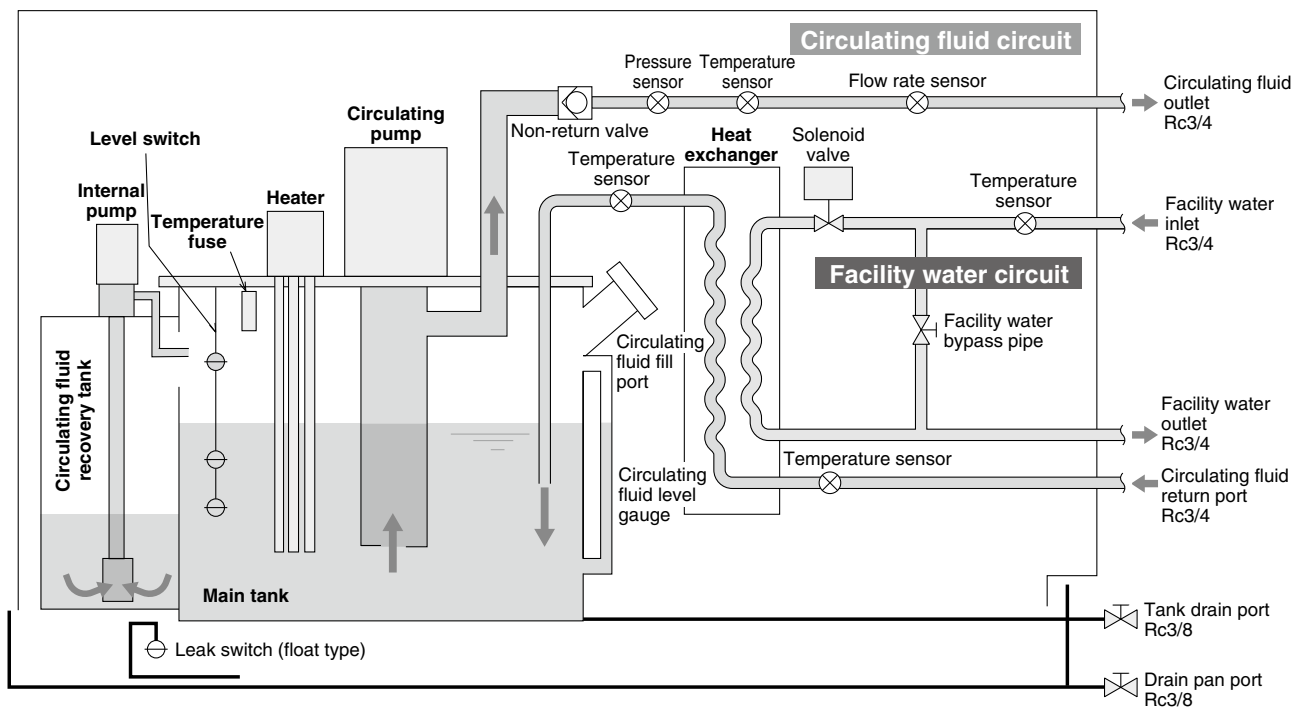

Circulating fluid circuit

With the **circulating pump**, circulating fluid will be discharged to the user's equipment side. After the circulating fluid will heat or cool the user's equipment side, it will be returned to the **main tank** via the **heat exchanger**.

When the automatic circulating fluid recovery function, which recovers the circulating fluid from the user's equipment, is selected (refer to page 484), a **sub-tank** for recovery is installed. The **internal pump** is used to transfer a circulating fluid from the **sub-tank** to the **main tank**.

Facility water circuit

When the circulating fluid temperature rises higher than the set temperature, open the **solenoid valve** to introduce facility water to the **heat exchanger**.

When the circulating fluid temperature falls back below the set temperature, close the **solenoid valve** to shut off facility water to the **heat exchanger**.

Application Examples

Semiconductor

Example: Temperature control of chamber electrode

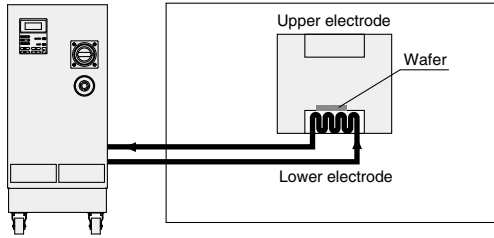

- Etching equipment
- Spatter equipment
- Cleaning equipment
- Coating equipment
- Dicing equipment
- Tester, etc.

Medical

Example: Blood preservation

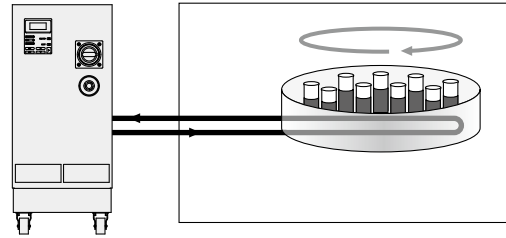

- X-ray instrument
- MRI
- Blood preservation equipment

Food

Example: Tofu (Bean curd) production

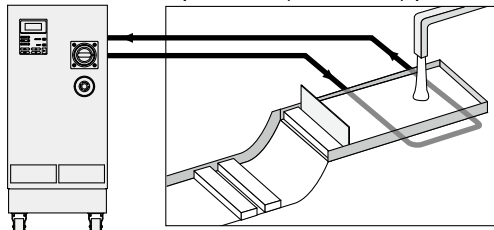

- Bottle-cleaning machine
 - Tofu (Bean curd) production equipment
 - Noodle-making machine, etc.
- Water temperature control for forming tofu by mixing the boiled soybean milk and bittern

Analysis

Example: Electronic microscope

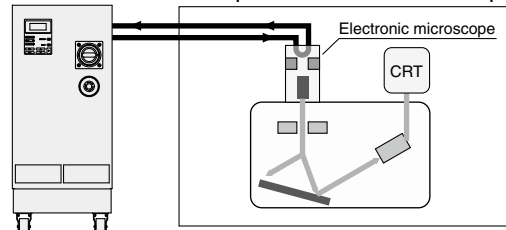

- Electron microscope
 - X-ray analytical instrument
 - Gas chromatography
 - Sugar level analytical instrument, etc.
- Prevents the distortion caused by the heat generated by the electronic gun in an electronic microscope.

Machine tool

Example: Laser machining

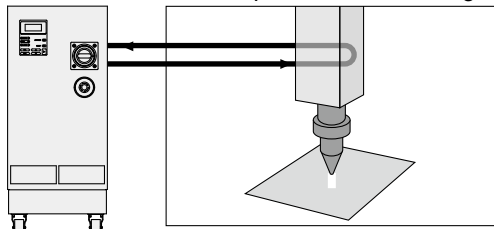

- Wire cutting
 - Grinder
 - Spot welding
 - Plasma welding
 - Laser machining, etc.
- Temperature-controlling the laser generating tube enables the laser wave length to be optimised, improving the accuracy of the machined cross sectional area.

Printing

Example: Printing temperature control

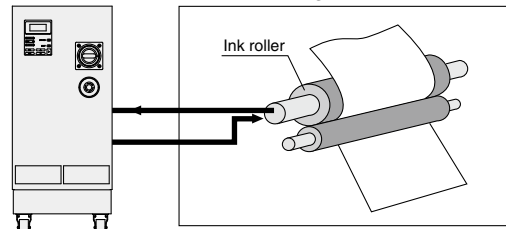

- Offset printing machine
 - Automatic developing machine
 - UV equipment, etc.
- Temperature-controlling the ink roller enables to control the evaporation amount and viscosity of an ink and optimise the tint of colors.

Molding

Example: Injection molding

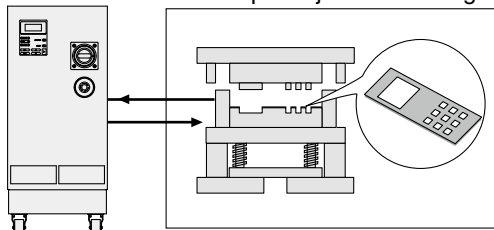

- Plastic molding
 - Rubber molding
 - Wire cable coating machine
 - Injection molding, etc.
- Temperature-controlling the mold results in improved product quality.

CONTENTS

HRW Series



Water-cooled Thermo-chiller HRW Series

● Model Selection

- Guide to Model Selection..... Page 469
- Required Cooling Capacity Calculation Page 470
- Precautions on Model Selection Page 471
- Circulating Fluid Typical Physical Property Values ... Page 472

● Fluorinated Fluid Type

- How to Order/Specifications Page 473
- Cooling Capacity/Heating Capacity/Pump Capacity ... Page 474

● Ethylene Glycol Type

- How to Order/Specifications Page 475
- Cooling Capacity/Heating Capacity/Pump Capacity ... Page 476

● Tap/Deionized Water Type

- How to Order/Specifications Page 477
- Cooling Capacity/Heating Capacity/Pump Capacity ... Page 478

● Common Specifications

- Dimensions Page 479
- Communication Functions Page 480
 - Contact Input/Output..... Page 480
 - Serial RS-485 Page 481
 - Connector Location..... Page 481
- Operation Display Panel..... Page 482
- Alarm Page 482

● Options

- Analog Communication..... Page 483
- DeviceNet Communication Page 483
- NPT Fitting..... Page 483
- SI Unit Only..... Page 483
- DI Control Kit Page 483
- Circulating Fluid Automatic Recovery..... Page 484

● Optional Accessories

- ① Bypass Piping Set Page 485
- ② Anti-quake Bracket Page 485
- ③ 4-Port Manifold Page 486
- ④ DI Filter Page 486
- ⑤ Insulating Material for DI Filter..... Page 486
- ⑥ Contaminant Filter Page 487
- ⑦ 60% Ethylene Glycol Aqueous Solution Page 487
- ⑧ Concentration Meter Page 487

- Specific Product Precautions..... Page 488

HRW Series Model Selection

Guide to Model Selection

1. How much is the temperature in degrees centigrade for the circulating fluid?

Temperature range which can be set with the thermo-chiller

H: 20°C to 90°C

Example) User requirement: 50°C

2. What kind of the circulating fluids will be used?

Relationship between circulating fluid (which can be used with the thermo-chiller) and temperature

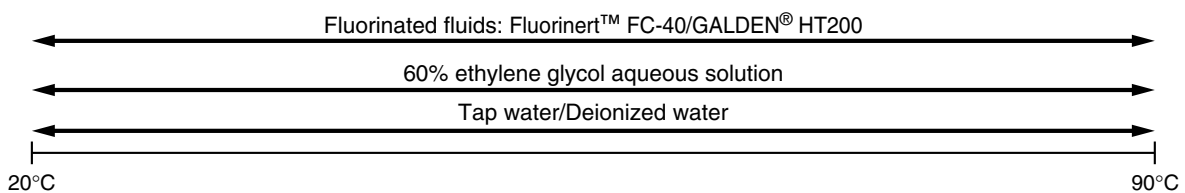

Example) User requirement: Tap water

3. How much is the temperature in degrees centigrade for the facility water?

Temperature range which can be set with the thermo-chiller

10°C to 35°C

Example) Facility water temperature of user's equipment: 15°C

Temperature difference between the circulating fluid and facility water is: $50 - 15 = 35^\circ\text{C}$.

4. What is the kW for the required cooling capacity?

Example) User requirement: 20 kW

Plot the point where the temperature difference between the circulating fluid and facility water (35°C) intersects the cooling capacity (20 kW) in the cooling capacity graph.

[Cooling Capacity Graph] Circulating Fluid: Tap Water/Deionized Water

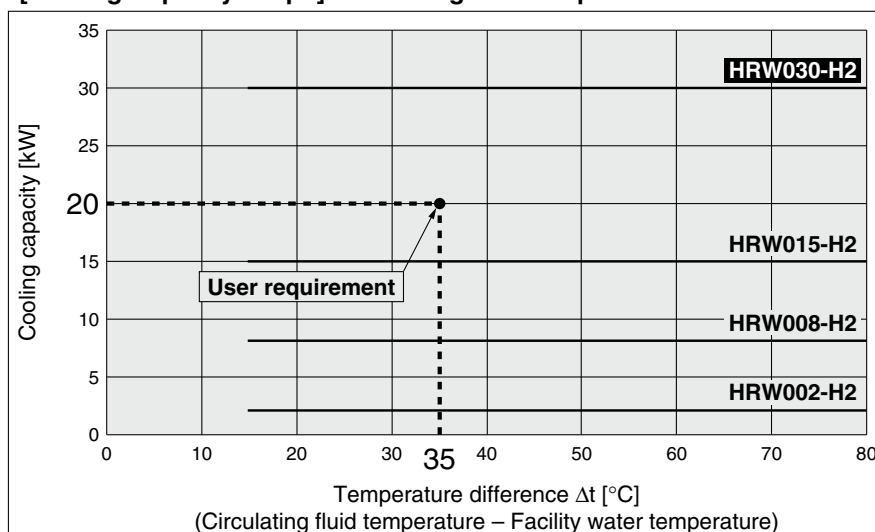

The point plotted in the graph is the requirement from the user. Select the thermo-chiller models exceeding this point. In this case, select the **HRW030-H2**.

Required Cooling Capacity Calculation

Example 1: When the heat generation amount in the user's equipment is known.

Heat generation amount **Q**: 3.5 kW

Cooling capacity = Considering a safety factor of 20%, $3.5 \times 1.2 = \boxed{4.2 \text{ kW}}$

Example 2: When the heat generation amount in the user's equipment is not known.

Obtain the temperature difference between inlet and outlet by circulating the circulating fluid inside the user's equipment.

Heat generation amount Q	: Unknown
Circulating fluid temperature difference $\Delta T (= T2 - T1)$: 6.0°C (6.0 K)
Circulating fluid outlet temperature T1	: 20°C (293.15 K)
Circulating fluid return temperature T2	: 26°C (299.15 K)
Circulating fluid flow rate L	: 20 L/min
Circulating fluid	: Fluorinated fluid
	Density γ : $1.80 \times 10^3 \text{ kg/m}^3$
	Specific heat C : $0.96 \times 10^3 \text{ J/(kg}\cdot\text{K)}$ (at 20°C)

* Refer to page 472 for the typical physical property values by circulating fluid.

$$Q = \frac{\Delta T \times L \times \gamma \times C}{60 \times 1000}$$

$$= \frac{6.0 \times 20 \times 1.80 \times 10^3 \times 0.96 \times 10^3}{60 \times 1000}$$

$$= 3456 \text{ W} = 3.5 \text{ kW}$$

Cooling capacity = Considering a safety factor of 20%,
 $3.5 \times 1.2 = \boxed{4.2 \text{ kW}}$

Example of conventional units (Reference)

Unknown

6.0°C

20°C

26°C

1.2 m³/h

Fluorinated fluid

Density γ : $1.80 \times 10^3 \text{ kg/m}^3$

Specific heat **C**: 0.23 kcal/kg·°C
(at 20°C)

* Refer to page 472 for the typical physical property values by circulating fluid.

$$Q = \frac{\Delta T \times L \times \gamma \times C}{860}$$

$$= \frac{6.0 \times 1.2 \times 1.80 \times 10^3 \times 0.23}{860}$$

$$= 3.5 \text{ kW}$$

Cooling capacity = Considering a safety factor of 20%,
 $3.5 \times 1.2 = \boxed{4.2 \text{ kW}}$

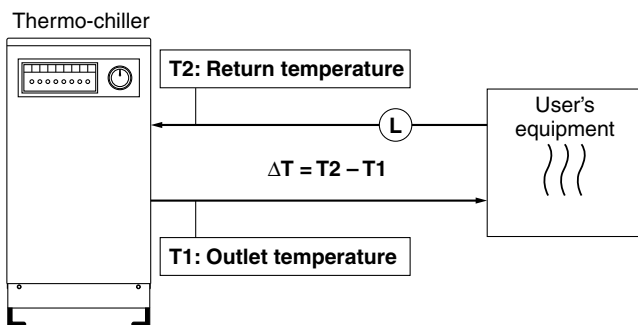

Required Cooling Capacity Calculation

Example 3. When there is no heat generation, and when cooling the object below a certain temperature and period of time.

Cooled substance total volume **V** : 60 L
 Cooling time **h** : 15 min
 Cooling temperature difference ΔT : 20°C (20 K) (70°C – 50°C → 20°C)
 Facility water temperature : 20°C (293.15 K)
 Circulating fluid : Fluorinated fluid
 Density γ : 1.74 x 10³ kg/m³
 Specific heat **C**: 1.05 x 10³ J/(kg·K)
 (at 50°C)

* Refer to page 472 for the typical physical property values by circulating fluid.

$$Q = \frac{\Delta T \times V \times \gamma \times C}{h \times 60 \times 1000}$$

$$\frac{20 \times 60 \times 1.74 \times 10^3 \times 1.05 \times 10^3}{15 \times 60 \times 1000} = 2436 \text{ W} = 2.4 \text{ kW}$$

Cooling capacity = Considering a safety factor of 20%,

$$2.4 \times 1.2 = \boxed{2.9 \text{ kW (When the circulating fluid temperature is 50°C.)}}$$

(In this case, selected thermo-chiller model will be the HRW008-H.)

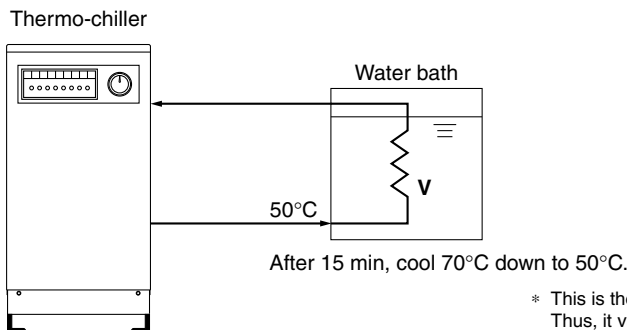

* This is the calculated value by changing the fluid temperature only.
 Thus, it varies substantially depending on the water bath or piping material or shape.

Example of conventional units (Reference)

0.06 m³
 0.25 h
 20°C
 20°C
 Fluorinated fluid
 Density γ : 1.74 x 10³ kg/m³
 Specific heat **C**: 0.25 kcal/kg·°C
 (at 50°C)

* Refer to page 472 for the typical physical property values by circulating fluid.

$$Q = \frac{\Delta T \times V \times \gamma \times C}{h \times 860}$$

$$= \frac{20 \times 0.06 \times 1.74 \times 10^3 \times 0.25}{0.25 \times 860}$$

$$= 2.4 \text{ kW}$$

Cooling capacity = Considering a safety factor of 20%,

$$2.4 \times 1.2 = \boxed{2.9 \text{ kW (When the circulating fluid temperature is 50°C.)}}$$

(In this case, selected thermo-chiller model will be the HRW008-H.)

Precautions on Model Selection

1. Temperature difference between the circulating fluid and facility water

The HRW series exchanges heat between the circulating fluid and facility water directly, so it may not be possible to lower the circulating fluid temperature to the set temperature if the facility water temperature is too high. Check that the facility water temperature can be maintained for the circulating fluid temperature referring to the cooling capacity graph of each model before using.

2. Heating capacity

When setting the circulating fluid temperature at a higher temperature than the room temperature, the circulating fluid temperature will be heated with the thermo-chiller. Heating capacity varies depending on the circulating fluid temperature. Also, the heating capacity varies depending on the circulating fluid temperature. Consider the heat radiation amount or thermal capacity of the user's equipment. Check beforehand if the required heating capacity is provided, based on the heating capacity graph for the respective model.

3. Pump capacity

<Circulating fluid flow rate>

Pump capacity varies depending on the model selected from the HRW series. Also, circulating fluid flow varies depending on the circulating fluid discharge pressure. Consider the installation height difference between our thermo-chiller and a user's equipment, and the piping resistance such as circulating fluid pipings, or piping size, or piping curves in the machine. Check beforehand if the required flow rate is achieved, using the pump capacity curves for each respective model.

<Circulating fluid discharge pressure>

Circulating fluid discharge pressure has the possibility to increase up to the maximum pressure in the pump capacity curves for the respective model. Check beforehand if the circulating fluid pipings or circulating fluid circuit of the user's equipment are fully durable against this pressure.

Circulating Fluid Typical Physical Property Values

* Shown below are reference values.
Please contact circulating fluid supplier for details.

Fluorinated Fluids

Physical property value Temperature	Density γ	Specific heat C	
	[kg/m ³] [g/L]	[J/(kg·K)]	([kcal/kg·°C])
-10°C	1.87 x 10 ³	0.87 x 10 ³	0.21
20°C	1.80 x 10 ³	0.96 x 10 ³	0.23
50°C	1.74 x 10 ³	1.05 x 10 ³	0.25
80°C	1.67 x 10 ³	1.14 x 10 ³	0.27

60% Ethylene Glycol Aqueous Solution

Physical property value Temperature	Density γ	Specific heat C	
	[kg/m ³] [g/L]	[J/(kg·K)]	([kcal/kg·°C])
-10°C	1.10 x 10 ³	3.02 x 10 ³	0.72
20°C	1.08 x 10 ³	3.15 x 10 ³	0.75
50°C	1.06 x 10 ³	3.27 x 10 ³	0.78
80°C	1.04 x 10 ³	3.40 x 10 ³	0.81

Water

Density γ : 1 x 10³ [kg/m³] [g/L]

Specific heat C: 4.2 x 10³ [J/(kg·K)] (1.0 [kcal/kg·°C])

Thermo-chiller Fluorinated Fluid Type

HRW Series



How to Order

Fluorinated Fluid Type **HRW 002** - H -

Cooling capacity

Symbol	Cooling capacity
002	2 kW
008	8 kW
015	15 kW
030	30 kW

Temperature range setting

Symbol	Temperature range setting
H	20 to 90°C

Option

Symbol	Option
Nil	None
C	Analog communication
D	DeviceNet communication
N	NPT fitting
W	SI unit only
Z	Circulating fluid automatic recovery

Pump inverter control

Symbol	Pump inverter control
Nil	None
S	Applicable (Pump inverter type)

Specifications (For details, please refer to our "Product Specifications" information.)

Model	HRW002-H HRW002-HS	HRW008-H HRW008-HS	HRW015-H HRW015-HS	HRW030-H HRW030-HS		
Cooling method	Water-cooled					
Ambient temperature/humidity*1	Temperature: 10 to 35°C, Humidity: 30 to 70%RH					
Circulating fluid system	Circulating fluid*2	Fluorinert™ FC-40/GALDEN® HT200				
	Temperature range setting*1 °C	20 to 90				
	Conditions	Cooling capacity (50/60 Hz common) kW	2	8	15	29
		Circulating fluid temperature °C	Facility water temperature +15			
		Facility water temperature °C	10 to 35			
		Circulating fluid rated flow L/min	4	30	40	40
		Facility water required flow rate L/min	10	20	25	40
	Temperature stability*3 °C	±0.3				
	Pump capacity (50/60 Hz)*4 MPa	0.40/0.60 (at 4 L/min)	0.45/0.65 (at 30 L/min)	0.40/0.60 (at 40 L/min)	0.40/0.60 (at 40 L/min)	
	Circulating fluid flow range*5 L/min	3 to 16		9 to 50		
Tank capacity*6 L	Approx. 13		Approx. 14			
Circulating fluid recovery tank volume*7 L	12					
Port size	Rc3/4					
Fluid contact material	Copper brazing (Heat exchanger), Stainless steel, EPDM, Silicone, PPS, Fluoro-resin					
Facility water system	Temperature range °C	10 to 35				
	Required flow rate*8 L/min	10	20	25	40	
	Inlet pressure range MPa	0.3 to 0.7				
	Port size	Rc3/4				
Fluid contact material	Copper brazing (Heat exchanger), Stainless steel, EPDM, Silicone, Bronze, Brass, NBR					
Electrical system	Power supply	3-phase 200/200 to 208 VAC ±10%				
	Max. operating current A	26				
	Breaker capacity A	30				
	Communications	Serial RS-485 (D-sub 9 pin) and Contact input/output (D-sub 25 pin)				
Dimensions*9 mm	W380 x D665 x H860					
Weight*10 kg	HRW□□□-H	Approx. 90		Approx. 100		
	HRW□□□-HS	Approx. 95		Approx. 105		
Safety standards	UL, CE/UKCA marking, SEMI (S2-0703, S8-1103, F47-0200), SEMATECH (S2-93, S8-95)					

*1 No condensation should be present.
 *2 GALDEN® is a registered trademark, belonging to the Solvay Group or its corresponding owner. Fluorinert™ is a trademark of 3M. Regarding the fluid other than the above, please contact SMC.
 *3 Temperature at the thermo-chiller outlet when the circulating fluid and facility water are at the rated flow and the circulating fluid outlet and return port are directly connected. The installation environment, power supply, and facility water are within the specification range and stable. Value obtained 10 minutes after the external load is stabilized. It may be out of ±0.3°C in some other operating conditions.
 *4 The capacity at the circulating fluid outlet when the circulating fluid temperature is 20°C. Pump capacity at 60 Hz indicates the maximum capacity of the HRW□□□-HS (pump inverter type).
 *5 Applicable to the HRW□□□-HS (pump inverter type) only. May not be able to control with the set value depending on the piping specification in the user side.
 *6 Minimum volume required for operating only the thermo-chiller. (Circulating fluid temperature: 20°C, including the thermo-chiller's internal pipings or heat exchanger)
 *7 The automatic circulating fluid recovering function will be provided by selecting option Z for collecting the circulating fluid inside an external piping.
 *8 The flow rate required to achieve the cooling capacity and temperature stability described above. The actual facility water flow rate will vary depending on the operating conditions.
 *9 Panel dimensions. These dimensions do not include possible protrusions such as a breaker handle.
 *10 Weight in the dry state without circulating fluids

Cooling Capacity

HRW002-H/008-H/015-H/030-H
HRW002-HS/008-HS/015-HS/030-HS

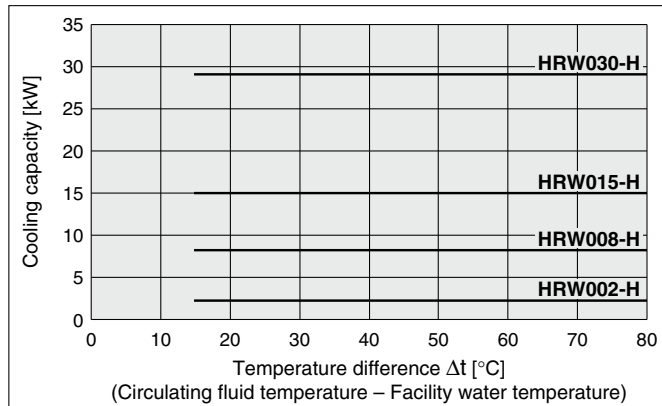

Heating Capacity

HRW002-H/008-H/015-H/030-H
HRW002-HS/008-HS/015-HS/030-HS

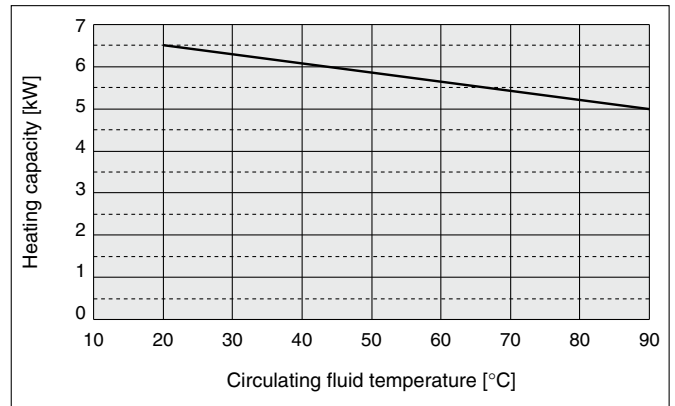

* When pump inverter is operating at frequency of 60 Hz (maximum).

Pump Capacity

HRW002-H
HRW002-HS

Circulating fluid: Fluorinated fluids
Circulating fluid temperature: 20°C

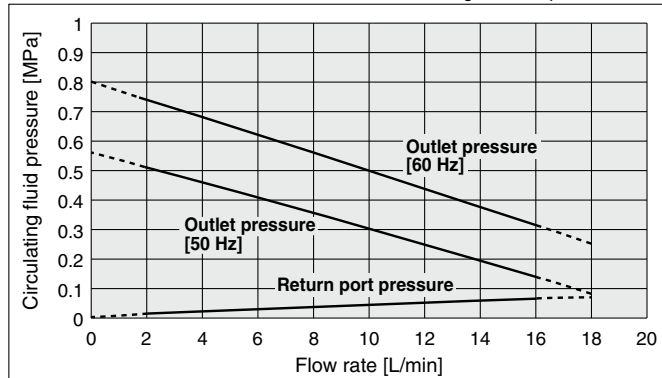

- * If the circulating fluid flow drops below 2 L/min., the shutdown alarm activates and operation stops. Do not use the product when the flow exceeds 16 L/min., since the flow cannot be displayed accurately.
- * Pump capacity at 60 Hz indicates the maximum capacity of the HRW002-HS (pump inverter type).

HRW008-H/015-H/030-H
HRW008-HS/015-HS/030-HS

Circulating fluid: Fluorinated fluids
Circulating fluid temperature: 20°C

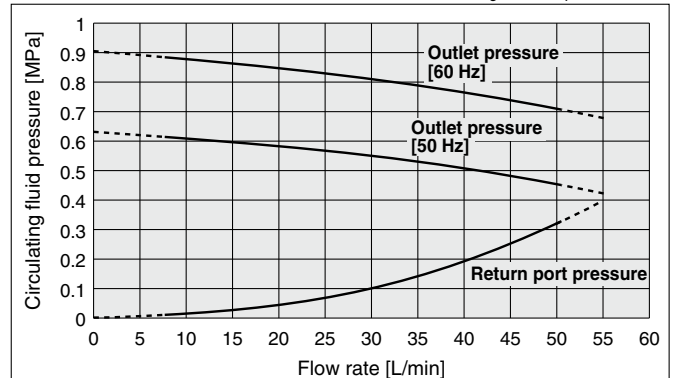

- * If the circulating fluid flow drops below 8 L/min., the shutdown alarm activates and operation stops. Do not use the product when the flow exceeds 50 L/min., since the flow cannot be displayed accurately.
- * Pump capacity at 60 Hz indicates the maximum capacity of the HRW008-HS/015-HS/030-HS (pump inverter type).

Thermo-chiller Ethylene Glycol Type

HRW Series



How to Order

Ethylene Glycol Type **HRW 002 - H 1** - [] - []

Cooling capacity

Symbol	Cooling capacity
002	2 kW
008	8 kW
015	15 kW
030	30 kW

Temperature range setting

Symbol	Temperature range setting
H	20 to 90°C

Option

Symbol	Option
Nil	None
C	Analog communication
D	DeviceNet communication
N	NPT fitting
W	SI unit only
Y	DI control kit
Z	Circulating fluid automatic recovery

Ethylene glycol type

Pump inverter control

Symbol	Pump inverter control
Nil	None
S	Applicable (Pump inverter type)

Specifications (For details, please refer to our "Product Specifications" information.)

Model	HRW002-H1 HRW002-H1S	HRW008-H1 HRW008-H1S	HRW015-H1 HRW015-H1S	HRW030-H1 HRW030-H1S	
Cooling method	Water-cooled				
Ambient temperature/humidity*1	Temperature: 10 to 35°C, Humidity: 30 to 70%RH				
Circulating fluid system	Circulating fluid*2	60% ethylene glycol aqueous solution			
	Temperature range setting*1 °C	20 to 90			
	Cooling capacity (50/60 Hz common) kW	2	8	15	27
	Conditions	Circulating fluid temperature °C	Facility water temperature +15		
		Facility water temperature °C	10 to 35		
		Circulating fluid rated flow L/min	4	15	30
	Facility water required flow rate L/min	10	15	25	40
	Temperature stability*3 °C	±0.3			
	Pump capacity (50/60 Hz)*4 MPa	0.35/0.55 (at 4 L/min)	0.45/0.65 (at 15 L/min)	0.40/0.60 (at 30 L/min)	0.35/0.55 (at 40 L/min)
	Circulating fluid flow range*5 L/min	3 to 16	9 to 50		
Tank capacity*6 L	Approx. 13				
Circulating fluid recovery tank volume*7 L	12				
Port size	Rc3/4				
Fluid contact material	Nickel brazing (Heat exchanger), Stainless steel, EPDM, Silicone, PPS, Fluororesin				
Facility water system	Temperature range °C	10 to 35			
	Required flow rate*8 L/min	10	15	25	40
	Inlet pressure range MPa	0.3 to 0.7			
	Port size	Rc3/4			
Fluid contact material	Nickel brazing (Heat exchanger), Stainless steel, EPDM, Silicone, Bronze, Brass, NBR				
Electrical system	Power supply	3-phase 200/200 to 208 VAC ±10%			
	Max. operating current A	26			
	Breaker capacity A	30			
	Communications	Serial RS-485 (D-sub 9 pin) and Contact input/output (D-sub 25 pin)			
Dimensions*9 mm	W380 x D665 x H860				
Weight*10 kg	HRW□□□-H1	Approx. 90			
	HRW□□□-H1S	Approx. 95			
Safety standards	UL, CE/UKCA marking, SEMI (S2-0703, S8-1103, F47-0200), SEMATECH (S2-93, S8-95)				

*1 No condensation should be present.
 *2 Dilute pure ethylene glycol with tap water. Additives invading fluid contact material such as preservatives cannot be used.
 *3 Temperature at the thermo-chiller outlet when the circulating fluid and facility water are at the rated flow and the circulating fluid outlet and return port are directly connected. The installation environment, power supply, and facility water are within the specification range and stable. Value obtained 10 minutes after the external load is stabilized (after stabilization with no load for HRW030-H1). It may be out of this range when a DI control kit (option Y) is used or in some other operating conditions.
 *4 The capacity at the circulating fluid outlet when the circulating fluid temperature is 20°C. Pump capacity at 60 Hz indicates the maximum capacity of the HRW□□□-H1S (pump inverter type).
 *5 Applicable to the HRW□□□-H1S (pump inverter type) only. May not be able to control with the set value depending on the piping specification in the user side.
 *6 Minimum volume required for operating only the thermo-chiller. (Circulating fluid temperature: 20°C, including the thermo-chiller's internal pipings or heat exchanger)
 *7 The automatic circulating fluid recovering function will be provided by selecting option Z for collecting the circulating fluid inside an external piping.
 *8 The flow rate required to achieve the cooling capacity and temperature stability described above. The actual facility water flow rate will vary depending on the operating conditions.
 *9 Panel dimensions. These dimensions do not include possible protrusions such as a breaker handle.
 *10 Weight in the dry state without circulating fluids



Cooling Capacity

HRW002-H1/008-H1/015-H1/030-H1
HRW002-H1S/008-H1S/015-H1S/030-H1S

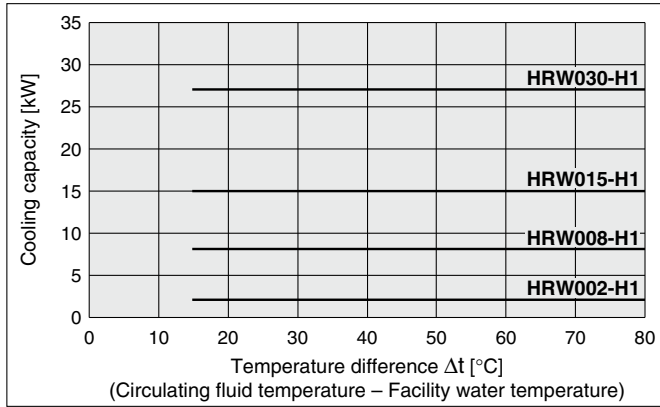

Heating Capacity

HRW002-H1/008-H1/015-H1/030-H1
HRW002-H1S/008-H1S/015-H1S/030-H1S

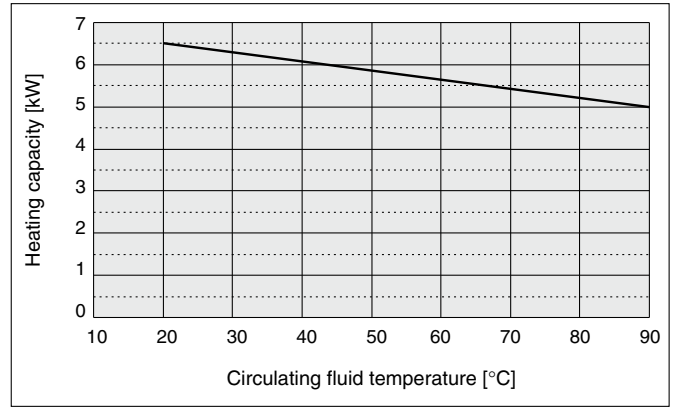

* When pump inverter is operating at frequency of 60 Hz (maximum).

Pump Capacity

HRW002-H1
HRW002-H1S

Circulating fluid: 60% ethylene glycol
Circulating fluid temperature: 20°C

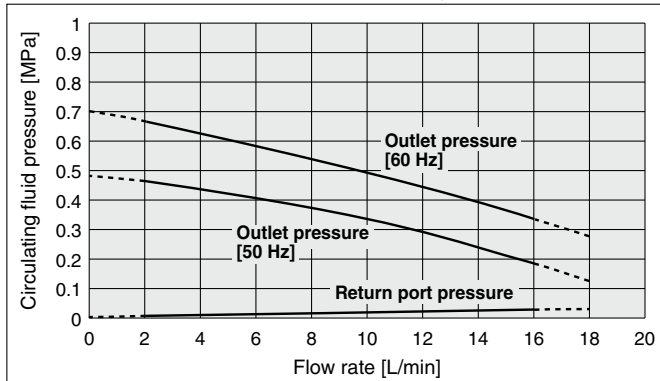

- * If the circulating fluid flow drops below 2 L/min., the shutdown alarm activates and operation stops. Do not use the product when the flow exceeds 16 L/min., since the flow cannot be displayed accurately.
- * Pump capacity at 60 Hz indicates the maximum capacity of the HRW002-H1S (pump inverter type).

HRW008-H1/015-H1/030-H1
HRW008-H1S/015-H1S/030-H1S

Circulating fluid: 60% ethylene glycol
Circulating fluid temperature: 20°C

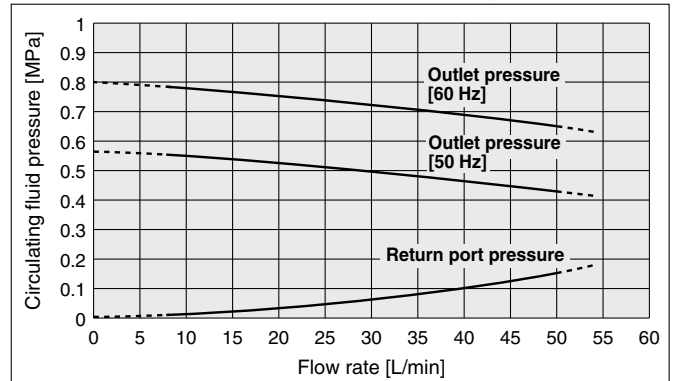

- * If the circulating fluid flow drops below 8 L/min., the shutdown alarm activates and operation stops. Do not use the product when the flow exceeds 50 L/min., since the flow cannot be displayed accurately.
- * Pump capacity at 60 Hz indicates the maximum capacity of the HRW008-H1S/015-H1S/030-H1S (pump inverter type).

Thermo-chiller Tap/Deionized Water Type

HRW Series



How to Order

Tap/Deionized Water Type

HRW 002 - H 2 -

Cooling capacity

Symbol	Cooling capacity
002	2 kW
008	8 kW
015	15 kW
030	30 kW

Temperature range setting

Symbol	Temperature range setting
H	20 to 90°C

Tap/Deionized water type

Option

Symbol	Option
Nil	None
C	Analog communication
D	DeviceNet communication
N	NPT fitting
W	SI unit only
Y	DI control kit
Z	Circulating fluid automatic recovery

Pump inverter control

Symbol	Pump inverter control
Nil	None
S	Applicable (Pump inverter type)

Specifications (For details, please refer to our "Product Specifications" information.)

Model		HRW002-H2 HRW002-H2S	HRW008-H2 HRW008-H2S	HRW015-H2 HRW015-H2S	HRW030-H2 HRW030-H2S	
Cooling method		Water-cooled				
Ambient temperature/humidity *1		Temperature: 10 to 35°C, Humidity: 30 to 70%RH				
Circulating fluid system	Circulating fluid *2	Tap water, Deionized water				
	Temperature range setting *1 °C	20 to 90				
	Cooling capacity (50/60 Hz common) kW	2	8	15	30	
	Conditions	Circulating fluid temperature °C	Facility water temperature +15			
		Facility water temperature °C	10 to 35			
		Circulating fluid rated flow L/min	4	15	30	40
		Facility water required flow rate L/min	10	15	25	40
	Temperature stability *3 °C	±0.3				
	Pump capacity (50/60 Hz) *4 MPa	0.35/0.55 (at 4 L/min)	0.45/0.65 (at 15 L/min)	0.40/0.60 (at 30 L/min)	0.35/0.55 (at 40 L/min)	
	Circulating fluid flow range *5 L/min	3 to 16		9 to 50		
Tank capacity *6 L	Approx. 13					
Circulating fluid recovery tank volume *7 L	12					
Facility water system	Port size	Rc3/4				
	Fluid contact material	Nickel brazing (Heat exchanger), Stainless steel, EPDM, Silicone, PPS, Fluororesin				
	Temperature range °C	10 to 35				
	Required flow rate *8 L/min	10	15	25	40	
	Inlet pressure range MPa	0.3 to 0.7				
Electrical system	Port size	Rc3/4				
	Fluid contact material	Nickel brazing (Heat exchanger), Stainless steel, EPDM, Silicone, Bronze, Brass, NBR				
	Power supply	3-phase 200/200 to 208 VAC ±10%				
	Max. operating current A	26				
Breaker capacity A	30					
Communications	Serial RS-485 (D-sub 9 pin) and Contact input/output (D-sub 25 pin)					
Dimensions *9 mm	W380 x D665 x H860					
Weight *10 kg	HRW□□□-H2	Approx. 90				
	HRW□□□-H2S	Approx. 95				
Safety standards	UL, CE/UKCa marking, SEMI (S2-0703, S8-1103, F47-0200), SEMATECH (S2-93, S8-95)					

*1 No condensation should be present.
 *2 If tap water or deionized water is used, use water that is compliant with the Water Quality Standards of the Japan Refrigeration and Air Conditioning Industry Association (JRA GL-02-1994/cooling water system - circulation type - make-up water). The electric conductivity of the deionized water used as the fluid varies depending on the operating conditions.
 *3 Temperature at the thermo-chiller outlet when the circulating fluid and facility water are at the rated flow and the circulating fluid outlet and return port are directly connected. The installation environment, power supply, and facility water are within the specification range and stable. Value obtained 10 minutes after the external load is stabilized (after stabilization with no load for HRW030-H2). It may be out of this range when a DI control kit (option Y) is used or in some other operating conditions.
 *4 The capacity at the circulating fluid outlet when the circulating fluid temperature is 20°C. Pump capacity at 60 Hz indicates the maximum capacity of the HRW□□□-H2S (pump inverter type).
 *5 Applicable to the HRW□□□-H2S (pump inverter type) only. May not be able to control with the set value depending on the piping specification in the user side.
 *6 Minimum volume required for operating only the thermo-chiller. (Circulating fluid temperature: 20°C, including the thermo-chiller's internal pipings or heat exchanger)
 *7 The automatic circulating fluid recovering function will be provided by selecting option Z for collecting the circulating fluid inside an external piping.
 *8 The flow rate required to achieve the cooling capacity and temperature stability described above. The actual facility water flow rate will vary depending on the operating conditions.
 *9 Panel dimensions. These dimensions do not include possible protrusions such as a breaker handle.
 *10 Weight in the dry state without circulating fluids

Cooling Capacity

HRW002-H2/008-H2/015-H2/030-H2
HRW002-H2S/008-H2S/015-H2S/030-H2S

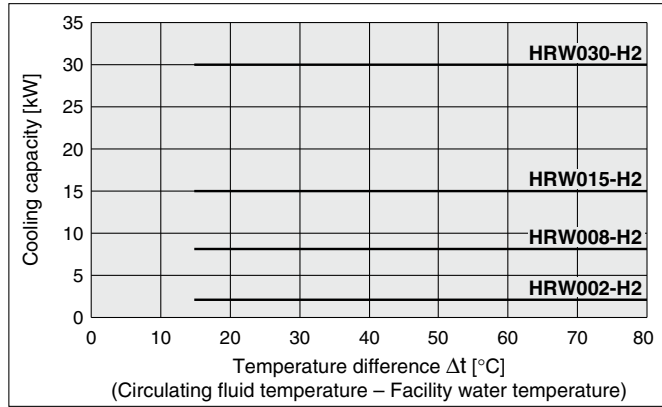

Heating Capacity

HRW002-H2/008-H2/015-H2/030-H2
HRW002-H2S/008-H2S/015-H2S/030-H2S

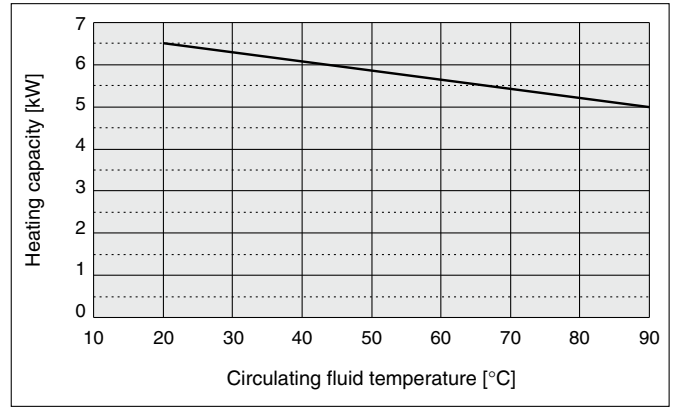

* When pump inverter is operating at frequency of 60 Hz (maximum).

Pump Capacity

HRW002-H2
HRW002-H2S

Circulating fluid: Tap water
Circulating fluid temperature: 20°C

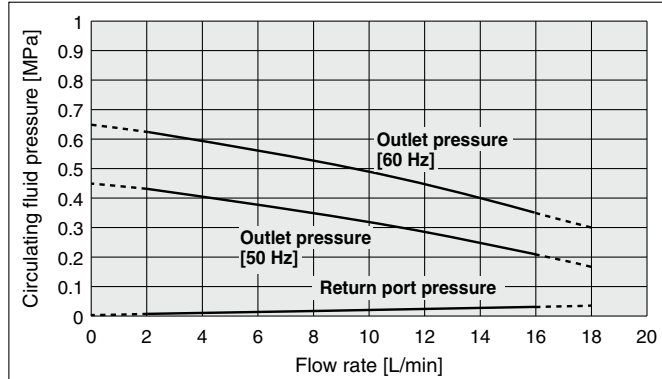

- * If the circulating fluid flow drops below 2 L/min., the shutdown alarm activates and operation stops. Do not use the product when the flow exceeds 16 L/min., since the flow cannot be displayed accurately.
- * Pump capacity at 60 Hz indicates the maximum capacity of the HRW002-H2S (pump inverter type).

HRW008-H2/015-H2/030-H2
HRW008-H2S/015-H2S/030-H2S

Circulating fluid: Tap water
Circulating fluid temperature: 20°C

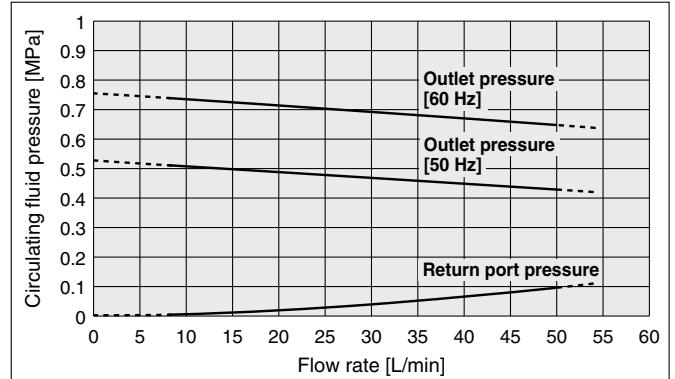

- * If the circulating fluid flow drops below 8 L/min., the shutdown alarm activates and operation stops. Do not use the product when the flow exceeds 50 L/min., since the flow cannot be displayed accurately.
- * Pump capacity at 60 Hz indicates the maximum capacity of the HRW008-H2S/015-H2S/030-H2S (pump inverter type).

HRW Series

Common Specifications

Dimensions

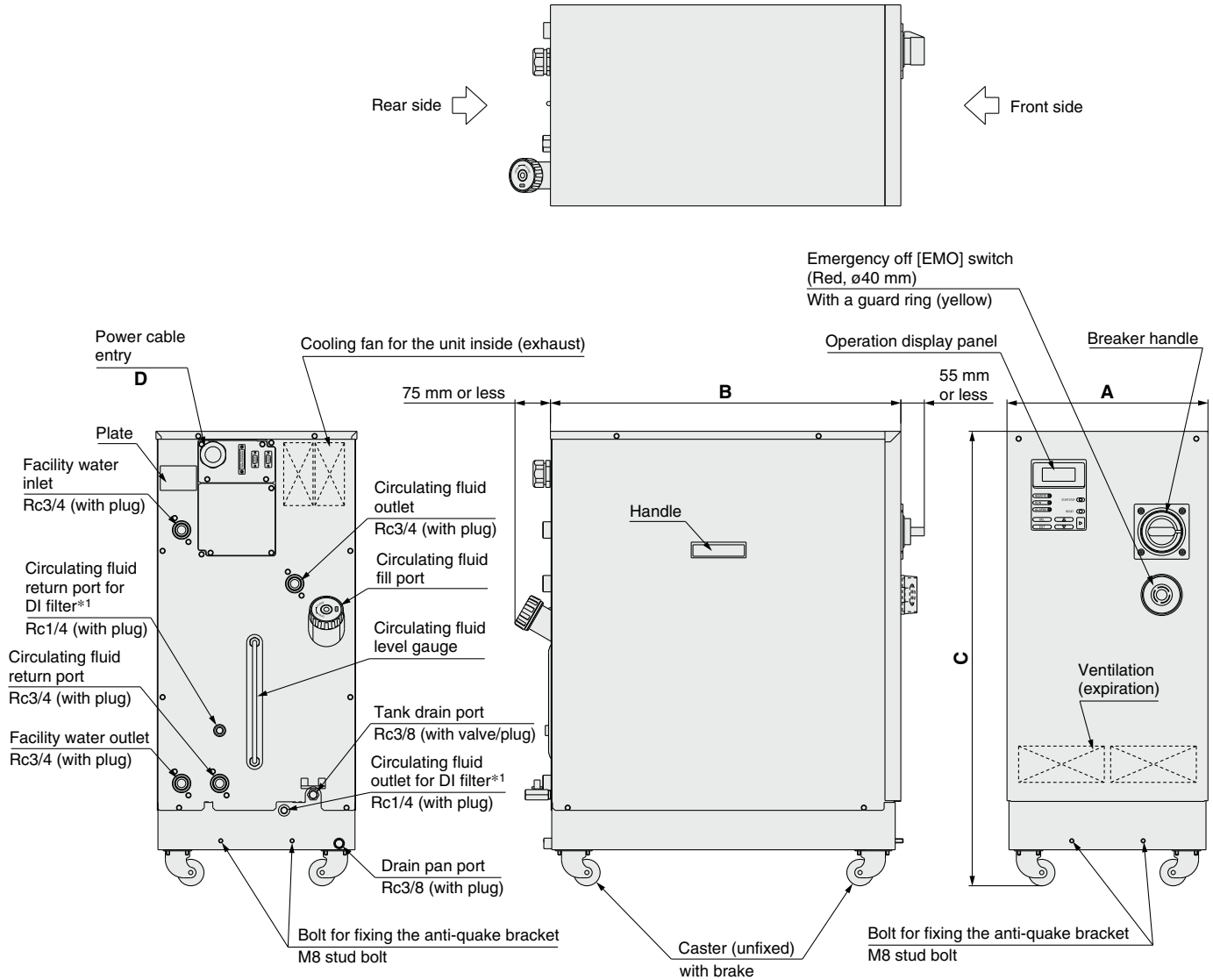

*1 Only when the DI control kit (option Y) is selected.

Model			[mm]			
Fluorinated fluid type	Ethylene glycol type	Tap/Deionized water type	A	B	C	D
HRW002-H	HRW002-H1	HRW002-H2	380	665	860	ø18.5 to 20.5
HRW008-H	HRW008-H1	HRW008-H2				
HRW015-H	HRW015-H1	HRW015-H2				
HRW030-H	HRW030-H1	HRW030-H2				

Communication Functions (For details, please refer to our "Communication Specifications" information.)

Contact Input/Output

Item	Specifications	
Connector no.	P1	
Connector type (on this product's side)	D-sub 25 P type, Female connector	
Fixing bolt size	M2.6 x 0.45	
Input signal	Insulation method	Photocoupler
	Rated input voltage	24 VDC
	Operating voltage range	21.6 to 26.4 VDC
	Rated input current	5 mA TYP
	Input impedance	4.7 kΩ
Output signal	Rated load voltage	48 VAC or less/30 VDC or less
	Maximum load current (total)	When using the power supply of the Thermo-chiller: 200 mA DC (Resistance load/Inductive load) When using the power supply of the user's equipment: 800 mA AC/DC (Resistance load/Inductive load)
Alarm signal	Rated load voltage	48 VAC or less/30 VDC or less
	Maximum load current	800 mA AC/DC (Resistance load/Inductive load)
EMO signal	Rated load voltage	48 VAC or less/30 VDC or less
	Maximum load current	800 mA AC/DC (Resistance load/Inductive load)

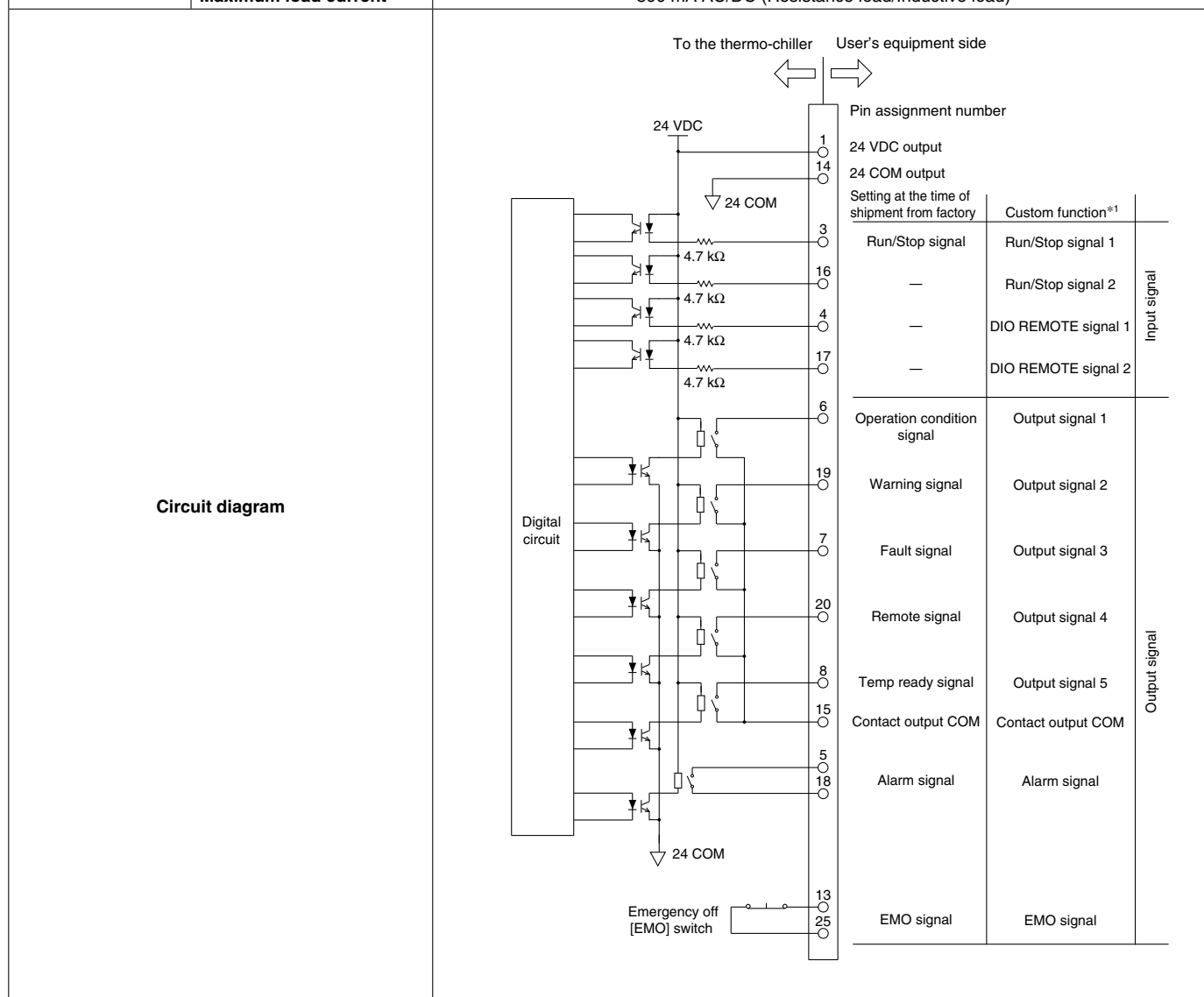

*1 The custom function is equipped for contact input/output. Using the custom function enables the user to set the signal type for contact input/output or pin assignment numbers. For details, please refer to the "Communication Specifications" information.

HRW Series

Communication Functions (For details, please refer to our "Communication Specifications" information.)

Serial RS-485

The serial RS-485 enables the following items to be written and read out.

<Writing>

Run/Stop

Circulating fluid temperature setting

Circulating fluid automatic recovery start/stop*¹

<Readout>

Circulating fluid present temperature

Circulating fluid flow

Circulating fluid discharge pressure

Circulating fluid electric resistivity*²

Alarm occurrence information

Status (operating condition) information

*1 Only when the circulating fluid automatic recovery function (option Z) is selected.

*2 Only when the DI control kit (option Y) is selected.

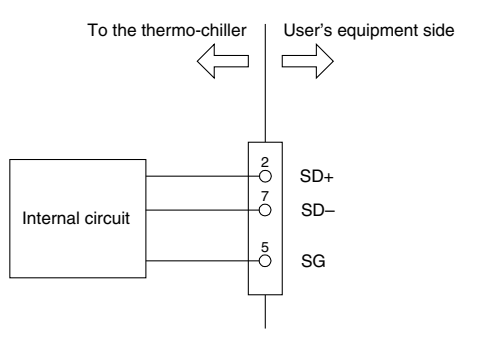
Item	Specifications
Connector no.	P2
Connector type (on this product's side)	D-sub 9 P type, Female connector
Fixing bolt size	M2.6 x 0.45
Standards	EIA RS485
Protocol	Modicon Modbus
Circuit diagram	

Connector Location

P3: Not used for the maintenance purpose port
D-sub 9 (Male receptacle)

P2: Serial RS-485
D-sub 9 (Female receptacle)

P1: Contact input/output
D-sub 25 (Female receptacle)

Power cable entry

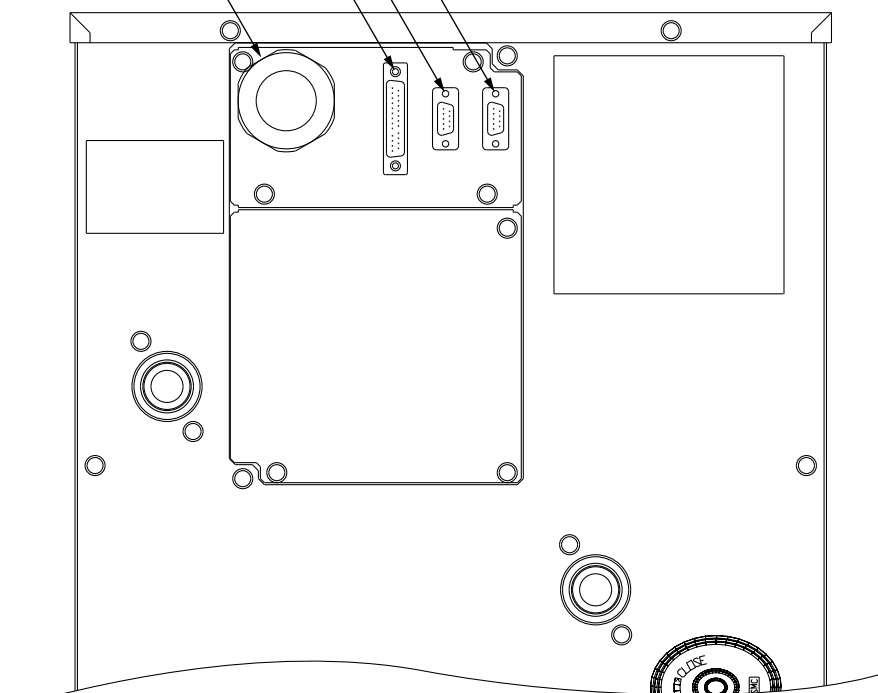

Rear side

Operation Display Panel

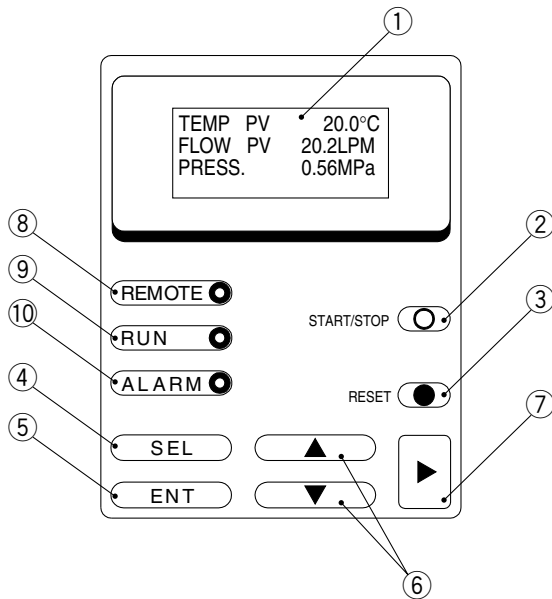

No.	Description	Function
①	LCD	Operating condition of this unit/Circulating fluid discharge temperature/Circulating fluid flow/Circulating fluid discharge pressure/Setting value/Alarm message, etc. are displayed.
②	[START/STOP] key	Starts/Stops the operation.
③	[RESET] key	Stops the alarm buzzing. Resets the alarm.
④	[SEL] key	Switches the display.
⑤	[ENT] key	Decides the settings.
⑥	[▲] [▼] key	Moves the cursor and changes the setting values.
⑦	[▶] key	Moves the cursor.
⑧	[REMOTE] lamp	Lights up when the unit is in the remote status.
⑨	[RUN] lamp	Lights up when the unit is in the operating status.
⑩	[ALARM] lamp	Lights up when the unit is alarming.

Alarm

This unit can display 23 kinds of alarm messages as standard. Also, it can read out the serial RS-485 communication.

Alarm code	Alarm message	Operation status	Main reason
01	Water Leak Detect FLT	Stop	Liquid deposits in the drain pan of this unit.
02	Incorrect Phase Error FLT	Stop	The power supply to this unit is incorrect.
05	Reservoir Low Level FLT	Stop	The amount of circulating fluid tank is running low.
06	Reservoir Low Level WRN	Continue	The amount of circulating fluid tank is running low.
07	Reservoir High Level WRN	Continue	The amount of circulating fluid in the tank has increased.
08	Temp. Fuse Cutout FLT	Stop	Temperature of the circulating fluid tank is raised.
09	Reservoir High Temp. FLT	Stop	Temperature of the circulating fluid has exceeded the limitation.
10	Return High Temp. WRN	Continue	Temperature of returning circulating fluid has exceeded the limit.
11	Reservoir High Temp. WRN	Continue	Temperature of the circulating fluid has exceeded the limitation set by user.
12	Return Low Flow FLT	Stop	The circulating fluid flow has gone below the limit.
13	Return Low Flow WRN	Continue	Flow rate of the Thermo-chiller has dropped below the set value.
15	Pump Breaker Trip FLT	Stop	The protective equipment in the circulating fluid driving line has started.
17	Interlock Fuse Cutout FLT	Stop	Overcurrent is flown to the control circuit.
18	DC Power Fuse Cutout WRN	Continue	Overcurrent has flowed to the (optional) solenoid valve. (Only for the automatic circulating fluid recovery function - option Z)
19	FAN Motor Stop WRN	Continue	Cooling fan inside the compressor has stopped.
21	Controller Error FLT	Stop	The error occurred in the control systems.
22	Memory Data Error FLT	Stop	The data stored in the controller of this unit went wrong.
23	Communication Error WRN	Continue	The serial communications between this unit and user's system has been suspended.
24	DI Low Level WRN	Continue	DI level of the circulating fluid has gone below the limitation set by user. (Only for DI control kit - option Y)
25	Pump Inverter Error FLT	Stop	The error occurred in the circulating pump inverter. This alarm is applicable to the HRW□□□-H□S only.
26	DNET Comm. Error FLT	Stop	The DeviceNet communications between this unit and user's system has been suspended. (Only for DeviceNet communication specification - option D)
27	DNET Comm. Error WRN	Continue	An error has occurred in the DeviceNet communication system of this unit. (Only for DeviceNet communication specification - option D)
29	F.Water Low Temp. WRN	Continue	Temperature of facility water has dropped below the set temperature.
30	F.Water High Temp. WRN	Continue	Temperature of facility water has exceeded the set temperature.

HRW Series Options

* Options have to be selected when ordering the thermo-chiller. It is not possible to add them after purchasing the unit.

C Option symbol Analog Communication

HRW - - - C
Analog communication

In addition to the standard contact input/output signal communication and the serial RS-485 communication, analog communication function can be added.

The analog communication function enables to write and read out the following items.

<Writing>	<Readout>
Circulating fluid temperature setting	Circulating fluid present temperature
	Electric resistivity* ¹

*¹ Only when the DI control kit (option Y) is selected.

Scaling voltage - circulating fluid temperature can be set arbitrarily by user.

For details, please refer to our "Communication Specifications" information.

D Option symbol DeviceNet Communication

HRW - - - D
DeviceNet communication

DeviceNet[®]
■ Trademark
DeviceNet[®] is a registered trademark of ODVA, Inc.

In addition to the standard contact input/output signal communication and the serial RS-485 communication, DeviceNet function can be added. DeviceNet function enables to write and read out the following items.

<Writing>	<Readout>
Run/Stop	Circulating fluid present temperature
Circulating fluid temperature setting	Circulating fluid flow
Circulating fluid automatic recovery start/stop* ¹	Circulating fluid discharge pressure
	Electric resistivity* ²
	Alarm occurrence information
	Status (operating condition) information

*¹ Only when the circulating fluid automatic recovery function (option Z) is selected.

*² Only when the DI control kit (option Y) is selected.

For details, please refer to our "Communication Specifications" information.

N Option symbol NPT Fitting

HRW - - - N
NPT fitting

An adapter is included to change the connection parts of circulating fluid piping and facility water piping to NPT thread type. The adapter must be installed by user.

W Option symbol SI Unit Only

HRW - - - W
SI unit only

The circulating fluid temperature and pressure are displayed in SI units [MPa/°C] only. If this option is not selected, a product with a unit selection function will be provided by default.
* No change in external dimensions

Y Option symbol DI Control Kit

HRW - - - Y
DI control kit

Select this option if you want to maintain the electric resistivity (DI level) of the circulating fluid at a certain level. However, some components have to be fitted user. For details, refer to specification table for this option.

Please note that this is not applicable to the fluorinated liquid type.

Applicable model		HRW0 <input type="text"/> -H1-Y	HRW0 <input type="text"/> -H2-Y
Allowable circulating fluid	—	60% ethylene glycol aqueous solution	Deionized water
DI level display range	MΩ·cm	0 to 20	
DI level set range	MΩ·cm	0 to 20* ¹	
Solenoid valve hysteresis for control	MΩ·cm	0 to 0.9	
DI level reduction alarm set range	MΩ·cm	0 to 20	

*¹ The DI filter is needed to control the DI level. (SMC Part No.: HRZ-DF001)
Please purchase additionally because the DI filter is not included in this option. Also, if necessary, additionally purchase the insulating material for the DI filter. (SMC Part No.: HRZ-DF002)

- * Install the DI filter outside the thermo-chiller for piping. Secure the space for installing the DI filter in the rear side of the thermo-chiller.
- * It may go outside of the temperature stability range of ±0.3°C when this option is used in some operating conditions.

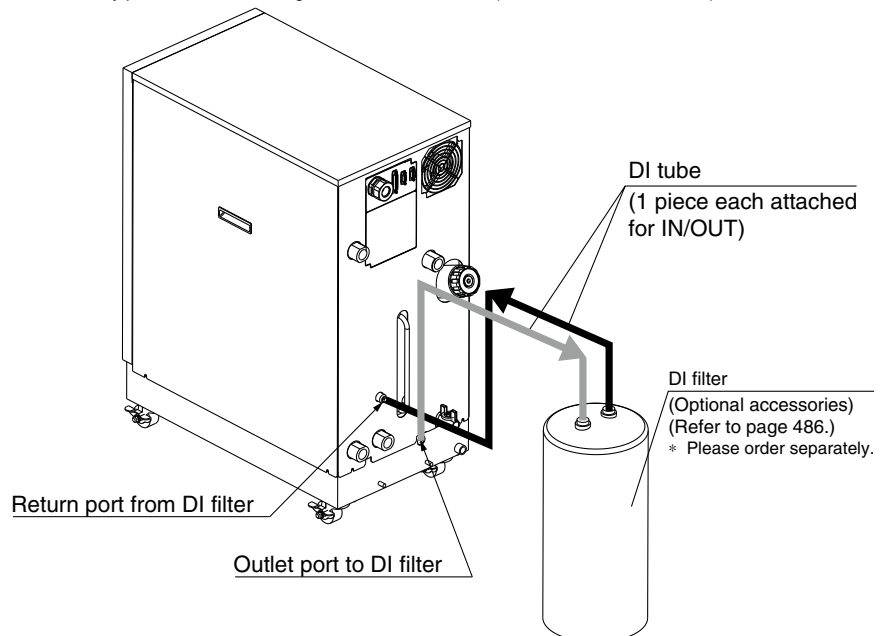

Z Option symbol

Circulating Fluid Automatic Recovery

HRW - - - **Z**

●
Circulating fluid
automatic recovery

Select this option for users who want to use the circulating fluid automatic recovery function.

The automatic recovery function is a device which can recover the circulating fluid inside pipings into a sub-tank of the thermo-chiller by the external communication or operation display panel.

Some components need to be fitted by user. For details, consult "Product Specifications" information for these options.

Applicable model		Common for all models
Circulating fluid recoverable volume* ¹	L	12
Purge gas	—	Nitrogen gas
Purge gas supply port	—	Self-align fitting for O.D. ø8* ²
Purge gas supply pressure	MPa	0.4 to 0.7
Purge gas filtration	μm	0.01 or less
Regulator set pressure	MPa	0.15 to 0.3* ³
Recoverable circulating fluid temperature	°C	10 to 40
Recovery start/stop	—	Start: External communication* ⁴ or operation display panel/Stop: Automatic
Timeout error	sec	Timer from recovery start to completion Stops recovering when the timer turns to set time. Possible set range: 60 to 300, at the time of shipping from the factory: 300
Height difference with the user system side	m	10 or less

*¹ This is the space volume of the sub-tank when the liquid level of the circulating fluid is within the specification. Guideline of the recovery volume is 80% of the circulating fluid recoverable volume.

*² Before piping, clean inside the pipings with air blow, etc. Use the piping with no dust generation by purge gas. When using resin tube, where necessary, use insert fittings, etc. in order not to deform the tubings when connecting to self-align fittings.

*³ At the time of shipping from factory, it is set to 0.2 MPa.

*⁴ For details, please refer to our "Communication Specifications" information.

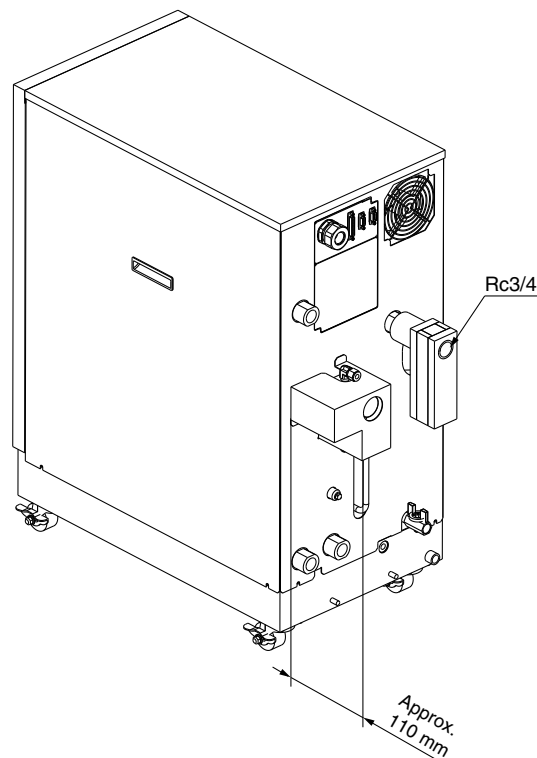

HRW Series Optional Accessories

* Necessary to be fitted by user.

① Bypass Piping Set

When the circulating fluid goes below the rated flow, cooling capacity will be reduced and the temperature stability will be badly affected. In such a case, use the bypass piping set.

Part no.	Applicable model
HRW-BP001	Common for all models

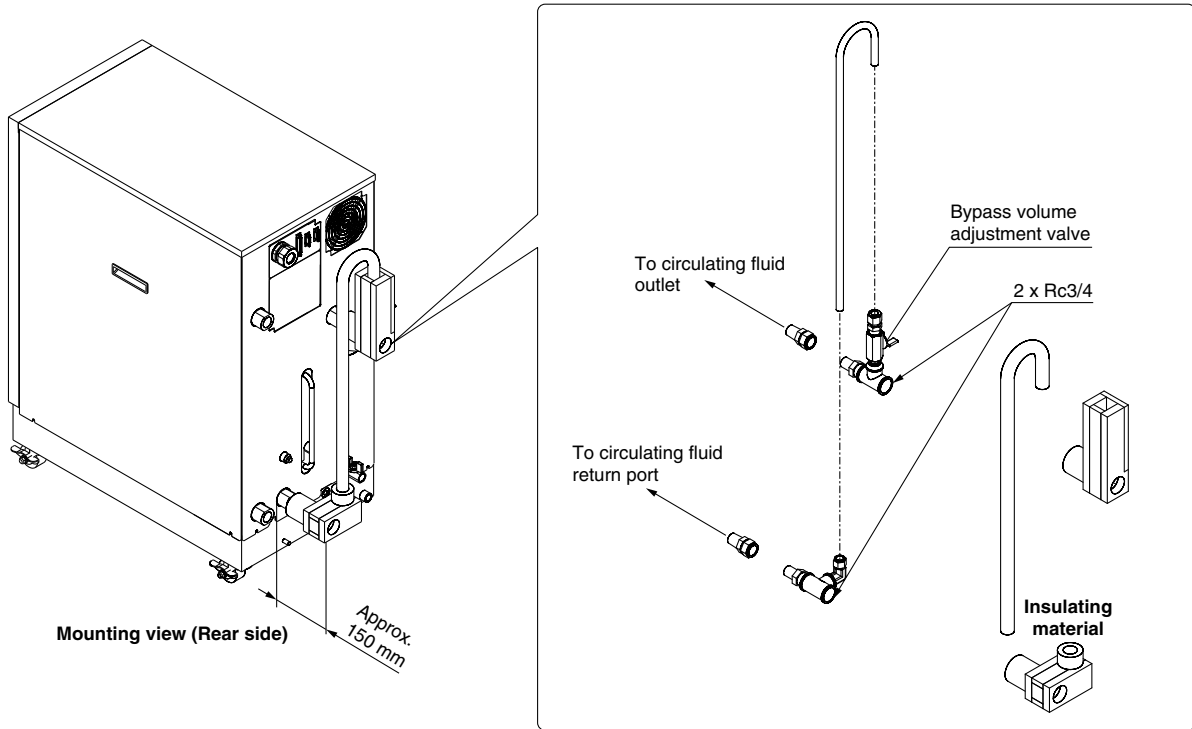

② Anti-quake Bracket

Bracket for earthquakes
Prepare the anchor bolts (M12) which are suited to the floor material by user.

Part no.	Applicable model
HRZ-TK002	Common for all models

* 2 pieces per set (for 1 unit) (HRZ-TK002)

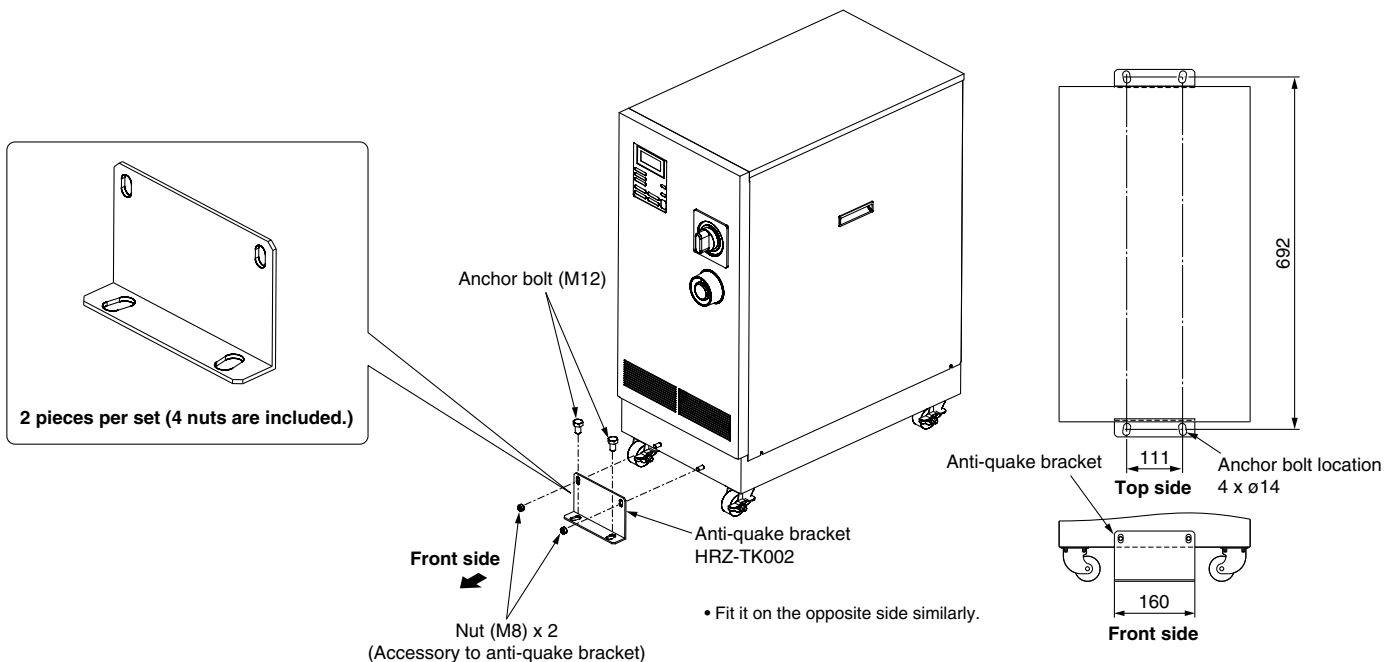

③ 4-Port Manifold

4-branching the circulating fluid enables 4 temperature controls at the maximum with the 1 unit thermo-chiller. Order the heat insulator for 4 port manifold (HRW-MA002) separately if necessary.

Part no.	Applicable model
HRW-MA001	Common for all models
HRW-MA002	

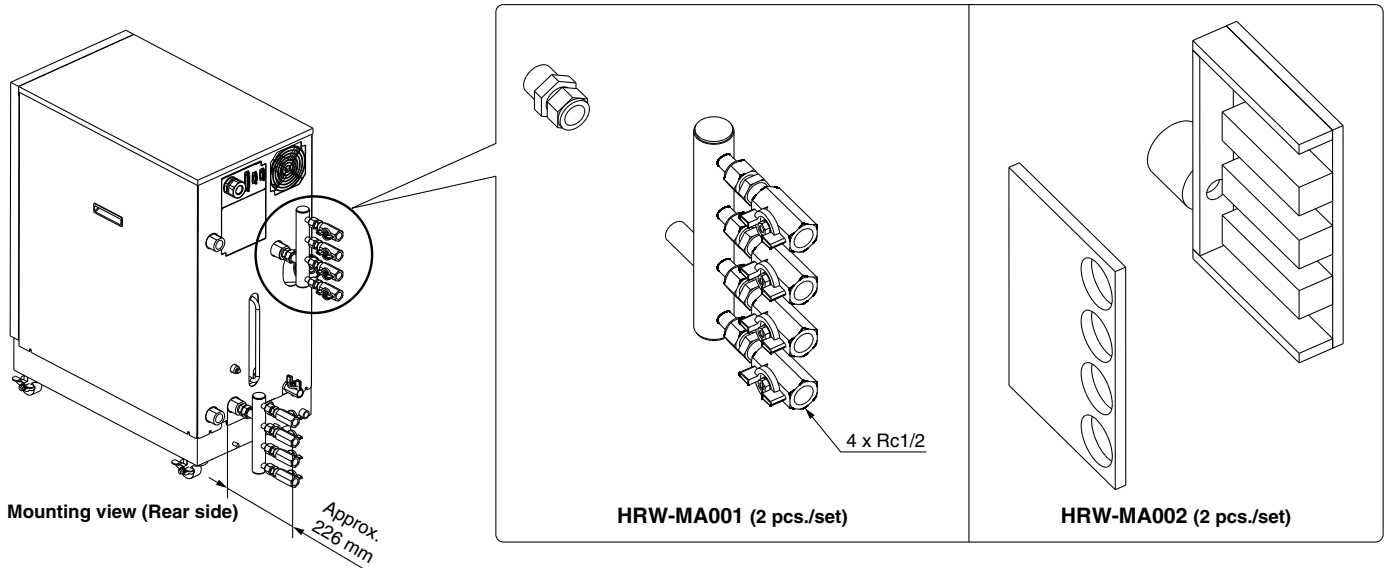

④ DI Filter

This is the ion replacement resin to maintain the electric resistivity of the circulating fluid. Users who selected the DI control kit (option Y) need to purchase the DI filter separately.

Part no.	Applicable model
HRZ-DF001	Common for all models which can select the DI control kit. (option Y)

* The DI filters are consumable. Depending on the status (electric resistivity set value, circulating fluid temperature, piping volume, etc.), product life cycles will vary accordingly.

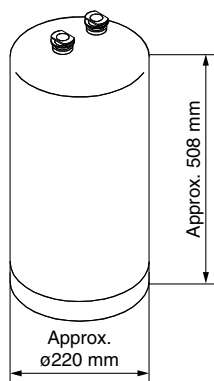

Weight: Approx. 20 kg

⑤ Insulating Material for DI Filter

When the DI filter is used at a high temperature, we recommend that you use this insulating material to protect the radiated heat from the DI filter or possible burns. We also recommend that you use this to prevent heat absorption from the DI filter and to avoid forming condensation.

Part no.	Applicable model
HRZ-DF002	Common for all models which can select the DI control kit. (option Y)

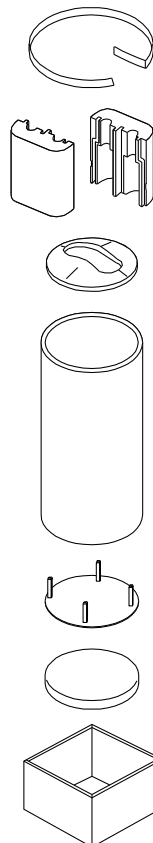

HRW Series

⑥ Contaminant Filter

A filter mounted in the circulating fluid circuit to eliminate the dust which is contained in the circulating fluid. (Filtration: 20 μm) It is provided with its own heat insulator.

Part no.	Applicable model
HRW-CF001	Common for all models
HRW-CF002	

* The internal element of the contaminant filter (Part no.: HRW-CF002) is a replacement part. The period in service depends on the operating conditions.

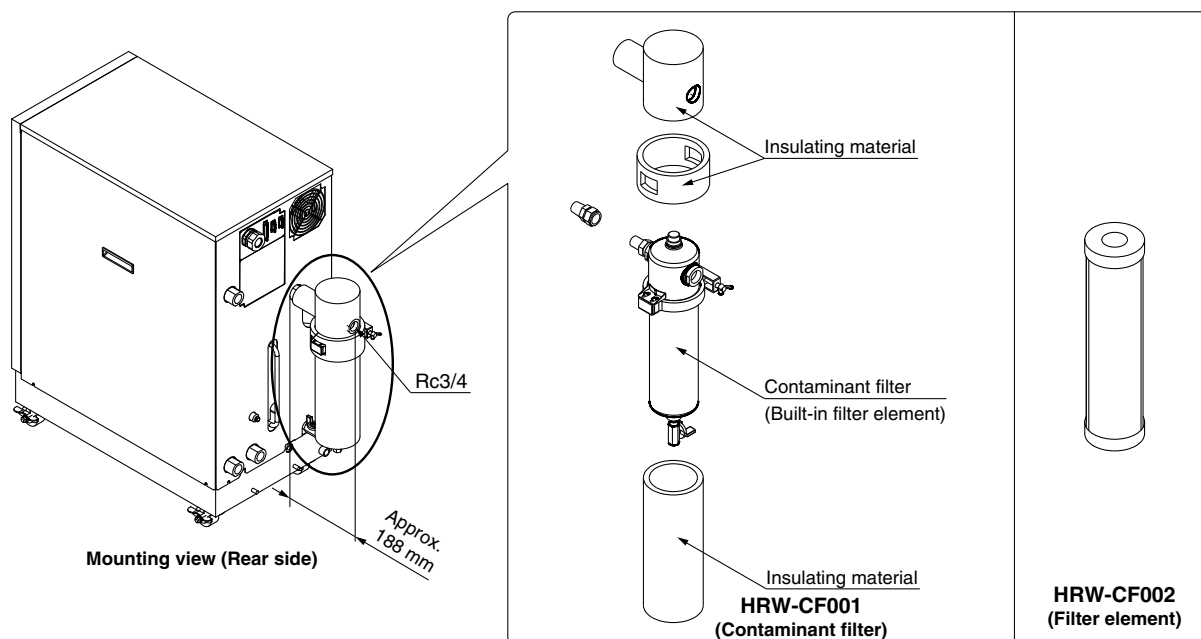

⑦ 60% Ethylene Glycol Aqueous Solution

This solution can be used as a circulating fluid for ethylene glycol-type thermo-chillers. (Capacity: 10 L)

Part no.	Applicable model
HRZ-BR001	Common for all ethylene glycol-type models

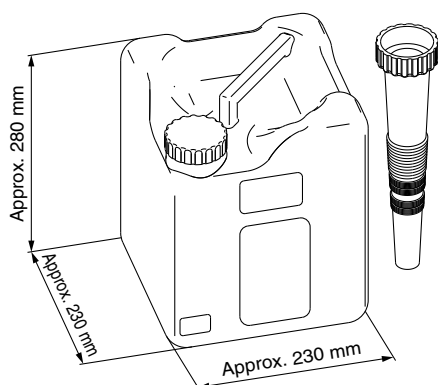

⑧ Concentration Meter

This meter can be used to control the concentration of ethylene glycol aqueous solution regularly.

Part no.	Applicable model
HRZ-BR002	Common for all ethylene glycol-type models

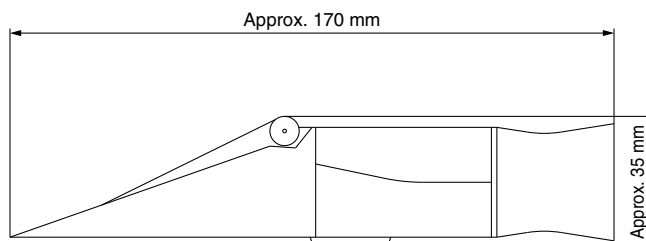



HRW Series

Specific Product Precautions 1

Be sure to read this before handling the products. Refer to page 605 for safety instructions and pages 606 to 609 for temperature control equipment precautions.

Design

⚠ Warning

1. This catalog shows the specifications of a single unit.

- For details, please refer to our "Product Specifications" and thoroughly consider the adaptability between the user's system and this unit.
- Although a protection circuit as a single unit is installed, the user is requested to carry out a safety design for the whole system.

Selection

⚠ Caution

1. Model selection

In order to select the correct thermo-chiller model, the amount of thermal generation from the user's system, the operating circulating fluid, and its circulating flow are required. Select a model, by referring to the guideline to model selection on page 469.

2. Option selection

Options have to be selected when ordering the thermo-chiller. It is not possible to add them after purchasing the unit.

Handling

⚠ Warning

1. Thoroughly read the operation manual.

Read the operation manual completely before operation, and keep the manual where it can be referred to as necessary.

Operating Environment/Storage Environment

⚠ Caution

1. Do not use in the following environment because it will lead to a breakdown.

- Environment like written in "Temperature Control Equipment Precautions."
- Locations where spatter will adhere to when welding.
- Locations where it is likely that the leakage of flammable gas may occur.
- Locations where the ambient temperature exceeds the limits as mentioned below.
 - During operation 10°C to 35°C
 - During storage 0°C to 50°C (but as long as water or circulating fluid are not left inside the pipings)
- Locations where the ambient relative humidity exceeds the limit as mentioned below.
 - During operation 30% to 70%
 - During storage 15% to 85%
- (Inside the operation facilities) locations where there is not sufficient space for maintenance.
- In locations where the ambient pressure exceeds the atmospheric pressure.

2. The Thermo-chiller does not have clean room specification. It generates dust from the pump inside the unit and the cooling fan for the unit inside.

Circulating Fluid

⚠ Caution

- Avoid oil or other foreign matter entering the circulating fluid.
- Use ethylene glycol that does not contain additives such as preservatives.
- The condensation of ethylene glycol aqueous solution must be 60% or less. If the condensation is too high, the pump will be overloaded, resulting in occurrence of "Pump Breaker Trip FLT."
- Avoid water moisture entering the fluorinated fluid.
- Use tap water (including for diluting ethylene glycol aqueous solution) which must meet the water quality standards as mentioned below.

Tap Water (as a Circulating Fluid) Quality Standards

The Japan Refrigeration and Air Conditioning Industry Association
JRA GL-02-1994 "Cooling water system – Circulation type – Make-up water"

	Item	Unit	Standard value	Influence	
				Corrosion	Scale generation
Standard item	pH (at 25°C)	—	6.0 to 8.0	○	○
	Electric conductivity (25°C)	[μS/cm]	100*1 to 300*1	○	○
	Chloride ion (Cl ⁻)	[mg/L]	50 or less	○	
	Sulfuric acid ion (SO ₄ ²⁻)	[mg/L]	50 or less	○	
	Acid consumption amount (at pH4.8)	[mg/L]	50 or less		○
	Total hardness	[mg/L]	70 or less		○
	Calcium hardness (CaCO ₃)	[mg/L]	50 or less		○
Reference item	Ionic state silica (SiO ₂)	[mg/L]	30 or less		○
	Iron (Fe)	[mg/L]	0.3 or less	○	○
	Copper (Cu)	[mg/L]	0.1 or less	○	
	Sulfide ion (S ₂ ⁻)	[mg/L]	Should not be detected.	○	
	Ammonium ion (NH ₄ ⁺)	[mg/L]	0.1 or less	○	
	Residual chlorine (Cl)	[mg/L]	0.3 or less	○	
	Free carbon (CO ₂)	[mg/L]	4.0 or less	○	

*1 In the case of [MΩ·cm], it will be 0.003 to 0.01.

○: Factors that have an effect on corrosion or scale generation.

• Even if the water quality standards are met, complete prevention of corrosion is not guaranteed.



HRW Series

Specific Product Precautions 2

Be sure to read this before handling the products. Refer to page 605 for safety instructions and pages 606 to 609 for temperature control equipment precautions.

Facility Water Supply

Warning

<Water-cooled refrigeration>

1. The water-cooled refrigeration type thermo-chiller radiates heat to the facility water.

Prepare the facility water system that satisfies the facility water specifications below.

2. When using tap water as facility water, use tap water that conforms to the appropriate water quality standards.

Use tap water that conforms to the standards shown below.

<Tap Water (as Facility Water) Quality Standards>

The Japan Refrigeration and Air Conditioning Industry Association
JRA GL-02-1994 "Cooling water system – Circulation type – Circulating water"

	Item	Unit	Standard value	Influence	
				Corrosion	Scale generation
Standard item	pH (at 25°C)	—	6.5 to 8.2	○	○
	Electric conductivity (25°C)	[μS/cm]	100*1 to 800*1	○	○
	Chloride ion (Cl ⁻)	[mg/L]	200 or less	○	○
	Sulfuric acid ion (SO ₄ ²⁻)	[mg/L]	200 or less	○	○
	Acid consumption amount (at pH4.8)	[mg/L]	100 or less		○
	Total hardness	[mg/L]	200 or less		○
	Calcium hardness (CaCO ₃)	[mg/L]	150 or less		○
Reference item	Ionic state silica (SiO ₂)	[mg/L]	50 or less		○
	Iron (Fe)	[mg/L]	1.0 or less	○	○
	Copper (Cu)	[mg/L]	0.3 or less	○	
	Sulfide ion (S ₂ ⁻)	[mg/L]	Should not be detected.	○	
	Ammonium ion (NH ₄ ⁺)	[mg/L]	1.0 or less	○	
	Residual chlorine (Cl)	[mg/L]	0.3 or less	○	
	Free carbon (CO ₂)	[mg/L]	4.0 or less	○	

*1 In the case of [MΩ·cm], it will be 0.001 to 0.01.

○: Factors that have an effect on corrosion or scale generation.

• Even if the water quality standards are met, complete prevention of corrosion is not guaranteed.

3. Set the supply pressure between 0.3 to 0.7 MPa. Ensure a pressure difference at the facility water inlet/outlet of 0.3 MPa or more.

If the supply pressure is high, it will cause water leakage. If the supply pressure and pressure difference at the facility water inlet/outlet is low, it will cause an insufficient flow rate of the facility water, and poor temperature control.

Transportation/Carriage/Movement

Warning

1. Transporting with forklift

1. It is not possible to hang this product.
2. The fork insertion position is either on the left side face or right side face of the unit. Be careful not to bump the fork against a caster or level foot and be sure to put through the fork to the opposite side.
3. Be careful not to bump the fork to the cover panel or piping ports.

2. Transporting with casters

1. This product is heavy and should be moved by at least two people.
2. Do not grip the pipings on the rear side or the handles of the panel.

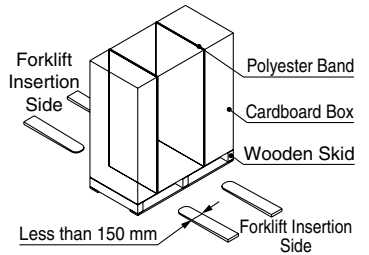

<When Packaged>

Model	Weight [kg]	Dimensions [mm] (Width x Depth x Height)
HRW002-H□	115	550 x 886 x 969
HRW008-H□		
HRW015-H1		
HRW015-H2		
HRW030-H1		
HRW030-H2	125	
HRW015-H		
HRW030-H		
HRW002-H□S	120	
HRW008-H□S		
HRW015-H1S		
HRW015-H2S		
HRW030-H1S		
HRW030-H2S	130	
HRW015-HS		
HRW030-HS		

Mounting/Installation

Caution

1. Avoid using this product outdoors.
2. Install on a rigid floor which can withstand this product's weight.
3. Please install a suitable anchor bolt for the anti-quake bracket taking into consideration the user's floor material.
4. Avoid placing heavy objects on this product.



Piping

Caution

- 1. The circulating fluid and facility water piping should be prepared by the customer with consideration of the operating pressure, temperature, and circulating fluid/facility compatibility.**

If the operating performance is not sufficient, the piping may burst during operation. Also, the use of corrosive materials such as aluminum or iron for fluid contact parts, such as the piping, may result in clogging or leakage in the circulating fluid and facility water circuits as well as other unexpected problems. Be sure to take measures to protect the product from corrosion.

- 2. The surface of the circulating fluid pipings should be covered with the insulating materials which can effectively confine the heat.**

Absorbing the heat from the surface of pipings may reduce the cooling capacity performance and the heating capacity may be shortened due to heat radiation.

- 3. When using fluorinated liquid as the circulating fluid, do not use pipe tape.**

Liquid leakage may occur around the pipe tape.
For sealant, we recommend that you use the following sealant:
SMC Part No., HRZ-S0003 (Silicone sealant)

- 4. For the circulating fluid pipings, use clean pipings which have no dust, oil or water moisture inside the pipings, and blow with air prior to undertaking any piping works.**

If any dust, oil or water moisture enters the circulating fluid circuit, inferior cooling performance or equipment failure due to frozen water may occur, resulting in bubbles in the circulating fluid inside the tank.

- 5. Select the circulating fluid pipings which can exceed the required rated flow.**

For the rated flow, refer to the pump capacity table.

- 6. For the circulating fluid piping connection, install a drain pan just in case the circulating fluid may leak.**

- 7. Do not return the circulating fluid to the unit by installing a pump in the user system.**

- 8. The facility water flow rate is adjusted automatically according to the operating conditions. In addition, the facility water return temperature is 60°C at maximum.**



HRW Series

Specific Product Precautions 3

Be sure to read this before handling the products. Refer to page 605 for safety instructions and pages 606 to 609 for temperature control equipment precautions.

Electrical Wiring

⚠ Caution

1. Power supply and signal cable should be prepared by user.

2. Provide a stable power supply which is not affected by surge or distortion.

If the voltage increase ratio (dV/dt) at the zero cross should exceed 40 V/200 μsec., it may result in malfunction.

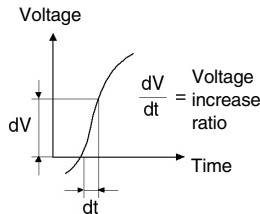

3. This product is installed with a breaker with the following operating characteristics.

For the user's equipment (inlet side), use a breaker whose operating time is equal to or longer than the breaker of this product. If a breaker with shorter operating time is connected, the user's equipment could be cut off due to the inrush current of the motor of this product.

Breaker Operating Characteristics

Common for all models

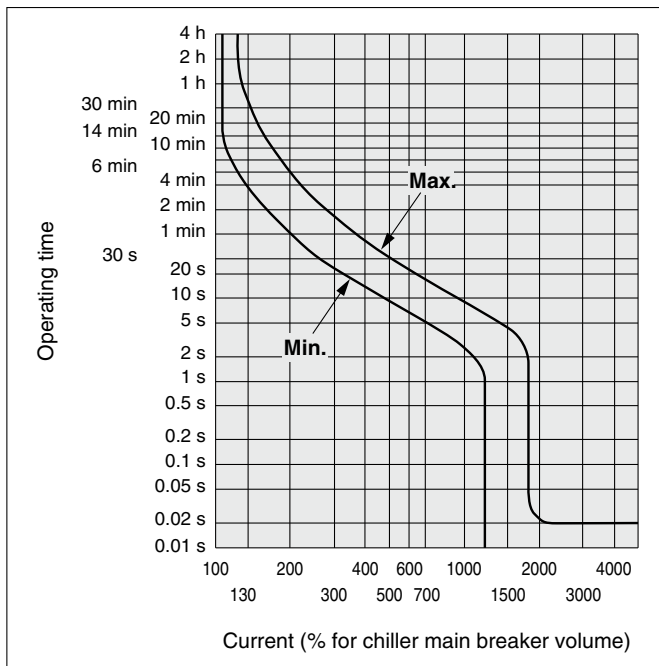

Operation

⚠ Caution

1. Confirmation before operation

1. The circulating fluid should be within the specified range of "HIGH" and "LOW."
2. Be sure to tighten the cap for the circulating fluid port until the click sound is heard.

2. Emergency stop method

In the case of an emergency, press down the EMO switch which is fitted on the front face of this product.

Maintenance

⚠ Warning

1. Do not operate the switch with wet hands or touch electrical parts such as an electrical plug. This will lead to an electrical shock.

2. Do not splash water directly on this product for cleaning. This will lead to an electrical shock or a fire.

3. When the panel was removed for the purpose of inspection or cleaning, mount the panel after works were done.

If the panel is still open, or running the equipment with the panel removed, it may cause an injury or electric shock.

⚠ Caution

1. In order to prevent a sudden product failure of the unit, replace the replacement parts every 36 months.

2. Perform an inspection of the circulating fluid every 3 months.

1. In the case of fluorinated fluids: Discharge the circulating liquid and avoid any dirty objects, or water moisture, or foreign matter entering the system.
2. In the case of ethylene glycol aqueous solution: Maintain the condensation at 60%.
3. In case of tap water, deionized water: Replacement is recommended.

3. Check the water quality of facility water every 3 months.

Regarding the water quality standards for facility water, refer to page 608.